

# ***Lift Rack Accessories***

***For Hunter wheel alignment lift racks***



# FIA Fully Integrated Alignment



Hunter lifts with FIA capabilities streamline the entire alignment process.

Direct communication between the lift and aligner automate tasks once performed by the technician manually, eliminating time-consuming trips around the vehicle and to-and-from the console.





**PATENTED**  
**WinAlign® console\***

- ✓ Centralized control of entire system
- ✓ Communicates directly with lift to set tire pressure and automatically operate turnplates and slipplates
- ✓ Guides the technician through the alignment process
- ✓ Rack Track auto-adjusts electronic movable-camera sensors to match lift height\*



*Cameras capture measurements automatically once the fourth target is installed*



**PATENTED**  
**Lift console**

- ✓ Raising the vehicle triggers the sensors to look for wheel targets\*
- ✓ Controls PowerSlide™ and Inflation Station settings on the lift console



*Optional AlignLights system turns on automatically at alignment height*



**PATENTED**  
**PowerSlide™ system**

- ✓ Slipplates and turnplates automatically lock and unlock at appropriate times\*
- ✓ Turnplate bridges automatically raise and lower at appropriate times\*
- ✓ No more struggles with lock pins



*Auto-locking turnplates and slipplates save trips around the vehicle*



**PATENTED**  
**Inflation Station**

- ✓ Automatically inflates all four tires simultaneously
- ✓ Records starting and final pressure\*
- ✓ Hose recoils to keep work area clear

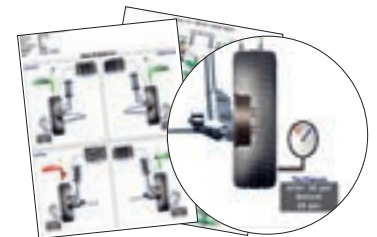

*Software tracks before and after tire pressures for the customer's printout\**



# PowerSlide™ system



The PowerSlide™ system secures and releases slipplates and turnplates with one touch. With the PowerSlide™ system, technicians no longer have to make multiple trips around the vehicle or struggle to remove and replace lock pins during an alignment.



**PATENTED**

## PowerSlide™ Turnplates

See page 7 for PowerSlide™ turnplate options.



## PowerSlide™ Slipplates



RX Lift PowerSlide™ control



Four-Post Lift PowerSlide™ control

### TIP

PowerSlide™ saves time operating as a stand-alone system, but operates most efficiently when connected to an aligner through FIA.

- ✓ Conveniently located on the lift console
- ✓ Locks and unlocks slipplates and turnplates with the touch of a button
- ✓ Automatically locks when lift is lowered\*

## PowerSlide™ upgrades

- PowerSlide™ turnplates *not* included.
- Kits include all parts needed for upgrade but no installation payment. Consult your service rep before quoting.

NEWER RX10/12A SCISSOR LIFTS	RX16 SCISSOR LIFT	NEWER L45X FOUR-POST LIFTS
20-2933-1	20-2937-1	20-3069-1
Adds PowerSlide™ capability & FIA	Adds PowerSlide™ capability	Adds PowerSlide™ capability

# Inflation Station system

The Inflation Station system inflates all four tires to a pre-selected pressure simultaneously - while you raise the lift or do other tasks!  
Saves steps and save time!



RX Lift Inflation Station control panel



Four-Post Lift Inflation Station/FIA console

- ✓ Set tire pressure at the lift console or at the aligner\*
- ✓ Automatically inflate all four tires simultaneously
- ✓ Record starting and final pressure\*\*

*Integrated inflation hoses, located at each wheel position, retract when not in use to keep the work area clear.*

*Printouts show starting and final tire pressures.\**



## TIP

Inflation Station saves time operating as a stand-alone system, but operates most efficiently when connected to an aligner through FIA.

## Inflation Station upgrades

- PowerSlide™ turnplates *not* included.
- Kits include all parts needed for upgrade but no installation payment. Consult your service rep before quoting.

	<b>NEWER RX10/12A SCISSOR LIFTS</b>	<b>RX16 SCISSOR LIFT</b>	<b>NEWER L45X FOUR-POST LIFTS</b>
Lift has no FIA features	20-2935-1	20-2938-1	20-3070-1
Lift has PowerSlide™ already	20-3038-1	20-3038-1	20-3071-1

\*Inflation Station operation at the aligner requires WA400 or WA300 series alignment console and FIA-equipped lift.

\*\*Requires FIA-equipped aligner with WinAlign 10.x software or greater

# AlignLights

The AlignLights system provides a safe and efficient LED light source underneath the vehicle without additional electrical cords.

The lights automatically switch on when the lift is raised and off when the lift is lowered.

## **20-2766-1 – for RX models**

*Only compatible on runways with AlignLights cutouts*

## **20-2993-1 – for L45x models**

*AlignLights is an ALI listed accessory for all lift models.*



*AlignLights is available for most Hunter alignment lifts as an installed option or can be retrofitted to most previously installed lifts.*

# Swing Air Jacks

Hunter Swing Air Jacks provide reliable, full-pneumatic operation.

Proven over decades of use, air-operated cylinders raise the vehicle from either the suspension or frame. Swing air jacks are engineered to handle a wide variety of vehicles and provide easy, low-maintenance service.

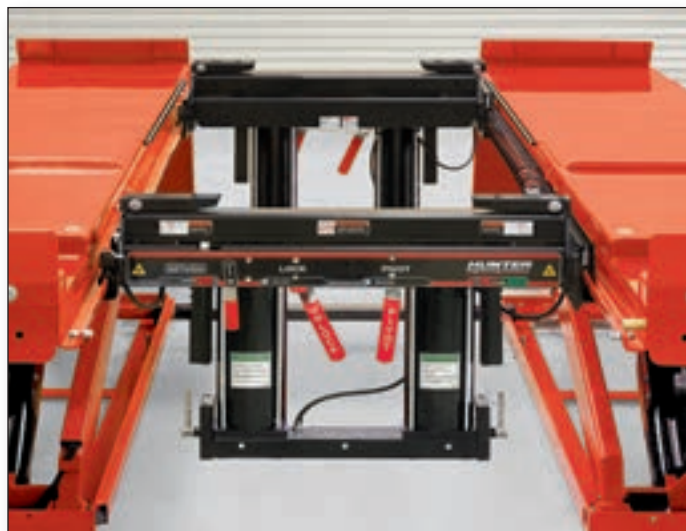

*Swing air jacks combine low drive-on height with high lifting capacity.*





**9,000-lb. Capacity,  
Triple Composite Cylinder Jack  
133-84-1**

Ideal for use with RX16, L45x lift models.



**6,000-lb. Capacity,  
Dual Composite Cylinder Jack  
133-85-1**

Ideal for use with RX-10 and RX12A lift models.

*Swing Air Jack clearances*

<b>A</b>	Clearance	1.5 in.
<b>B</b>	Max. Low Flip	16 in.
<b>C</b>	Max. High Flip	18 in.

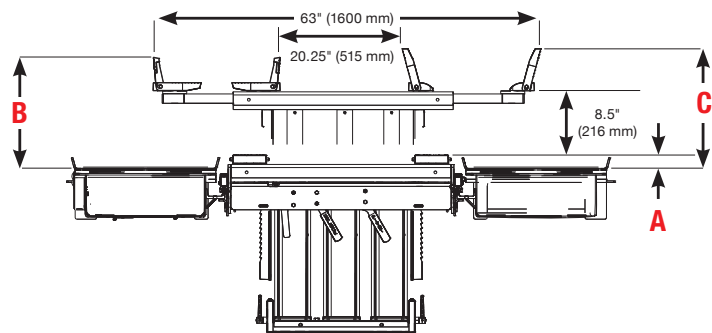

# Turnplates



## PowerSlide™ Turnplates

PowerSlide™ turnplates eliminate the hassle of removing and replacing lock pins during an alignment. Integrated bridges lower and raise as plates are locked. PowerSlide™ turnplates are an optional feature that may be added later to qualified RX and Four-Post series lifts.

<b>20-2076-1</b>	PowerSlide™ turnplates with automatic bridges	For use with camera-based alignment sensors
<b>20-2075-1</b>	PowerSlide™ turnplates without automatic bridges	For use with conventional alignment sensors



## Stainless Steel Turnplates

Resists corrosion and maintains free movement during the alignment procedure. Stainless steel construction for long, trouble-free life. No pointer.

<b>20-2532-1</b>	Stainless Steel (set of 2)	Fits 1.5" or 50 mm turnplate pockets <i>Includes guide strips</i>
<b>20-2533-1</b>	Stainless Steel, Low Friction (set of 2)	Fits 50 mm turnplate pockets <i>Includes guide strips</i>



## Painted Turnplates – 20-2531-1

Set of two turnplates for 1.5" or 50 mm turnplate pockets. Steel construction with a powder-coated paint finish. No pointer.



## Turnplate Bridge

Eases rolling compensation when rack is used with camera-based alignment sensors.

**20-2307-1** Universal Bridge for 50 mm and 1.5" turnplate pockets

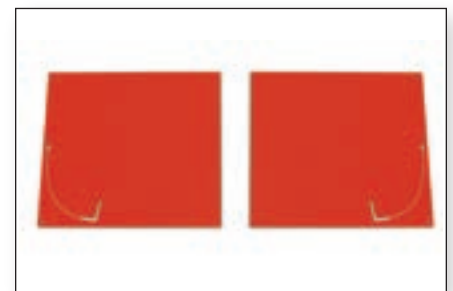

## Filler Plates

Fills turnplate pockets when turnplates are not used. 19.5" wide.

**20-2396-1** For 1.5" pockets (two included)

**20-2395-1** For 50 mm pockets (two included)



# Ramps & extensions

High-floor-slope conditions and low-ground-clearance vehicles occasionally require additional approach ramp length.

## Stage 2 RX Approach Ramp Extensions

<b>20-3113-1</b>	RX ramp extension kit (set of 2)	Adds 17.75" to the length of RX9, RX10 & RX16 Adds 5" to RX-12 & RX12A when substituted for 20-3112-1 <i>Standard on RXDC</i>
<b>20-3112-1</b>	RX ramp extension kit (set of 2)	12" extensions for RX10, RX12 and RX16 <i>Standard on RX-12 and RX12A</i>
<b>20-2169-1</b>	RX ramp extension (incl. quick-release pins)	Adds 40" to length of RX9, RX10, & RX16 Adds 27.25" to RX-12 & RX12A Adds 22.25" to RX-12-PS/IS
<b>20-2189-1</b>	RX ramp extension (incl. quick-release pins)	Adds 50" to length of RX9, RX10, & RX16 Adds 37.25" to RX-12 & RX12A Adds 32.25" to RX-12-PS/IS



## Stage 2 Four-Post Ramp Extension Kit

<b>20-1365-1</b>	Four-Post ramp extension for 22.5-in. runways	Adds 17.5" to length of ramps
<b>20-3145-1</b>	Four-Post ramp extension for 26-in. runways	Adds 17.5" to length of ramps
<b>20-2033-1</b>	Four-Post ramp extension for 22.5-in. runways	Adds 40" to the length of ramps
<b>20-3146-1</b>	Four-Post ramp extension for 26-in. runways	Adds 40" to the length of ramps

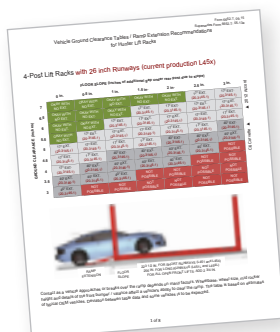

Refer to form **6652-T** for ramp extension recommendations based on vehicle ground clearance.

# Ramps & extensions cont.

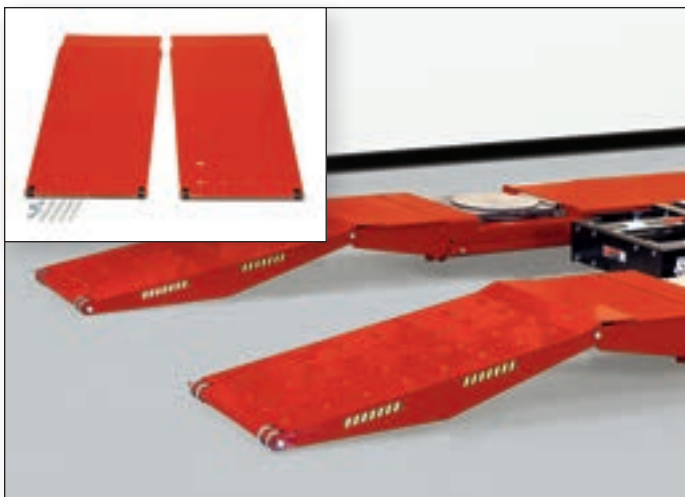

## Drive-Thru Kits

<b>20-2498-1</b>	RX10, RX12A and RX16 drive-thru kit for camera sensors	Adds 52" to overall length
<b>20-2501-1</b>	RX10, RX12A and RX16 drive-thru kit for conventional sensors	Adds 63" to overall length
<b>20-2682-1</b>	L451 / L454 drive-thru kit for 22.5-in wide runways	Adds 38" to overall length
<b>20-3135-1</b>	L451 / L454 drive-thru kit for 26-in wide runways	Adds 38" to overall length

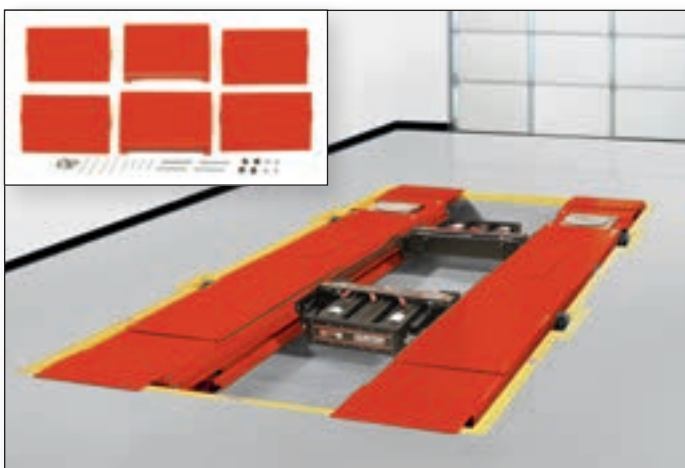

## Flush-Mount Conversion Kits

Converts surface-mount installations to flush-mount installations, using current site requirements.

<b>20-2103-1</b>	For RX-9 and RX-12 PowerSlide™ or Inflation Station models including RXDC and RX40
<b>20-2102-1</b>	For all other RX-9 and RX-12 models
<b>20-2736-1</b>	For RX10, RX12A and RX16 models

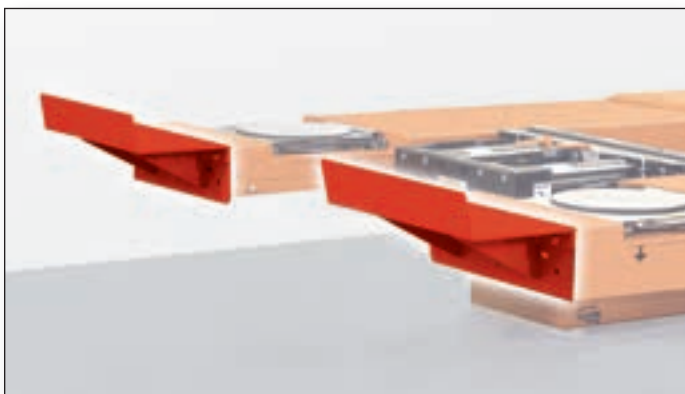

## Long Wheel Stops – 20-2497-1

For use with conventional sensors and vehicles with low spoilers.

Fits RX10, RX12A & RX16 racks  
 Adds approximately 12" in length

# Additional lift accessories

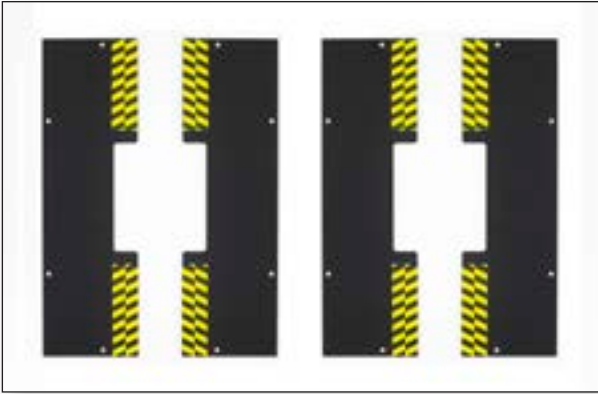

## Pit Hose Reel Cover Plates (set of 4) 20-2267-1

Cover plate for Inflation Station lifts to trim around flush-mount cut-outs.

**51-2308-1** Single pit hose reel cover plate



## Work Step – 51-1696-1

Work step makes custom steer or underhood shim work easier. Can be used with RX, L45X, L42X, L44X, RM, PN and RMHD models.

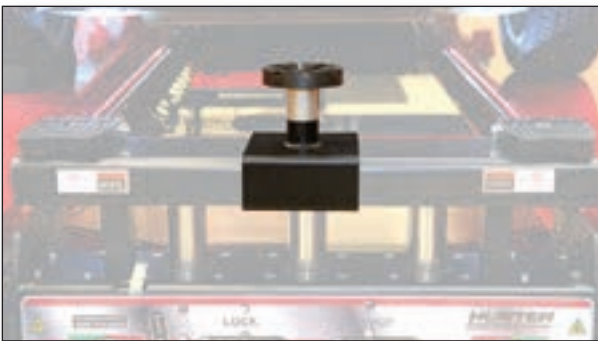

## Center Lift Jack Adaptor

**20-2854-1** (6,000 lb) **20-2853-1** (9,000 lb)

Ideal accessory for lifting from the differential or subframe on many vehicles. Includes storage bracket.

Suitable for **133-84-1** and **133-85-1** jacks only.

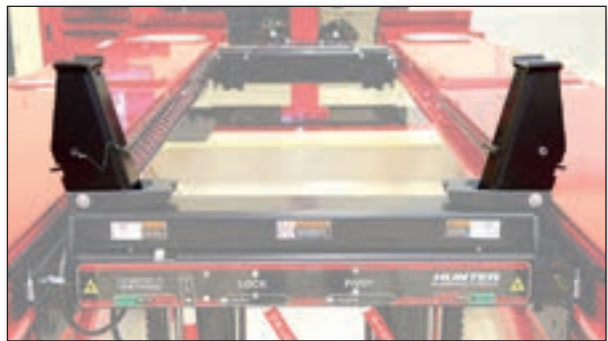

## Jack Riser Kit (set of 2) – 20-2801-1

Extends the reach of the jack to make lifting high- ground-clearance and long-wheelbase vehicles easier. Adds 4.5" to overall jack lift height.

Suitable for **133-84-1** and **133-85-1** jacks only.



## Front-Mount Power Unit Bracket – 20-3072-1

*For L45x models*

Moves power unit mounting to front of four-post column for bays with very little space.



# Additional lift accessories



## Jack Pad – 64-50-2

Rubber pads cover jack lifting points to prevent damage to the underside of the vehicle (two required).



## Wheel Chock – 22-525-2

Prevents vehicle from rolling once on the lift. Two chocks are included standard in any new lift purchase.



## Storage Bracket Kit 20-2528-1

Provides storage for wheel adaptors on console, lift or HawkEye Elite® sensor column. Simply bolts on to clip-on work step holes, no drilling required. Includes four brackets.



## Hook – 216-83-1

Suitable for brake pedal depressor.



*Be sure to check out Hunter's lift rack literature for more detailed information on each product.*

*Because of continuing technological advancements, specifications, models and options are subject to change without notice.*

*WinAlign and HawkEye Elite are registered trademarks of Hunter Engineering Company.*