



Das Werkzeug

2021

WHB21/CS/CZ/1





Strana
20 – 103

***Provozní a
díleenské zařizení***



Strana
104 – 253

Ruční nářadí



Strana
254 – 299

Momentová technika



Strana
300 – 353

Pneumatické nářadí / stroje



Strana
354 – 373

***Díleenské potřeby
Ochrana zdraví při práci***



Strana
374 – 481

Speciální nářadí
Přehled použití strana 375



Strana
482 – 504

***Jednotlivé a náhradní díly
Informace***



- **Dílenský vozík *Assistent*** Strana 33–43
- **Pracovní stoly / skříňky** Strana 44–48
- **Příslušenství dílenského vozíku / dílenského stolu** Strana 48–51
- **Dílenský vozík *Assistent* se sortimentem** Strana 52–75

- **Dílenský stůl *Assistent* se sortimentem** Strana 76–79
- **Nástrojový kufrík** Strana 80–81
- **Sady nářadí** Strana 82–84
- **Nástrojové moduly** Strana 85–103

- **Klíče na šrouby** Strana 106–118
- **Program nástrčných klíčů** Strana 119–173
 - ₃ ¼ od strany 128 □₁₀ ⅝ od strany 134 □₁₂ ½ od strany 145
 - ₂₀ ¾ od strany 164 □₂₅ 1 od strany 169
 - Nástroje **TORX**® od strany 172
- **Šroubováky/bity** Strana 174–198
- **Kleště** Strana 199–213

- **Kladiva/sekáče/důlčíky** Strana 214–220
- **Stahovací nářadí** Strana 221–230
- **Brusná, dělicí a obráběcí technika** Strana 231–235
- **Opravy závitů** Strana 236–238
- **Měřicí technika** Strana 239–240
- **Nářadí s ochrannou izolací / elektrikářské nářadí** Strana 241–252

- **Momentová technika** Strana 255–299
 - SYSTEM 5000 CT / 5000 CLT Strana 278–280
 - SYSTEM 6000 CT Strana 280–286
 - SYSTEM 7000 sTAC Strana 288–289
 - SYSTEM 6300 CT Strana 291–292

- **Momentové šroubováky** Strana 292
- **Nástrčné nástroje** Strana 293–296
- **Zkoušečky utahovacích momentů a příslušenství** Strana 296–299

- **Pneumatické nástroje** Strana 301–353
 - Rázové utahováky Strana 311–316
 - Ráčnové šroubováky Strana 316–320
 - Vrtačky a brusky (oddělování a obrábění) Strana 320–334
 - Pistole na slepé nýty Strana 334–335
 - Vyfukovací nářadí Strana 335–337
 - Zařízení pro huštění a měření pneumatik Strana 338
 - Tukové lisy, stříkací pistole, sací/foukací pistole Strana 339–340

- **Pneumatické spojovací díly** Strana 340–343
- **Pneumatické příslušenství** Strana 344
- **Akumulátorové / elektrické přístroje** Strana 348–353
 - Akumulátorové rázové utahováky Strana 348–351
 - Akumulátorové vrtačky / úhlové brusky Strana 351–352
 - Horkovzdušné ruční přístroje Strana 352–353

- **Diagnostika / endoskopická technika** Strana 359–360
- **Lampy/svitidla** Strana 361–366
- **Podlahové rohože** Strana 367
- **Chrániče vozidel** Strana 367

- **Mazací technika** Strana 368–372
- **Všeobecné dílenské potřeby** Strana 372
- **Ochrana při práci** Strana 373

- **Osobní vozidla** Strana 381–467
 - Motor Strana 381–409
 - Převodovka Strana 409
 - Olejový servis Strana 410–415
 - Servis brzd Strana 415–423
 - Podvozek Strana 424–451
 - Elektrický systém / servis baterií Strana 452–457
 - Karoserie / vnitřní vybavení Strana 458–467

- **Užitková vozidla** Strana 467–481
 - Motor Strana 467–470
 - Olejový servis Strana 470–471
 - Servis brzd Strana 471–473
 - Podvozek Strana 473–480
 - Elektrický systém / servis baterií Strana 480–481
 - Karoserie / vnitřní vybavení Strana 481

- **Jednotlivé součásti a náhradní díly** Strana 482–490
- **Všeobecné bezpečnostní pokyny** Strana 491
- **Srovnání** Strana 492–493
- **Obsah A – Z** Strana 494–497

- **Číselný seznam** Strana 498–499
- **Obchodní podmínky** Strana 500–501
- **Zlepšovací návrh** Strana 503
- **Záruka společnosti HAZET** Strana 504

HAZET No.	Strana	HAZET No.	Strana	HAZET No.	Strana	HAZET No.	Strana	HAZET No.	Strana	HAZET No.	Strana
0-111	47	600 Lg	114	802-PH	182	865	131	916 Ⓔ	148	1106 S	171
0-178	77	600 Lg	114	802-PZ	182	866 U	131	917	156	1107 S	171
0-178N	54	600 N	112	802	95, 183	867	133	917/918 KV	247	1114	170
0-179	57, 71	600 N	85, 113	802-TH	182	868	134	918	156	1115	169
0-179N	67, 69, 75	600 NA	113	803	185	869	133	919	156	1115	169
0-179NW	79	603	114	803 Lg	186	870	134	920	156	1116	169
0-1900	84, 458	603	114-115	803 Lg-PH	186	871	134	932	146	1116 Ⓔ	169
0-20	83, 244	606	115	803 Lg-T	186	880	138	953 HP	145	1116	169
0-2500	62-63, 73	606 N	116	803-PH	186	880 A	139	954 N	145	1117	170
0-2700	59	606	86, 116	803-PZ	186	880 A MGT	140, 387	958	156	1121	170
0-2900	65	609	118	803-T	186	880 E	140	958 N	156	1158	170
0-6	53	610 N	117	803-T	247	880 G	139	958-28	157		
0-7	82	610 N	117	804 VDE	247	880 G-E	141	960 MGT	132, 138, 150	1520	80
		612	118	805	187	880 G-E	141	980	151	1557	172-173
		612 N	118	805 C	187	880 GZ	139, 409	985	151	1774	230
		615 S	392	805	97, 187	880 KF	140, 387	985 S	161	1775 N	228
111	47	630	117	808	187	880 KF Ⓔ	140, 151	985	151	1775 N	228
111 L	46	630 A	118	810	184	880 KV	246	986	152	1776	226, 467
111	46	630 KV	245	810 BH	195	880 KV	102, 246	986	152	1776	226, 467
112	47	630 KV	102, 245	810 PZ	185	880 Lg	138	986 A	152	1778	230
130	46	630 KV	102, 245	810 SPC	196	880 Lg-E	141	986 KK	153	1778	230
161 T	48	630	117	810 T SPC	98, 185	880 Lg	136	986 L	152	1779	434-435
161-Z	48	650	450	810 T	185	880 MGT	140, 386	986 LgKV	247	1780	228, 435
163 F	103	650 K	451	810 T	185	880 N	134	986 SL	152, 390	1781	435
163	86-102, 155-156, 173, 249, 415	650 RF	451	810 U	183	880 N-SZ	144	986 S	90, 153	1783	225
		652	451	810 U	98, 184	880 SE	144	990	154, 390	1785	226-227
165	81	653	451	810 VDE	248	880 TZ	139	990 Lg	154, 449	1786 F	226
166 C	41	665	450	810 VDE-PH	248	880 TZ	88	990 S	162	1786 FS	227
166 N	41	666	451	810 VDE	103, 248	880 VDE	245	990 S Lg	154	1786 S	228
167 T	43			810 VDE-T	248	880 Z	138	990 S Lg	162	1786 S	226-227
167-3	42	705	450	810-PH	184	880 ZN	136	990 S	162	1787	225
167-3 S	42	715	479	810-PZ	184	880	134-135	990	90, 154	1787 F	225
173-Z	48	720	479	810	185, 248	882	135	991	154, 390	1787 F	225
177	33	730	218	810-T	185	882	135	992	154	1787 F-Z	227
177 W	44	730 HS-Z	218	821	232	885 N	135	992 H	155	1787 S	225
177 W	76-77	731	218	822	233	888 ZN	136	992 Lg	155, 390	1787-Z	227
177	52-53	740	218	823	232			992 S Lg	155	1788 N	229
178 N	34-35	741	218	824	232	900	149	992 T	95, 155	1788 N	229
178 N	54	745	219	825	232	900 AZ	150	992	155	1788 T	230, 468
179 N	36-37, 56-61, 66-67	745 A	219	828	188, 465	900 AZ	146	995 S	163	1788 T	229
179 N XL	38-39	746	219	828 Lg	188, 465	900 E	151	1000	165	1789	227
179 N XL	68-73	747	219	828 Lg-T	189, 464	900 HL	147	1000 AZ	166	1789 N	381, 456
179 N XXL	40	748 Lg B	219	828	98, 189	900 KF	150, 387	1000 AZ	164	1790	435, 473
179 N XXL	74-75	750	219	828-T	188	900 KV	247	1000 S	167	1792	226
179 N	64-65	751 HS	220	829 KK	189	900 Lg	149	1000 S Lg	167	1802	202
179 NW	45	751 K HS	220	829 KK T	189	900 Lg	89	1000 S-Z	168	1802 M	202
179 NW	78-79	751 L HS	220	830	187, 249	900 MGT	150, 387	1000 Z	164	1802 VDE	249
190 L	81	751	219	840	236	900 S	157	1000 Z	164	1803	202
190	80	752	210	841	236	900 S Lg	157	1000	90, 164	1803 M	202
195	367	753	209	842 AG	237	900 S Lg 6	157	1002 Z	164	1803 VDE	249
196	367	755	209	842 AG	237	900 S Lg Ⓔ	160	1002	164	1804 N	203
196 VDE	251	757	209	842 N	237	900 S-E	161	1003	168	1804 VDE	249
196	367	758	209	844	236	900 S Ⓔ	163	1004 S	167	1810	204
197	368	759 N-VDE	250	844	237	900 S	94, 157	1005 S	168	1811	205
198	369	760	204	847	238	900 S-Z	163	1006 S	168	1816	203, 465
198-1	369	760 N	204	848 Z	139, 151	900 SK	157	1007 S	168	1816 VDE	250
198-10	414-415	772	450	849 IG	238	900 SZ	160, 448-449	1010	166	1826 VDE	250
199	369, 371-372	772	480	849	238	900 SZ 6	160-161	1012	166	1841 A	203
		790	391	850	131	900 SZ	160, 449	1014	165	1841 A VDE	250
		791	391-392	850 A	131	900 TZ	150	1015	165	1841 B	203
		792	391	850 E	132	900 Z	149	1015	165	1841 B VDE	250
		794	391	850 HL	130	900 Z	146	1016	165	1841 MA	203
		794 U	391	850 Lg	131	900	145, 151	1016 Ⓔ	165	1841 MB	203
		795	391	850 Lg-GE	132, 408	901 S Lg	158	1016	165	1845 A	205
		796	423	850 TZ	132	902 S Lg	158	1017	167	1845 B	205
		797	423	853	128	903 S Lg	158	1018	167	1845 C	205
		798	210-213, 400-403	854 T	128	903 S Lg 6	159	1021	167	1845 D	206
		798	99, 213, 403	854	128	903 S Lg	158	1058	167	1845	99, 206
		799	463	855	129	903 SPC	158	1100 S	170	1846 A	206-207
				856	129	904 S Lg	159	1100 S Lg	170	1846 B	207, 423
				858	133	905 S Lg	159-160	1100 S Lg	171	1846 C	207
				863	130	906	145	1100 S-Z	171	1846 D	207
				863-Bit	130, 195	906	145	1100 Z	169	1847	208, 447-448
				863-Bit	129, 193	914	149	1104 S	171	1849	204, 385-386
				863 Ⓔ	131, 195	915	149	1105 S	171	1850	202
						916	147-148			1850 M	202

Číselný seznam

☉ = Samostatný / náhradní díl 📦 = Sada / Sortiment

HAZET No.	Strana	HAZET No.	Strana	HAZET No.	Strana	HAZET No.	Strana	HAZET No.	Strana
1850 VDE	249	2140	216	2520	463	4658	251	4971	423, 472-473
1851	202	2141	216	2527-5	413	4670 📦	453-454, 480-481	4972 📦	473
1851 M	202	2142	216	2527-8	393	4671	454	5000 CLT	280
1860 VDE	250	2143	217	2528	413	4672	454-455	5000 KV	252
1862	250	2144	217	2530	388	4673	455	5000-3 CT	278
1863	250	2145	240	2534	220	4674	455	5200-3 CT	279
		2147	240	2534-1	465	4680	409		
1905	458	2150	231	2540	381	4682	234, 408	6000 CT	290
1911	458	2151	360	2561	392-393	4684	408	6000-1 CT	280-282
1917 N	458	2152	452	2567	413	4685-1	474	6000-1 CT-US	283
1918 N	458	2152 N 📦	452	2579	390	4685-2	474	6001 📦	290
1919 N	459	2153	452	2582	419			6100 ☉	287
1920 N	459	2154	239	2583	436	4760	389		
1921	459	2154 N	239	2584	446	4760 📦	389	6200-1 CT	284-285
1922	459	2155	240	2584-1	395	4766	387-388	6290 📦	286
1923	459	2155 N	239	2584-8	415	4767 AKF	388	6292 📦	286
1927	459	2156	251	2587	382	4793 📦	407		
1928 K	459	2156 VDE	251	2588	383	4795	407	6300	291-292
1929-1	459	2157	233-234	2588 📦	382-384	4797	469	6396	293
1930	459	2158	233	2592	456	4797 📦	395	6399	292
1930-1	459	2160	369	2593	434	4798	396-399		
1931	459	2162	342, 369-371	2597	464	4798 📦	396, 398-399	6400 📦	286
1932	460	2163	370	2597-Z	464			6401	293
1934	461	2164 📦	220	2598	464	4800	404-407, 470	6401 S	293
1934 N	461	2165	220			4800 📦	404, 469	6401-1	293
1935-1938 K	462	2166	220	2710	434	4801	403	6408	294
1940-1943	462	2168	467, 469	2730	419	4801 📦	403	6413	294
1944-1950	462	2168-2	392	2756	409	4802	470	6414	295
1951	217	2169	410-412, 470-471	2760	413	4810 C	407	6420	295
1952	217	2169 📦	412	2780	434	4812	359-360	6423	295
1952 ☉	217	2170	412	2784	166, 415, 471	4812 N 📦	359	6430	295
1953	216	2171	412, 471	2784 S	481	4812 📦	359	6450 C	295
1953-Z	216	2172	412-413	2784 SR	481	4850	466		
1959	462-463	2174	409	2784 📦	471	4852 📦	466	6602	293
1960	460	2175 N	372	2788	384			6606 D	296
1961	460	2180	234	2797	465	4900	424-427	6612 C	296
1963	461	2181	234	2797-2	465	4900 📦	424, 427	6630 C	296
1964	460	2183	205			4902 📦	431	6690	296
1965	463	2191	417	2849	468	4903	432	7000 sTAC	288-289
1965 📦	463	2191 📦	417	2850	168, 467	4910	433		
1967	231, 462	2193	418	2871	472	4910 📦	433	7900 E	297-298
1975	360	2193 ☉	418	2871-E 12	468	4912	436	7920 E	298-299
1976	360	2193 📦	418	2872	472	4912 📦	436		
1977	360	2195	471	2872 FS	472	4915	434	8501	132
1979	361-366			2872 SZ	472	4925 📦	445-446	8501 KK	133
1980 N	233	2200 📦	129, 193			4929 📦	446	8502	133
1981	233	2204	194	2901 G	416	4930	436-438	8503	133
1987	373	2206	197	2991	392	4930 📦	436	8506	133
1987-5	373	2208	194			4931 📦	438	8507	133
1988	372	2210	197	3047	448	4932	437-438	8508 S	134
1990 📦	352-353	2211	194	3087	382	4934	438, 440		
1991	360	2212	197			4934 📦	439-440	8801	142
		2215	194	3420	414	4935	443, 449	8801 A	142
2025 X	48	2216	194	3488 📦	384	4937	475-479	8801 K	142
2025 X 📦	48	2217	197			4937 📦	474-475, 477-478, 480	8801 K-KV	246
		2218	197	3702	414			8801 KK	143
2100	190	2223	194	3703	414	4954	419	8801 📦	142
2100 📦	190	2223 Lg	194, 467			4956	420	8802	143
2105 Lg	190	2224	197	4501	394	4960 F 📦	443	8802 KV	246
2105 Lg 📦	191	2224 S Lg	197	4550	393, 468	4960 R 📦	444	8802 KV-Lg	246
2115	191	2225	194-195	4555	393	4960 V 📦	444	8803	143
2115 📦	191	2225	194-195	4556	393	4960 📦	443	8806	143
2116 Lg 📦	191	2238	196	4558	468	4961 N 📦	444	8807 S	144
2119	231	2239	196	4560	393	4963	416	8808	143
2120	231	2240 N 📦	193	4561	394	4964	416	8808 Lg	143
2122	232	2250	133, 143, 156, 196, 198	4562	403	4968	232, 235, 416, 418-419, 421, 423	8808 Lg KV	246
2123	231	2255	196	4590	394	4968 📦	416, 420-421	8808 S	144, 198
2126	238	2264	198	4590 📦	394			8812 U	138
2128	231	2265	196	4591	395	4969	472	8814	137
2130	235	2272	198			4969 📦	421	8815	136-137
2131	235, 385	2272 📦	197	4618	414	4970	422-423	8816 ☉	137, 198, 294
2132	217			4641 📦	456	4970 📦	421-422		
2133	217	2304	196	4650	452-453				
2134	218			4655	457				
2135	218	2505	387	4656	251				
2139	216								

☉ 482-490

Vysvětlení symbolů

Struktura objednačního čísla HAZET:	
-	U jednotlivého výrobku je za spojovníkem [-] např. velikost klíče Příklad: 600 N-17 → velikost klíče 17 mm
/	U sady nebo sortimentu je za lomítkem [/] uveden počet dílů v sadě
A	Americký rozměr (rozměr v palcích)
S	Pro strojní manipulaci (např. rázový šroubovák)
Z	Dvojitý šestihřanný profil
G	S kloubem
KK	S kulovou hlavou
K	Krátké provedení
Lg / TZ	Dlouhé, resp. hluboké provedení
S Lg	Velmi dlouhé provedení
T	Pro šrouby s vnitřním TORX
E	Pro šrouby s vnějším TORX
PH	Pro šrouby s křížovou drážkou
PZ	Pro šrouby Pozidriv
L	Prázdný, např. prázdná skříňka na nářadí
H / HL	V držáku / držák, prázdný
P / PL	V plastové vložce / vložka, prázdná
K / KL	Ve skříňce na nářadí, kufru / skříňka, prázdná
R	Na kroužku
VDE	Nářadí s ochrannou izolací
MgT	S magnetem
IG	Pro vnitřní závity
AG	Pro vnější závity
X	Materiál nerezová ocel
N	Nové provedení při změně modelu

Struktura tabulek	
EAN-No. 4000396+	EAN = European Article Number
B	Šířka v mm
L	Délka v mm
d d ₁ d ₂	Průměr v mm
l ₁	Délka čepele v mm
l ₂	Celková délka v mm
M	Metrický závit
s	Velikost klíče v mm, resp. palcích
sb	Rozsah upínání v mm
st	Hloubka upnutí v mm

Struktura tabulek	
T	Hloubka v mm
t	Zatížení v tunách
	TORX Velikost v mm
	Ovládací síla v kg
	Počet dílů v sadě / sortiment

Vysvětlení piktogramů	
	Možnost dodání jednotlivých dílů (strany 482–490) Nezapomeňte také na náš obchod s náhradními díly www.hazet.de/ersatzteil-shop
	Pro šrouby s drážkou
	Pro šrouby s křížovým profilem (PH)
	Pro šrouby Pozidriv (PZ)
	Pro šrouby s vnitřním šestihřanem
	Pro šrouby s vnějším šestihřanem
	Pro šrouby s vnitřním TORX
	Pro šrouby Tamper Resistant TORX (vnitřní TORX – šrouby s vedením čepu)
	Pro šrouby s vnějším TORX
	TORX je značka firmy Acument Intellectual Properties LLC. HAZET je majitelem výrobní licence pro Nářadí TORX
	Pro šrouby s vnitřním tisícíhřanem (XZN)
	Pro šrouby s vnitřním tisícíhřanem s čepem
	Pro šrouby s vnitřním drážkovým profilem (RIBE CV)
	Pro šrouby Polydrive
	Pro šrouby s vnitřním 5hvězdičkovým profilem s čepem
	Šestihřanný TRAKČNÍ PROFIL
	Dvojitý šestihřan TRAKČNÍ PROFIL
	EN/IEC 60900
	Jmenovitý rozměr 6,3
	Jmenovitý rozměr 10
	Jmenovitý rozměr 12,5
	Jmenovitý rozměr 20
	Jmenovitý rozměr 25
	Vnitřní čtyřhran
	Vnější čtyřhran
	Vnitřní šestihřan
	Vnější šestihřan

Vysvětlení piktogramů	
	Zásuvné uchycení u momentových klíčů
	Pohon u nástrčných momentových klíčů
	Karoserie
	Pohon
	Podvozek Nápravy/tlumiče Kola / spojovací tyče
	Servis olejů
	Výfukový systém
	Převodovky/hřídele
	Elektrická část motoru
	Zapalovací svíčka Žhavicí svíčka
	Hlava válců Ventily
	Zkušební přístroje
	Motorový blok Čerpadlo chladicí kapaliny Hadicové spoje
	Rozdělovač zapalování Alternátor/generátor
	Přídavné agregáty Zásobování palivem Karburátor/vstřikovač
	Spojka
	Startér/spouštěč
	Baterie
	Píst
	Řízení
	Brzdy
	Obecné dílenské vybavení
	Osobní vozidla
	Užitková motorová vozidla
	Zemědělské stroje
	Motocykly
	Průmysl
	Letectvo a kosmonautika
	INFORMACE HAZET TECHNICKÝ SERVIS Další informační materiály na webu www.hazet.de → Videoklipy H.I.T.S.
	Endoskopy / inspekční technika
	Samoobslužné balení
	Modrá HAZET Zapsaná ochranná známka Společnosti (RAL 660-2 efekt)

Další piktogramy jsou vysvětleny na adrese www.hazet.de

Kontaktní údaje

Závod 1

Poštovní adresa:

✉ 10 04 61 · 42804 REMSCHEID

Adresa pro návštěvy:

Güldenwerther Bahnhofstraße 25 – 29
42857 REMSCHEID

☎ +49 (0) 21 91 / 7 92-0

FAX sekretariát vedení společnosti +49 (0) 21 91 / 7 92-100

FAX tuzemsko +49 (0) 21 91 / 7 92-375

FAX export +49 (0) 21 91 / 7 92-400

www hazet.de

e-mail info@hazet.de

Závod 2

Industriestraße 46 · 52525 Heinsberg

☎ +49 (0) 24 52 / 1 08-0

FAX +49 (0) 24 52 / 1 08-100

Závod 3

Am Langen Siepen 13 – 15 · 42857 Remscheid

FAX nákup +49 (0) 21 91 / 7 92-700

Závod 4

Vieringhausen 85 · 42857 Remscheid

Servisní centrum

Güldenwerther Bahnhofstraße 17 · 42857 Remscheid

ZÁVOD HAZET – Hermann Zerver GmbH & Co. KG · Wuppertal · HRA 17574

Os. ruč. spol.: Zerver Verwaltungsges. mbH. · Wuppertal HRB 11054

Jednatel Matthias J. Hoffmann, Guido Schmidt

DIČ DE 120803534

Technické poradenství

☎ +49 (0) 21 91 / 7 92-333

FAX +49 (0) 21 91 / 7 92-373

e-mail anwendungstechnik@hazet.de

Servisní centrum

Servisní centrum HAZET je pracovištěm pro přímý kontakt a koordinaci služeb týkajících se našich produktů.

Adresa:

HAZET-WERK

Service-Center

Güldenwerther Bahnhofstraße 17
42857 REMSCHEID

☎ +49 (0) 21 91 / 7 92-355

FAX +49 (0) 21 91 / 7 92-523

e-mail service-center@hazet.de

Nejlepší poprodejní servis s krátkými čekacími dobami a kompletní kompetencí společnosti HAZET dostanete v našem speciálně zřízeném servisním centru.

Servisní centrum HAZET nabízí následující základní služby:

- Opravy, seřízení, kalibraci a certifikaci momentových klíčů HAZET
- Provedení servisních činností u momentových klíčů, pneumatického nářadí, dílenských vozíků a ostatního katalogového programu HAZET
- Krátké čekací doby
- Servis sledování měřidel pro momentové klíče
- Kontaktní osoba pro servisní záležitosti



Inovativní výrobní kompetence
Vytváří a vyrábí

 **Made in Germany**



**863 HP · 863 HP B · 8816 HP
916 HP · 916 HP L · 916 HP Lg**

Jemnozubé přepínací ráčny

863 HP · 863 HP B $6.3 \frac{1}{4}$ 120 Nm · 90°

8816 HP $10 \frac{3}{8}$ 400 Nm · 90°

916 HP · 916 HP L $12.5 \frac{1}{2}$ 1000 Nm · 90°

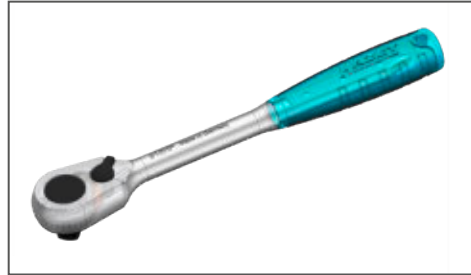

SYSTÉM 7000 sTAC

Elektronické momentové /
úhlové klíče, 1 – 1000 Nm, ± 1 %

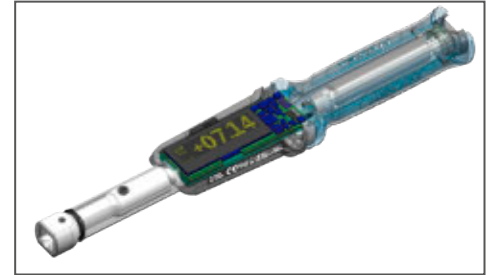

Vývoj



Výroba

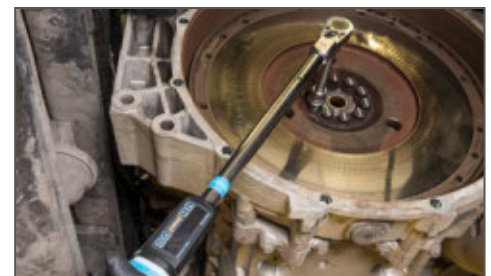

Použití

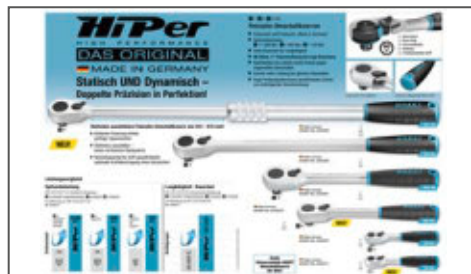

Marketing



Das Werkzeug



Assistant

179 N XL

Konzept dílenského vozíku
ve 4 variantách



760-2

Univerzální kleště s
ovládáním rychlonastavovací pákou



600 Lg

Očkoplochý klíč,
extra dlouhý, s 10–41 mm

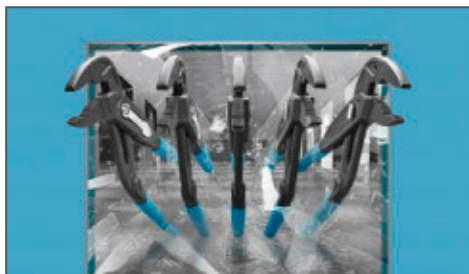
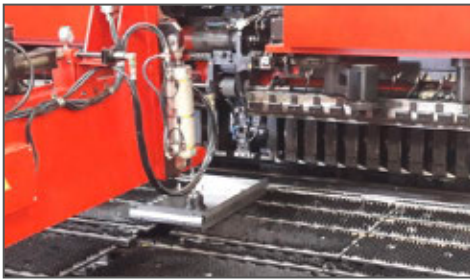
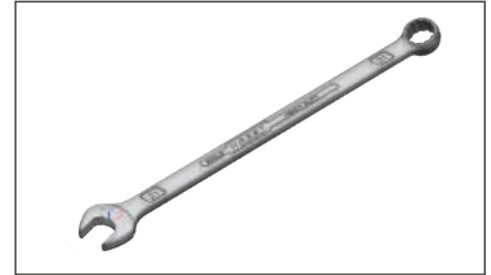
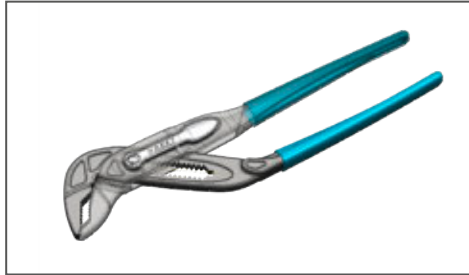



HAZET – ohodnocení a ceny



15x za sebou vítěz ceny „Best Brand Awards“!

Nejoblíbenější značka „Best Brand“ v kategorii nářadí, zvolená čtenáři časopisu Motorrad v letech 2006 až 2020!



Nářadí HAZET se používá pro:



ALFA ROMEO · AUDI · BAYER · CITROËN · DACIA · DAF · FENDT · FIAT · FORD · HARLEY-DAVIDSON · HONDA · HYUNDAI · JAGUAR · JEEP · KIA · LAND ROVER · LUFTHANSA · MAN · MAZDA · NISSAN · RENAULT · SAAB · SCANIA · SEAT · ŠKODA · SUBARU · SUZUKI · TELEKOM · TOYOTA · TRUMPF · VOLKSWAGEN

HAZET – doporučení



**Přizpůsobená sada nářadí
– doporučeno firmou BMW –**



PORSCHE
MOTORSPORT



**PORSCHE
MOTORSPORT
se spoléhá na:**

**HAZET Servisní
díleňské vozíky a
sady nářadí**

Výrobní kompetence

Vývoj – výroba – logistika

Vývoj a konstrukce

Závod 1, Remscheid



Kovárna

Závod 1, Remscheid



Výroba nářadí a zápustek

Závod 1, Remscheid



Výroba

Závod 1, Remscheid



Galvanika

Závod 2, Heinsberg



Výroba

Závod 1, Remscheid



Ručíme za naše řešení – od nápadu až po sériovou výrobu

Společnost HAZET má více než 150 let zkušeností s vývojem a výrobou ručního nářadí, dílenských vozíků a speciálního nářadí ve třech závodech v Remschaidu a v jednom závodě v Heinsbergu, a je proto jedním z předních výrobců produktů pro profesionální použití v průmyslu, automobilové a letecké technice.

Výroba

Závod 2, Heinsberg



Robotická výroba polotovarů

Závod 2, Heinsberg



Zpracování plechů výroba dílenských vozíků *Assistent*

Závod 3, Remscheid



Práškové lakování

Závod 3, Remscheid



Montáž momentových klíčů

Závod 4, Remscheid



Logistické středisko

Závod 2, Heinsberg



Zajištění kvality a trvalá udržitelnost

System řízení HAZET pro kvalitu – životní prostředí – energii



„V našem rodinném podniku se zaměřujeme kromě hospodářských cílů i na výkony pro životní prostředí a společnost, abychom jednali s trvalou udržitelností po další generace.

Je pro nás samozřejmé zaujmout funkci vzoru a integrovat potřebné povědomí o odpovědnosti ve věcech ochrany a zachování životního prostředí do podnikání. Proto i při výběru našich dodavatelů a poskytovatelů služeb klademe velký důraz na zachování našich standardů. Také u bezpečnosti na pracovišti klademe laťku velmi vysoko, neboť naši pracovníci jsou naším nejdůležitějším statkem.“

Vaše vedení společnosti HAZET

Opatření pro trvalou udržitelnost



Zelený proud



Používání oceli z Německa (šetření životního prostředí díky kratším přepravním cestám)



Šetření zdrojů



Energetické hodnocení



Podíl vlastní výroby cca 80 %



Bezpečnost na pracovišti



Průběžná optimalizační opatření



Vyznamenání Ökoprofit (efektivní využívání zdrojů a hospodárnost)



Certifikát ISO 14001 (norma environmentálního managementu s důrazem na proces neustálého zlepšování)



Klimainvest Green Concepts GmbH potvrzuje pro náš závod 2 Heinsberg odběr ekologického proudu výhradně ze zařízení obnovitelných energií



Papír FSC (papír z odpovědných zdrojů)
Použití u obalů a katalogů



Certifikát ISO 50001 (energetický management s důrazem na nárůst energetické účinnosti)



PARTSLIFE Ekologická cena za trvale udržitelný celkový koncept řízení ochrany životního prostředí

Jednotné nejvyšší požadavky na kvalitu od nápadu výrobku až po poprodejní servis

Programy Hightec

k simulaci např. procesů kování

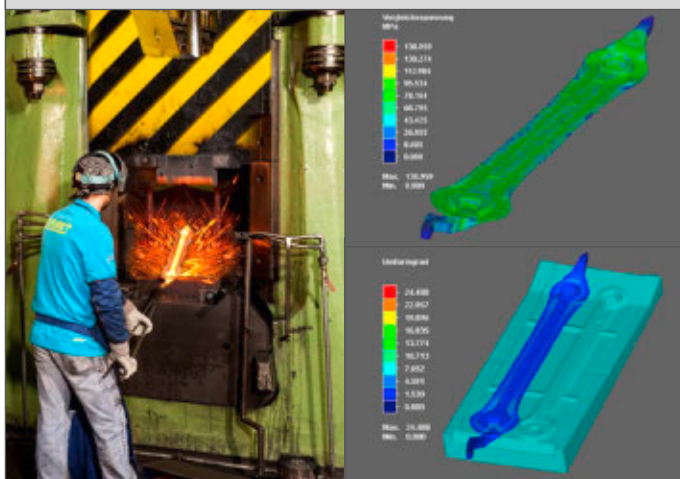

Prototypování –

Pro kontrolu prvních konstrukčních návrhů a funkcí



Maximální preciznost

a přesnost všech výrobních procesů



Testy životnosti –

Kromě vysokých zatížení se naše zajištění kvality zaměřuje na dlouhodobé testy



Vlastní kalibrační laboratoř DAkKS

a cejchovna HAZET

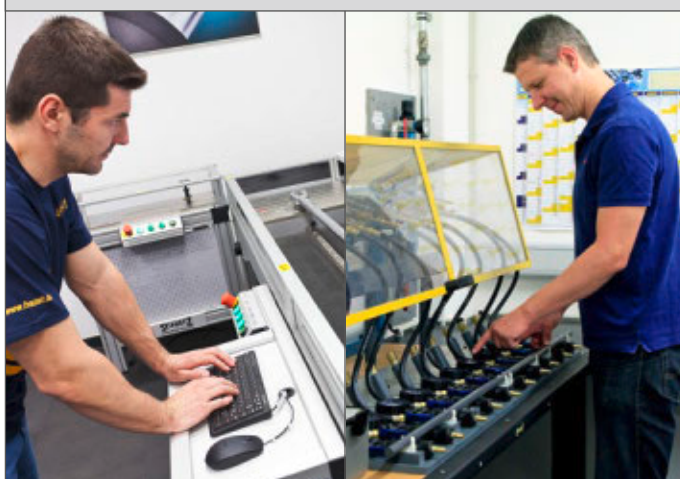

Servisní centrum –

servis i pro nejlepší poprodejní servis dlouho po nákupu!



Online obchod s náhradními díly

Svět HAZET

Prezentační a školicí centrum na ploše 600 m²



Veletrhy a výstavy

65x za rok lokálně v tuzemsku i zahraničí



20 informačních vozů v tuzemsku i zahraničí

pro přímou péči o naše zákazníky



Kompetentní odborné poradenství

Mobilní řešení problémů



Vlastní kalibrační laboratoř DAkKS

Akreditace podle normy
DIN EN ISO/IEC 17025



Integrovaný systém řízení

kvality, ochrany životního prostředí a energie podle norem DIN ISO 9001, DIN EN ISO 14001 a DIN EN ISO 50001



Stručný portrét společnosti



- Společnost HAZET založil v roce 1868 Hermann Zerver.
- Název značky „HAZET“ má své kořeny ve vyhláskovaných iniciálách zakladatele: „H“ (HA) jako Hermann a „Z“ (ZET) jako Zerver.
- Společnost HAZET je rodinnou firmou vlastněnou pátou generací.

Výrobní závody

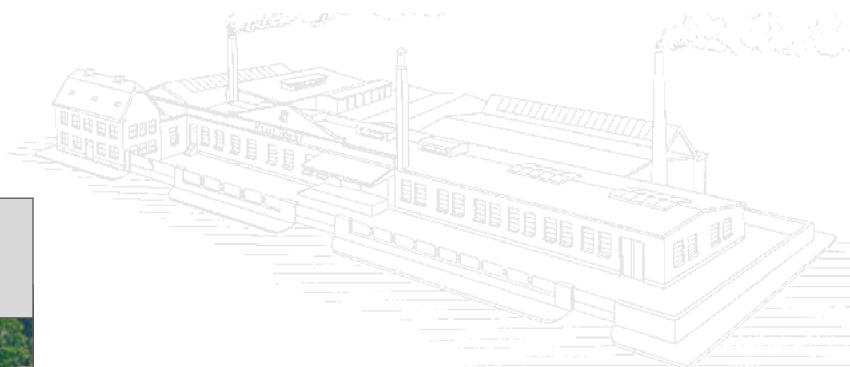

Závod 1 · Remscheid

Kovární, výroba a správa



Závod 2 · Heinsberg

Logistické centrum a výroba například
přepínacích ráčen a hlavíc nástrčných klíčů



Závod 3 · Remscheid

Zpracování plechů, zařízení pro práškové
lakování a výroba dílenských vozíků *Assistent*



Závod 4 · Remscheid

Momentová technika



Nástrojové moduly



163-542/18 → 102	163-548/14 → 101
163-543/18 → 102	163-570/24 → 94
163-544/26 → 103	163-571/22 → 89
163-545/41 → 102	163-580/18 → 102
163-546/12 → 103	

Koš na papír 179 N



179 N-33 → 50

Oddělovací plechy 161 T



161 T-179 N/4 H	→ 49
161 T-179 NXL/5 H	→ 49
161 T-179 NXXL/6 H	→ 49
161 T-395 x 60/5	→ 48
161 T-395 x 120/5	→ 48

Přepínací ráčna pro bity HiPer · jemně ozubená 863 HP



863 HP B → 195

Přepínací ráčna HiPer · jemně ozubená 8816 HP



8816 HP → 137

Přepínací ráčna HiPer · jemně ozubená · dlouhá 916 HP L



916 HP L → 148

Přepínací ráčna HiPer · jemně ozubená · výsuvná 916 HP Lg



916 HP Lg → 148

Sada nástrčných klíčů 953 HP



953 HP → 145

Nástrčná hlavice 986 L

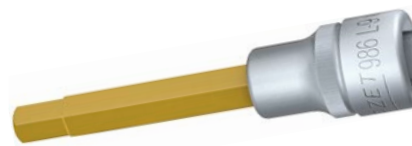

986 L-4 ... -14 → 152

Novinky a doplňky 2021



**Nástrčná hlavice
986 SL**







986 SL-4 ... -14 → 152

**Šroubovák s T-rukojetí
828 Lg (T)**





828 Lg-6 → 188 828 Lg-T 40 → 189

**Šroubovák s T-rukojetí
829 KK**



829 KK-2 ... 8 → 189 829 KK/7 → 189

**Šroubovák s T-rukojetí
829 KK-T**



829 KK T-T 9 ... T 40 → 189 829 KK T/7 → 189

**Ploché kleště
1816 K-1**



1816 K-1 → 203

**Štípací nářadí na dřevo
2132 – 2135**

2132-600 → 217 2134-1250 → 218
2133-1250 → 217 2135-3000 → 218

**Šroubové klíče · s ochrannou izolací
450 KV · 630 KV**

450 KV-7 ... 32 → 245 630 KV-7 ... 32 → 245



**Nástrčná hlavice · s ochrannou izolací
880 KV · 8801 K · 8802 KV · 8808 Lg-KV
900 KV · 986 Lg-KV**





880 KV-6 ... 22 → 246 8808 Lg-8 KV ... 12 KV → 246
8801 K-5 KV ... 6 KV → 246 900 KV-10 ... 32 → 247
8802 KV-T 10 ... T 50 → 246 986 Lg-4 KV ... 10 KV → 247
8802 KV-Lg-T 10 ... T 50 → 246

**Momentový klíč · s ochrannou izolací
SYSTEM 5000 KV**

5108 KV → 252 5121 KV → 252
5109 KV → 252

Novinky a doplňky 2021

**Momentový klíč
SYSTEM 5000-3 CT**



5111-3 CT → 278

5143-3 CT → 278

**Momentový klíč
SYSTEM 5200-3 CT**



5290-3 CT → 279

5292-3 CT → 279

**Sadu nástrčného náradí
6400 CD**



6400 CD/29 → 286

**Twin Turbo Rázový utahovák
9012 ATT**



9012 ATT → 312

**Twin Turbo Rázový utahovák
9013 Lg TT**



9013 Lg TT → 314 / 315

**Twin Turbo Rázový utahovák
9014 TT**



9014 TT → 315

**Otloukač rzi
9035 M-5**



9035 M-5-333 →

**LED svítilny
1979**



1979-11 → 361
1979 NW/3 → 364

1979 W-11 → 362
1979 W-11/3 → 364

**Klíč na palivové filtry
2168**



2168-2 → 392

Novinky a doplňky 2021

**Klíč na olejové filtry
2169**



2169-76 B → 412

**Klíč na olejové filtry
2169**



2169-8 A → 412

**Ovládací nástroj svorky Henn
4562**



4562-2 → 403

**Tester brzdové kapaliny
4954**



4954-2 → 419

**Sada nástrojů pro zpětné nastavení
brzdového pístu · pneumatická
4970 P**



4970 P-1/4 → 422

**Kleště na slepé nýty
1963**



1963-2 → 461

**Rázový očkový klíč · dvojitý šestihran
se 2 nárazovými plochami
2784 SR**



2784 SR-1 → 481

**Vratné zařízení pro brzdy
4971**



4971-12 → 473





Dílenský vozík *Assistent*

33–43

Pracovní stoly / skříňky

44–48

Příslušenství dílenského vozíku / dílenského stolu

48–51

Dílenský vozík *Assistent* se sortimentem

52–75

Dílenský stůl *Assistent* se sortimentem

76–79

Nástrojový kufřík

80–81

Sady nářadí

82–84

Nástrojové moduly

85–103



Dílenský vozík HAZET – dobrá práce od společnosti HAZET!



HAZET YouTube
kanál



Assistant[®]

Made in Germany



179N-7

179N X-7

179N XL-7

179N XXL-7

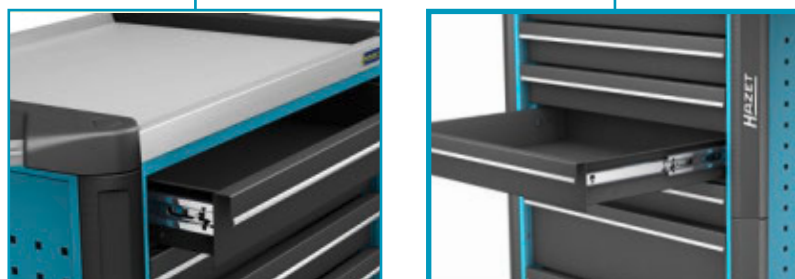
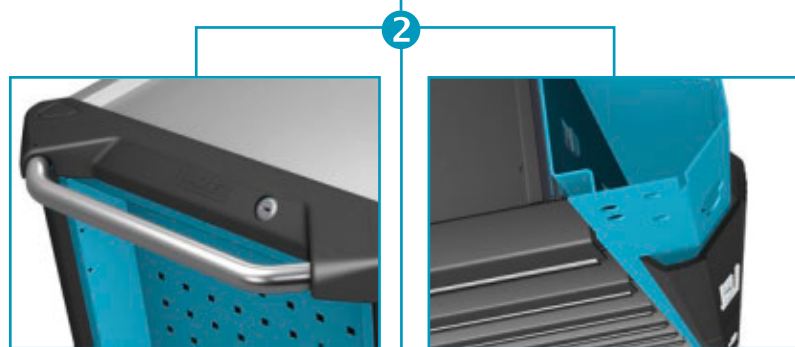
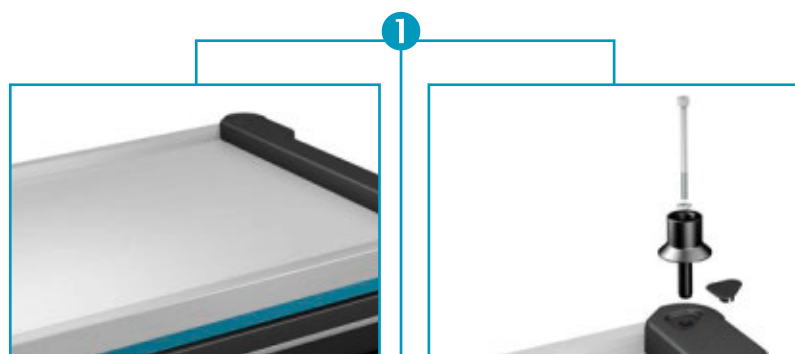

Pracovní plochy, ochrana hran a čela zásuvek

- 179 N s plastem – nebo 179 N X, 179 N XL, 179 N XXL s nerezovou pracovní plochou
- Výrazně zvětšená odkládací a pracovní plocha podle varianty vozíku až o 30%

1 Pracovní plochy

- Kompletně utěsněná, vůči rozpouštědlům odolná plastová resp. nerezová pracovní plocha chrání vnitřek vozíku při rozliti kapalin
- Zvláštní ochrana plastovými koncovými krytkami
- Nerezová pracovní plocha (179 N X, 179 N XL, 179 N XXL)
- V pracovní ploše integrovaná rozhraní pro příslušenství jako držák notebooku a nastavbové moduly

2 Korpus / rukojeť pro pojezd

- Extrémně robustní provedení díky dvoustěnné konstrukci
- Kompletně svařovaná konstrukce celého korpusu pro každodenní tvrdé dílenské nasazení
- Optimalizovaná poddajná ochrana hran na všech čtyřech rozích s opravdovou ochranou proti nárazům díky vnitřnímu konceptu tlumení
- Ergonomicky optimalizovaná rukojeť pro pojezd pro lepší manévrovatelnost
- Rukojeť pro pojezd kovová levá, černá popráškováná u 179 N nebo vůči špině necitlivá rukojeť pro pojezd z kartáčované nerezové oceli u 179 N X a také 179 N XL a 179 N XXL

3 Koncept zajištění

- Ergonomicky umístěná boční poloha zámku pro lepší obsluhu a ochranu klíčů a zámek před poškozením
- Vysoce bezpečně přiléhající uzamykací zařízení s novou centrální technikou zajištění pro optimální ochranu vašeho majetku
- 2stupňové zajištění:
 - Centrální zamykání přes cylindrický zámek s 2 zavíracími klíči
 - Vzájemné zajištění zásuvek pro minimální riziko překlopení

4 Koncept zásuvek

- Samočinné zavírání a vzájemné zajištění zásuvek zabraňuje nechtěnému otevření
- Nosnost na zásuvku
25 kg: 179 N · 179 N X
40 kg: 179 N XL · 179 N XXL
- 100 % vytažení s kuličkově uloženými teleskopickými lištami
- Nový design zásuvek pro optimální využití vnitřního prostoru
- Nová čela zásuvek pro optimalizovanou manipulaci
- Nový, vůči špině necitlivý povrch zásuvek pro snadné čištění
- Velikost zásuvky pro organizační systém 3/3+
- Zásuvka nízká (v 76,5 mm), zásuvka vysoká (v 161 mm)

5 Vysoce výkonný podvozek

- Velká silně zatížitelná kola (Ø 125 mm) s přesným kuličkovým ložiskem a dvojitou kuličkovou klecí ve sklápěcím ložisku, snadný pohyb i při vysoké dynamické zátěži
- 2 řídicí kolečka s dvojitou brzdou: zabrzděné kolečko zabraňuje odvalení, zabrzděné otočné ložisko zabraňuje otočení řídicího kolečka, např. na šikmé ploše
- Ochranný kroužek zabraňuje vniknutí nečistot a vláken
- Hladká elastická kola umožňují tichý chod



Pojízdný pracovní stůl

Assistent® 179 NW



HAZET YouTube
kanál



1

Průchod kabelu na zadní stěně umožňuje např. nabíjení akumulátorových přístrojů při zavřených dveřích

2

Uprostřed umístěný zámek (centrální zamykání a vložka zámku) uzamkne současně dveře a zásuvky. Klíč pro současně zamknutí dveří a zásuvek. (rozsah dodávky: 2 klíče)

3

Optimalizovaná poddajná ochrana hran na všech čtyřech rozích s opravdovou ochranou proti nárazům díky vnitřnímu konceptu tlumení

4

Kompletně svařovaná konstrukce celého korpusu pro každodenní tvrdé dílenské nasazení

5

Dodatečný dřevý rastr pro držák nástrojů, např. HAZET 112-230

6

6 plochých zásuvek, nosnost 25 kg, 76 mm vysoká

7

1 zásuvka pro vysoké zatížení, nosnost: 40 kg, 161 mm vysoká

6 + 7

100 % vytažení zásuvky s kuličkově uloženými teleskopickými lištami – samočinné zavírání. Vzájemné zajištění zásuvek pro minimální riziko překlopení

8

9násobně nastavitelná mezipolice, pevně namontované dveře

9

Pracovní plocha dřevo Multiplex hrušeň, vyměnitelné



Provozní a dílenské zařízení



Příslušenství - dílenské vozíky a pracovní stoly



HAZET No.	Označení	Dílenský vozík <i>Assistant</i> ® typu:										
		166 C	167 T	167-3	167-3 S	177	177 W	178 N	179 N (X)	179 NW	179 N XL	179 N XXL
112/11	Držák nářadí		×	×	×	×	×	×	×	×	×	×
161 T-178 N/4	Sada oddělovacích plechů							×				
161 T-179 N XL/5	Sada oddělovacích plechů										×	
161 T-179 N XL/5 H	Sada oddělovacích plechů										×	
161 T-179 N XXL/6	Sada oddělovacích plechů											×
161 T-179 N XXL/6 H	Sada oddělovacích plechů											×
161 T-179 N/4	Sada oddělovacích plechů							×	×			
161 T-179 N/4 H	Sada oddělovacích plechů							×	×			
161 T-347 x 120/5	Oddělovací plechy					×	×					
161 T-347 x 60/5	Oddělovací plechy					×	×					
161 T-395 x 120/5	Oddělovací plechy							×	×	×	×	
161 T-395 x 60/5	Oddělovací plechy							×	×	×	×	
161-1	Protiskluzová podložka					×	×	×				
161-9	Vakuový manipulátor	×										
162 C-5	Vana na drobné součástky	×	×									
162 C-6/5	Oddělovací plechy pro mezipolici	×										
167 T 23	Odkládací dno		×									
167 T 26	Děrovaná stěna		×									
173-38	Protiskluzová podložka										×	
177 W-21	Dveře						×					
179 N W-11	Přípevňovací sada svěráku						×			×		
179 N W-22	Regálová zásuvka									×		
179 N W-23	Regálová police									×		
179 N W-26	Svislá děrovaná tabule na nářadí									×		
179 N XL-26	Svislá děrovaná tabule na nářadí										×	
179 N XXL-26	Svislá děrovaná tabule na nářadí											×
179 N-19	Sběrač malých dílů							×	×	×	×	
179 N-21	Boční dveře							×		×	×	
179 N-26	Svislá děrovaná tabule na nářadí							×				
179 N-33	Koš na papír				×	×	×	×	×	×	×	×
179 N-35	Držák dóz		×		×		×	×	×		×	×
179 N-40	Základní držák							×		×	×	
179 N-42	Držák notebooku · kompletní							×		×	×	
179 N-45	Držák tabletu			×	×	×		×	×		×	×
179 W-40	Základní držák						×			×		
179 W-42	Držák notebooku						×			×		
179-35	Držák dóz		×	×		×	×	×	×	×	×	×
180-24	Držák dokumentů		×		×	×	×	×	×	×	×	×
180-34	Držák papírové role				×	×	×	×			×	×
180-35	Držák dóz		×		×					×		
2175 N	Paralelní svěrák					×	×			×		
2175 N-11	Podložka					×						

1) Používá se v páru

2) Respektujte pokyny pro používání

3) Ve spojení s 179 N W-11

4) Ve spojení s 179 T-26



Moduly

Správné vložení pro každou zásuvku

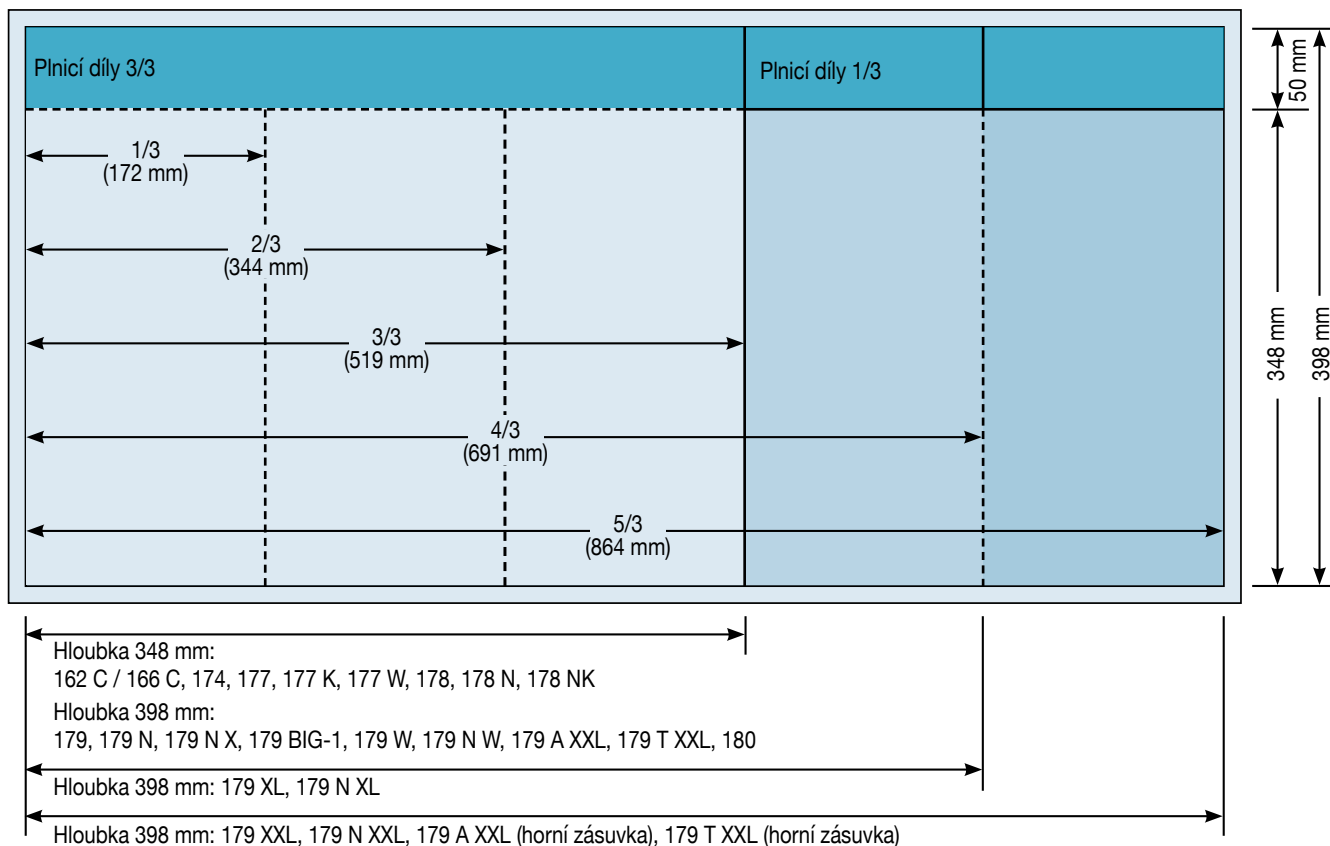

1/9

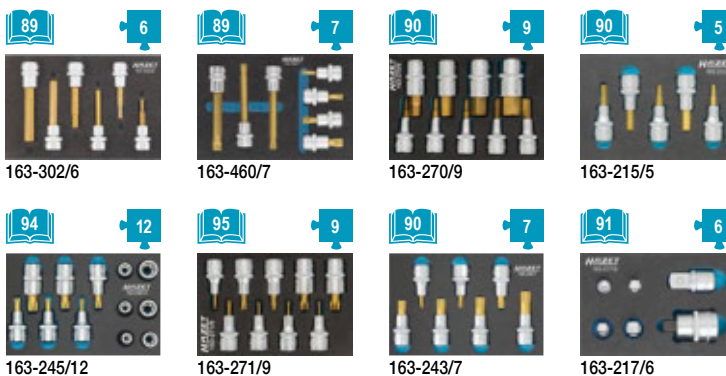
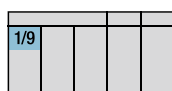

Plnicí díly 3/3

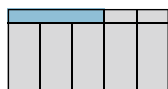

Plnicí díly 1/3

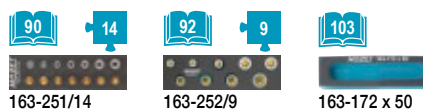
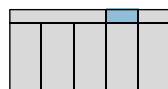



Provozní a dílenské zařízení



1/3

1/3			
-----	--	--	--



163-95/8



163-292/8



163-428/15



163-97/6

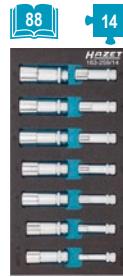

163-259/14



163-483/33



163-272/32



163-191/18



163-459/15



163-463/15



163-220/13



163-468/8



163-184/6

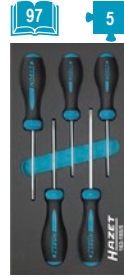

163-185/5



163-266/6



163-264/5



163-461/5



163-122/3



163-182/9



163-96/3



163-124/4



163-121/4



163-425/3



163-464/3



163-426/4



163-580/18



163-229/7



163-226/4



163-227/3



163-548/14



163-130 L

1/3+

1/3+			
------	--	--	--



163-519/12



163-509/12



163-515/16



163-520/15



163-518/9



163-379/38



163-570/24



163-571/22



163-522/6

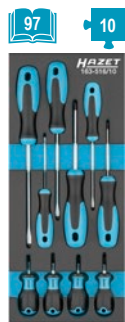

163-516/10



163-380/4



163-517/15



163-382/3



163-375/5



163-511/4



163-510/8



163-523/11



2/3

2/3			
-----	--	--	--

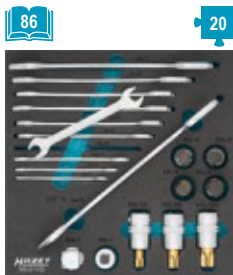

163-211/20

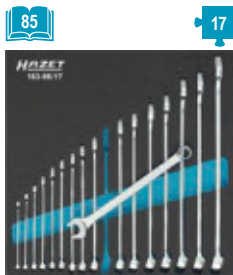

163-98/17



163-99/18

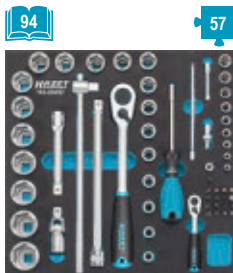

163-224/57

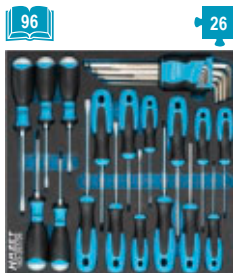

163-297/26

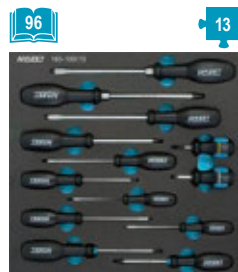

163-100/13

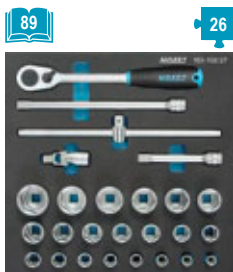

163-102/27

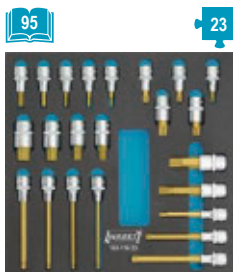

163-119/23

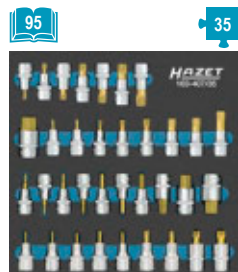

163-407/35



163-424/9

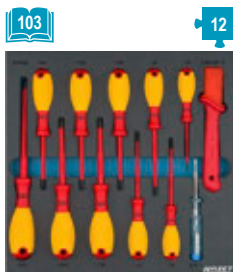

163-546/12

2/3+

2/3+			
------	--	--	--

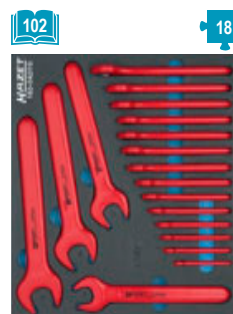

163-542/18

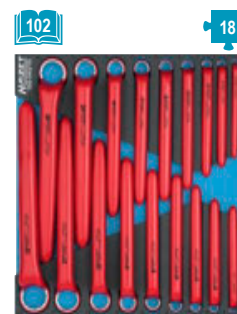

163-543/18

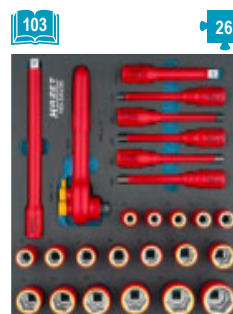

163-544/26

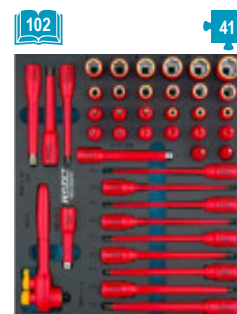

163-545/41

3/3

3/3			
-----	--	--	--



163-210/19



163-30/25



163-366/18

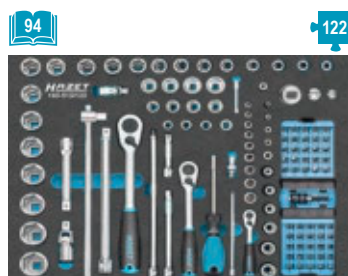

163-513/122

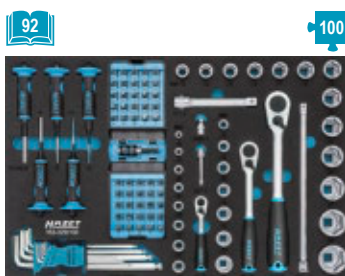

163-329/100

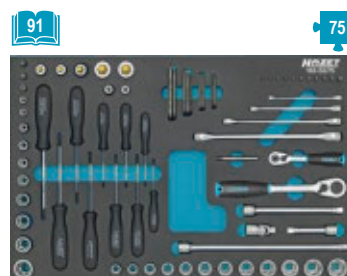

163-53/75



Provozní a dílenské zařízení



3/3 (pokračování)

3/3		
-----	--	--

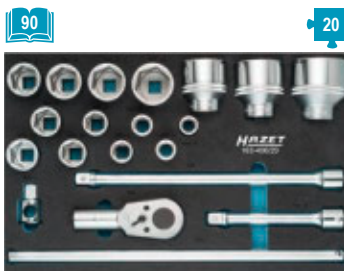

163-406/20



163-120/24



163-330/16



163-60/22

3/3+

3/3+		
------	--	--



163-374/27



163-140/33

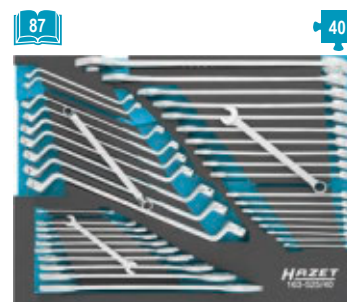

163-525/40



163-371/7



163-138/77

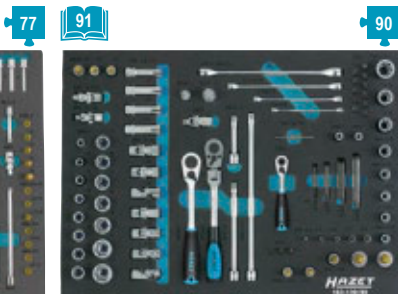

163-139/90

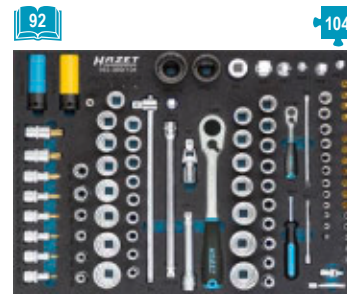

163-369/104



163-141/31



163-526/41

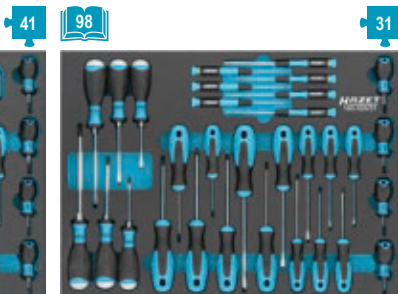

163-524/31

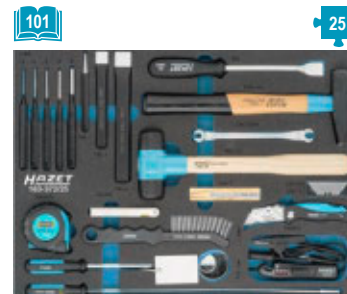

163-372/25



163-143/18



4/3+

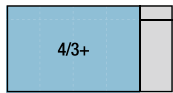

87



163-478/40

40

87

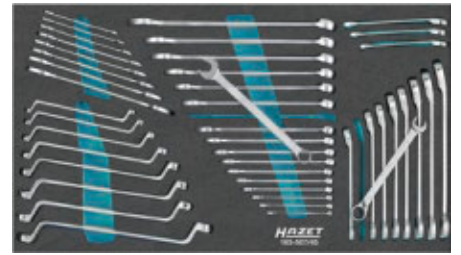

163-507/45

45

88



163-528/56

56

93



163-508/138

138

93



163-481/194

194

93

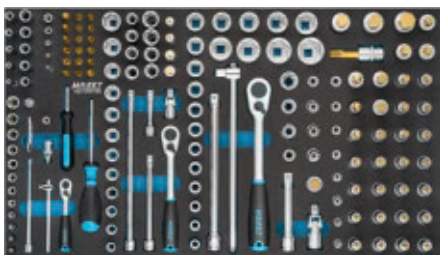

163-549/160

160

98

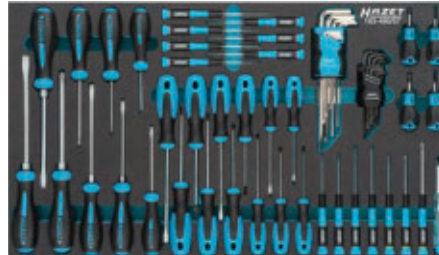

163-480/57

57

97



163-527/56

56

100



163-479/26

26



Dílenské vozíky HAZET

Made in Germany

HAZET No.	Technické údaje					Provedení			
	$d \times \check{s} \times v$ mm	Celková nosnost (statická) kg	Nosnost na zásuvku kg	Výsuv zásuvky %	Velikost modulu	Ochranný díl	Pracovní deska	Uzávěr zásuvky	
177-6 -7	780x498x915	300	20	100%			Plast, odolný vůči rozpouš- tědlům	Centrální zamykání samostatná aretace pro každou zásuvku	33
178 N-7	781x498x1037	480	20	100%			Plast, odolný vůči rozpouš- tědlům	Centrální zamykání samostatná aretace pro každou zásuvku	35
178 N K-3	696x488x390	145	20	100%				Centrální zamykání samostatná aretace pro každou zásuvku	35
179 N-6 ... -9	785x518x1020	540	25	100%		Svislá, průběžná ochrana hran na všech čtyřech rozích vozíku	Plast, odolný vůči rozpouš- tědlům	Samočinné zavírání centrální zamykání vzájemné blokování výsuvu	37
179 N X-6 ... -8	786x518x1020	540	25	100%		Svislá, průběžná ochrana hran na všech čtyřech rozích vozíku	Nerezová ocel	Samočinné zavírání centrální zamykání vzájemné blokování výsuvu	37
179 N XL-6 ... -8	959x518x1020	1000	40	100%		Svislá, průběžná ochrana hran na všech čtyřech rozích vozíku	Nerezová ocel	Samočinné zavírání centrální zamykání vzájemné blokování výsuvu	39
179 N XXL-7 ... -8	1133x518x1020	1000	40	100%		Svislá, průběžná ochrana hran na všech čtyřech rozích vozíku	Nerezová ocel	Samočinné zavírání centrální zamykání vzájemné blokování výsuvu	40



HAZET No.	Technické údaje					Provedení			
	$d \times š \times v$ mm	Celková nosnost (statická) kg	Nosnost na zásuvku kg	Výsuv zásuvky %	Velikost modulu	Ochranný díl	Pracovní deska	Uzávěr zásuvky	
166 N 	680x350x965	300				Plastové profily pro ochranu proti nárazu	PVC rohožka	Visací zámek	41
166 C 	725x398x1102	300				Plastové profily pro ochranu proti nárazu	Dřevo Multiplex buk	Visací zámek	41
167-3 	890x542x899	150			 2x				42
167-3 S 	888x541x899	150			 2x				42
167 T 	773x740x1345	150							43
177 W-6 -7 	1040x520x934	750	20	100%			Dřevo Multiplex bříza	Centrální zamykání samostatná aretace pro každou zásuvku	44
179 N W-7 	1150x600x965	750	25 / 40	100%		Svislá, průběžná ochrana hran na všech čtyřech rozích vozíku	Dřevo Multiplex bříza	Centrální zamykání Samostatná aretace pro každou zásuvku Vzájemné blokování výsuvu	45



Provozní a dílenské zařízení

Dílenský vozík *Assistant*[®]



Dílenský vozík *Assistant*[®]

177 Dílenský vozík *Assistant*[®]

Made in Germany

• Vozíky na nářadí, na materiál a montážní vozíky



- Velká ložiskově uložená kola (Ø 100 mm), snadný pohyb i při vysokém dynamickém zatížení
- 2 říditelná kolečka (Ø 100 mm), 1 x s aretací
- Ochrana proti vniknutí vláken – chrání ložiska před nečistotami a vlákny
- Šedá hladká elastická kola umožňují tichý chod
- Dvoustupňový koncept zajištění:
 - Centrální zamykání přes cylindrický zámek s 2 klíči
 - Jednotlivé západky zabraňují nechtěnému otevření
 - 100% výsuv s válečkovým vedením
- Celková nosnost (dynamická): 300 kg
- Celková nosnost (statická): 300 kg
- Pracovní deska: plast, odolný vůči rozpouštědlům, s integrovanými odkládacími příhrádkami
- Nosnost na zásuvku: 20 kg
- Barva: Modrá HAZET



Následující příslušenství je k dostání zvlášť:

HAZET No.	Označení		HAZET No.	Označení	
112/11	Držák nářadí	47	180-24	Držák dokumentů	51
161-1	Protiskluzová podložka	48	179 N-33	Koš na papír	50
161 T-347 x 120/5	Oddělovací plechy	48	180-34	Držák papírové role	51
161 T-347 x 60/5	Oddělovací plechy	48	2175 N	Paralelní svěrák	51
179-35	Držák dóz	50	2175 N-11	Podložka	51

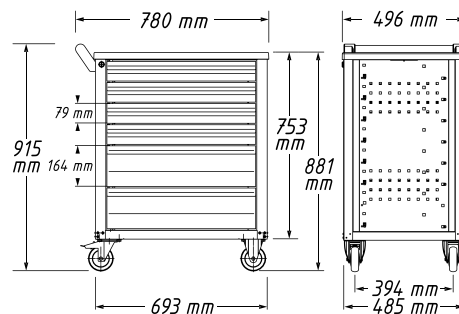
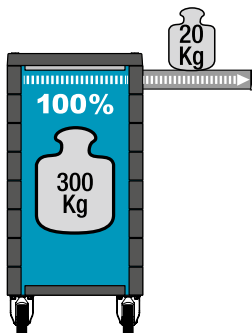
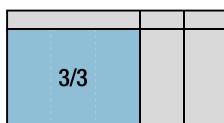
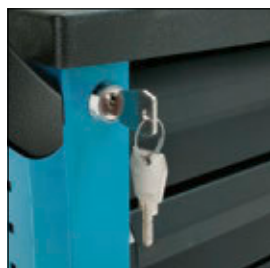

HAZET No.	$d \times \check{s} \times v$ mm	79 x 527 x 348 mm	164 x 527 x 348 mm		kg	EAN-No. 4000896+	€
• 4 nízké a 2 vysoké zásuvky							
177-6	780x498x915	4x	2x	6x	62,8	148578	733,-
• 6 nízkých zásuvek a 1 vysoká zásuvka							
177-7	780x498x915	6x	1x	7x	64,8	148592	773,-



178 N Dílenský vozík *Assistant*

Made in Germany

• Vozíky na nářadí, na materiál a montážní vozíky

- Velká kola uložena v kuličkových ložiscích (125 mm), snadný pohyb i při vysokém dynamickém zatížení
- 2 říditelná kolečka s dvojitým zastavením: zabrzděná kolečka brání odjetí, zabrzděná otočná ložiska brání otáčení říditelných koleček, např. na šikmých plochách
- Ochranný kroužek zabraňuje vniknutí nečistot a vláken
- Elastická kola umožňují tichý chod
- Dvoustupňový koncept zajištění:
 - Centrální zamykání, uzamykatelné přes cylindrický zámek s 2 zavracími klíči
 - Jednotlivé západky zabraňují nechtěnému otevření
 - 100 % výsuv s válečkovým vedením
- Celková nosnost (dynamická): 480 kg
- Celková nosnost (statická): 480 kg
- Pracovní deska: plast, odolný vůči rozpouštědlům, s integrovanými odkládacími příhrádkami
- Nosnost na zásuvku: 20 kg
- Barva: Modrá HAZET



Následující příslušenství je k dostání zvlášť:

HAZET No.	Označení		HAZET No.	Označení	
112/11	Držák nářadí	47	179 N-33	Koš na papír	50
161-1	Protiskluzová podložka	48	180-24	Držák dokumentů	51
161 T-178 N/4	Sada oddělovacích plechů	49	180-34	Držák papírové role	51
179-35	Držák dóz	50			

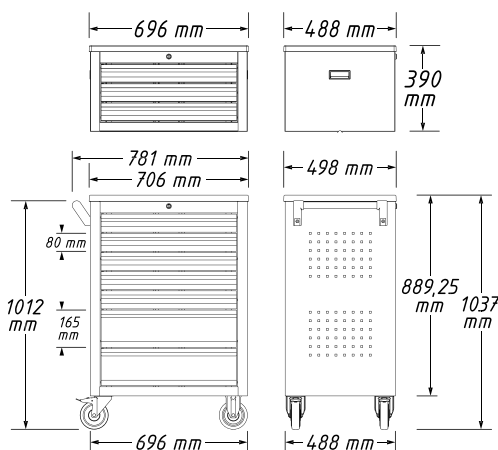
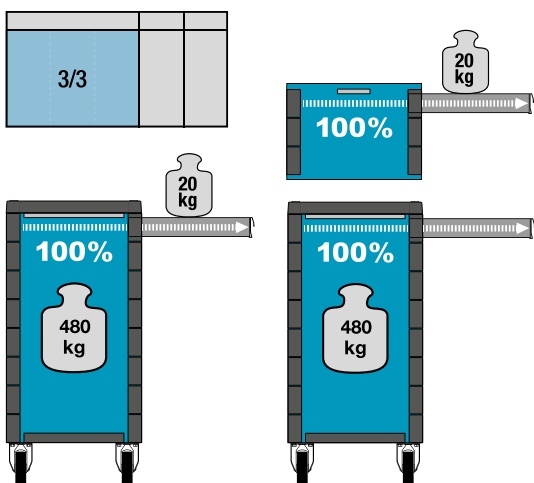

YouTube Clip





Provozní a dílenské zařízení

Dílenský vozík *Assistent*[®]



178 N Dílenský vozík *Assistent*[®]



HAZET No.	d x š x v mm	80 x 527 x 348 mm	165 x 527 x 348 mm	kg	EAN-No. 4000896+	€
Dílenský vozík 178 N-7						
<ul style="list-style-type: none"> • 5 nízkých a 2 vysoké zásuvky • Stabilní madlo pevně přimontované k tělu • Pracovní plocha: plast, odolný proti rozpouštědlům, s integrovanými odkládacími přihrádkami • Lemování pracovní plochy chrání díly před pádem • Individuální možnosti upevnění přes obdélníkový děrový rastr na bočních stěnách, např. s programem háků HAZET skupiny výrobků 112 pro nářadí nebo jiné konstrukční díly, jako je např. držák dóz, držák papírové role, koš na papír atd. 						
178 N-7	781x498x1037	5x	2x	74,1	202782	872,-
178 N-10 sestávající z dílenského vozíku 178 N-7, nastavbového kufru 178 N K-3						
Dílenský vozík 178 N-7:						
<ul style="list-style-type: none"> • 5 nízkých a 2 vysoké zásuvky • Stabilní madlo pevně přimontované k tělu • Pracovní plocha: plast, odolný proti rozpouštědlům, s integrovanými odkládacími přihrádkami • Lemování pracovní plochy chrání díly před pádem • Individuální možnosti upevnění přes obdélníkový děrový rastr na bočních stěnách, např. s programem háků HAZET skupiny výrobků 112 pro nářadí nebo jiné konstrukční díly, jako je např. držák dóz, držák papírové role, koš na papír atd. 						
Nastavbový kufr 178 N K-3:						
<ul style="list-style-type: none"> • Pro dílenský vozík Assistent 178 N • 3 nízké zásuvky • 2 držadla integrovaná v korpusu • Volitelně: pracovní deska z plastu, odolná vůči rozpouštědlům, s integrovanými odkládacími přihrádkami, HAZET č. 177-05 						
178 N-10	781x498x1410	8x	2x	107,8	202805	1326,-
Nastavbový kufr 178 N K-3						
<ul style="list-style-type: none"> • Pro dílenský vozík Assistent 178 N • 3 nízké zásuvky • 2 držadla integrovaná v korpusu • Volitelně: pracovní deska z plastu, odolná vůči rozpouštědlům, s integrovanými odkládacími přihrádkami, HAZET č. 177-05 						
178 N K-3	696x488x390	3x	-	33,7	202799	519,-

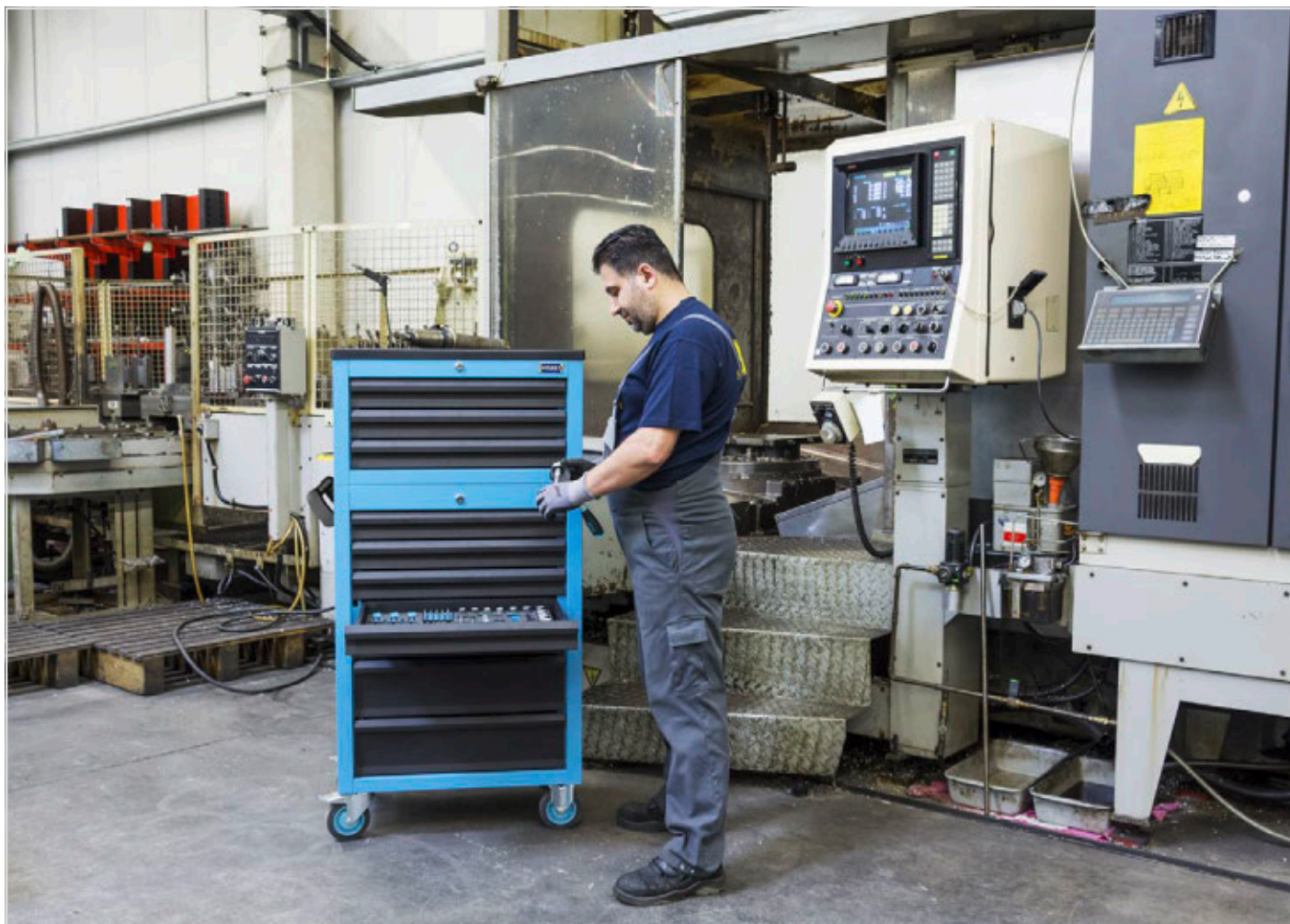



179 N Dílenský vozík *Assistant*[®]

Made in Germany

• Vozíky na nářadí, na materiál a montážní vozíky

Pracovní plochy

- Výrazně zvětšená odkládací a pracovní plocha v plastu (179 N) příp. nerez (179 NX)
- Kompletně utěsněná pracovní plocha chrání vnitřek vozíku při rozliti kapalin
- V pracovní ploše integrovaná rozhraní pro příslušenství jako držák notebooku a nastavbové moduly

Korpus / rukojeť pro pojezd

- Extrémně robustní provedení díky dvoustěnné konstrukci
- Kompletně svařovaná konstrukce celého korpusu pro každodenní tvrdé dílenské nasazení
- Optimalizovaná poddajná ochrana hran na všech čtyřech rozích s opravdovou ochranou proti nárazům díky vnitřnímu konceptu tlumení
- Ergonomicky optimalizovaná rukojeť pro pojezd pro lepší manévrovatelnost

Koncept zajištění

- Ergonomicky umístěná boční poloha zámku pro lepší obsluhovatelnost chrání klíč a zámek před poškozením
- Vysoce bezpečně přiléhající uzamykací zařízení s centrální technikou zajištění pro optimální ochranu Vašeho majetku
- 2stupňové zajištění
 - Centrální zamykání, uzamykatelné přes cylindrický zámek s 2 zavíracími klíči
 - Vzájemné zajištění zásuvek pro minimální riziko překlopení

Koncept zásuvek

- Samočinné zavírání a vzájemné zajištění zásuvek zabraňuje nechtěnému otevření
- 100 % vytažení s kuličkově uloženými teleskopickými lištami
- Design zásuvek pro optimální využití vnitřního prostoru
- Čela zásuvek pro optimalizovanou manipulaci
- Povrch zásuvek necitlivý vůči špíně pro snadné čištění

Vysoce výkonný podvozek

- Velká, silně zatížitelná kola s přesným kuličkovým ložiskem a dvojitou kuličkovou klecí ve sklápěcím ložisku – snadný pohyb i při vysoké dynamické zátěži
- 2 řídicí kolečka s dvojitou brzdou: zabrzdnuté kolečko zabraňuje odvalení, zabrzdnuté otočné ložisko zabraňuje otočení řídicího kolečka, např. na šikmé ploše
- Ochranný kroužek zabraňuje vniknutí nečistot a vláken
- Elastická kola umožňují tichý chod

Assistant[®] 179 N-6 – 9:

- Plastová pracovní plocha odolná vůči rozpouštědlům
- Rukojeť pro pojezd kovová, černá poprášková

Assistant[®] 179 N X-6 – 8:

- Nerezová pracovní plocha
- Zvláštní ochrana plastovými koncovými krytkami
- Nerezová rukojeť pro pojezd kartáčovaná
- Celková nosnost (dynamická): 540 kg
- Celková nosnost (statická): 1000 kg
- Nosnost na zásuvku: 25 kg
- Barva: Modrá HAZET

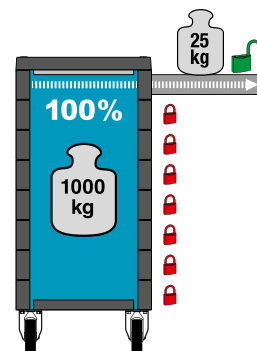
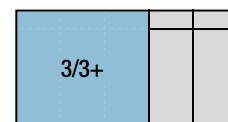

YouTube Clip

Následující příslušenství je k dostání zvlášť:

HAZET No.	Označení	
112/11	Držák nářadí	47
161 T-179 N/4	Sada oddělovacích plechů	49
161 T-179 N/4 H	Sada oddělovacích plechů	49
161 T-395x120/5	Oddělovací plechy	48
161 T-395x60/5	Oddělovací plechy	48
179-35	Držák dóz	50
179 N-19	Sběrač malých dílů	50
179 N-21	Boční dveře	50

HAZET No.	Označení	
179 N-26	Svislá dřevěná tabule na nářadí	50
179 N-33	Koš na papír	50
179 N-40	Základní držák	50
179 N-42	Držák notebooku - kompletní	50
180-24	Držák dokumentů	51
180-34	Držák papírové role	51
180-35	Držák dóz	51

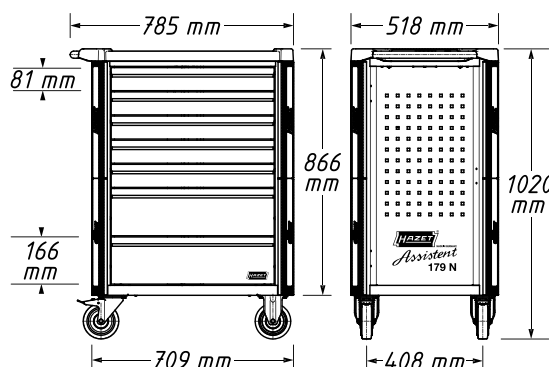



Provozní a dílenské zařízení

Dílenský vozík *Assistent*[®]



179 N Dílenský vozík *Assistent*[®]

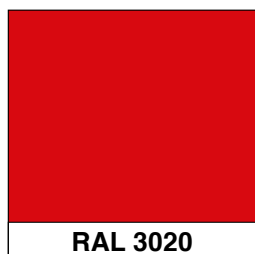

RAL 3020



RAL 9005

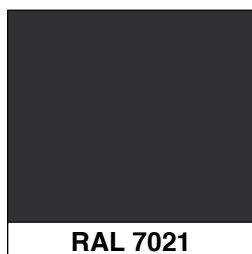

RAL 7021



179 N

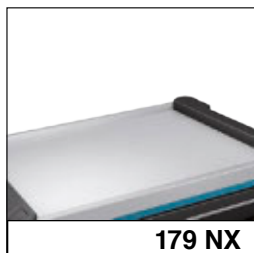

179 NX

HAZET No.	d x š x v mm	81 x 522 x 398 mm	166 x 522 x 398 mm	kg	EAN-No. 4000896+	€
• 3 nízké a 3 vysoké zásuvky 179 N-6	785x518x1020	3x	3x	90	214570	1240,-
• 5 nízkých a 2 vysoké zásuvky 179 N-7	785x518x1020	5x	2x	90	214488	1273,-
• 5 nízkých a 2 vysoké zásuvky • Barva RAL 3020 (červená) 179 N-7-RAL 3020	785x518x1020	5x	2x	90	220212	1273,-
• 5 nízkých a 2 vysoké zásuvky • Barva RAL 9005 (matně černá) 179 N-7-RAL 9005	785x518x1020	5x	2x	90	220229	1273,-
• 7 nízkých zásuvek a 1 vysoká zásuvka 179 N-8	785x518x1020	7x	1x	90	214587	1370,-
• 7 nízkých zásuvek a 1 vysoká zásuvka • Barva RAL 7021 (černošedá) 179 N-8-RAL 7021	785x518x1020	7x	1x	90	220311	1370,-
• 9 nízkých zásuvek 179 N-9	785x518x1020	9x	-	90	220236	1403,-
• 3 nízké a 3 vysoké zásuvky 179 N X-6	786x518x1020	3x	3x	90	215560	1314,-
• 5 nízkých a 2 vysoké zásuvky 179 N X-7	786x518x1020	5x	2x	90	215577	1333,-
• 5 nízkých a 2 vysoké zásuvky • Barva RAL 3020 (červená) 179 N X-7-RAL 3020	786x518x1020	5x	2x	90	219322	1333,-
• 7 nízkých zásuvek a 1 vysoká zásuvka 179 N X-8	786x518x1020	7x	1x	90	215584	1445,-



179 NXL Dílenský vozík *Assistent*[®]

Made in Germany

• Vozíky na nářadí, na materiál a montážní vozíky

Pracovní plochy

- Výrazně zvětšená odkládací a pracovní plocha v nerez
- Kompletně utěsněná pracovní plocha chrání vnitřek vozíku při rozlité kapalin
- V pracovní ploše integrovaná rozhraní pro příslušenství jako držák notebooku a nastavbové moduly
- Nerezová pracovní plocha
- Zvláštní ochrana plastovými koncovými krytkami

Korpus / rukojeť pro pojezd

- Extrémně robustní provedení díky dvoustěnné konstrukci
- Kompletně svařovaná konstrukce celého korpusu pro každodenní tvrdé dílenské nasazení
- Optimalizovaná poddajná ochrana hran na všech čtyřech rozích s opravdovou ochranou proti nárazům díky vnitřnímu konceptu tlumení
- Ergonomicky optimalizovaná rukojeť pro pojezd pro lepší manévrovatelnost
- Nerezová rukojeť pro pojezd kartáčovaná

Koncept zajištění

- Ergonomicky umístěná boční poloha zámku pro lepší obsluhovatelnost chrání klíč a zámek před poškozeními
- Vysoce bezpečně přiléhající uzamykací zařízení s centrální technikou zajištění pro optimální ochranu Vašeho majetku
- 2stupňové zajištění
 - Centrální zamykání, uzamykatelné přes cylindrický zámek s 2 zavíracími klíči
 - Vzájemné zajištění zásuvek pro minimální riziko překlopení

Koncept zásuvek

- Samočinné zavírání a vzájemné zajištění zásuvek zabraňuje nechtěnému otevření
- 100 % vytažení s kuličkově uloženými teleskopickými lištami
- Design zásuvek pro optimální využití vnitřního prostoru
- Čela zásuvek pro optimalizovanou manipulaci
- Povrch zásuvek necitlivý vůči špíně pro snadné čištění

Vysoce výkonný podvozek

- Velká, silně zatížitelná kola s přesným kuličkovým ložiskem a dvojitou kuličkovou klecí ve sklápěcím ložisku – snadný pohyb i při vysoké dynamické zátěži
- 2 řídicí kolečka s dvojitou brzdou: zabrzděné kolečko zabraňuje odvalení, zabrzděné otočné ložisko zabraňuje otočení řídicího kolečka, např. na šikmé ploše
- Ochranný kroužek zabraňuje vniknutí nečistot a vláken
- Elastická kola umožňují tichý chod
- Celková nosnost (dynamická): 750 kg
- Celková nosnost (statická): 1000 kg
- Nosnost na zásuvku: 40 kg
- Barva: Modrá HAZET



Ⓔ

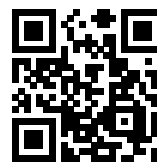
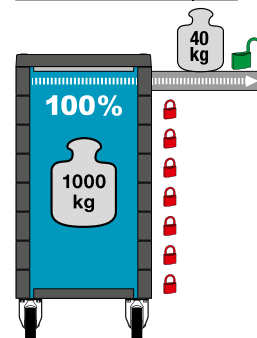
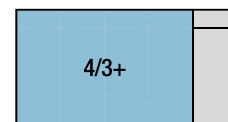

YouTube Clip

Následující příslušenství je k dostání zvlášť:

HAZET No.	Označení		HAZET No.	Označení	
112/11	Držák nářadí	47	179 N-21	Boční dveře	50
161 T-179 N XL/5	Sada oddělovacích plechů	49	179 N-33	Koš na papír	50
161 T-179 N XL/5 H	Sada oddělovacích plechů	49	179 N-40	Základní držák	50
161 T-395x120/5	Oddělovací plechy	48	179 N-42	Držák notebooku - kompletní	50
161 T-395x60/5	Oddělovací plechy	48	179 N XL-26	Svislá děrovaná tabule na nářadí	51
173-38	Protiskluzová podložka	48	180-24	Držák dokumentů	51
179-35	Držák dóz	50	180-34	Držák papírové role	51
179 N-19	Sběrač malých dílů	50			

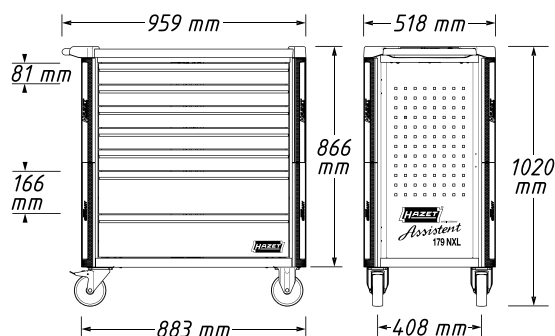



Provozní a dílenské zařízení

Dílenský vozík *Assistent*[®]



179 NXL Dílenský vozík *Assistent*[®]

Ⓔ

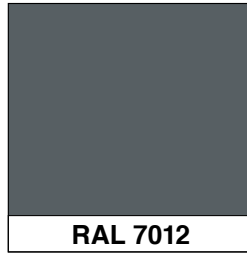
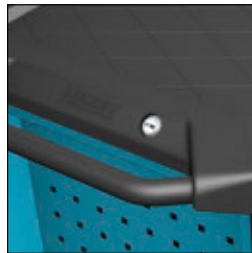

RAL 7012

HAZET No.	d x š x v mm	81 x 696 x 398 mm	166 x 696 x 398 mm	kg	EAN-No. 4000896+	€
• 3 nízké a 3 vysoké zásuvky 179 N XL-6	959x518x1020	3x	3x	125	215171	1980,-
• 5 nízkých a 2 vysoké zásuvky 179 N XL-7	959x518x1020	5x	2x	125	215164	2076,-
• 7 nízkých zásuvek a 1 vysoká zásuvka 179 N XL-8	959x518x1020	7x	1x	125	215218	2172,-
• 7 nízkých zásuvek a 1 vysoká zásuvka • Barva RAL 7012 (šed' bazaltová) 179 N XL-8-VW	959x518x1020	7x	1x	125	220243	2172,-

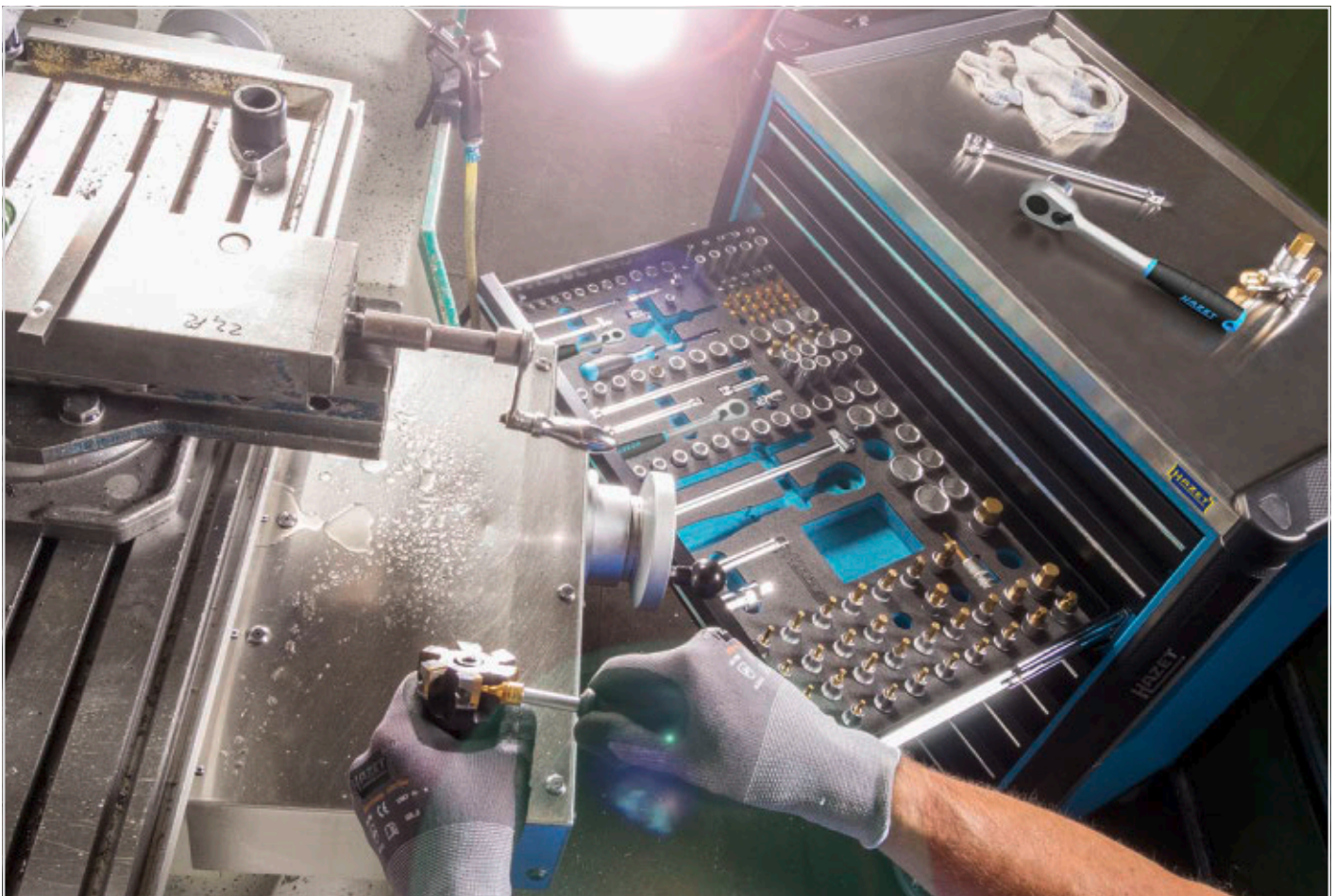



179 NXXL Dílenský vozík *Assistant*

Made in Germany

• Vozíky na nářadí, na materiál a montážní vozíky

Pracovní plochy

- Výrazně zvětšená odkládací a pracovní plocha v nerez
- Kompletně utěsněná pracovní plocha chrání vnitřek vozíku při rozlítí kapalin
- V pracovní ploše integrovaná rozhraní pro příslušenství jako držák notebooku a nástavbové moduly
- Nerezová pracovní plocha
- Zvláštní ochrana plastovými koncovými krytkami

Korpus / rukojeť pro pojezd

- Extrémně robustní provedení díky dvoustěnné konstrukci
- Kompletně svařovaná konstrukce celého korpusu pro každodenní tvrdé dílenské nasazení
- Optimalizovaná poddajná ochrana hran na všech čtyřech rozích s opravdovou ochranou proti nárazům díky vnitřnímu konceptu tlumení
- Ergonomicky optimalizovaná rukojeť pro pojezd pro lepší manévrovatelnost
- Nerezová rukojeť pro pojezd kartáčovaná

Koncept zajištění

- Ergonomicky umístěná boční poloha zámku pro lepší obsluhovatelnost chrání klíč a zámek před poškozením
- Výsoce bezpečně přiléhající uzamykací zařízení s centrální technikou zajištění pro optimální ochranu Vašeho majetku
- 2stupňové zajištění
 - Centrální zamykání, uzamykatelné přes cylindrický zámek s 2 zavracími klíči
 - Vzájemné zajištění zásuvek pro minimální riziko překlopení

Koncept zásuvek

- Samočinné zavírání a vzájemné zajištění zásuvek zabraňuje nechtěnému otevření
- 100 % vytažení s kuličkově uloženými teleskopickými lištami
- Design zásuvek pro optimální využití vnitřního prostoru
- Čela zásuvek pro optimalizovanou manipulaci
- Povrch zásuvek necitlivý vůči špíně pro snadné čištění

Výsoce výkonný podvozek

- Velká, silně zatížitelná kola s přesným kuličkovým ložiskem a dvojitou kuličkovou klecí ve sklápěcím ložisku – snadný pohyb i při vysoké dynamické zátěži
- 2 řídicí kolečka s dvojitou brzdou: zabrzděné kolečko zabraňuje odvalení, zabrzděné otočné ložisko zabraňuje otočení řídicího kolečka, např. na šikmé ploše
- Ochranný kroužek zabraňuje vniknutí nečistot a vláken
- Elastická kola umožňují tichý chod
- Celková nosnost (dynamická): 750 kg
- Celková nosnost (statická): 1000 kg
- Nosnost na zásuvku: 40 kg
- Barva: Modrá HAZET



(E)

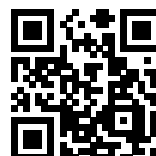

YouTube Clip

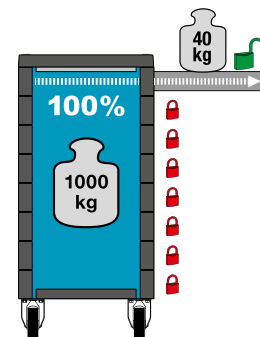
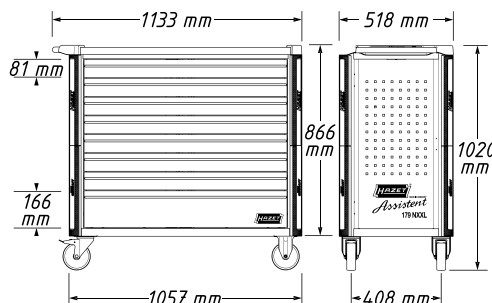
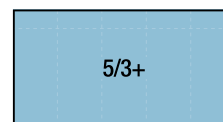

Následující příslušenství je k dostání zvlášť:

HAZET No.	Označení		HAZET No.	Označení	
112/11	Držák nářadí	47	179 N-33	Koš na papír	50
161 T-179 N XXL/6	Sada oddělovacích plechů	49	179 N-40	Základní držák	50
161 T-179 N XXL/6 H	Sada oddělovacích plechů	49	179 N-42	Držák notebooku - kompletní	50
161 T-395x120/5	Oddělovací plechy	48	179 N XXL-26	Svislá děrovaná tabule na nářadí	51
161 T-395x60/5	Oddělovací plechy	48	180-24	Držák dokumentů	51
179-35	Držák dóz	50	180-34	Držák papírové role	51
179 N-19	Sběrač malých dílů	50	180-35	Držák dóz	51
179 N-21	Boční dveře	50			



HAZET No.	d x š x v mm	81 x 870 x 398 mm	166 x 870 x 398 mm	kg	EAN-No. 4000896+	€
• 5 nízkých a 2 vysoké zásuvky						
179 N XXL-7	1133x518x1020	5x	2x	145	214624	2553,-
• 7 nízkých zásuvek a 1 vysoká zásuvka						
179 N XXL-8	1133x518x1020	7x	1x	145	214778	2698,-



Provozní a dílenské zařízení

Dílenský vozík *Assistent*



166 N Dílenský vozík *Assistent*

Made in Germany

• Vozíky na nářadí, na materiál a montážní vozíky



Originál

- Prostorově úsporné řešení
- Sloupky otočné na nejnižší výšku (500 mm) pro skladnou přepravu. Sklopené sloupky lze použít jako držadla.
- Uzamykatelné visacím zámekem (včetně 2 klíčů)
- Vnější pryžové profily chrání desku stolu a prostřední skříňky před poškozením
- Deska stolu s pryžovou podložkou, 2 prostřední skříňky včetně 4 variabilních rozvržení, prostorné dno
- 4 celopryžová kolečka s ochranou proti vniknutí vláken, dvojité kuličkové ložisko, z toho 2 říditelná kolečka s brzdou
- Celková nosnost (dynamická): 150 kg
- Celková nosnost (statická): 300 kg
- Pracovní deska: PVC rohožka
- Barva: Modrá HAZET

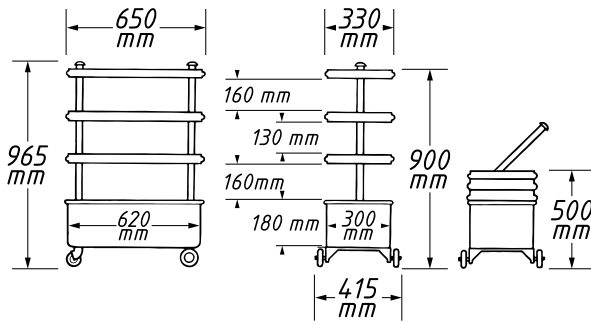

166 C Dílenský vozík *Assistent*

Made in Germany

• Vozíky na nářadí, na materiál a montážní vozíky



- Střední skříň vhodná pro uložení nářadí HAZET, včetně 2 oddělovacích plechů
- Přídavný posuvný panel, integrovaný ve střední skřínce, např. pro posuvné měřítko a malé díly
- Prostorný spodní box z ocelového plechu
- Velká kola s lepšími provozními vlastnostmi při jízdě po hrbolech
- Spouštěcí, uzamykatelný, včetně visacího zámku se 2 klíči
- Obvodový pryžový profil
- Celková nosnost (statická): 300 kg
- Pracovní deska: Dřevo Multiplex buk, vyměnitelné
- Barva: Modrá HAZET
- Sloupky otočné na nejnižší výšku (647 mm) pro skladnou přepravu

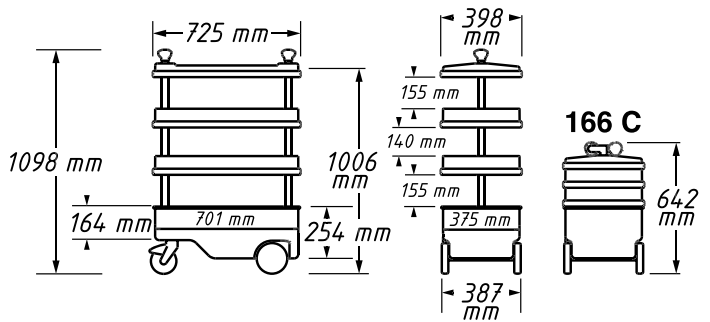
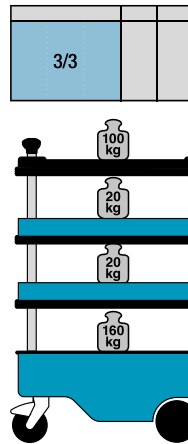
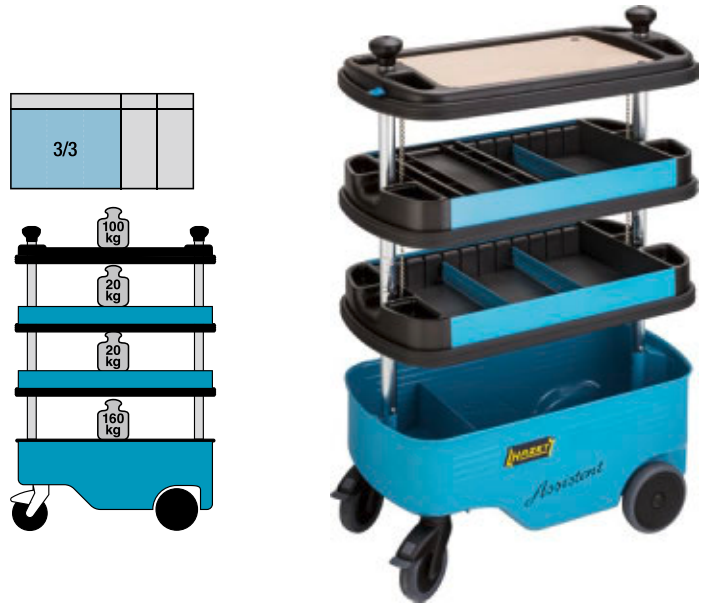

Následující příslušenství je k dostání zvlášť:

HAZET No.	Označení		HAZET No.	Označení	
161-9	Přísavný držák	48	162 C-6/5	Oddělovací plechy pro mezipolici	49
162 C-5	Vana na drobné součásti	49			

HAZET No.	d x š x v mm	kg	EAN-No. 4000896+	€
166 N	650x415x965	24,5	004959	874,-

HAZET No.	d x š x v mm	kg	EAN-No. 4000896+	€
166 C	725x398x1102	27,6	072286	919,-



167-3 Servisní vozík *Assistant*[®]

Made in Germany

• Flexibilní a stabilní pro všechny účely



- 15násobně výškově nastavitelný (prostřední police)
- Další police a protiskluzové rohože (2x 180-38) k dostání jako volitelné příslušenství
- Stabilní konstrukce z ocelového plechu, nosnost každé police: 50 kg
- Velká kola uložená v kuličkových ložiscích (Ø 100 mm), 2 otočná kola (1 x s dvojitou brzdou), 2 pevná kola
- Ochrana proti vniknutí vláken – chrání ložiska před nečistotami a vlákny
- Snadný pohyb i při vysokém dynamickém zatížení
- Šedá hladká elastická kola umožňují tichý chod
- Stabilní madlo, pevně přimontované k tělu
- Pro úložný vkladací systém HAZET, 2-komponentní pěnová vložka
- Nosnost na patro: 50 kg
- Celková nosnost (dynamická): 150 kg
- Celková nosnost (statická): 150 kg
- Barva: Modrá HAZET

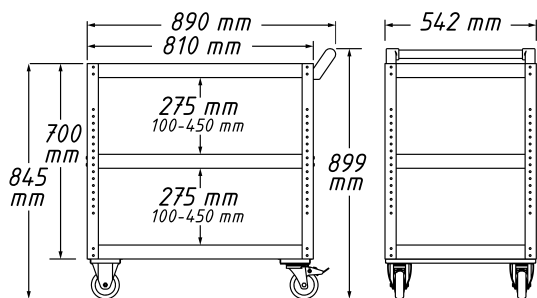
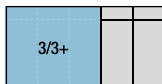

YouTube Clip



HAZET No.	d x š x v mm	EAN-No. 4000896+	€
167-3	890x542x899	205332	231,-

167-3 S Servisní vozík *Assistant*[®]

Made in Germany

• Individuální možnosti upevnění přes obdélníkový dřevový rastr na boční stěně



- 15násobně výškově nastavitelný (prostřední police)
- Další police a protiskluzové rohože (2x 180-38) k dostání jako volitelné příslušenství
- Stabilní konstrukce z ocelového plechu, nosnost každé police: 50 kg
- Velká kola uložená v kuličkových ložiscích (Ø 100 mm), 2 otočná kola (1 x s dvojitou brzdou), 2 pevná kola
- Ochrana proti vniknutí vláken – chrání ložiska před nečistotami a vlákny
- Snadný pohyb i při vysokém dynamickém zatížení
- Šedá hladká elastická kola umožňují tichý chod
- Stabilní madlo, pevně přimontované k tělu
- Pro úložný vkladací systém HAZET, 2-komponentní pěnová vložka
- Nosnost na patro: 50 kg
- Celková nosnost (dynamická): 150 kg
- Celková nosnost (statická): 150 kg
- Barva: Modrá HAZET
- Možnosti uchycení po straně pro rozsáhlé příslušenství ze sortimentu HAZET (volitelné)
- Barva: HAZET modrá / boční stěny černé

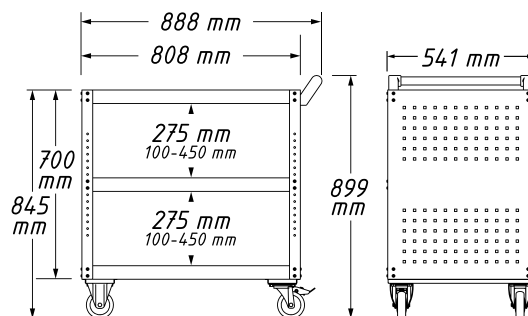

Následující příslušenství je k dostání zvlášť:

HAZET No.	Označení		HAZET No.	Označení	
112/11	Držák nářadí	47	180-24	Držák dokumentů	51
179-35	Držák dóz	50	180-34	Držák papírové role	51
179 N-33	Koš na papír	50	180-35	Držák dóz	51

HAZET No.	d x š x v mm	kg	EAN-No. 4000896+	€
167-3 S	888x541x899	27	207206	253,80



Provozní a dílenské zařízení

Dílenský vozík *Assistent*[®]



167 T Servisní vozík *Assistent*[®]

Made in Germany

• Robustní ochrana proti nárazu na všech důležitých vzpěrách na ochranu citlivých míst, jako např. karoserie a vysoce kvalitních ráfků

- Stůl sklopitelný o 90° dolů
- 15násobně výškově nastavitelný (rastr: 25 mm)
- Stabilní svařovaná konstrukce
- Kola uložena v kuličkových ložiskách (Ø 50 mm), 4 říditelná kolečka, z toho 2 kolečka s brzdou
- Snadný pohyb i při vysokém dynamickém zatížení
- Šedá hladká elastická kola umožňují tichý chod
- Hodí se pod vozidla se světlou výškou větší než 130 mm
- Nosnost stolu: 35 kg
- Maximální celková nosnost (dynamická): 150 kg
- Dodávka, plochý balík (v x š x h: cca 110 x 930 x 780 mm)
- Příslušenství 112/11 · 179-35 · 179 N-35 · 180-24 · 180-35 pouze ve spojení s 167 T-26
- Celková nosnost (dynamická): 150 kg
- Celková nosnost (statická): 150 kg
- Barva: Modrá HAZET



YouTube Clip

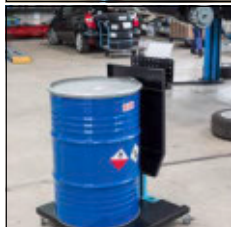
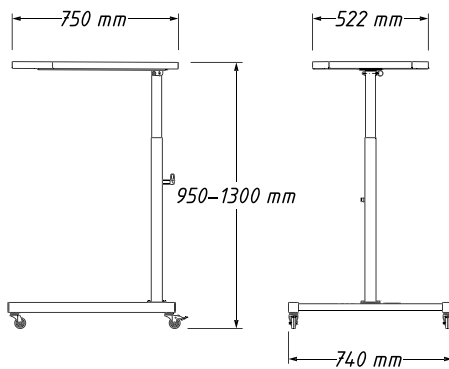

Následující příslušenství je k dostání zvlášť:

HAZET No.	Označení		HAZET No.	Označení	
112/11	Držák nářadí	47	179-35	Držák dóz	50
162 C-5	Vana na drobné součásti	49	180-24	Držák dokumentů	51
167 T 23	Odkládací dno	49	180-35	Držák dóz	51
167 T 26	Děrovaná stěna	49			

*) Příslušenství pouze ve spojení s 167 T-26

HAZET No.	d x š x v mm		EAN-No. 4000896+	€
167 T	773x740x1345	17,9	210503	322,30





Pracovní stoly / skříňky

177 W Pojízdný pracovní stůl

Made in Germany

- Velká ložiskově uložená kola (Ø 125 mm), snadný pohyb i při vysokém dynamickém zatížení
- 2 řiditelná kolečka s dvojitým zastavením: zabrzděná kolečka brání odjetí, zabrzděná otočná ložiska brání otáčení řiditelných koleček, např. na šikmých plochách
- Ochranný kroužek zabraňuje vniku nečistot a vláken
- Šedá hladká elastická kola umožňují tichý chod
- Dvoustupňový koncept zajištění:
 - Centrální zamykání přes cylindrický zámek s 2 klíči
 - Jednotlivé západky zabraňují nechtěnému otevření
 - 100% výsuv s válečkovým vedením
- Odkládací plochy v regálové části:
 - Nosné zatížení nahoře: 15 kg / dole: 35 kg
 - Regálová police přestavitelná
- Volitelné: 177 W-21: dveře pro pravý díl regálu, se zámkem, včetně 2 klíčů
- Celková nosnost (dynamická): 500 kg
- Celková nosnost (statická): 750 kg
- Pracovní deska: Dřevo Multiplex hrušeň, vyměnitelné
- Nosnost na zásuvku: 20 kg
- Barva: Modrá HAZET



Následující příslušenství je k dostání zvlášť:

HAZET No.	Označení		HAZET No.	Označení	
112/11	Držák nářadí	47	179 N-33	Koš na papír	50
161-1	Protiskuzová podložka	48	179 W-40	Základní držák	51
161 T-347x120/5	Oddělovací plechy	48	179 W-42	Držák notebooku	51
161 T-347x60/5	Oddělovací plechy	48	180-24	Držák dokumentů	51
177 W-21	Dveře	49	180-34	Držák papírové role	51
179-35	Držák dóz	50	2175 N	Paralelní svěrák	51

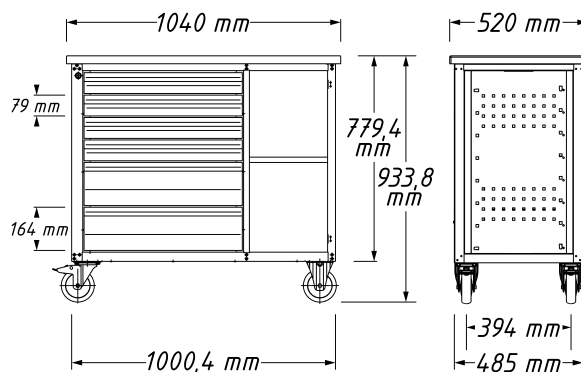
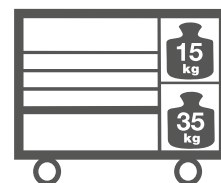
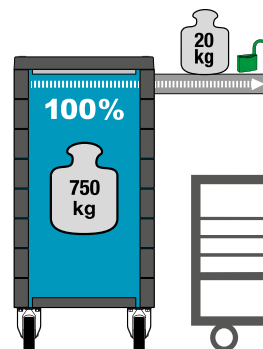
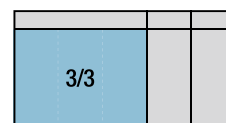

HAZET No.	$d \times š \times v$ mm	79x527x348 mm	164x527x348 mm		kg	EAN-No. 4000896+	€
• 4x nízká zásuvka a 2x vysoká zásuvka, navíc 2 odkládací plochy v regálové části							
177 W-6	1040x520x934	4x	2x	6x	85	154630	1161,-
• 6x nízká zásuvka a 1x vysoká zásuvka, navíc 2 odkládací plochy v regálové části							
177 W-7	1040x520x934	6x	1x	7x	85	155644	1197,-



Provozní a dílenské zařízení

Pracovní stoly / skříňky



179 NW Pojízdný pracovní stůl

Made in Germany

• **Větší odkládací prostor než předchozí model**

- 30 mm dřevěná pracovní plocha Multiplex hrušeň, naolejovaná, vyměnitelná
- Včetně 9násobně přestavitelného vloženého dna a pevně montovaných dveří
- Průchod kabelu na zadní stěně umožňuje např. nabíjení akumulátorových přístrojů při zavřených dveřích
- Kompletně svařovaná konstrukce celého korpusu pro každodenní tvrdé dílenské nasazení
- Dodatečný děrový rastr pro držák nástrojů, např. HAZET 112-230
- Optimalizovaná poddajná ochrana hran na všech čtyřech rozích s opravdovou ochranou proti nárazům díky vnitřnímu konceptu tlumení
- Flexibilní montáž svěraku (vpředu, vpravo, vlevo), např. HAZET 2175 N podle předlohy vrtací šablony
- **Podvozek:**
 - Velká, silně zatížitelná kola (Ø 125 mm) s přesným kuličkovým ložiskem a dvojitou kuličkovou klecí ve sklápěcím ložisku, snadný pohyb i při vysoké dynamické zátěži
 - 2 řídicí kolečka s dvojitou brzdou: zabrzděné kolečko zabraňuje odvalení, zabrzděné otočné ložisko zabraňuje otočení řídicího kolečka, např. na šikmé ploše
 - Ochranný kroužek zabraňuje vniknutí nečistot a vláken
 - Elastická kola umožňují tichý chod
- **Koncept zajištění:**
 - Vzájemné zajištění zásuvek pro minimální riziko překlopení
 - Uprostřed umístěný zámek (centrální zamýkání a vložka zámku) uzamkne současně dveře a zásuvky
 - Již pouze jeden klíč pro současné zamknutí dveří a zásuvek (rozsah dodávky 2 klíče)
 - 180° otočení, zabraňuje zlomení klíče
 - 100 % výsuv pomocí kuličkové uložených teleskopických lišt – samočinné zavírání
- 1 zásuvka pro vysoké zatížení, nosnost 40 kg, 166 mm vysoká
- 6 zásuvek, nosnost 25 kg, 81 mm vysoká
- 2 odkládací plochy v oddílu regálů, nahoře: 15 kg / dole: 35 kg
- Celková nosnost (dynamická): 750 kg
- Celková nosnost (statická): 1000 kg
- Pracovní deska: Dřevo Multiplex hrušeň, vyměnitelné
- Barva: Modrá HAZET



(E)

Následující příslušenství je k dostání zvlášť:

HAZET No.	Označení		HAZET No.	Označení	
112/11	Držák nářadí	47	179 N W-23	Regalová police	50
161 T-179 N/4	Sada oddělovacích plechů	49	179 N W-26	Svislá dřevovaná tabule na nářadí	51
161 T-179 N/4 H	Sada oddělovacích plechů	49	179 W-40	Základní držák	51
161 T-395x120/5	Oddělovací plechy	48	179 W-42	Držák notebooku	51
161 T-395x60/5	Oddělovací plechy	48	180-24	Držák dokumentů	51
179-35	Držák dóz	50	180-34	Držák papírové role	51
179 N-19	Sběrač malých dílů	50	180-35	Držák dóz	51
179 N-33	Koš na papír	50	2175 N	Paralelní svěrak	51
179 N W-22	Regalová zásuvka	50			

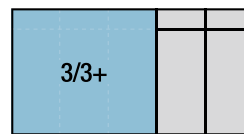

YouTube Clip

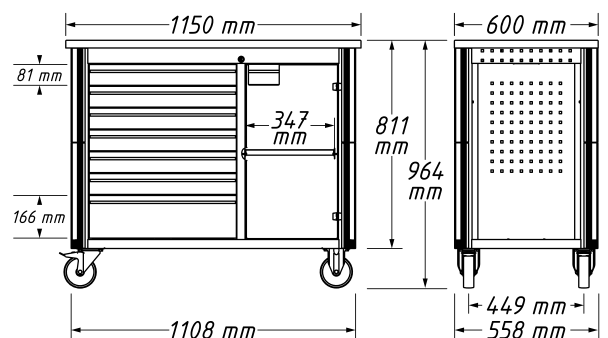
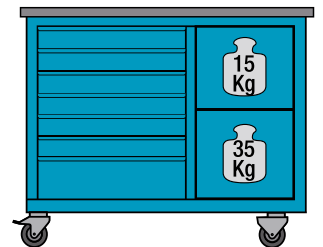
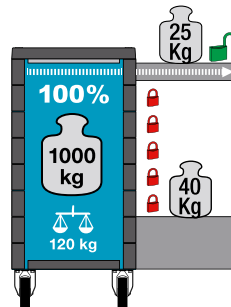

HAZET No.	d x š x v mm				EAN-No.	€
179 N W-7	1150x600x964	81 x 522 x 398 mm	166 x 522 x 398 mm	120 kg	4000896+	1881,-
		6x	1x		219629	



130 Pracovní stůl

Made in Germany

- 40 mm silná vrstvená buková deska
- Ocelová ochranná hrana vpředu
- Dobrá stabilita díky stabilnímu ocelovému rámu
- Celková nosnost (statická): 1000 kg



HAZET No.	d x š x v mm	kg	EAN-No. 4000896+	€
130-1	2000x760x845	89	003358	1068,-

111 L Skříň na nářadí

Made in Germany

- Žaluzie, uzamykatelné včetně visacího zámku se 2 klíči
- Včetně závěsného zařízení
- Prázdná, pro libovolné osazení

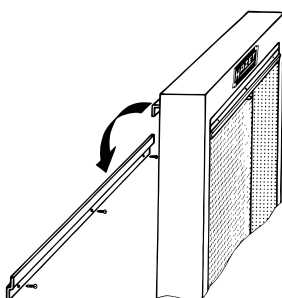

HAZET No.	d x š x v mm	kg	EAN-No. 4000896+	€
111 L	640x250x1000	27	003266	600,-

111 Dílenský vozík se sadou nářadí

- Závěsné uspořádání, držáky nářadí a pěnové vložky pro sady nástrčných klíčů

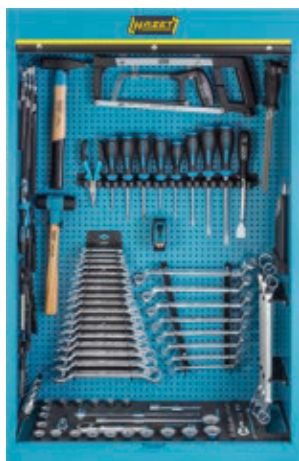

111 Dílenský vozík se sadou nářadí



111 L



824 • 0.5x23

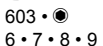

850 • 4 • 4.5 • 5 • 5.5 • 6 • 7 • 8 • 9 • 10 • 11



863 HP • 6 • 7 • 8 • 9

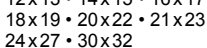

867-2 • 10 • 11 • 12 • 13 • 14 • 15 • 16 • 17 • 18 • 19 • 21 • 22 • 24

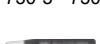

630 • 6x7 • 8x9 • 10x11 • 12x13 • 14x15 • 16x17 • 18x19 • 20x22 • 21x23 • 24x27 • 30x32



730 • 730-3 • 730-6



746-1

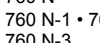

748 B • 748 b-3 • 748 b-4 • 748 b-5 • 748 b-6

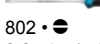

760 N • 760 N-1 • 760 N-2 • 760 N-3



802 • 0.8x4 • 1x5.5 • 1.2x8 • 1.6x10



802-PH • PH 1 • PH 2



802-PZ • PZ 1 • PZ 2



824 • 0.5x23

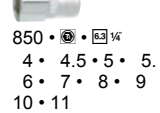

850 • 4 • 4.5 • 5 • 5.5 • 6 • 7 • 8 • 9 • 10 • 11



863 HP • 6 • 7 • 8 • 9

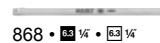

867-2 • 10 • 11 • 12 • 13 • 14 • 15 • 16 • 17 • 18 • 19 • 21 • 22 • 24



630 • 6x7 • 8x9 • 10x11 • 12x13 • 14x15 • 16x17 • 18x19 • 20x22 • 21x23 • 24x27 • 30x32



730 • 730-3 • 730-6

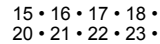

746-1

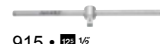

748 B • 748 b-3 • 748 b-4 • 748 b-5 • 748 b-6

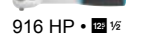

760 N • 760 N-1 • 760 N-2 • 760 N-3

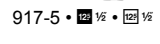

802 • 0.8x4 • 1x5.5 • 1.2x8 • 1.6x10



802-PH • PH 1 • PH 2



802-PZ • PZ 1 • PZ 2

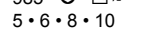

824 • 0.5x23

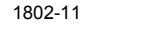

850 • 4 • 4.5 • 5 • 5.5 • 6 • 7 • 8 • 9 • 10 • 11



863 HP • 6 • 7 • 8 • 9



867-2 • 10 • 11 • 12 • 13 • 14 • 15 • 16 • 17 • 18 • 19 • 21 • 22 • 24



630 • 6x7 • 8x9 • 10x11 • 12x13 • 14x15 • 16x17 • 18x19 • 20x22 • 21x23 • 24x27 • 30x32



730 • 730-3 • 730-6

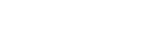

746-1

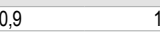

748 B • 748 b-3 • 748 b-4 • 748 b-5 • 748 b-6



760 N • 760 N-1 • 760 N-2 • 760 N-3

802 • 0.8x4 • 1x5.5 • 1.2x8 • 1.6x10

802-PH • PH 1 • PH 2

802-PZ • PZ 1 • PZ 2

824 • 0.5x23

850 • 4 • 4.5 • 5 • 5.5 • 6 • 7 • 8 • 9 • 10 • 11

863 HP • 6 • 7 • 8 • 9

867-2 • 10 • 11 • 12 • 13 • 14 • 15 • 16 • 17 • 18 • 19 • 21 • 22 • 24

630 • 6x7 • 8x9 • 10x11 • 12x13 • 14x15 • 16x17 • 18x19 • 20x22 • 21x23 • 24x27 • 30x32

730 • 730-3 • 730-6

746-1

748 B • 748 b-3 • 748 b-4 • 748 b-5 • 748 b-6

760 N • 760 N-1 • 760 N-2 • 760 N-3

802 • 0.8x4 • 1x5.5 • 1.2x8 • 1.6x10

802-PH • PH 1 • PH 2

802-PZ • PZ 1 • PZ 2

824 • 0.5x23

850 • 4 • 4.5 • 5 • 5.5 • 6 • 7 • 8 • 9 • 10 • 11

863 HP • 6 • 7 • 8 • 9

867-2 • 10 • 11 • 12 • 13 • 14 • 15 • 16 • 17 • 18 • 19 • 21 • 22 • 24

630 • 6x7 • 8x9 • 10x11 • 12x13 • 14x15 • 16x17 • 18x19 • 20x22 • 21x23 • 24x27 • 30x32

730 • 730-3 • 730-6

746-1

748 B • 748 b-3 • 748 b-4 • 748 b-5 • 748 b-6

760 N • 760 N-1 • 760 N-2 • 760 N-3

802 • 0.8x4 • 1x5.5 • 1.2x8 • 1.6x10

802-PH • PH 1 • PH 2

802-PZ • PZ 1 • PZ 2

824 • 0.5x23

850 • 4 • 4.5 • 5 • 5.5 • 6 • 7 • 8 • 9 • 10 • 11

863 HP • 6 • 7 • 8 • 9

867-2 • 10 • 11 • 12 • 13 • 14 • 15 • 16 • 17 • 18 • 19 • 21 • 22 • 24

630 • 6x7 • 8x9 • 10x11 • 12x13 • 14x15 • 16x17 • 18x19 • 20x22 • 21x23 • 24x27 • 30x32

730 • 730-3 • 730-6

746-1

748 B • 748 b-3 • 748 b-4 • 748 b-5 • 748 b-6

760 N • 760 N-1 • 760 N-2 • 760 N-3

802 • 0.8x4 • 1x5.5 • 1.2x8 • 1.6x10

802-PH • PH 1 • PH 2

802-PZ • PZ 1 • PZ 2

824 • 0.5x23

850 • 4 • 4.5 • 5 • 5.5 • 6 • 7 • 8 • 9 • 10 • 11

863 HP • 6 • 7 • 8 • 9

867-2 • 10 • 11 • 12 • 13 • 14 • 15 • 16 • 17 • 18 • 19 • 21 • 22 • 24

630 • 6x7 • 8x9 • 10x11 • 12x13 • 14x15 • 16x17 • 18x19 • 20x22 • 21x23 • 24x27 • 30x32

730 • 730-3 • 730-6

746-1

748 B • 748 b-3 • 748 b-4 • 748 b-5 • 748 b-6

760 N • 760 N-1 • 760 N-2 • 760 N-3

802 • 0.8x4 • 1x5.5 • 1.2x8 • 1.6x10

802-PH • PH 1 • PH 2

802-PZ • PZ 1 • PZ 2

824 • 0.5x23

850 • 4 • 4.5 • 5 • 5.5 • 6 • 7 • 8 • 9 • 10 • 11

863 HP • 6 • 7 • 8 • 9

867-2 • 10 • 11 • 12 • 13 • 14 • 15 • 16 • 17 • 18 • 19 • 21 • 22 • 24

630 • 6x7 • 8x9 • 10x11 • 12x13 • 14x15 • 16x17 • 18x19 • 20x22 • 21x23 • 24x27 • 30x32

730 • 730-3 • 730-6

746-1

748 B • 748 b-3 • 748 b-4 • 748 b-5 • 748 b-6

760 N • 760 N-1 • 760 N-2 • 760 N-3

802 • 0.8x4 • 1x5.5 • 1.2x8 • 1.6x10

802-PH • PH 1 • PH 2

802-PZ • PZ 1 • PZ 2



Provozní a dílenské zařízení

Pracovní stoly / skříňky



0-111 Sada náradí

- 116 dílů
- Obsah viz sortiment 111/116,
- bez skříně



HAZET No.	kg		EAN-No. 4000896+	€
0-111/116	17	116	000098	1809,-

111 Držák náradí

Made in Germany



HAZET No.	EAN-No. 4000896+	€
• Držák, např. na 630-6x7 až -20x22 použití společně s 111-03 L		
111-03 R	002849	5,05
• Držák, použití společně s 111-03 R		
111-03 L	002832	5,05
• Držák, na 4 kusy 1/2 nástrčných hlavíc		
111-04	002856	5,55
• Držák, např. na 730-3 až -6 sekáč, 746-1 dűlčík, 748 vyrážek závlaček		
111-05	002863	7,35

Made in Germany



HAZET No.	EAN-No. 4000896+	€
• Hák, např. na 279, 760 N, 2100/7 R atd.		
111-06	002870	2,45
• Držák, např. na 603 očko-ploché klíč nebo 2140 kladivo atd.		
111-10	002917	4,30
• Držák, např. na svinovací metr		
111-15	002962	4,10

Made in Germany



111 Držák náradí

HAZET No.	EAN-No. 4000896+	€
• Hák na náradí Ø 6 mm, délka 75 mm		
111-21	003020	2,70
• Háky na náradí		
111-22	003037	4,10
• Samořezné šrouby		
111-28	003099	0,45

112 Držák náradí

- Montáž na perforovanou stěnu s pravouhlými děrami
- Např. pro zadní a boční stěny dílenských vozíků *Assistent* 167 T · 167 XXL · 167-3 S · 177 · 178 N · 179 · 179 A XXL · 179 BIG-1 · 179 N · 179 N X · 179 N XL · 179 N XXL · 179 T XXL · 179 XL · 179 XXL · 179-10 a dílenských stolů 177 W · 179 N W · 179 W



HAZET No.	EAN-No. 4000896+	€
• Dvojitý hák, 30 mm dlouhý, např. na náradí s T-rukojetí		
112-230	103898	6,70
• Dvojitý hák, 60 mm dlouhý, např. na náradí s T-rukojetí		
112-260	103881	6,70
• Hák, 25 mm dlouhý, např. pro náradí se závěsným otvorem		
112-325	103874	4,05
• Hák, 50 mm dlouhý, např. pro náradí se závěsným otvorem		
112-350	103867	3,80
• Dvojitý hák, široký, 40 mm dlouhý, např. pro momentový klíč		
112-440	103850	6,70
• Dvojitý hák, široký, 50 mm dlouhý, např. pro momentový klíč		
112-450	103843	6,70
• Svorka, Ø 12 mm, např. pro přepínací ráčnu 863-1, 863 F, P, S nebo i přepínací ráčnu na bity 863 B GL, BKC a BK		
112-612	103836	3,55
• Svorka, Ø 18 mm, např. pro přepínací ráčny 8816-1, 8816 F, P nebo S a 916 K		
112-618	103720	3,55
• Svorka, Ø 24 mm, např. pro přepínací ráčny 916-1, 916 F, SP, S		
112-624	103713	3,55
• Kelímeček, Ø 30 mm, 80 mm vysoký, např. na kolíky, dűlčíky atd.		
112-830	103706	3,55
• Kelímeček, Ø 50 mm, 114 mm vysoký, např. na rýsovací jehly 2150-1 apod.		
112-850	103690	5,15
• Sada držáků náradí		
• Pro dílenský vozík <i>Assistent</i> 167 · 177 · 178 N · 179 · 179 BIG · 179 N · 179 N X · 179 N XL · 179 N XXL · 179 T · 179 XL · 179 XXL a pracovní stůl <i>Assistent</i> 177 W · 179 W · 179 N W		
Obsah: 112-230 · 260 · 325 · 350 · 440 · 450 · 612 · 618 · 624 · 830 · 850		
112/11	11	104239
		48,95



2025 X Držák nářadí

- Univerzální upínací lišty
- Připraveno k umístění xlibovolných dílů
- Korpus se 2 podélnými dírami pro variabilní přišroubování, také na děrovanou desku
- 2 upínací oka jsou šetrná k materiálu každého objektu
- Upínací oka z plastu odolávajícímu oleji a chladu, pružná, odolná
- Korpus z eloxovaného lehkého kovu



HAZET No.	l mm	EAN-No. 4000896+	€
• 20 upínacích spon 2025 X	440	010301	20,45
• 6 upínacích spon 2025 X-1	150	010424	10,20

2025 X Háčky na nářadí a vodící lišty

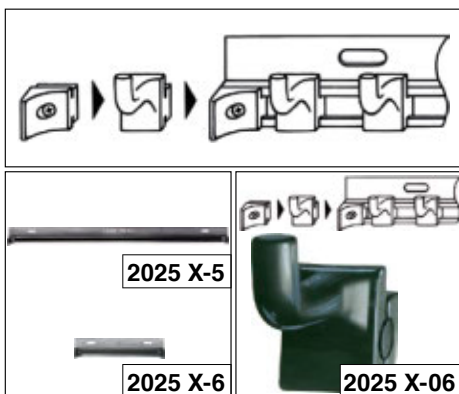

HAZET No.	l mm	€
• Kompletní lišta na nářadí se třemi háčky na nářadí		
• 150 mm délka		
• Upevnění na stěnu		
2025 X-6/4	–	15,30
• Háčky na nářadí, samosvorné,		
• Variabilní vložení do vodící lišty 2025 X-5 a 2025 X-6		
2025 X-06	–	1,90
• Vodící lišta pro výše uvedené háčky		
2025 X-5	440	19,15
2025 X-6	150	10,10

Příslušenství dílenského vozíku / dílenského stolu

161 T Oddělovací plechy

Made in Germany
• Pro HAZET *Assistant*



HAZET No.	€
• Oddělovací plechy, 5dílné, pro plochou zásuvku	
• Pro dílenský vozík <i>Assistant</i> 177 a pracovní stůl <i>Assistant</i> 177 W	
• D 347 x V 60 mm	
161 T-347x60/5	17,15
• Oddělovací plechy, 5dílné, pro vysokou zásuvku	
• Pro dílenský vozík <i>Assistant</i> 177 a pracovní stůl <i>Assistant</i> 177 W	
• D 347 x V 120 mm	
161 T-347x120/5	23,55
• Oddělovací plechy, 5-dílné, pro plochou zásuvku	
• Pro dílenské vozíky <i>Assistant</i> 179 N(X) · 179 N XL · 179 N XXL a pracovní stůl <i>Assistant</i> 179 N W	
• D 395 x V 60 mm	
161 T-395x60/5	12,75
• Oddělovací plechy, 5-dílné, pro vysokou zásuvku	
• Pro dílenské vozíky <i>Assistant</i> 179 N(X) · 179 N XL · 179 N XXL a pracovní stůl <i>Assistant</i> 179 N W	
• D 395 x V 120 mm	
161 T-395x120/5	15,90

173 Protiskluzová podložka



HAZET No.	kg	EAN-No. 4000896+	€
• Protiskluzová podložka			
• Pro dílenský vozík <i>Assistant</i> 173 · 179 XL · 179 N XL			
• D 694 x Š 395 mm			
173-38	0,15	089789	18,40
• Protiskluzová podložka			
• Pro dílenský vozík <i>Assistant</i> 179 · 179-10 · 179 BIG-1 · 180 · 180 K-4 a pracovní stůl <i>Assistant</i> 179 W			
• D 529 x Š 394 mm			
180-38	0,1	120819	15,10
• Protiskluzová podložka			
• Pro dílenský vozík <i>Assistant</i> 168 · 169 N · 174 · 176 · 177 · 178 a pracovní stůl <i>Assistant</i> 177 W			
• D 523 x Š 348 mm			
161-1	0,11	058884	15,-

161 Přísavný držák

Made in Germany

- **Přísavný držák s kloubem a otočnými přísavkami Ø 120 mm,**
- Pro *Assistant* 162 C · 162 N · 166 C · 166 N · 171 · 172 HD · 176 · 178 · 179 · 179 XL · 179 XXL · 180 a 180 K-4
- **Cena za kus / použijte v páru**



*) Používá se v páru

HAZET No.	EAN-No. 4000896+	€
161-9	004867	204,10



Provozní a dílenské zařízení

Příslušenství dílenského vozíku / dílenského stolu



Příslušenství pro vozíky na nářadí, materiál a pro montážní vozíky

HAZET No.	EAN-No. 4000896+	€
		
<ul style="list-style-type: none"> • Sada oddělovacích plechů, 4dílná, pro plochou zásuvku • Pro dílenské vozíky HAZET <i>Assistant</i> 174 · 178 N-7 · 178 N K-3 		
161 T-178 N/4	206384	13,05
		
<ul style="list-style-type: none"> • Sada oddělovacích plechů, 4dílná, pro plochou zásuvku • Pro dílenské vozíky <i>Assistant</i> 179 N · 179 NT · 179 NX a pracovní stůl <i>Assistant</i> 179 N W • D 516xV 58 mm 		
161 T-179 N/4	215485	13,65
		
<ul style="list-style-type: none"> • Sada oddělovacích plechů, 4dílná, pro vysokou zásuvku • Pro dílenský vozík <i>Assistant</i> 179 N · 179 NT · 179 NX a pracovní stůl <i>Assistant</i> 179 N W • D 516xV 118 mm 		
161 T-179 N/4 H	226979	21,20
		
<ul style="list-style-type: none"> • Sada oddělovacích plechů, 5dílná, pro plochou zásuvku • Pro dílenský vozík <i>Assistant</i> 179 N XL • D 688xV 58 mm 		
161 T-179 N XL/5	215492	16,20
		
<ul style="list-style-type: none"> • Sada oddělovacích plechů, 5dílná, pro vysokou zásuvku • Pro dílenský vozík <i>Assistant</i> 179 N XL • D 688xV 118 mm 		
161 T-179 N XL/5 H	226962	25,45
		
<ul style="list-style-type: none"> • Sada oddělovacích plechů, 6dílná, pro plochou zásuvku • Pro dílenský vozík <i>Assistant</i> 179 N XXL • D 863xV 58 mm 		
161 T-179 N XXL/6	215508	19,05
		
<ul style="list-style-type: none"> • Sada oddělovacích plechů, 6dílná, pro vysokou zásuvku • Pro dílenský vozík <i>Assistant</i> 179 N XXL • D 863xV 118 mm 		
161 T-179 N XXL/6 H	226955	33,95
		
<ul style="list-style-type: none"> • Vana na drobné součástky • Pro dílenské vozíky HAZET <i>Assistant</i> 162 C · 166 C · 167 		
162 C-5	078189	13,35
		
<ul style="list-style-type: none"> • Oddělovací plech pro mezipolici • Pro dílenské vozíky HAZET <i>Assistant</i> 162 C a 166 C 		
162 C-6	079810	3,55

Příslušenství pro vozíky na nářadí, materiál a pro montážní vozíky

HAZET No.	EAN-No. 4000896+	€
		
<ul style="list-style-type: none"> • Oddělovací plechy, 5dílné pro mezipolici • Pro dílenské vozíky <i>Assistant</i> 162 C · 166 C 		
162 C-6/5	120772	16,70
		
<ul style="list-style-type: none"> • Odkládací dno • Pro dílenský vozík <i>Assistant</i> 167 T 		
167 T 23	209972	88,05
		
<ul style="list-style-type: none"> • Děrovaná stěna • Pro dílenský vozík <i>Assistant</i> 167 T 		
167 T 26	209996	57,55
		
<ul style="list-style-type: none"> • Oddělovací plechy, ploché, 5dílné • Pro dílenské vozíky <i>Assistant</i> 173 · 179 · 179-10 · 179 BIG · 179 XL · 179 XXL · 179 A XXL · 179 T XXL · 180 · 180 K-4 a pracovní stůl <i>Assistant</i> 179 W • V 60 x D 397 mm (pro plochou zásuvku) 		
173-31/5	090150	18,50
		
<ul style="list-style-type: none"> • Sada oddělovacích plechů, vysoká, 5dílná • Pro dílenské vozíky <i>Assistant</i> 173 · 179 · 179-10 · 179 BIG · 179 XL · 179 XXL · 179 A XXL · 179 T XXL · 180 a pracovní stůl <i>Assistant</i> 179 W • D 397 x V 120 mm (pro vysokou zásuvku) 		
173-32/5	120796	19,25
		
<ul style="list-style-type: none"> • Protiskluzová podložka • Pro dílenský vozík <i>Assistant</i> 173 · 179 XL · 179 N XL • D 694 x Š 395 mm 		
173-38	089789	18,40
		
<ul style="list-style-type: none"> • Dveře, uzamykatelné • Pro pravou část skříně • Pro pracovní stůl <i>Assistant</i> 177 W 		
177 W-21	154739	99,90



Příslušenství pro vozíky na nářadí, materiál a pro montážní vozíky

HAZET No.	EAN-No. 4000896+	€
		
<ul style="list-style-type: none"> • Držák dóz, pro 3 dózy • Pro dílenské vozíky <i>Assistant</i> 167-3 S · 167 T · 177 · 178 N · 179 N · 179 N X · 179 N XL · 179 N XXL a pracovní stůl <i>Assistant</i> 177 W · 179 N W a rovněž zadní dveře 179-21 		
179-35	141074	38,35
		
<ul style="list-style-type: none"> • Základní držák • Pro dílenský vozík <i>Assistant</i> 179 · 179 XL · 179 XXL • Pro obrazovky • Podle Vesa 75 a 100 • Nosnost: 5 kg 		
179-40	219575	157,80
		
<ul style="list-style-type: none"> • Sběrač malých dílů • Pro dílenský vozík <i>Assistant</i> 179 N · 179 N X · 179 N XL · 179 N XXL a pracovní stůl <i>Assistant</i> 179 N W 		
179 N-19	214457	23,05
		
<ul style="list-style-type: none"> • Boční dveře, uzamykatelné • Pro levou nebo pravou boční stěnu u <i>Assistant</i> 179 N · 179 N X · 179 N XL a 179 N XXL • Včetně 2 klíčů 		
179 N-21	215553	148,30
		
<ul style="list-style-type: none"> • Svislá děrovaná tabule na nářadí • Nasazovací na dílenský vozík <i>Assistant</i> 179 N · 179 N X • Uchycení doplňkového nářadí • Včetně sortimentu držáků 112-260 · 112-325 · 112-350 · 112-450 · 112-612 · 112-618 · 112-624 · 112-830 		
179 N-26	215522	154,90

Příslušenství pro vozíky na nářadí, materiál a pro montážní vozíky

HAZET No.	EAN-No. 4000896+	€
		
<ul style="list-style-type: none"> • Koš na papír • Pro dílenské vozíky <i>Assistant</i> 167-3 S · 177 · 178 N · 179 N · 179 N X · 179 N XL · 179 N XXL a pracovní stůl <i>Assistant</i> 177 W · 179 N W 		
179 N-33	236206	79,-
		
<ul style="list-style-type: none"> • Základní držák • Pro dílenský vozík <i>Assistant</i> 179 N · 179 N X · 179 N XL · 179 N XXL • Pro obrazovky • Podle Vesa 75 a 100 • Nosnost: 5 kg 		
179 N-40	215591	98,60
		
<ul style="list-style-type: none"> • Držák notebooku • Pro dílenský vozík <i>Assistant</i> 179 N · 179 N X · 179 N XL · 179 N XXL • Nosnost: 5 kg • Podle Vesa 75 a 100 • Pásek na suchý zip k zajištění notebooku v rozsahu dodávky 		
179 N-42	215621	135,60
		
<ul style="list-style-type: none"> • Dodatečná regálová zásuvka, pro pravý regálový díl • Pro pracovní stůl <i>Assistant</i> 179 N W • Rozměry (vnitřní) Š 318 x H 398 x V 77 mm • 25 kg nosnost se samočinným zavíráním 		
179 N W-22	219636	93,15
		
<ul style="list-style-type: none"> • Regálová police • Pro pracovní stůl <i>Assistant</i> 179 N W • Pro flexibilní instalaci v pravé regálové části • Nosnost 15 kg • Včetně 4 šroubů 		
179 N W-23	220199	30,75





Provozní a dílenské zařízení

Příslušenství dílenského vozíku / dílenského stolu

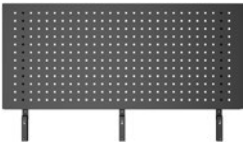
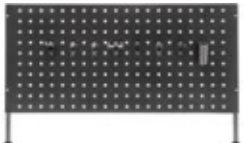
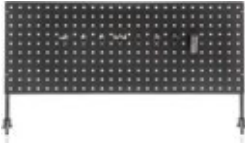

Příslušenství pro vozíky na nářadí, materiál a pro montážní vozíky

HAZET No.	EAN-No. 4000896+	€
		
<ul style="list-style-type: none"> • Svislá děrovaná tabule na nářadí • Lze našroubovat na pracovní stůl <i>Assistant</i> 179 N W • Uchycení doplňkového nářadí • Včetně 8dílného sortimentu držáků: 112-260 · 325 · 350 · 450 · 612 · 618 · 624 · 830 • Počet otvorů: 336 • D 1150xŠ 10xV 510 mm 		
179 N W-26	219612	167,70
		
<ul style="list-style-type: none"> • Svislá děrovaná tabule na nářadí • Nasazovací na dílenský vozík <i>Assistant</i> 179 N XL • Uchycení doplňkového nářadí • Včetně sortimentu držáků 112-260 · 112-325 · 112-350 · 112-450 · 112-612 · 112-618 · 112-624 · 112-830 		
179 N XL-26	215539	161,60
		
<ul style="list-style-type: none"> • Svislá děrovaná tabule na nářadí • Nasazovací na dílenský vozík <i>Assistant</i> 179 N XXL • Uchycení doplňkového nářadí • Včetně sortimentu držáků 112-260 · 112-325 · 112-350 · 112-450 · 112-612 · 112-618 · 112-624 · 112-830 		
179 N XXL-26	215546	167,40
		
<ul style="list-style-type: none"> • Základní držák • Pro pracovní stůl <i>Assistant</i> 177 W · 179 W · 179 N W • Pro obrazovky • Podle Vesa 75 a 100 • Nosnost: 5 kg 		
179 W-40	219568	98,45
		
<ul style="list-style-type: none"> • Držák notebooku • Pro pracovní stůl <i>Assistant</i> 177 W · 179 W · 179 N W • Nosnost: 5 kg • Podle Vesa 75 a 100 		
179 W-42	219551	141,50

Příslušenství pro vozíky na nářadí, materiál a pro montážní vozíky

HAZET No.	EAN-No. 4000896+	€
		
<ul style="list-style-type: none"> • Držák dokumentů, pro pracovní papír • Pro dílenské vozíky <i>Assistant</i> 167 T · 167-3 S · 177 · 178 N · 179 N · 179 N X · 179 N XL · 179 N XXL a pracovní stůl <i>Assistant</i> 177 W · 179 N W 		
180-24	110827	23,30
		
<ul style="list-style-type: none"> • Držák papírové role • Pro dílenské vozíky <i>Assistant</i> 167-3 S · 177 · 178 N · 179 N · 179 N X · 179 N XL · 179 N XXL a pracovní stůl <i>Assistant</i> 177 W · 179 N W • Včetně montážní sady (bez papírové role) • Pro papírové role do Ø maximálně 350 mm a šířky maximálně 280 mm 		
180-34	120840	65,50
		
<ul style="list-style-type: none"> • Držák dóz, pro 4 dózy • Včetně montážní sady pro dílenské vozíky <i>Assistant</i> 167-3 S · 167 T a pracovní stůl <i>Assistant</i> 179 N W • Zavěšení na rastr se čtvercovými otvory bez přídavného adaptéru 		
180-35	120826	38,35
		
<ul style="list-style-type: none"> • Protiskluzová podložka • Pro dílenský vozík <i>Assistant</i> 179 · 179-10 · 179 BIG-1 · 180 · 180 K-4 a pracovní stůl <i>Assistant</i> 179 W • D 529xŠ 394 mm 		
180-38	120819	15,10
		
<ul style="list-style-type: none"> • Paralelní svěrák • Kováno v zápustce • Šířka upínacích čelistí: 100 mm • Montáž na pracovní stůl <i>Assistant</i> 177 W · 179 W · 179 N W ve spojení s upevňovací sadou pro svěrák 179 N W-11/Montáž na dílenský vozík <i>Assistant</i> 177 ve spojení s dřevěnou podložkou 2175 N-11 		
2175 N	013685	233,50
		
<ul style="list-style-type: none"> • Podložka (ze dřeva) pro paralelní svěrák 2175 N • Montáž svěráku na dílenské stoly nebo dílenské vozíky <i>Assistant</i> 172 HD, 177, 180, 180 K-4 • Včetně montážního příslušenství 		
2175 N-11	013692	32,30



Dílenský vozík *Assistant* se sortimentem

177 Dílenský vozík *Assistant* se sortimentem

• Vozíky na nářadí, na materiál a montážní vozíky

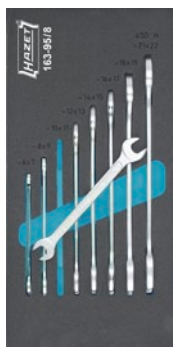
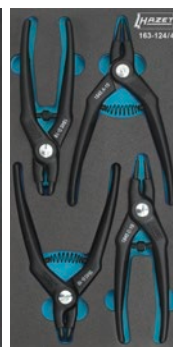
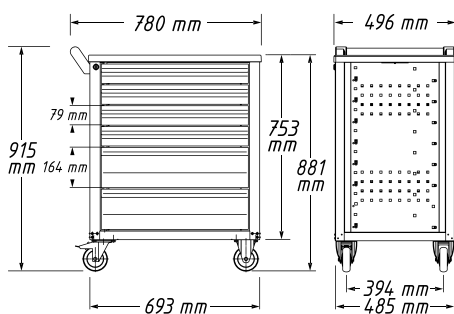
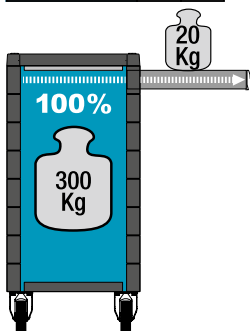
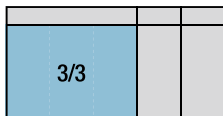



Provozní a dílenské zařízení

Dílenský vozík *Assistent* se sortimentem



177 Dílenský vozík *Assistent* se sortimentem



177-7



163-95/8 • ●

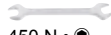

450 N • ●
6x7 • 8x9 • 10x11
12x13 • 14x15 • 16x17
18x19 • 21x22

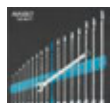

163-98/17 • ●



600 N • ●
6 • 7 • 8 • 9 • 10
11 • 12 • 13 • 14 • 15
16 • 17 • 18 • 19 • 21
22 • 24



163-124/4



1845 A-19



1845 B-19



1845 C-19



1845 D-19



163-182/9 • ●



828-T • ●
T 6 • T 7 • T 8
T 9 • T 10 • T 15
T 20 • T 25 • T 30



163-192/24 • ●, ○
1/2, 3/4



850 E • ●, 1/4
E 5 • E 6 • E 7 • E 8 • E 10



8502 • ●, 1/4
T 10 • T 15 • T 20 • T 25
T 27 • T 30 • T 40



900 E • ●, 1/2
E 10 • E 12 • E 14
E 16 • E 18 • E 20



992 • ●, 1/2
T 30 • T 40 • T 45
T 50 • T 55



2115-T/7 R • ●



163-224/57
●, ○, ○, ○, ○, ○, ○
1/2, 3/4, 1/2



810 SPC-6.3 • ●, 1/4



850 • ●, 1/4
5.5 • 6 • 7 • 8 • 9
10 • 11 • 12 • 13



863 HP • ●, 1/4



867-2 • ●, 1/4 • 1/4



868 • ●, 1/4 • 1/4



869 • ●, 1/4 • 1/4



900 • ●, 1/2
10 • 11 • 12 • 13 • 14
15 • 16 • 17 • 18 • 19
20 • 21 • 22 • 23 • 24
26 • 27 • 28 • 30 • 32



915 • ●, 1/2

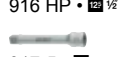

916 HP • ●, 1/2



917-5 • ●, 1/2 • 1/2



918-10 • ●, 1/2 • 1/2

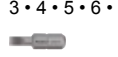

920 • ●, 1/2 • 1/2

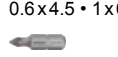

2204 • ●, 1/4
3 • 4 • 5 • 6 • 8

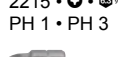

2208 • ●, 1/4
0.6x4.5 • 1x6 • 1.2x6.5

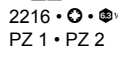

2215 • ●, 1/4
PH 1 • PH 3

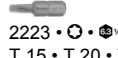

2216 • ●, 1/4
PZ 1 • PZ 2



2223 • ●, 1/4
T 15 • T 20 • T 25 • T 30



2250-1 • ●, 1/4 • 1/4



2304 • ●, 1/4 • 1/4



163-269/3



1859 SPC/3



163-297/26 • ●, ○, ○, ○



810 U-1/5 • ●, ○



810/6 • ●, ○



810 T/6 • ●



2105 Lg/9 H • ●



163-299/8

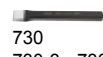

730
730-3 • 730-6



751 HS/5



2140-50



2128 N-1



2240 N/36
○, ○, ○, ○, ○, ○, ○, ○

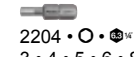

2204 • ●, 1/4
3 • 4 • 5 • 6 • 8

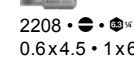

2208 • ●, 1/4
0.6x4.5 • 1x6 • 1.2x6.5



2215 • ●, 1/4
PH 1 • PH 3



2216 • ●, 1/4
PZ 1 • PZ 2

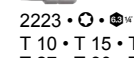

2223 • ●, 1/4
T 10 • T 15 • T 20 • T 25
T 27 • T 30 • T 40

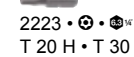

2223 • ●, 1/4
T 20 H • T 30 H

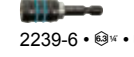

2239-6 • ●, 1/4

HAZET No.	d x š x v mm	79x527x348 mm	164x527x348 mm		kg		EAN-No. 4000896+	€
<ul style="list-style-type: none"> • 6 nízkých zásuvek a 1 vysoká zásuvka • Kompletní s 217dílnou sadou nářadí ve vložce z měkké pěny v úložném vkládacím systému 								
177-7/217	780x498x915	6x	1x	7x	62,8	217	202461	2328,-
177-7	780x498x915	6x	1x	7x	64,8	-	148592	773,-
<ul style="list-style-type: none"> • Sada nářadí • Ve vložkách z měkké pěny Safety Insert System 								
0-6/217	-	-	-	-	-	217	190492	1612,-



178 N Dílenský vozík *Assistent*

• Vozíky na nářadí, na materiál a montážní vozíky

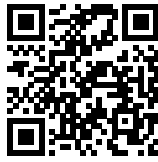

YouTube Clip

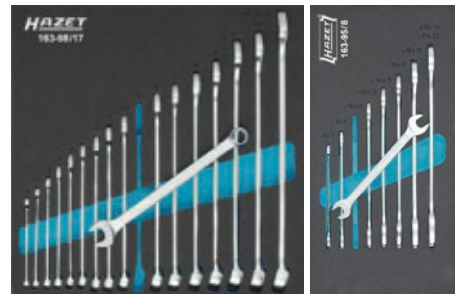
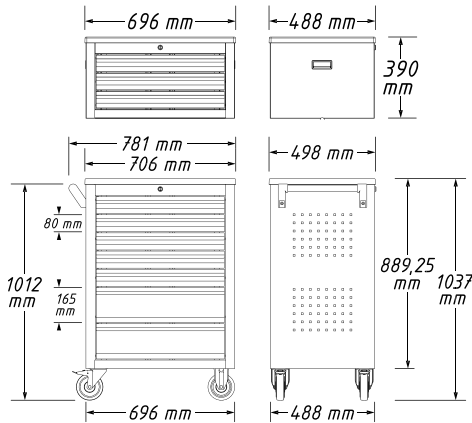
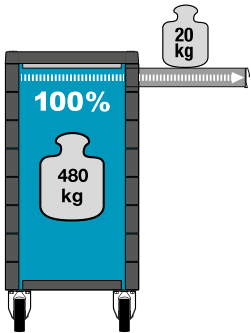
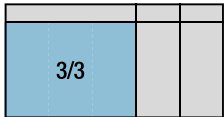

178 N-7

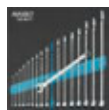

163-98/17 • ●



600 N • ●
6 • 7 • 8 • 9 • 10
11 • 12 • 13 • 14 • 15
16 • 17 • 18 • 19 • 21
22 • 24



810/6 • ●, ●



810 T/6 • ●



1859 SPC/3



2140-50



163-466/106

●, ○, ○, ○, ●, ●, ●, ●
● 1/4, ● 1/2, ● 3/8



751 HS/5



850 • ●, ● 1/4
4 • 4.5 • 5 • 5.5
6 • 7 • 8 • 9
10 • 11 • 12 • 13

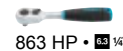

863 HP • ● 1/4



867-2 • ● 1/4 • ● 1/2



900 • ●, ● 1/2
10 • 11 • 12 • 13 • 14 • 15
16 • 17 • 18 • 19 • 21 • 22
24 • 27 • 30 • 32

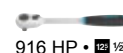

916 HP • ● 1/2



917-5 • ● 1/2 • ● 3/4



2105 Lg/9 H • ○



2116 Lg/8 H • ○



2240 N/51
●, ● 1/4, ● 1/2, ● 3/4, ● 1/2, ● 3/4, ● 1/2, ● 3/4



2250-1 • ● 1/4 • ● 3/8

HAZET No.	d x š x v mm	80x527x348 mm	165x527x348 mm	kg		EAN-No. 4000896+	€
• 5 nízkých a 2 vysoké zásuvky							
• Kompletní s 147dílnou sadou nářadí ve vložce z měkké pěny v úložném vkládacím systému							
178 N-7/147	781x498x1037	5x	2x	–	147	205080	1742,-
178 N-7	781x498x1037	5x	2x	74,1	–	202782	872,-
• Sada nářadí							
• Ve vložkách z měkké pěny Safety Insert System							
0-178 N/147	–	–	–	–	147	205097	931,-



Provozní a dílenské zařízení

Dílenský vozík *Assistent*[®] se sortimentem



Assistent[®]

– absolutní kvalita.

Dobrá práce od společnosti HAZET!

Konstrukce



Zpracování plechu



Svařovací robot



Prášková povrchová úprava



Montáž



Management kvality

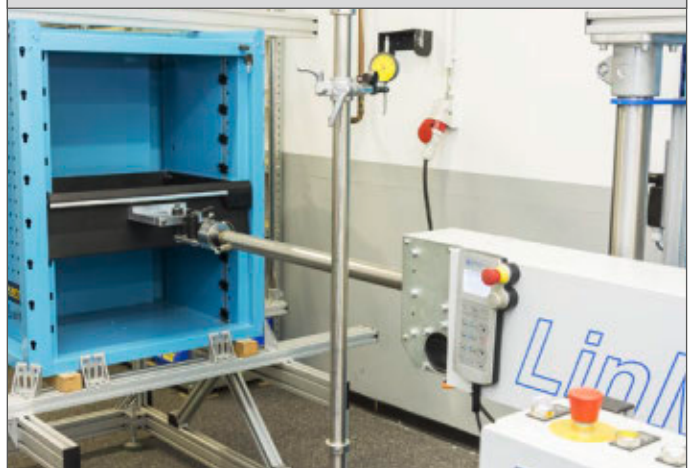

Made in Germany



179 N Dílenský vozík *Assistant*

• Vozíky na nářadí, na materiál a montážní vozíky

Ⓔ

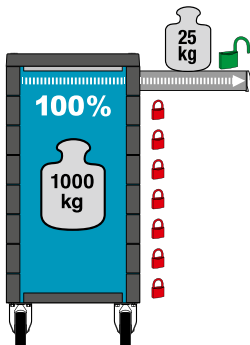
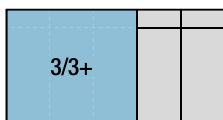

YouTube Clip

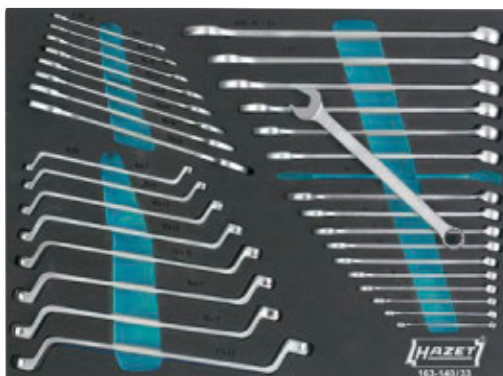
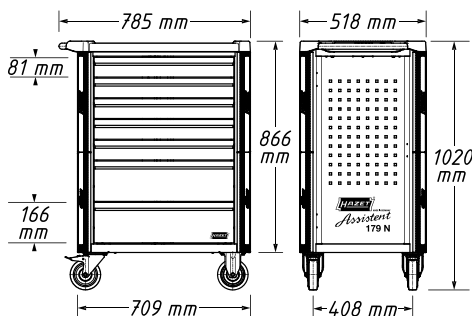



Provozní a dílenské zařízení

Dílenský vozík *Assistent* se sortimentem



179 N Dílenský vozík *Assistent*

(E)



179 N-7



163-138/77
⊕, ⊖, ⊕, ⊖, ⊕, ⊖, ⊕, ⊖



850 • ⊕ • ⊖
4 • 5 • 5.5 • 6
7 • 8 • 9 • 10
11 • 12 • 13 • 14



850 LG • ⊕ • ⊖
4 • 5 • 5.5 • 6
7 • 8 • 9 • 10
11 • 12 • 13



858-1 • ⊕
6 • 7 • 8 • 9 • 10



863 HP • ⊕



865 • ⊕



866 U • ⊕

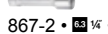

867-2 • ⊕
6 • 7 • 8 • 9 • 10

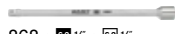

868 • ⊕
6 • 7 • 8 • 9 • 10



869 • ⊕
6 • 7 • 8 • 9 • 10



8501 • ⊕
3 • 4 • 5 • 6 • 8



8503 • ⊕
0.6x3.5 • 1x5.5 • 1.2x8



8506 • ⊕
PH 1 • PH 2



8507 • ⊕
PZ 1 • PZ 2



900 • ⊕
10 • 11 • 12 • 13 • 14
15 • 16 • 17 • 18 • 19
20 • 21 • 22 • 24 • 27
30 • 32



903 SLG • ⊕
17 • 19



915 • ⊕

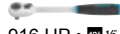

916 HP • ⊕

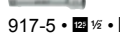

917-5 • ⊕
6 • 7 • 8 • 9 • 10



918-10 • ⊕
6 • 7 • 8 • 9 • 10

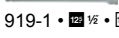

919-1 • ⊕
6 • 7 • 8 • 9 • 10



920 • ⊕
6 • 7 • 8 • 9 • 10



958-1 • ⊕
6 • 7 • 8 • 9 • 10



958-2 • ⊕
6 • 7 • 8 • 9 • 10



986 • ⊕
5 • 6 • 7 • 8
10 • 12 • 14 • 17



163-140/33 • ⊕, ⊖, ⊕, ⊖



450 N • ⊕
6x7 • 8x9 • 10x11
12x13 • 14x15 • 16x17
18x19 • 21x22



600 N • ⊕
6 • 7 • 8 • 9 • 10
11 • 12 • 13 • 14 • 15
16 • 17 • 18 • 19 • 21
22 • 24



630 • ⊕
6x7 • 8x9 • 10x11
12x13 • 14x15 • 16x17
18x19 • 21x22



163-141/31 • ⊕, ⊖, ⊕, ⊖



802 • ⊕
0.6x3.5 • 0.8x4 • 1x5.5
1.2x6.5 • 1.2x8 • 1.6x10
2x12



802-PH • ⊕
PH 1 • PH 2 • PH 3



801 NK • ⊕
1x5.5



801 NK-PH • ⊕
PH 2



803-T • ⊕
T 6 • T 7 • T 8 • T 9
T 10 • T 15 • T 20 • T 25
T 27 • T 30



2105 Lg/9 H • ⊕



163-143/18 • ⊕



426 • ⊕
6 • 7



612 N • ⊕
10x11



730
730-3 • 730-6

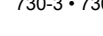

746-1



748 B
748 b-3 • 748 b-4
748 b-5 • 748 b-6
748 b-8



824 • ⊕
0.5x23

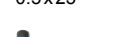

1952-40

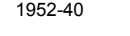

2140-40

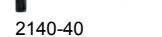

2152 N/3



2154 N-5



4968-2



2128 N-1



2240 N/36
⊕, ⊖, ⊕, ⊖, ⊕, ⊖, ⊕, ⊖



2204 • ⊕
3 • 4 • 5 • 6



2208 • ⊕
0.6x4.5 • 0.8x5.5 • 1x6



2215 • ⊕
PH 1 • PH 2 • PH 3



2216 • ⊕
PZ 1 • PZ 2 • PZ 3



2223 • ⊕
T 10 • T 15 • T 20 • T 25
T 27 • T 30 • T 40



2223 • ⊕
T 20 H • T 30 H



2239-6 • ⊕

HAZET No.	d x š x v mm	81x522x398 mm	166x522x398 mm	kg	□	EAN-No. 4000896+	€
• 5 nízkých a 2 vysoké zásuvky							
179 N-7/220	785x518x1020	5x	2x	90	220	220267	2988,-
179 N-7	785x518x1020	5x	2x	90	-	214488	1273,-
• Sada nářadí							
• Ve vložkách z měkké pěny Safety Insert System							
0-179/220	-	-	-	-	220	168439	1767,-



179 N Dílenský vozík *Assistent*

• Dílenský vozík pro MERCEDES-BENZ

Ⓔ

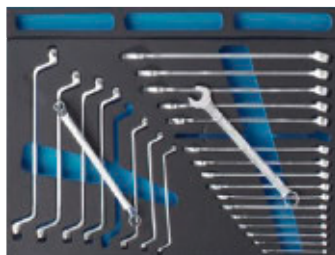
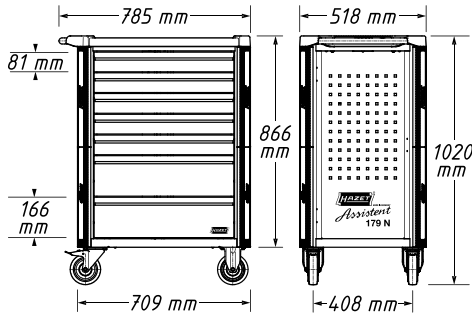
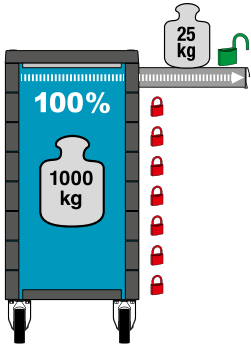
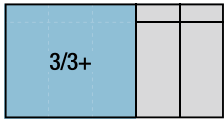

850 • • • 1/4
4 • 5 • 5.5 • 6
7 • 8 • 9 • 10
11 • 12 • 13 • 14

8501 • • • 1/4
3 • 4 • 5 • 6 • 8

8503 • • • 1/4
0.6x3.5 • 1x5.5 • 1.2x8

8506 • • • 1/4
PH 1 • PH 2

8507 • • • 1/4
PZ 1 • PZ 2

863 HP • • 1/4

865 • • 1/4

866 U • • 1/4

867-2 • • 1/4 • • 1/4

868 • • 1/4 • • 1/4

869 • • 1/4 • • 1/4

900 Z • • • 1/2
10 • 11 • 12 • 13 • 14 • 15
16 • 17 • 18 • 19 • 20 • 21
22 • 23 • 24 • 26 • 27 • 28
30 • 32 • 34

915 • • 1/2

916 HP • • 1/2

919 • • 1/2 • • 1/2

919-5 • 919-10

920 • • 1/2 • • 1/2

919-1 • • 1/2 • • 1/2



Provozní a dílenské zařízení

Dílenský vozík *Assistent* se sortimentem



179 N Dílenský vozík *Assistent*

(E)

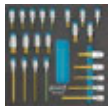

163-119/23 • O, O • 1/2



986 • O • 1/2
5 • 6 • 7 • 8 • 10
12 • 14 • 17 • 19



986 KK • O • 1/2
6 • 7 • 8 • 10



990 • O • 1/2
M 8 • M 10 • M 12
M 14 • M 16 • M 18



990 LG • O • 1/2
M 8 • M 14

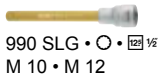

990 SLG • O • 1/2
M 10 • M 12



163-120/24 • O, O, O



730
730-3 • 730-6



746-1



748 B
748 b-3 • 748 b-4
748 b-5 • 748 b-6



760-2



801 NK • O
1x5.5



801 NK-PH • O
PH 2



803 • O
0.4x2.5 • 0.5x3 • 0.6x3.5
0.8x4 • 1.2x6.5 • 1.2x8



803-PH • O
PH 1 • PH 2 • PH 3



1802 M-22



1841 M b-33



1850 M-22



2105 Lg/9 H • O



2140-50



163-121/4

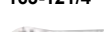

755-10 A



1802 M-33



1803 M-11



1841 M a-11



163-122/3 • O

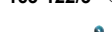

428 • O
8 • 10 • 13



163-124/4



1845 A-19



1845 B-19



1845 C-19

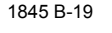

1845 D-19



163-130 L



163-131/8
1/4, 3/8, 1/2, 3/4



858-1 • O • 3/8



8858-1 • 1/2, 3/8, 1/2, 3/8



8858-2 • 1/4, 3/8, 1/2, 3/8



903 SLG • O • 1/2
17 • 19



958-1 • 1/2, 3/8, 1/2, 3/8



958-2 • 1/2, 3/8, 1/2, 3/8



1058-2 • 1/2, 3/8, 1/2, 3/8



163-30/25 • O, O



600 N • O
6 • 7 • 8 • 9 • 10
11 • 12 • 13 • 14 • 15
16 • 17 • 18 • 19 • 21
22 • 24



630 • O
6x7 • 8x9 • 10x11
12x13 • 14x15 • 16x17
18x19 • 21x22



163-522x50



163-53/75 • O, O, O, O
1/2, 3/8, 1/2, 3/8



609 • O
E 6, E 8 • E 10, E 12
E 14, E 18 • E 20, E 24



803-T • O
T 6 • T 7 • T 8 • T 9
T 10 • T 15 • T 20 • T 25
T 27 • T 30



850 E • O • 1/4
E 4 • E 5 • E 6 • E 7 • E 8



880 • O • 1/2, 3/8
10 • 11 • 12 • 13
14 • 15 • 16 • 17
18 • 19 • 21 • 22



880 E • O • 1/2, 3/8
E 10 • E 11 • E 12 • E 14



8802 • O • 1/2, 3/8
T 40 • T 45



8816 HP • 1/2, 3/8



8820 • 1/2, 3/8, 1/2, 3/8



8821 • 1/2, 3/8, 1/2, 3/8



8821-3 • 8821-6 • 8821-10



900 E • O • 1/2, 3/8
E 16 • E 18 • E 20 • E 24



992 • O • 1/2, 3/8
T 50 • T 55 • T 60



2115 • O
T 6 • T 7 • T 8 • T 9
T 10 • T 15 • T 20 • T 25
T 27 • T 30 • T 40



2223 • O • 1/2, 3/8
T 6



2223 • O • 1/2, 3/8
T 7 H • T 8 H • T 9 H
T 10 H • T 15 H • T 20 H
T 25 H • T 27 H • T 30 H
T 40 H



2223 LG • O • 1/2, 3/8
T 25



2250-1 • 1/2, 3/8, 1/2, 3/8



2250-2 • 1/2, 3/8, 1/2, 3/8



863 HP B • 1/2, 3/8



163-95/8 • O



450 N • O
6x7 • 8x9 • 10x11
12x13 • 14x15 • 16x17
18x19 • 21x22



163-97/6 • O

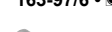

606 • O
8 • 10 • 12 • 13 • 17 • 19

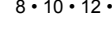

180-38

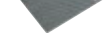

426 • O
6 • 7 • 8



450 N • O
24x27 • 30x32



600 N • O
27 • 30 • 32



612 • O
10x11



630 • O
24x27 • 30x32

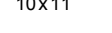

650-20

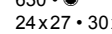

803 LG-T • O
T 15 • T 20 • T 25 • T 30

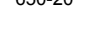

824 • O
0.5x23

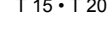

828-T • O
T 45

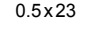

880 G/10 H • O • 1/2, 3/8

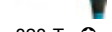

880 G • O • 1/2, 3/8
10 • 11 • 12 • 13 • 14
15 • 16 • 17 • 18 • 19



880 TZ/10 H • O • 1/2, 3/8



880 TZ • O • 1/2, 3/8
10 • 11 • 12 • 13 • 14
15 • 16 • 17 • 18 • 19



900 SZ • O • 1/2, 3/8
32 • 34 • 36

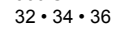

918-23 • 1/2, 3/8, 1/2, 3/8



1015/2 • 1/2, 3/8

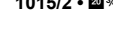

1014



1015-1 • 1/2, 3/8

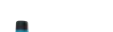

1952-35

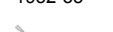

1976



2130



2147

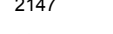

2154-10

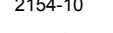

2154 N-5

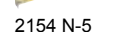

2160

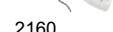

2165-2

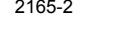

2211 • O • 1/2, 3/8
M 4 • M 5

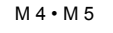

2212 • O • 1/2, 3/8
M 10 • M 6 • M 8

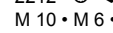

6420 b • 1/2, 3/8, 1/2, 3/8



6420 c • 1/2, 3/8, 1/2, 3/8

HAZET No.	d x š x v mm	81x522x398 mm	166x522x398 mm	kg	EAN-No. 4000896+	€
<ul style="list-style-type: none"> • 7 nízkých zásuvek a 1 vysoká zásuvka • Včetně 296dílné sady nářadí ve vložce z měkké pěny v úložném vkládacím systému 						
179 N-8-2700/296	785x518x1020	7x	1x	90	220298	5533,-
179 N-8	785x518x1020	7x	1x	90	214587	1370,-
<ul style="list-style-type: none"> • Sada nářadí • Ve vložkách z měkké pěny Safety Insert System 						
0-2700-163/296	-	-	-	37	162031	4328,-



179 N Dílenský vozík *Assistent*

• Se sortimentem pro VW / AUDI

Ⓔ

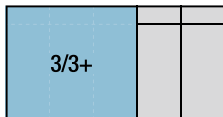

YouTube Clip

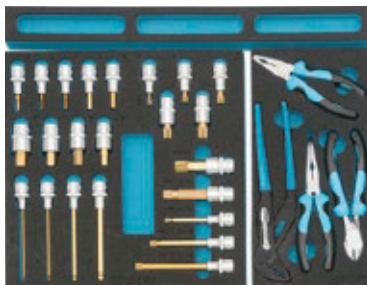
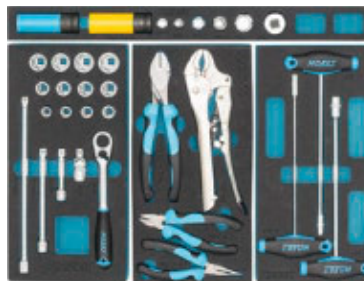
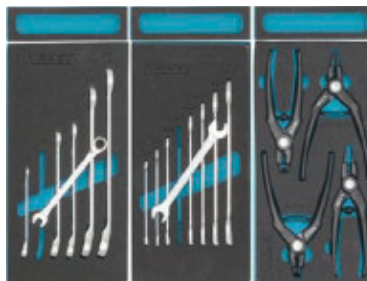
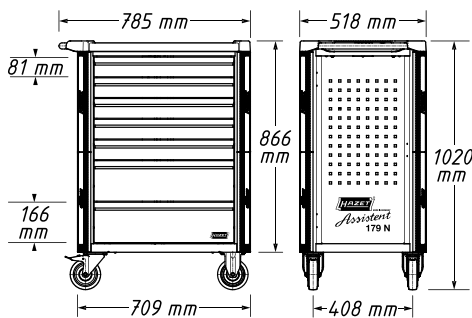
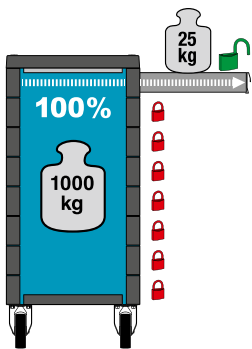



Provozní a dílenské zařízení

Dílenský vozík *Assistent* se sortimentem



179 N Dílenský vozík *Assistent*

(E)



179 N-8-RAL 7021

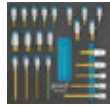

163-119/23 • O, O • 1/2



986 • O • 1/2
5 • 6 • 7 • 8 • 10
12 • 14 • 17 • 19



986 KK • O • 1/2
6 • 7 • 8 • 10



990 • O • 1/2
M 8 • M 10 • M 12
M 14 • M 16 • M 18



990 LG • O • 1/2
M 8 • M 14



990 SLG • O • 1/2
M 10 • M 12



163-121/4



755-10 A



1802 M-33



1803 M-11



1841 M a-11



163-122/3 • O



428 • O
8 • 10 • 13



163-124/4



1845 A-19

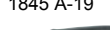

1845 B-19

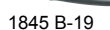

1845 C-19



1845 D-19



163-131/8

1/4, 3/8, 1/2, 3/4



858-1 • 3/8 • 1/2



8858-1 • 1/2 • 3/4

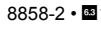

8858-2 • 3/4 • 1/2

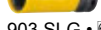

903 SLG • 1/2



958-1 • 3/4 • 1/2

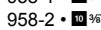

958-2 • 1/2 • 3/4



1058-2 • 1/2 • 3/4



163-141/31 • O, O, O, O

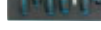

802 • O
0.6x3.5 • 0.8x4 • 1x5.5
1.2x6.5 • 1.2x8 • 1.6x10
2x12



802-PH • O
PH 1 • PH 2 • PH 3



801 NK • O
1x5.5

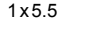

801 NK-PH • O
PH 2

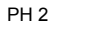

803-T • O
T 6 • T 7 • T 8 • T 9
T 10 • T 15 • T 20 • T 25
T 27 • T 30

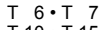

2105 Lg/9 H • O



163-143/18 • O

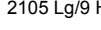

426 • O
6 • 7



612 N • O
10x11



730
730-3 • 730-6



746-1



748 B
748 b-3 • 748 b-4
748 b-5 • 748 b-6
748 b-8



824 • O
0.5x23

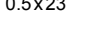

1952-40

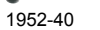

2140-40



2152 N/3



2154 N-5

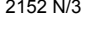

4968-2



163-172x50



163-181/17 • O • 3/8



880 • O • 3/8
10 • 11 • 12 • 13
14 • 15 • 16 • 17
18 • 19 • 21 • 22



8816 HP • O • 3/8

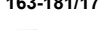

8820 • O • 3/8 • 1/2
10 • 11 • 12 • 13
14 • 15 • 16 • 17
18 • 19 • 21 • 22

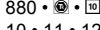

8821 • O • 3/8 • 1/2
8821-3 • 8821-6 • 8821-10



163-257/4



760-2

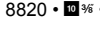

1802 M-22

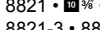

1841 M b-33



1850 M-22

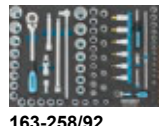

163-258/92



850 • O • 1/4
4 • 5 • 5.5 • 6
7 • 8 • 9 • 10
11 • 12 • 13 • 14

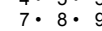

850 E • O • 1/4
E 4 • E 5 • E 6 • E 7 • E 8

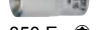

8501 • O • 3/4
3 • 4 • 5 • 6



8502 • O • 3/4
T 10 • T 15 • T 20
T 25 • T 27



8503 • O • 3/4
1x5.5

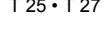

8506 • O • 3/4
PH 1 • PH 2

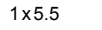

863 HP • O • 1/4

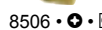

866 U • O • 1/4



867-2 • O • 1/4 • 3/4



867-4 • O • 1/4 • 3/4

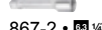

868 • O • 1/4 • 3/4

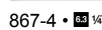

900 • O • 1/2
10 • 11 • 12 • 13 • 14
15 • 16 • 17 • 18 • 19
20 • 21 • 22 • 24 • 27
30 • 32



900 Z • O • 1/2
8 • 9 • 10 • 12 • 13
14 • 15 • 16 • 17 • 18
19 • 21 • 22 • 24 • 27
30 • 32

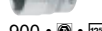

900 E • O • 1/2
E 10 • E 12 • E 14
E 16 • E 18 • E 20

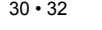

915 • O • 1/2



916 HP • O • 1/2



919 • O • 1/2 • 3/4



920 • O • 1/2 • 3/4



992 • O • 1/2
T 30 • T 40 • T 45
T 50 • T 55 • T 60

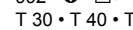

2223 • O • 3/8
T 6 • T 7 • T 8 • T 9



2250-1 • O • 1/4



163-30/25 • O • O

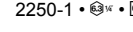

600 N • O
6 • 7 • 8 • 9 • 10
11 • 12 • 13 • 14 • 15
16 • 17 • 18 • 19 • 21
22 • 24



630 • O
6x7 • 8x9 • 10x11
12x13 • 14x15 • 16x17
18x19 • 21x22



163-522x50

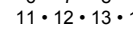

163-95/8 • O

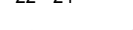

450 N • O
6x7 • 8x9 • 10x11
12x13 • 14x15 • 16x17
18x19 • 21x22

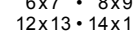

163-97/6 • O



606 • O
8 • 10 • 12 • 13 • 17 • 19



426 • O
8

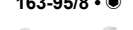

450 N • O
24x27 • 30x32

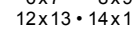

600 N • O
27 • 30 • 32



630 • O
24x27 • 30x32



650-20



803 LG-T • O
T 15 • T 20 • T 25 • T 30



828-T • O
T 45



880 G/10 H • O • 3/8



880 G • O • 3/8
10 • 11 • 12 • 13 • 14
15 • 16 • 17 • 18 • 19



880 TZ/10 H • O • 3/8



880 TZ • O • 3/8
10 • 11 • 12 • 13 • 14
15 • 16 • 17 • 18 • 19



882-1 • O • 3/8 • 1/2



882-10 • O • 3/8 • 1/2



882-2 • O • 3/8 • 1/2



882-3 • O • 3/8 • 1/2



900 SZ • O • 1/2
32 • 36



918-23 • O • 1/2 • 3/4



1015/2 • O • 3/4



1014



1015-1 • O • 3/4



1841 M a-22



2116 Lg/8 H • O



2211 • O • 3/8
M 4 • M 5



2212 • O • 3/8
M 10 • M 6 • M 8



6420 b • O • 1/4



6420 c • O • 1/4

HAZET No.	d x š x v mm					EAN-No. 4000896+	€
• 7 nízkých zásuvek a 1 vysoká zásuvka							
• Barva RAL 7021 (černošedá)							
• Včetně 300dílné sady náradí ve vložce z měkké pěny v úložném vkládacím systému							
179 N-8-RAL 7021/300	785x518x1020	7x	1x	90	300	220328	5790,-
179 N-8-RAL 7021	785x518x1020	7x	1x	90	-	220311	1370,-



0-2500 Standardní sortiment pro AUDI

• Standardní sortiment pro AUDI

• Safety-Insert-System, 2komponentní vložka z měkké pěny.
Vložka vhodná také pro HAZET-Assistent



163-30/25 • ●, ●



600 N • ●

6 • 7 • 8 • 9 • 10
11 • 12 • 13 • 14 • 15
16 • 17 • 18 • 19 • 21
22 • 24



630 • ●
6x7 • 8x9 • 10x11
12x13 • 14x15 • 16x17
18x19 • 21x22



163-97/6 • ●



606 • ●
8 • 10 • 12 • 13 • 17 • 19

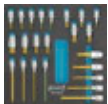

163-119/23 • ○, ○, □ 1/2



986 • ○, □ 1/2
5 • 6 • 7 • 8 • 10
12 • 14 • 17 • 19



986 KK • ○, □ 1/2
6 • 7 • 8 • 10



990 • ○, □ 1/2
M 8 • M 10 • M 12
M 14 • M 16 • M 18



990 LG • ○, □ 1/2
M 8 • M 14



990 SLG • ○, □ 1/2
M 10 • M 12



163-141/31 • ●, ○, ●, ●



802 • ●
0.6x3.5 • 0.8x4 • 1x5.5
1.2x6.5 • 1.2x8 • 1.6x10
2x12



802-PH • ●
PH 1 • PH 2 • PH 3



801 NK • ●
1x5.5



801 NK-PH • ●
PH 2



803-T • ○
T 6 • T 7 • T 8 • T 9
T 10 • T 15 • T 20 • T 25
T 27 • T 30



2105 Lg/9 H • ○



163-143/18 • ●



426 • ●
6 • 7



612 N • ●
10x11



730
730-3 • 730-6



746-1



748 B
748 b-3 • 748 b-4
748 b-5 • 748 b-6
748 b-8



824 • -
0.5x23



1952-40



2140-40



2152 N/3

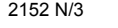

2154 N-5



4968-2



163-172x50



163-257/4



760-2



1802 M-22

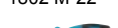

1841 M b-33



1850 M-22

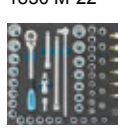

163-258/92



850 • ●, □ 1/4
4 • 5 • 5.5 • 6
7 • 8 • 9 • 10
11 • 12 • 13 • 14



850 E • ●, □ 1/4
E 4 • E 5 • E 6 • E 7 • E 8



8501 • ○, □ 1/4
3 • 4 • 5 • 6



8502 • ○, □ 1/4
T 10 • T 15 • T 20
T 25 • T 27



8503 • ●, □ 1/4
1x5.5



8506 • ●, □ 1/4
PH 1 • PH 2



863 HP • ●, □ 1/4



866 U • ●, □ 1/4



867-2 • ●, □ 1/4 • □ 1/4

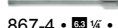

867-4 • ●, □ 1/4 • □ 1/4



868 • ●, □ 1/4 • □ 1/4

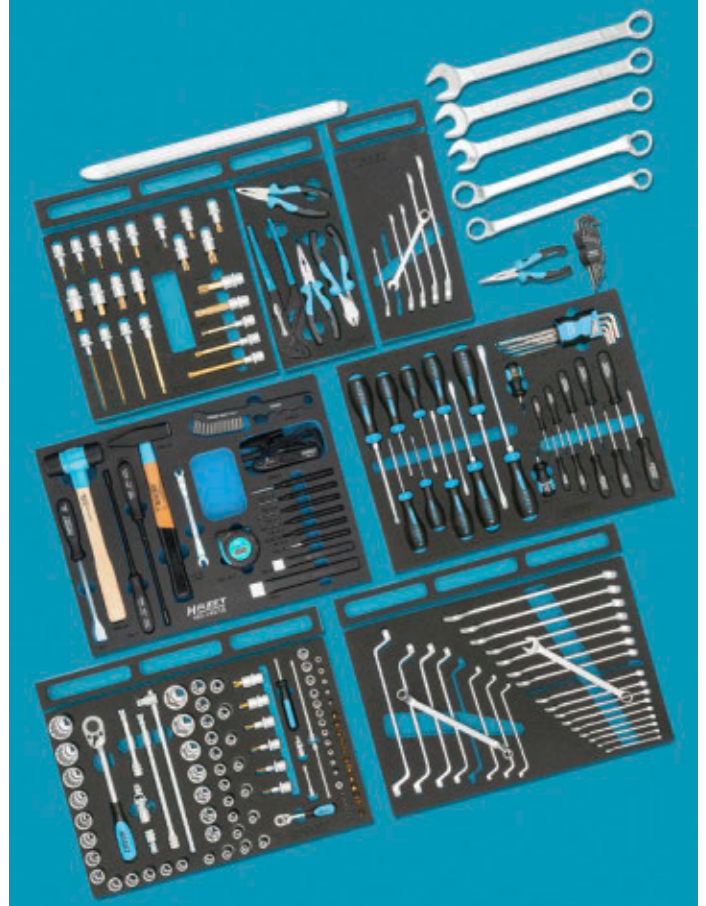

869 • ●, □ 1/4 • □ 1/4



900 • ●, □ 1/2



10 • 11 • 12 • 13 • 14



15 • 16 • 17 • 18 • 19



20 • 21 • 22 • 24 • 27



30 • 32



900 Z • ●, □ 1/2



8 • 9 • 10 • 12 • 13



14 • 15 • 16 • 17 • 18



19 • 21 • 22 • 24 • 27



30 • 32



900 E • ●, □ 1/2



E 10 • E 12 • E 14



915 • ●, □ 1/2



916 HP • ●, □ 1/2

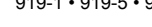

919 • ●, □ 1/2 • □ 1/2

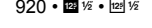

919-1 • 919-5 • 919-10



920 • ●, □ 1/2 • □ 1/2



992 • ●, □ 1/2

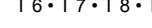

T 30 • T 40 • T 45

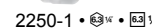

T 50 • T 55 • T 60



2223 • ●, □ 1/4



T 6 • T 7 • T 8 • T 9



2250-1 • ●, □ 1/4 • □ 1/4



163-522x50



600 N • ●



27 • 30 • 32



630 • ●



24x27 • 30x32



650-20



1841 M a-22



2116 Lg/8 H • ○



Provozní a dílenské zařízení

Dílenský vozík *Assistent* se sortimentem



0-2500 Doplnkový sortiment pro AUDI

Doplnkový sortiment pro AUDI

- Safety-Insert-System, 2komponentní vložka z měkké pěny.
- Vložka vhodná také pro HAZET-Assistent



163-95/8 • ●



450 N • ●
6x7 • 8x9 • 10x11
12x13 • 14x15 • 16x17
18x19 • 21x22



163-121/4



755-10 A



1802 M-33



1803 M-11



1841 M a-11



163-122/3 • ●



428 • ●

8 • 10 • 13



163-124/4



1845 A-19



1845 B-19



1845 C-19



1845 D-19



163-131/8

63 3/4, 10 3/8, 12 1/2, 20 3/4



858-1 • 10 3/8 • 63 1/4



8858-1 • 12 1/2 • 10 3/8

8858-2 • 63 1/4 • 10 3/8



903 SLG • 12 1/2 • 17 • 19



958-1 • 20 3/4 • 12 1/2

958-2 • 10 3/8 • 12 1/2



1058-2 • 12 1/2 • 20 3/4



163-172x50



163-181/17 • ● • 10 3/8



880 • ● • 10 3/8

10 • 11 • 12 • 13

14 • 15 • 16 • 17

18 • 19 • 21 • 22



8816 HP • 10 3/8



8820 • 10 3/8 • 10 3/8



8821 • 10 3/8 • 10 3/8

8821-3 • 8821-6 • 8821-10



426 • ●

8



450 N • ●

24x27 • 30x32



803 LG-T • ○

T 15 • T 20 • T 25 • T 30



828-T • ○

T 45



880 G/10 H • ● • 10 3/8



880 G • ● • 10 3/8

10 • 11 • 12 • 13 • 14

15 • 16 • 17 • 18 • 19



880 TZ/10 H • ● • 10 3/8



880 TZ • ● • 10 3/8

10 • 11 • 12 • 13 • 14

15 • 16 • 17 • 18 • 19



8822-1 • 10 3/8 • 10 3/8



8822-10 • 10 3/8 • 10 3/8



8822-3 • 10 3/8 • 10 3/8



900 SZ • ● • 12 1/2

32 • 36

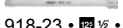

918-23 • 12 1/2 • 12 1/2



1015/2 • 20 3/4



1014



1015-1 • 20 3/4



2211 • ○ • 10 3/8

M 4 • M 5

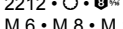

2212 • ○ • 10 3/8

M 6 • M 8 • M 10

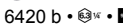

6420 b • ● • 10 3/8



6420 c • ● • 10 3/8

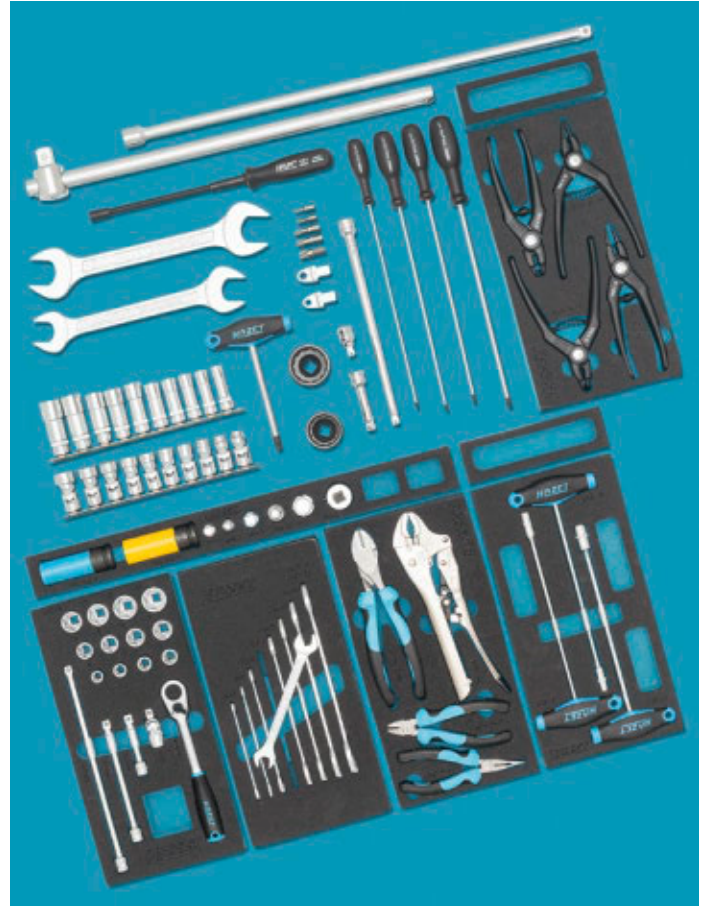

HAZET No. 0-2500-163/86

12 kg

86

EAN-No. 4000896+ € 179503 1636,-



179 N Dílenský vozík *Assistant*

• Kompletní sortiment pro osobní automobily BMW

Ⓔ

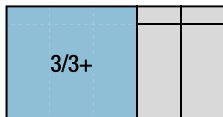

YouTube Clip

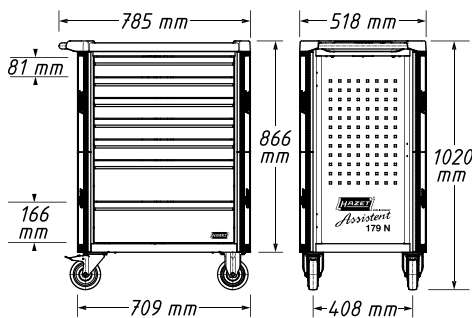
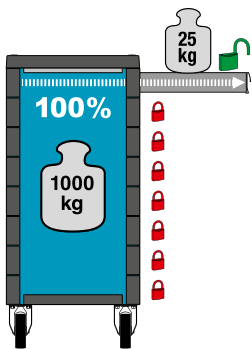

© BMW AG

**Přizpůsobená sada nářadí
– doporučeno BMW –**

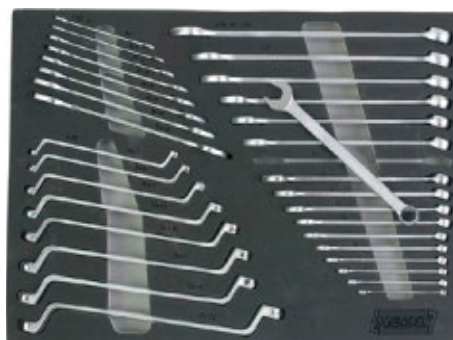



179 N Dílenský vozík *Assistant*

- Vyvinuto s předními výrobci automobilů
- Opracování hliníkových dílů karoserií speciálními nástroji, např. na čistě hliníkových karoseriích a hliníkových součástech hybridních karoserií
- Červené označení nástrojů signalizuje uživateli speciální použití na pracovištích s hliníkem nebo smíšenými materiály

Ⓔ

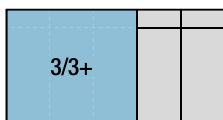

YouTube Clip

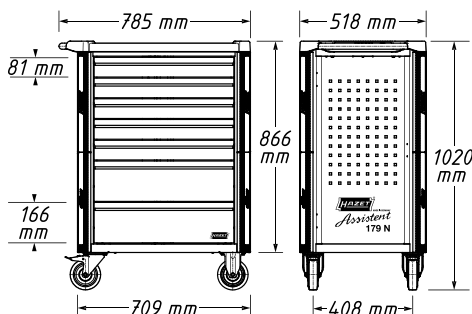
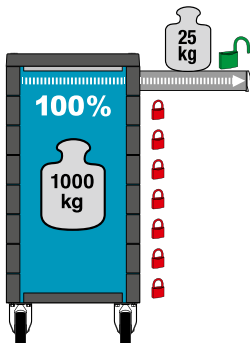



Provozní a dílenské zařízení

Dílenský vozík *Assistent* se sortimentem



179 N Dílenský vozík *Assistent*

(E)



179 N X-7-RAL 3020



179 N
161 T-179 N/4



180-38



750/6-1-RAL 3002



752-1 RAL 3002



752-2 RAL 3002



753-10 S RAL 3002



754-10 RAL 3002



757-12 RAL 3002



757-7 RAL 3002



758-2 RAL 3002



758-5 RAL 3002



759 N-2 RAL 3002



799-3 RAL 3002



822 RAL 3002



1774-250



1810-250 RAL 3002



1850-22 RAL 3002



1917 N



1919 N



1911-1923
1920 N RAL 3002



1911-1923
1921



1924-3 RAL 3002



1924-5 RAL 3002



1924-7 RAL 3002



1928 K RAL 3002



1927-1930
1930-1 RAL 3002



1931 RAL 3002



1933 RAL 3002



1934-1

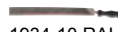

1934-10 RAL 3002

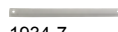

1934-7



1934-9 RAL 3002



1934 N-1 RAL 3002



1934 N-2 RAL 3002



1938 K-RAL 3002



1935-1950
1940 RAL 3002



1935-1950
1950 RAL 3002



1952-23 RAL 3002



1952-28 RAL 3002



1952-35 RAL 3002



1953 N-30 RAL 3002



1953 N-45 RAL 3002



1953 N-60 RAL 3002



1960-5 RAL 3002



1961 L-2



1961 R-2



1964-30 RAL 3002



1975



1976



2130-1 RAL 3002

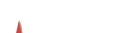

2140-3 RAL 3002



2140-5 RAL 3002



2141-0 RAL 3002



2150

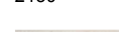

2154-500



2154 N-5

HAZET No.	d x š x v mm	81x522x398 mm	166x522x398 mm	l mm	kg		EAN-No. 4000896+	€
<ul style="list-style-type: none"> Dílenské vozíky 179 N X-7-RAL 3020: 5 nízkých a 2 vysoké zásuvky Komplet s 65dílným nářadím na hliníkové karoserie Opracovávání hliníkových dílů karoserií speciálními nástroji, např. na čistě hliníkových karoseriích a hliníkových součástech hybridních karoserií Pro např. AUDI Q7 r.v. 2015 → · A2 (částečně) · A6 r.v. 2011 → · A8 · R8 · TT BMW řada 5 řada 6 · Z8 LAND ROVER Defender MITSUBISHI i-MiEV r.v. 2009 → 2016 PORSCHE Cayenne r.v. 2018 → VW Touareg r.v. 2018 → Červené označení nástrojů signalizuje uživateli speciální použití na pracovištích s hliníkem nebo smíšenými materiály 								
179 N X-7/65 ALU	786x518x1020	5x	2x	786	90	65	219117	4712,-
179 N X-7-RAL 3020	786x518x1020	5x	2x	786	90	-	219322	1333,-
<ul style="list-style-type: none"> Sada nástrojů na hliníkové karoserie Opracovávání hliníkových dílů karoserií speciálními nástroji, např. na čistě hliníkových karoseriích a hliníkových součástech hybridních karoserií Pro např. AUDI Q7 r.v. 2015 → · A2 (částečně) · A6 r.v. 2011 → · A8 · R8 · TT BMW řada 5 řada 6 · Z8 LAND ROVER Defender MITSUBISHI i-MiEV r.v. 2009 → 2016 PORSCHE Cayenne r.v. 2018 → VW Touareg r.v. 2018 → Červené označení nástrojů signalizuje uživateli speciální použití na pracovištích s hliníkem nebo smíšenými materiály 								
0-179 N X/65 ALU	-	-	-	-	-	65	219124	3452,-



179 NXL Dílenský vozík *Assistent*

• Vozíky na nářadí, na materiál a montážní vozíky

Ⓔ

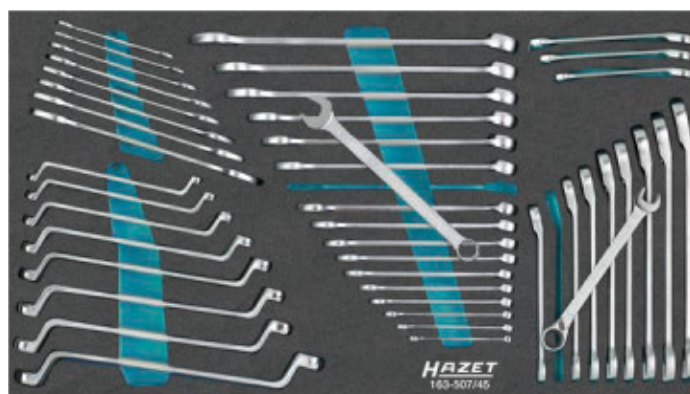
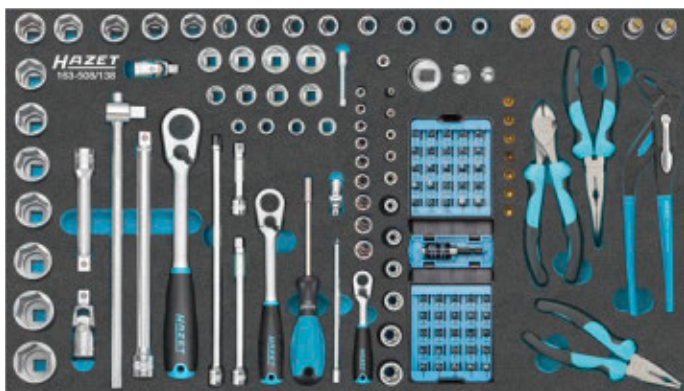
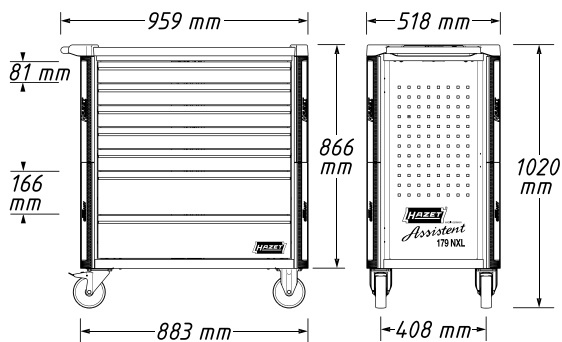
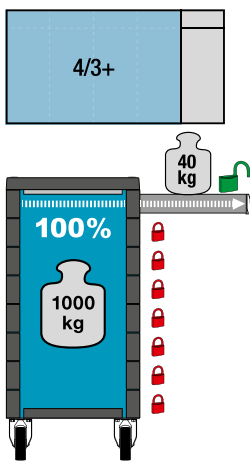



Provozní a dílenské zařízení

Dílenský vozík *Assistent* se sortimentem



179 NXL Dílenský vozík *Assistent*



179 N XL-7



163-480/57 •

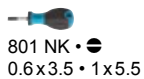

801 NK •

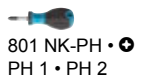

801 NK-PH •

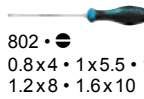

802 •

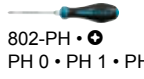

802-PH •



805/7 •



808/7 •



810 •

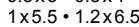

810-PH •

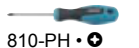

810-T •



810-T •

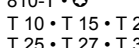

810-T •



839 •



2105 Lg/9 H •

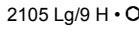

2116 Lg/8 H •

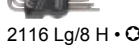

163-507/45 •

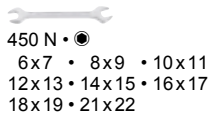

450 N •



600 N •

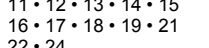

606 •



630 •

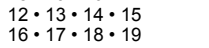

163-508/138 •



760-2 •

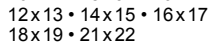

810 SPC-6.3 •



850 •



850 E •

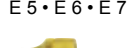

8502 •

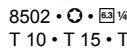

863 HP •



867-2 •



868 •



869 •



880 •



8816 HP •



8820 •

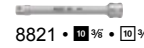

8821-3 •



8858-2 •



900 •

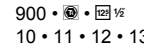

900 E •

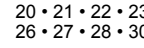

915 •



916 HP •

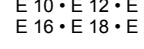

917-5 •



918-10 •

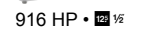

920 •



958-2 •

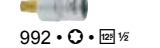

992 •

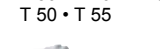

1058-2 •



1802 M-22 •

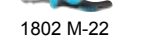

1841 M b-33 •

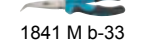

1850 M-22 •

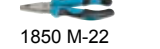

2240 N/51 •



2250-1 •



2128 N-1 •

HAZET No.	d x š x v mm	81x696x398 mm	166x696x398 mm	kg		EAN-No. 4000896+	€
<ul style="list-style-type: none"> • 5 nízkých a 2 vysoké zásuvky • Kompletní s 265dílnou sadou nářadí ve vložce z měkké pěny v úložném vkládacím systému 							
179 N XL-7/265	959x518x1020	5x	2x	125	265	215201	3995,-
179 N XL-7	959x518x1020	5x	2x	125	-	215164	2076,-
<ul style="list-style-type: none"> • Sada nářadí • Ve vložkách z měkké pěny Safety Insert System 							
0-179 N XL/265	-	-	-	-	265	214761	2112,-



179 NXL Dílenský vozík *Assistant*

• Vozíky na nářadí, na materiál a montážní vozíky

Ⓔ

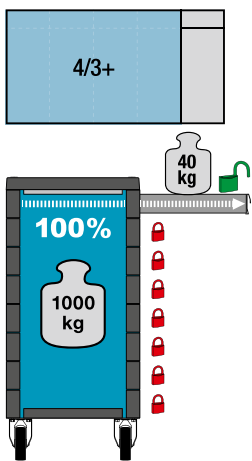

YouTube Clip

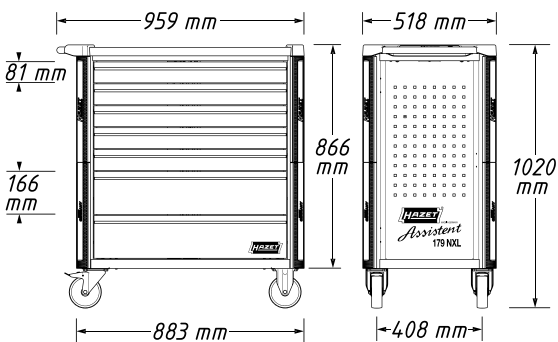



Provozní a dílenské zařízení

Dílenský vozík *Assistent* se sortimentem



179 NXL Dílenský vozík *Assistent*



179 N XL-8



163-478/40

450 N

6x7 • 8x9 • 10x11
12x13 • 14x15 • 16x18
17x19 • 21x22 • 22x24
24x27 • 30x32 • 34x36

600 N

8 • 9 • 10 • 11 • 12
13 • 14 • 15 • 16 • 17
18 • 19 • 21 • 22 • 24
27 • 30 • 32 • 34

630

6x7 • 8x9 • 10x11
12x13 • 14x15 • 16x17
18x19 • 21x22 • 24x27



163-479/26

730

730-3 • 730-7

740-3

746-2

748 B

748 b-2 • 748 b-3
748 b-4 • 748 b-5
748 b-6 • 748 b-8



751 HS/5

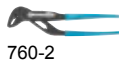

760-2

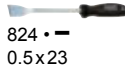

824
0.5x23



1802-33

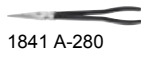

1841 A-280

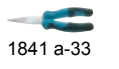

1841 a-33

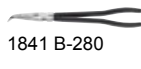

1841 B-280



1841 b-33



1850-33



1953 N-40



2140-50



2142-2



163-480/57

801 NK

0.6x3.5 • 1x5.5

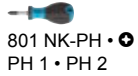

801 NK-PH
PH 1 • PH 2

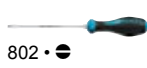

802
0.8x4 • 1x5.5 • 1.2x6.5
1.2x8 • 1.6x10

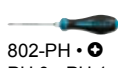

802-PH
PH 0 • PH 1 • PH 2 • PH 3



805/7



808/7

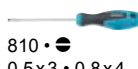

810
0.5x3 • 0.8x4
1x5.5 • 1.2x6.5

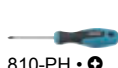

810-PH
PH 1 • PH 2



810-T
T 10 • T 15 • T 20
T 25 • T 27 • T 30

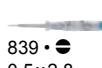

839
0.5x2.8



2105 Lg/9 H



2116 Lg/8 H



163-481/194



810 SPC-6.3



850
3 • 4 • 5 • 6
7 • 8 • 9 • 10
11 • 12 • 13 • 14



850 E
E 4 • E 5 • E 6 • E 8 • E 10

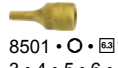

8501
3 • 4 • 5 • 6 • 8

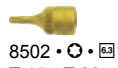

8502
T 15 • T 20 • T 25
T 27 • T 30 • T 40



8503
0.6x3.5 • 1x5.5 • 1.2x8



8506
PH 1 • PH 2



8507
PZ 1 • PZ 2



850 LG
4 • 5 • 6 • 7 • 8
9 • 10 • 11 • 12 • 13



858-1

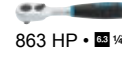

863 HP

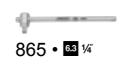

865



866 U

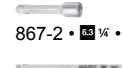

867-2

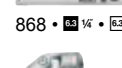

868



869



880

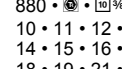

8801 K



880 LG

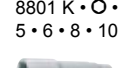

8816 HP

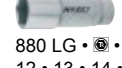

8820

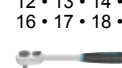

8821

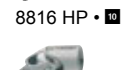

8821-3 • 8821-6 • 8821-10



900

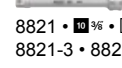

915



916 HP

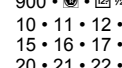

917-5

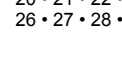

918-10



920



986



990



991



992



2240 N/51



2250-1

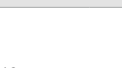

179-35

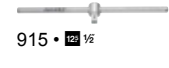

915

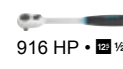

916 HP

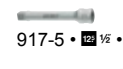

917-5



918-10



920

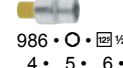

986

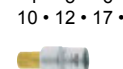

990

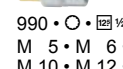

991

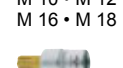

992

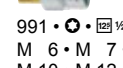

2240 N/51



2250-1

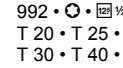

179-35

HAZET No.	d x š x v mm	81x696x398 mm	166x696x398 mm	kg		EAN-No. 4000896+	€
<ul style="list-style-type: none"> • 7 nízkých zásuvek a 1 vysoká zásuvka • Kompletní s 317dílnou sadou nářadí ve vložce z měkké pěny v úložném vkládacím systému 							
179 N XL-8/317	959x518x1020	7x	1x	125	317	220304	4655,-
179 N XL-8	959x518x1020	7x	1x	125	-	215218	2172,-
<ul style="list-style-type: none"> • Sada nářadí • Ve vložkách z měkké pěny Safety Insert System 							
0-179 XL/317	-	-	-	-	317	208302	3046,-



179 NXL Dílenský vozík *Assistant*

- Sada VW / AUDI
- Doplnkový sortiment viz také:
 - Doplnkový sortiment pro AUDI 0-2500-163/72
 - Doplnkový sortiment pro VW 0-2500-163/73
 - Doplnková sada pro karoserie 163-381/9

Ⓔ

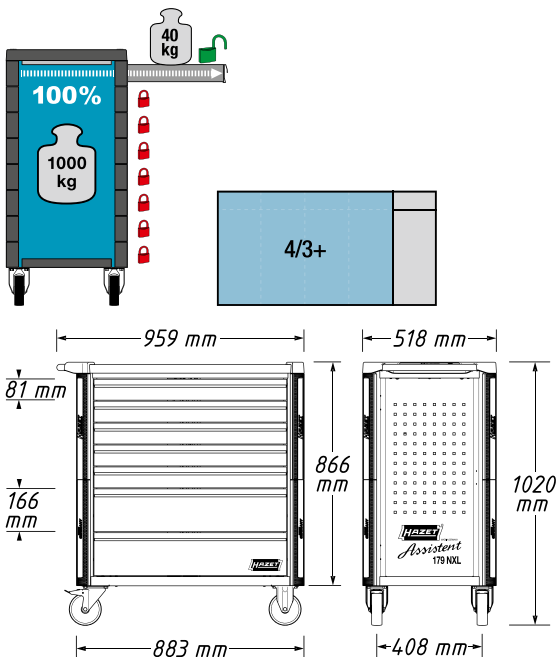

YouTube Clip

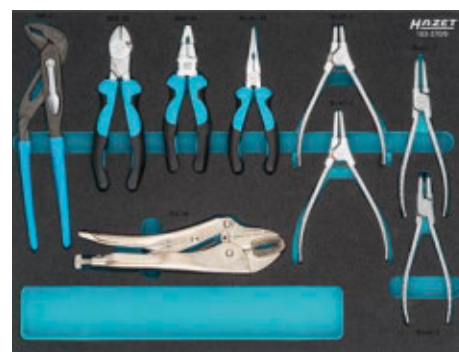
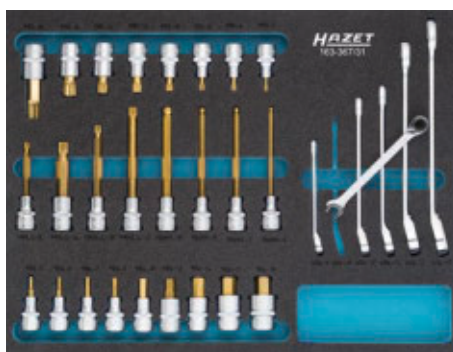
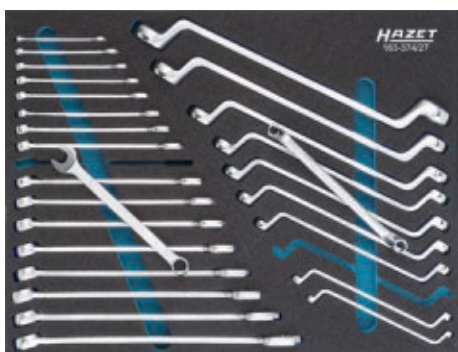



179 NXXL Dílenský vozík *Assistant*

• Vozíky na nářadí, na materiál a montážní vozíky

Ⓔ

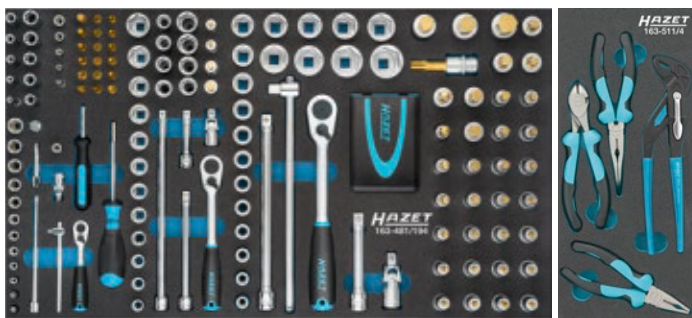
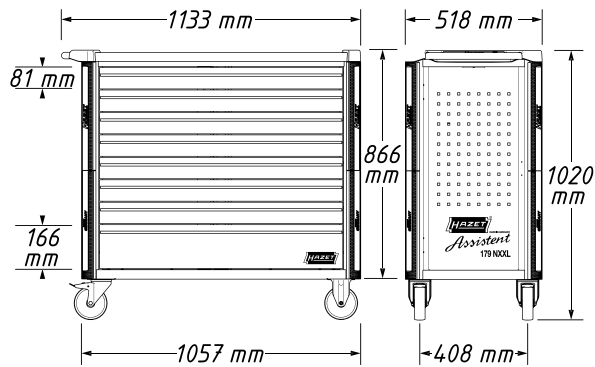
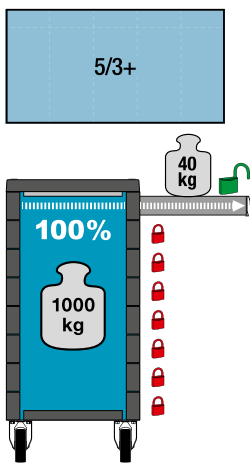



Provozní a dílenské zařízení

Dílenský vozík *Assistent* se sortimentem



179 NXXL Dílenský vozík *Assistent*

(E)



179 N XXL-7



163-478/40

450 N
6x7 • 8x9 • 10x11
12x13 • 14x15 • 16x18
17x19 • 21x22 • 22x24
24x27 • 30x32 • 34x36

600 N
8 • 9 • 10 • 11 • 12
13 • 14 • 15 • 16 • 17
18 • 19 • 21 • 22 • 24
27 • 30 • 32 • 34

630
6x7 • 8x9 • 10x11
12x13 • 14x15 • 16x17
18x19 • 21x22 • 24x27



163-480/57

801 NK
0.6x3.5 • 1x5.5

801 NK-PH
PH 1 • PH 2

802
0.8x4 • 1x5.5 • 1.2x6.5
1.2x8 • 1.6x10

802-PH
PH 0 • PH 1 • PH 2 • PH 3

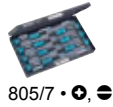

805/7



808/7

810
0.5x3 • 0.8x4
1x5.5 • 1.2x6.5

810-PH
PH 1 • PH 2

810-T
T 10 • T 15 • T 20
T 25 • T 27 • T 30

839
0.5x2.8

2105 Lg/9 H

2116 Lg/8 H



163-481/194

810 SPC-6.3

850
3 • 4 • 5 • 6
7 • 8 • 9 • 10
11 • 12 • 13 • 14

850 E
E 4 • E 5 • E 6 • E 8 • E 10

8501
3 • 4 • 5 • 6 • 8

8502
T 15 • T 20 • T 25
T 27 • T 30 • T 40

8503
0.6x3.5 • 1x5.5 • 1.2x8

8506
PH 1 • PH 2

8507
PZ 1 • PZ 2

850 LG
4 • 5 • 6 • 7 • 8
9 • 10 • 11 • 12 • 13

858-1

863 HP

865

866 U

867-2

868

869

880
10 • 11 • 12 • 13
14 • 15 • 16 • 17
18 • 19 • 21 • 22

8801 K
5 • 6 • 8 • 10

880 LG
12 • 13 • 14 • 15
16 • 17 • 18 • 19

8816 HP

8820

8821
8821-3 • 8821-6 • 8821-10

900
10 • 11 • 12 • 13 • 14
15 • 16 • 17 • 18 • 19
20 • 21 • 22 • 23 • 24
26 • 27 • 28 • 30 • 32

915

916 HP

917-5

918-10

920

986
4 • 5 • 6 • 7 • 8 • 9
10 • 12 • 17 • 19 • 22

990
M 5 • M 6 • M 8
M 10 • M 12 • M 14
M 16 • M 18

991
M 6 • M 7 • M 8 • M 9
M 10 • M 12 • M 14

992
T 20 • T 25 • T 27
T 30 • T 40 • T 45
T 50 • T 55 • T 60

2240 N/51
2250-1

2250-1



163-509/12

606
8 • 9 • 10 • 11
12 • 13 • 14 • 15
16 • 17 • 18 • 19



163-510/8

730
730-3 • 730-6

751 HS/5

2140-50



163-511/4

760-2

1802 M-22

1841 M b-33

1850 M-22



2128 N-1

HAZET No.	d x š x v mm	81 x 870 x 398 mm	166 x 870 x 398 mm	kg		EAN-No. 4000896+	€
<ul style="list-style-type: none"> • 5 nízkých a 2 vysoké zásuvky • Kompletní s 340dílnou sadou nářadí ve vložce z měkké pěny v úložném vkládacím systému 							
179 N XXL-7/340	1133x518x1020	5x	2x	145	340	215072	5066,-
179 N XXL-7	1133x518x1020	5x	2x	145	-	214624	2553,-
• Sada nářadí							
• Ve vložkách z měkké pěny Safety Insert System							
0-179 N XXL/340	-	-	-	-	340	214754	3009,-



Dílenský stůl *Assistent* se sortimentem

177 W Pojízdný dílenský stůl s náradím

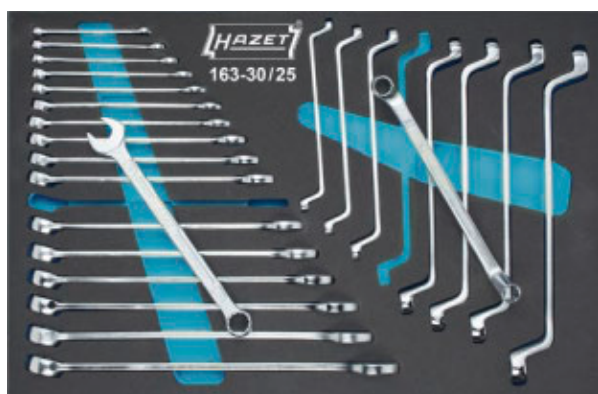
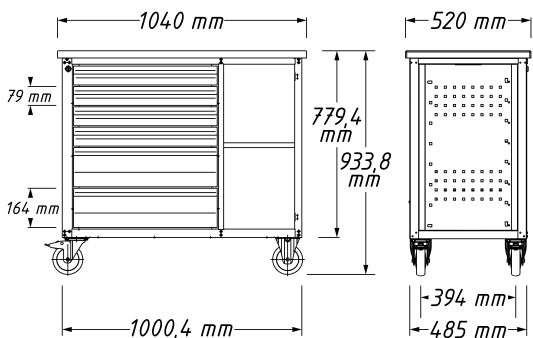
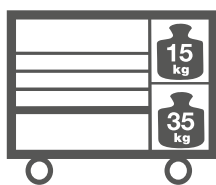
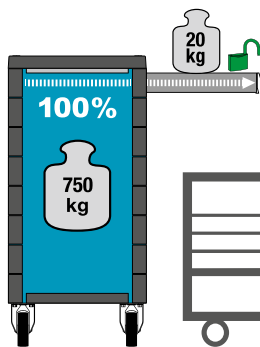
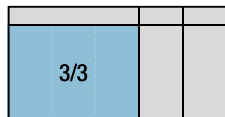



Provozní a dílenské zařízení

Dílenský stůl *Assistent* se sortimentem



177 W Pojízdný dílenský stůl s nářadím



177 W-7



163-30/25 • 6, 8



600 N • 6 • 7 • 8 • 9 • 10 • 11 • 12 • 13 • 14 • 15 • 16 • 17 • 18 • 19 • 21 • 22 • 24



630 • 6x7 • 8x9 • 10x11 • 12x13 • 14x15 • 16x17 • 18x19 • 21x22



163-31/27 • 10, 12, 14

730
730-3 • 730-6

746-1

748 B
748 b-3 • 748 b-4
748 b-5 • 748 b-6

760-2

801 NK • 1x5.5

801 NK-PH • PH 2

803 • 0.4x2.5 • 0.5x3 • 0.6x3.5
0.8x4 • 1.2x6.5 • 1.2x8

803-PH • PH 1 • PH 2

803-T • T 10 • T 15 • T 20
T 25 • T 30

1802 M-22

1841 M b-33

1850 M-22

2140-50



163-57/56 • 10, 12, 14, 16, 18, 20, 22, 24, 26, 28, 30, 32, 34, 36, 38, 40, 42, 44, 46, 48, 50

850 • 4 • 5 • 5.5 • 6
7 • 8 • 9 • 10
11 • 12 • 13 • 14

8501 • 3 • 4 • 5 • 6 • 8

8503 • 0.6x3.5 • 1x5.5 • 1.2x8

8506 • PH 1 • PH 2

8507 • PZ 1 • PZ 2

863 HP

865

866 U

867-2

868

869

900 • 10 • 11 • 12 • 13 • 14 • 15
16 • 17 • 18 • 19 • 20 • 21
22 • 23 • 24 • 26 • 27 • 28
30 • 32 • 34

915

916 HP

917-5

918-10

920

2128 N-1



2240 N/36 • 3 • 4 • 5 • 6

2204 • 3 • 4 • 5 • 6

2208 • 0.6x4.5 • 0.8x5.5 • 1x6

2215 • PH 1 • PH 2 • PH 3

2216 • PZ 1 • PZ 2 • PZ 3

2223 • T 10 • T 15 • T 20 • T 25
T 27 • T 30 • T 40

2223 • T 20 H • T 30 H

2239-6

HAZET No.	d x š x v mm	79x527x348 mm	164x527x348 mm	kg	EAN-No. 4000896+	€
<ul style="list-style-type: none"> • 6x nízká zásuvka a 1x vysoká zásuvka, navíc 2 odkládací plochy v regálové části • Kompletní s 169dílnou sadou nářadí ve vložce z měkké pěny v úložném vkládacím systému 						
177 W-7/169	1040x520x934	6x	1x	7x	85	169
177 W-7	1040x520x934	6x	1x	7x	85	-
<ul style="list-style-type: none"> • Sada nářadí • Ve vložkách z měkké pěny Safety Insert System 						
0-178/169	-	-	-	-	-	169
						157310
						2265,-
						155644
						1197,-
						162208
						1261,-



179 NW Pojízdný pracovní stůl

• Větší odkládací prostor než předchozí model

Ⓔ

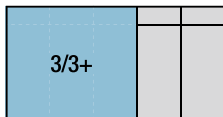

YouTube Clip

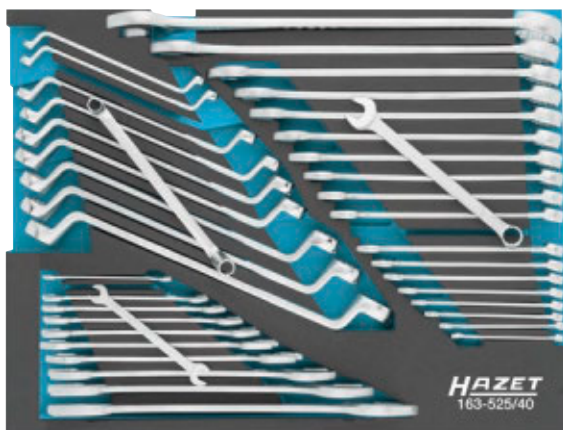
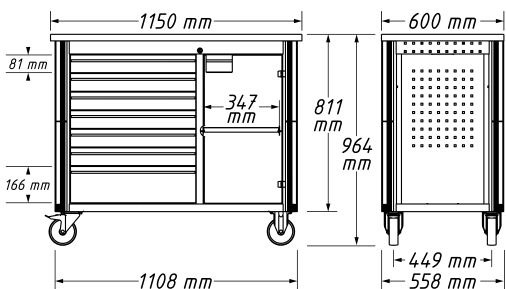
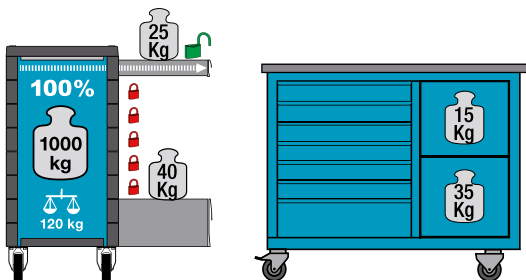



Nástrojový kufřík

190 Kovová skříňka na nářadí se sadou nářadí

- Skříňka na nářadí 190 L kompletní s nářadím a visacím zámekem
- 5dílná sada s visacím zámekem
- Stabilní provedení v modročerném designu
- HAZET modrý / černý vypalovaný lak

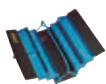
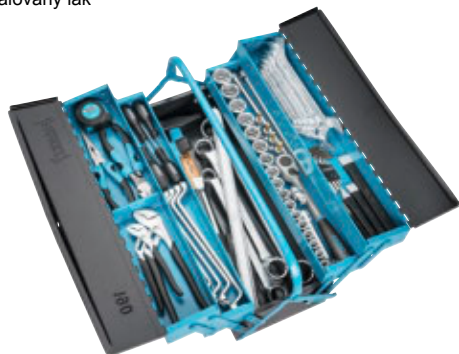

190 L

450 N • ●
6x7 • 8x9 • 10x11
12x13 • 14x15 • 16x17
18x19 • 21x22 • 24x27
30x32

630 • ●
6x7 • 8x9 • 10x11
12x13 • 14x15 • 16x17
18x19 • 21x22 • 24x27
30x32 • 36x41

650-20

730
730-3 • 730-6

740-3

745 A
745 a-2 • 745 a-4

746-2



760 N
760 N-1 • 760 N-2



803 • ●
0.4x2.5 • 0.5x3 • 0.6x3.5
0.8x4 • 1x5.5 • 1.2x8



803-PH • ●
PH 1 • PH 2 • PH 3



803-PZ • ●
PZ 1 • PZ 2



824 • -
0.5x23



900 • ● • □ ½
10 • 11 • 12 • 13 • 14
15 • 16 • 17 • 18 • 19
21 • 22 • 24 • 26 • 27
28 • 30 • 32



915 • □ ½



916 HP • □ ½



917-5 • □ ½ • □ ½



918-10 • □ ½ • □ ½



920 • □ ½ • □ ½



986 • ● • □ ½
5 • 6 • 8 • 10

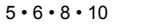

1802 M-22

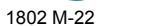

1841 M a-33



1952-35



2100/6 H • ○



2140-50

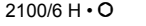

2154 N-3

HAZET
No.

d x š x v
mm



EAN-No.
4000896+

€

190/80 575x210x245 80 048922 1239,-

1520 Kožená brašna na nářadí

- Odolná Micro kůže se superměkkým, vodu odpuzujícím povrchem
- Logo HAZET – velmi kvalitně vyražené



1520 Kožená brašna na nářadí



600 N • ●
8 • 10 • 11 • 12
13 • 15 • 17 • 19



760-2



839 • ●
0.5x2.8



850 • ● • □ ¼
5.5 • 7 • 8 • 10
11 • 12 • 13



863 HP • □ ¼



866 U • □ ¼



867-4 • □ ¼ • □ ¼



1803 M-11

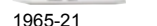

1965-21



1979 N-71



1987 N-4



2140-20

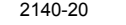

2240 N/36
●, ●, ●, ●, ●, ●, ●, ●, ●, ●



2250-1 • □ ¼ • □ ¼



4850-1

HAZET
No.

d x š x v
mm



EAN-No.
4000896+

€

1520/64 275x310x65 64 214556 437,10

1520 Nástrojový kufřík

- „Slim-Line“ – výška jen 105 mm
- Pro univerzální použití např. v domácnosti, při hobby a na zahradě
- Přehledné a bezpečné uložení nářadí
- Ochrana proti vypadnutí nářadí díky svíracímu efektu vložky
- Zakrytá volná přihrádka pro malé díly

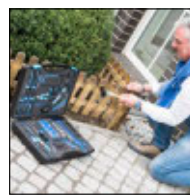

450 N • ●
6x7 • 8x9 • 10x11
12x13 • 14x15 • 16x17
18x19 • 21x22



760-2



802 • ●
0.8x4 • 1x5.5 • 1.2x6.5



802-PH • ●
PH 1 • PH 2



802-PZ • ●
PZ 2



839 • ●
0.5x2.8



880 • ● • □ ¾

8 • 10 • 11 • 12 • 13
14 • 15 • 16 • 17 • 18
19 • 20 • 21 • 22



8816 HP • □ ¾



8821 • □ ¾ • □ ¾

8821-3 • 8821-6



1803-22



1979 N-71

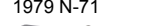

1981



2100 • ○
2 • 2.5 • 3 • 4 • 5 • 6 • 7 • 8

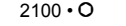

2115/8 KH • ●



2140-50

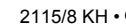

2154-2



2157



2158

HAZET
No.

d x š x v
mm



EAN-No.
4000896+

€

1520/56 445x360x105 56 111183 582,-



Provozní a dílenské zařízení

Nástrojový kufřík



190 L Kovová skříňka na nářadí · prázdná

- 5dílná sada s visacím zámekem
- Stabilní provedení v modročerném designu
- HAZET modrý / černý vypalovaný lak



360°

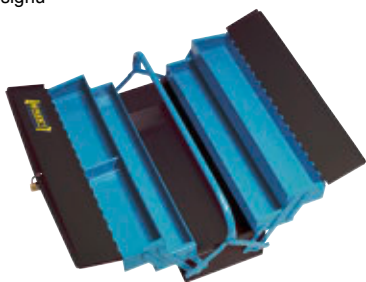

HAZET No.	d x š x v mm	EAN-No. 4000896+	€
190 L	575x210x245	007462	69,25

190 L Plastová skříňka na nářadí

Made in Germany

Mobilní pracoviště

- Pro profesionály a náročné kutily
- Mimořádně robustní provedení
- Maximální objem a úložný prostor navzdory kompaktním rozměrům
- Bezpečné nošení díky odolnému hliníkovému madlu
- Stabilní hliníkové třmenové uzávěry
- Dvě výklopné vložky
- Plast, HAZET modrá / černá



360°



190 L-2



HAZET No.	d x š x v mm	EAN-No. 4000896+	€
• Uvnitř víka dva vyjímatelné malé boxy			
190 L-2	470x250x215	150533	80,70
• Uvnitř víka tři vyjímatelné malé boxy			
190 L-3	550x250x270	133987	93,20

190 L Plastová přenosná skříňka

Made in Germany

- Otevřená a praktická
- Stupnice délkové míry (cm/coul) na horní straně
- Také pro přepravu kapalin a dóz
- Stabilitní hliníková transportní rukojeť
- Plast odolný vůči rozpouštědlům, HAZET modrá
- Stohovatelná



190 L Plastová přenosná skříňka

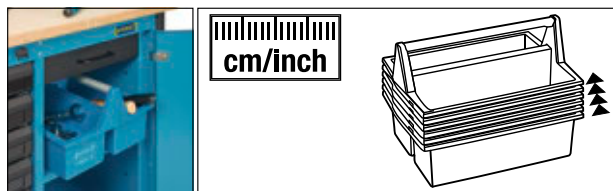

HAZET No.	d x š x v mm	EAN-No. 4000896+	€
190 L-1	396x294x215	133901	19,50

165 SmartCase – skříňka na nářadí

Made in Germany

• Moderní dvoubarevný design HAZET modrá / černá

- Funkce postavení pro rychlý a ergonomický přístup k nářadí
- Víko lze použít jako odkládací plochu pro odebrané nářadí nebo drobné součásti
- Robustní ABS plast – lehčí než kovové skříňky

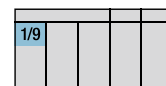

SmartCase S



SmartCase L



HAZET No.	d x š x v mm	EAN-No. 4000896+	€
• Vhodné pro všechny 1/9 úložné vkladací systémy s 2komponentní pěnovou vložkou z programu HAZET			
165-S	185x153x52	167784	23,35
• Vhodné pro všechny 1/3 úložné vkladací systémy s 2komponentní pěnovou vložkou z programu HAZET			
• Držadlo			
165-L	355x235x65	167777	34,20



Sady náradí

0-7 Sada náradí

- Základní sortiment pro mechaniku pro údržbu osobních automobilů
- Safety-Insert-System, 2komponentní vložka z měkké pěny.
- Vložka vhodná také pro HAZET-Assistent

(E)



163-57/56

4 • 5 • 5.5 • 6
7 • 8 • 9 • 10
11 • 12 • 13 • 14

3 • 4 • 5 • 6 • 8

0.6x3.5 • 1x5.5 • 1.2x8

PH 1 • PH 2

PZ 1 • PZ 2

863 HP • 1/4

865

866 U

867-2

868

869

10 • 11 • 12 • 13 • 14 • 15
16 • 17 • 18 • 19 • 20 • 21
22 • 23 • 24 • 26 • 27 • 28
30 • 32 • 34

915

916 HP • 1/2

917-5

918-10

920

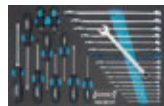

163-58/27

6 • 7 • 8 • 9 • 10
11 • 12 • 13 • 14 • 15
16 • 17 • 18 • 19 • 21
22 • 24

0.4x2.5 • 0.5x3 • 0.6x3.5
0.8x4 • 1.2x6.5 • 1.2x8

PH 1 • PH 2

1x5.5

PH 2

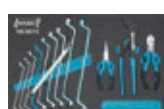

163-59/12

6x7 • 8x9 • 10x11
12x13 • 14x15 • 16x17
18x19 • 20x22 • 21x23

760-2

1802-22

1841 a-22

163-60/22

730-3 • 730-6

746-1

748 b-3 • 748 b-4
748 b-5 • 748 b-6

824 • -
0.5x23

1952-35

1976

2105 Lg/9 H

2140-50

2147 MS

2154-2

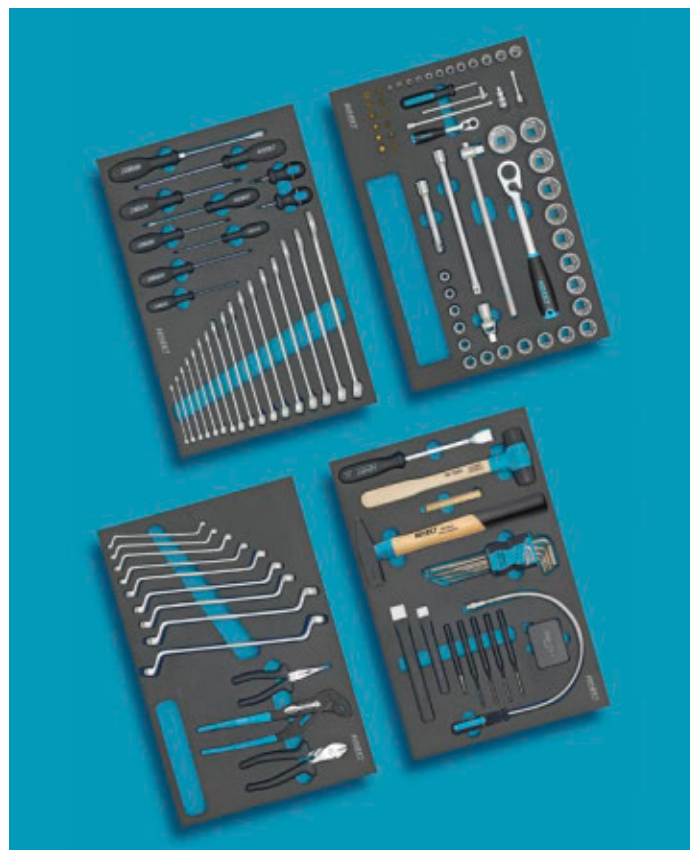



Provozní a dílenské zařízení

Sady nářadí



0-20 Sada nářadí · s ochrannou izolací

- Sortiment nářadí pro elektrikáře
- IEC 60900:2018



- | | | |
|--|--|--|
| 
810 VDE • ●
0.4x2.5 • 0.6x3.5 • 0.8x4 | 
1816 VDE-22 | 
1850 VDE-22 |
| 
810 VDE-PH • ●
PH 1 • PH 2 | 
1826 VDE-22 | 
1862 |
| 
839 • ●
0.5x2.8 | 
1841 a VDE-22 | 
2154 N-3 |
| 
1803 VDE-33 | 
1841 b VDE-33 | |

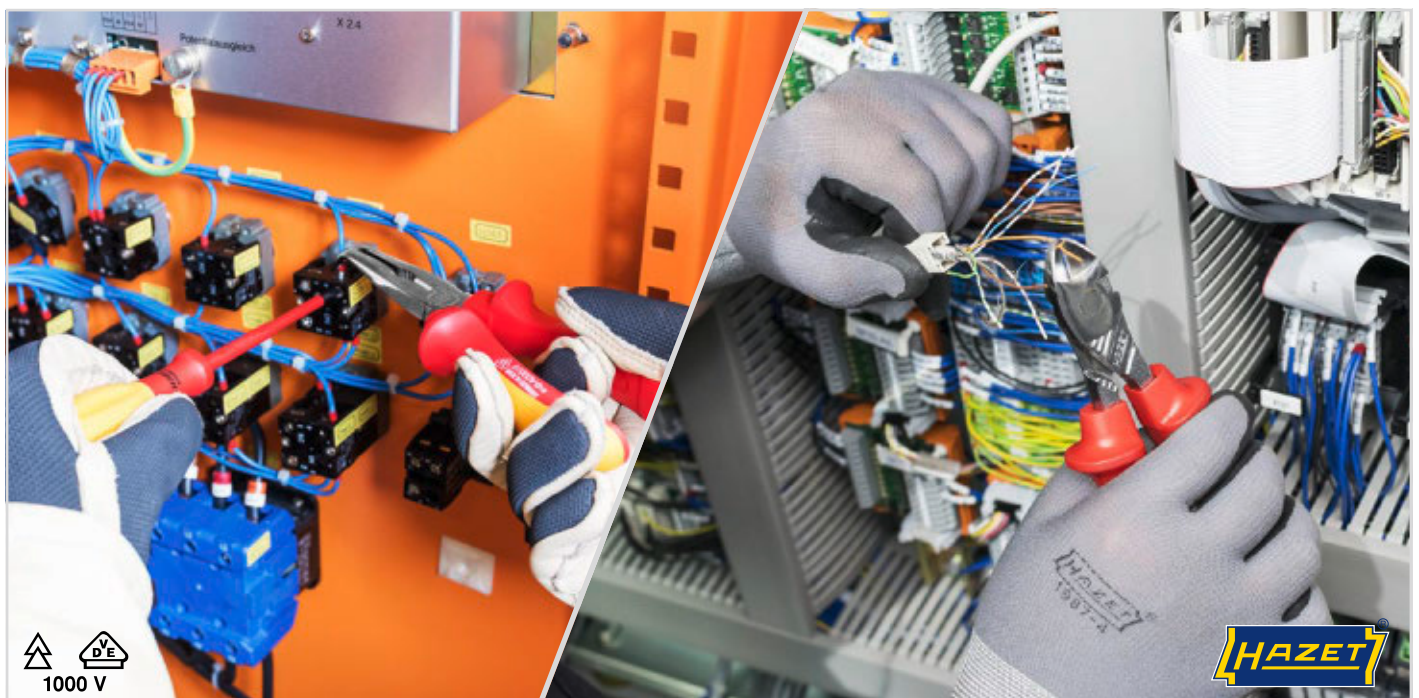

HAZET
No.
0-20/14

14

EAN-No.
4000896+ €
192526 285,60



0-1900 Sada nářadí

Sada nářadí pro karosáře

• Pro dílenský vozík *Assistent*

- | | | | |
|---------------------------|----------------------|------|-------------------|
| | 917-5 • 1/2 • 1/2 | | 1931 |
| 428 • ● | | | 1934 |
| 6 • 7 • 8 • 10 • 11 • 13 | 918-10 • 1/2 • 1/2 | | 1934-1 |
| | | | 1934-4 |
| 600 N • ● | 1810-250 | | 1934 |
| 8 • 9 • 10 • 11 | | | 1934-9 • 1934-10 |
| 12 • 13 • 14 • 15 | 1851-44 | | 1934-10 |
| 17 • 19 • 22 • 24 | | | 1937 K |
| | 1917 N | | 1935-1950 |
| 745-3 | | 1940 | 1940 |
| | 1919 N | | 1935-1950 |
| 745 a-6 | | 1950 | 1950 |
| | 1911-1923 | | 1960-5 |
| 746-1 | 1920 N | | 1961 L-2 |
| | | | 1961 R-2 |
| 757-10 | 1911-1923 | | 1965-5 |
| | 1920 N | | 2130 |
| 760-2 | | | 2140 |
| | 1911-1923 | | 2140-30 • 2140-50 |
| 799-3 | 1921 | | 2143 |
| | 1911-1923 | | 2150 |
| 801 NK • ● | 1921 | | 2165 |
| 1x5.5 | | | 2165-1 • 2165-2 |
| | 1911-1923 | | |
| 803 • ● | 1922 | | |
| 0.4x2.5 • 1x5.5 • 1.2x6.5 | | | |
| 1.2x8 • 1.6x10 | 1911-1923 | | |
| | 1923 | | |
| 803-PH • ● | | | |
| PH 1 • PH 2 • PH 3 | 1927 | | |
| | | | |
| 821-2 | 1929-1 | | |
| | | | |
| 900 • ● • 1/2 | 1927-1930 | | |
| 10 • 11 • 12 • 13 | 1930 | | |
| 15 • 17 • 19 • 22 | | | |
| | | | |
| 916 HP • 1/2 | | | |



- | | | |
|-------------------|------|------|
| | | |
| 2130 | 2140 | 2150 |
| | | |
| 2140-30 • 2140-50 | 2143 | 2165 |
| | | |
| 2165-1 • 2165-2 | | |

HAZET

No.

0-1900/77



77

EAN-No.

4000896+

000241

€

2583,-

HiPer
HIGH PERFORMANCE
THE ORIGINAL
MADE IN GERMANY

6.3 1/4
10 9/16
12 1/2
12 1/2





Provozní a dílenské zařízení

Nástrojové moduly



Nástrojové moduly

163 Sada dvojitých plochých klíčů

Made in Germany



1/3				
-----	--	--	--	--

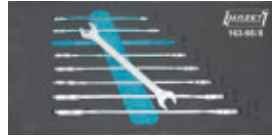

450 N • ●
6x7 • 8x9 • 10x11 • 12x13
14x15 • 16x17 • 18x19 • 21x22

HAZET No.	d x š mm		EAN-No. 4000896+	€
163-95/8	342x172	8	145669	70,90

Made in Germany



Hodí se pro HAZET *Assistent* s hloubkou zásuvky 398 mm:
173 · 179 · 179 N · 179 W · 179 N W · 179 BIG-1 · 179 XL · 179 N XL ·
179 XXL · 179 N XXL · 179 A XXL · 179 T XXL · 180

1/3				
-----	--	--	--	--



450 N • ●
6x7 • 8x9 • 10x11 • 12x13 • 14x15 • 16x18
17x19 • 20x22 • 21x23 • 24x27 • 30x32 • 34x36

HAZET No.	d x š mm		EAN-No. 4000896+	€
163-519/12	392x172	12	218684	132,60

163 Sada očkoplochých klíčů

Made in Germany



1/3				
-----	--	--	--	--



600 N • ●
10 · 11 · 13 · 14 · 15 · 17 · 19 · 22

HAZET No.	d x š mm		EAN-No. 4000896+	€
163-292/8	342x172	8	186372	115,10

Made in Germany



2/3				
-----	--	--	--	--



163 Sada očkoplochých klíčů



600 N • ●
6 · 7 · 8 · 9 · 10 · 11
12 · 13 · 14 · 15 · 16 · 17
18 · 19 · 21 · 22 · 24

HAZET No.	d x š mm		EAN-No. 4000896+	€
163-98/17	344x342	17	145690	277,50

Made in Germany



3/3				
-----	--	--	--	--

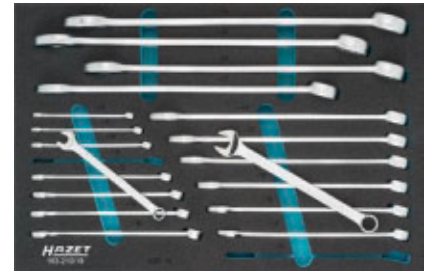

600 N • ●
8 · 9 · 10 · 11 · 12 · 13 · 14
15 · 16 · 17 · 18 · 19 · 21 · 22
24 · 27 · 30 · 32 · 34

HAZET No.	d x š mm		EAN-No. 4000896+	€
163-210/19	519x342	19	164714	385,40

Made in Germany



1/3				
-----	--	--	--	--

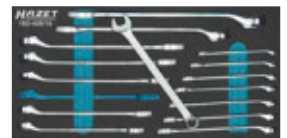

603
● 6 · 7 · 8 · 9
● 10 · 11 · 12 · 13 · 14 · 15
16 · 17 · 18 · 19 · 22

HAZET No.	d x š mm		EAN-No. 4000896+	€
163-428/15	342x172	15	202560	194,20

Made in Germany



2/3				
-----	--	--	--	--



603
● 6 · 7 · 8 · 9
● 10 · 11 · 12 · 13 · 14 · 15 · 16
17 · 18 · 19 · 21 · 22 · 24 · 27

HAZET No.	d x š mm		EAN-No. 4000896+	€
163-99/18	344x342	18	145706	272,30



163 Sada ráčnových očkoplochých klíčů



1/3				
-----	--	--	--	--



606 • ●
8 • 10 • 12 • 13 • 17 • 19

HAZET No.	d x š mm		EAN-No. 4000896+	€
163-97/6	342x172	6	145683	138,80

Hodí se pro HAZET *Assistant* s hloubkou zásuvky 398 mm:
173 · 179 · 179 N · 179 W · 179 N W · 179 BIG-1 · 179 XL ·
179 N XL · 179 XXL · 179 N XXL · 179 A XXL · 179 T XXL · 180



1/3+				
------	--	--	--	--



606 • ●
8 • 9 • 10 • 11 • 12 • 13
14 • 15 • 16 • 17 • 18 • 19

HAZET No.	d x š mm		EAN-No. 4000896+	€
163-509/12	392x172	12	214969	257,90

Hodí se pro HAZET *Assistant* s hloubkou zásuvky 398 mm:
173 · 179 · 179 N · 179 W · 179 N W · 179 BIG-1 · 179 XL ·
179 N XL · 179 XXL · 179 N XXL · 179 A XXL · 179 T XXL · 180



1/3				
-----	--	--	--	--



606 • ●
8 • 9 • 10 • 11 • 12 • 13
14 • 15 • 16 • 17 • 18 • 19



606/4 SPC

HAZET No.	d x š mm		EAN-No. 4000896+	€
163-515/16	392x172	16	218721	303,20



3/3				
-----	--	--	--	--



606 • ●
8 • 9 • 10 • 11 • 12
13 • 14 • 15 • 16 • 17
18 • 19 • 21 • 22 • 24
27 • 30 • 32

HAZET No.	d x š mm		EAN-No. 4000896+	€
163-366/18	519x342	18	196920	607,-

163 Sada oboustranných očkových klíčů



Made in Germany

Hodí se pro HAZET *Assistant* s hloubkou zásuvky 398 mm:
173 · 179 · 179 N · 179 W · 179 N W · 179 BIG-1 · 179 XL · 179 N XL ·
179 XXL · 179 N XXL · 179 A XXL · 179 T XXL · 180

1/3+				
------	--	--	--	--

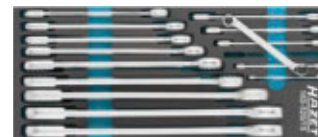

610 N • ●
6x7 • 8x9 • 10x11 • 12x13
14x15 • 16x17 • 18x19 • 20x22
21x22 • 21x23 • 24x26 • 25x28
27x32 • 30x32 • 30x34

HAZET No.	d x š mm	l mm		EAN-No. 4000896+	€
163-520/15	392x172	392	15	218677	307,30

Made in Germany

Hodí se pro HAZET *Assistant* s hloubkou zásuvky 398 mm:
173 · 179 · 179 N · 179 W · 179 N W · 179 BIG-1 · 179 XL · 179 N XL ·
179 XXL · 179 N XXL · 179 A XXL · 179 T XXL · 180



1/3+				
------	--	--	--	--



630 • ●
6x7 • 8x9 • 10x11
12x13 • 14x15 • 16x17
18x19 • 20x22 • 21x23

HAZET No.	d x š mm	l mm		EAN-No. 4000896+	€
163-518/9	392x172	392	9	218707	142,90

163 Sada šroubových klíčů / nástrčných hlavíc

Made in Germany



2/3				
-----	--	--	--	--



450 N • ●
8x9 • 10x11
12x13 • 14x15
16x18 • 17x19
20x22 • 21x22
24x27 • 30x32
34x36



1010 • ○ • 20 3/4
14 • 17 • 19 • 22



1058-1 • 25 1 • 20 3/4
1058-2 • 25 1/2 • 20 3/4



1012 • ● • 20 3/4
T 60 • T 80 • T 100

HAZET No.	d x š mm		EAN-No. 4000896+	€
163-211/20	344x342	20	164707	410,-



Provozní a dílenské zařízení

Nástrojové moduly



163 Sada nářadí

Made in Germany

Hodí se pro HAZET *Assistent* s hloubkou zásuvky 398 mm:
173 · 179 · 179 N · 179 W · 179 N W · 179 BIG-1 · 179 XL ·
179 N XL · 179 XXL · 179 N XXL ·
179 A XXL · 179 T XXL · 180

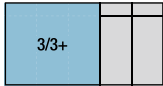
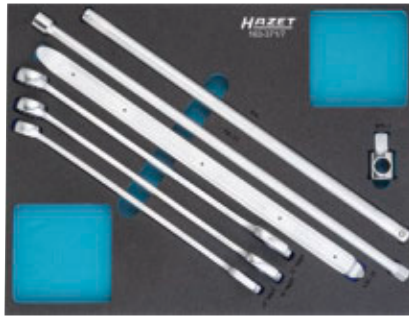

600 N • ●
27 · 30 · 32

918-23 • 12 1/2 • 12 1/2

1015-1 • 20 3/4

650-20

1014

HAZET No.	d x š mm		EAN-No. 4000896+	€
163-371/7	519x392	7	196777	260,-

163 Sada šroubovacích klíčů

Made in Germany

Hodí se pro HAZET *Assistent* s hloubkou zásuvky 398 mm:
173 · 179 · 179 N · 179 W · 179 N W · 179 BIG-1 ·
179 XL · 179 N XL · 179 XXL · 179 N XXL · 179 A XXL ·
179 T XXL · 180

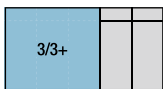
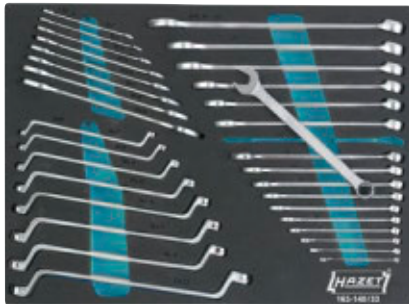

450 N • ●
6x7 · 8x9 · 10x11
12x13 · 14x15 · 16x17
18x19 · 21x22

600 N • ●
6 · 7 · 8 · 9 · 10
11 · 12 · 13 · 14 · 15
16 · 17 · 18 · 19 · 21
22 · 24

630 • ●
6x7 · 8x9 · 10x11
12x13 · 14x15 · 16x17
18x19 · 21x22

HAZET No.	d x š mm		EAN-No. 4000896+	€
163-140/33	519x392	33	151899	493,20

Hodí se pro HAZET *Assistent* s rozměry zásuvek minimálně 398x694 mm:
179 XL · 179 N XL · 179 XXL · 179 N XXL
a 179 A XXL · 179 T XXL do horní zásuvky

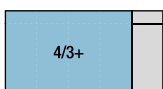
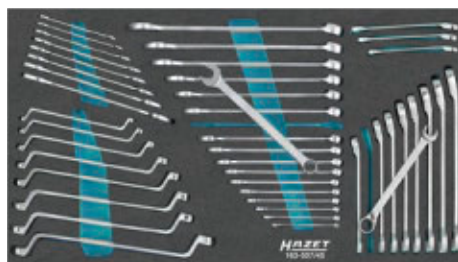

163 Sada šroubovacích klíčů



450 N • ●
6x7 · 8x9
10x11 · 12x13
14x15 · 16x17
18x19 · 21x22

600 N • ●
6 · 7 · 8 · 9
10 · 11 · 12 · 13
14 · 15 · 16 · 17
18 · 19 · 21 · 22
24

606 • ●
8 · 9 · 10 · 11
12 · 13 · 14 · 15
16 · 17 · 18 · 19

630 • ●
6x7 · 8x9
10x11 · 12x13
14x15 · 16x17
18x19 · 21x22

HAZET No.	d x š mm		EAN-No. 4000896+	€
163-507/45	691x392	45	214938	719,-

Made in Germany

Hodí se pro HAZET *Assistent* s rozměry zásuvek minimálně 398x694 mm:
179 XL · 179 N XL · 179 XXL · 179 N XXL
a 179 A XXL · 179 T XXL do horní zásuvky

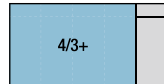

450 N • ●
6x7 · 8x9 · 10x11
12x13 · 14x15 · 16x18
17x19 · 21x22 · 22x24
24x27 · 30x32 · 34x36

600 N • ●
8 · 9 · 10 · 11 · 12
13 · 14 · 15 · 16 · 17
18 · 19 · 21 · 22 · 24
27 · 30 · 32 · 34

630 • ●
6x7 · 8x9 · 10x11
12x13 · 14x15 · 16x17
18x19 · 21x22 · 24x27

HAZET No.	d x š mm		EAN-No. 4000896+	€
163-478/40	691x392	40	207831	771,-

Made in Germany

Hodí se pro HAZET *Assistent* s hloubkou zásuvky 398 mm:
173 · 179 · 179 N · 179 W · 179 N W ·
179 BIG-1 · 179 XL · 179 N XL · 179 XXL · 179 N XXL ·
179 A XXL · 179 T XXL · 180

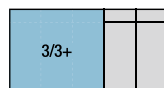
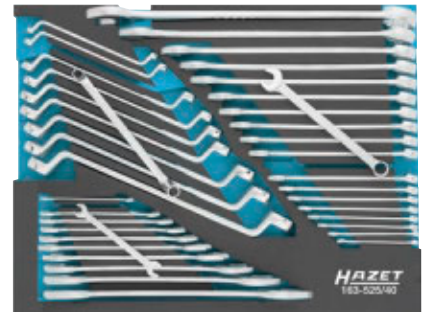

450 N • ●
6x7 · 8x9 · 10x11
12x13 · 14x15 · 16x17
18x19 · 21x22 · 24x27
30x32 · 34x36

600 N • ●
6 · 7 · 8 · 9 · 10
11 · 12 · 13 · 14 · 15
16 · 17 · 18 · 19 · 21
22 · 24 · 27 · 32

630 • ●
6x7 · 8x9 · 10x11
12x13 · 14x15 · 16x17
18x19 · 20x22 · 21x23
24x27

HAZET No.	d x š mm		EAN-No. 4000896+	€
163-525/40	519x392	40	218639	681,-



163 Sada šroubovacích klíčů

Hodí se pro HAZET *Assistent* s rozměry zásuvek minimálně 398x694 mm:
179 XL · 179 N XL · 179 XXL · 179 N XXL
a 179 A XXL · 179 T XXL do horní zásuvky

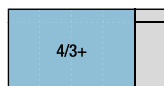

450 N • ●
6x7 · 8x9 · 10x11
12x13 · 14x15 · 16x17
18x19 · 21x22 · 24x27
30x32 · 34x36

600 N • ●
6 · 7 · 8 · 9 · 10
11 · 12 · 13 · 14 · 15
16 · 17 · 18 · 19 · 21
22 · 24 · 27 · 32

606/4 SPC

606 • ●
8 · 9 · 10 · 11
12 · 13 · 14 · 15
16 · 17 · 18 · 19

630 • ●
6x7 · 8x9 · 10x11
12x13 · 14x15 · 16x17
18x19 · 20x22 · 21x23
24x27

HAZET No.	d x š mm		EAN-No. 4000896+	€
163-528/56	691x392	56	218622	878,-

163 Sada očkoplochých / dvojíých očkových klíčů

Made in Germany

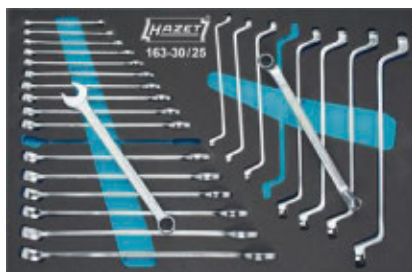
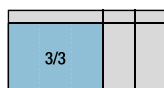

600 N • ●
6 · 7 · 8 · 9 · 10 · 11 · 12 · 13
14 · 15 · 16 · 17 · 18 · 19 · 21 · 22 · 24

630 • ●
6x7 · 8x9 · 10x11 · 12x13
14x15 · 16x17 · 18x19 · 21x22

HAZET No.	d x š mm		EAN-No. 4000896+	€
163-30/25	519x342	25	118601	405,90

163 Sada šroubovacích klíčů

Made in Germany



Hodí se pro HAZET *Assistent* s hloubkou zásuvky 398 mm:
173 · 179 · 179 N · 179 W ·
179 N W · 179 BIG-1 · 179 XL ·
179 N XL · 179 XXL · 179 N XXL ·
179 A XXL · 179 T XXL · 180

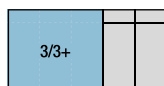
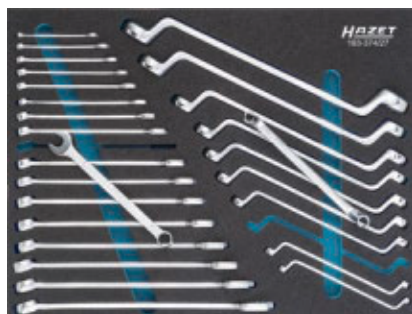

163 Sada šroubovacích klíčů



600 N • ●
6 · 7 · 8 · 9 · 10 · 11 · 12 · 13 · 14
15 · 16 · 17 · 18 · 19 · 21 · 22 · 24

630 • ●
6x7 · 8x9 · 10x11 · 12x13
14x15 · 16x17 · 18x19 · 21x22
24x27 · 30x32

HAZET No.	d x š mm		EAN-No. 4000896+	€
163-374/27	519x392	27	196753	452,10

163 Sada nástrčných hlavic

Made in Germany

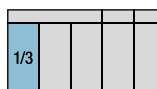

880 TZ • ● • □ 3/8
9 · 10 · 11 · 12 · 13
14 · 15 · 16 · 17 · 18
19 · 20 · 21 · 22

HAZET No.	d x š mm		EAN-No. 4000896+	€
163-259/14	342x172	14	179558	169,60

Made in Germany

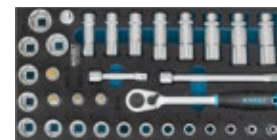
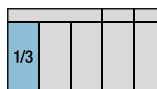

880 • ● • □ 3/8
6 · 7 · 8 · 9 · 10
11 · 12 · 13 · 14 · 15
16 · 17 · 18 · 19 · 20
21 · 22

8801 K • ● • □ 3/8
5 · 6 · 8 · 10

8816 HP • □ 3/8

880 LG • ● • □ 3/8
12 · 13 · 14 · 15
16 · 17 · 18 · 19

8820 • □ 3/8 • □ 3/8
8821 • □ 3/8 • □ 3/8
8821-3 · 8821-6

HAZET No.	d x š mm		EAN-No. 4000896+	€
163-483/33	342x172	33	207770	318,60

Made in Germany



Hodí se pro HAZET *Assistent* s hloubkou zásuvky 398 mm:
173 · 179 · 179 N · 179 W · 179 N W · 179 BIG-1 · 179 XL · 179 N XL ·
179 XXL · 179 N XXL · 179 A XXL · 179 T XXL · 180

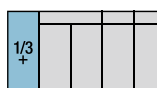



Provozní a dílenské zařízení

Nástrojové moduly



163 Sada nástrčných klíčů

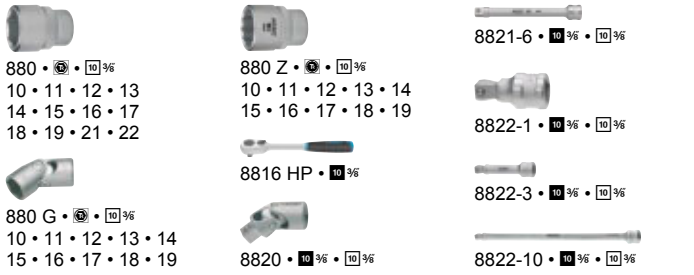

HAZET No.	d x š mm		EAN-No. 4000896+	€
163-379/38	392x172	38	196791	545,-

163 Sada nástrčných hlavíc

Made in Germany



HAZET No.	d x š mm		EAN-No. 4000896+	€
163-302/6	172x114	6	190348	70,90

Made in Germany



HAZET No.	d x š mm		EAN-No. 4000896+	€
163-460/7	172x114	7	204939	90,45

Made in Germany

Hodí se pro HAZET *Assistant* s hloubkou zásuvky 398 mm:
 173 · 179 · 179 N · 179 W ·
 179 N W · 179 BIG-1 · 179 XL · 179 N XL · 179 XXL ·
 179 N XXL · 179 A XXL · 179 T XXL · 180

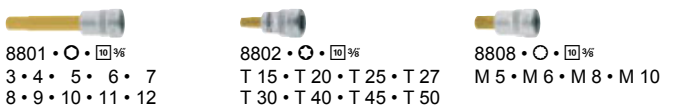

HAZET No.	d x š mm		EAN-No. 4000896+	€
163-571/22	392x172	22	233434	219,90

163 Sada nástrčných hlavíc

Made in Germany

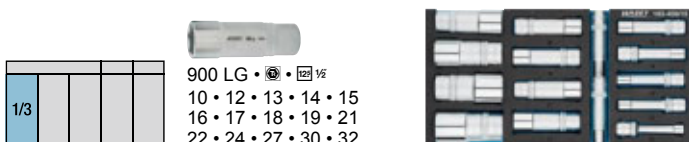

HAZET No.	d x š mm		EAN-No. 4000896+	€
163-272/32	342x172	32	181414	358,60

163 Sada nástrčných hlavíc

HAZET No.	d x š mm		EAN-No. 4000896+	€
163-459/15	342x172	15	204649	255,90

Made in Germany

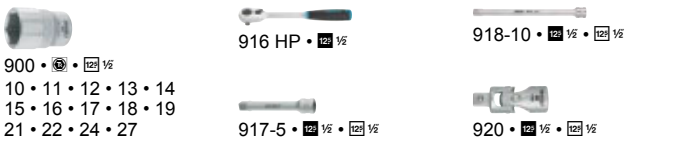

HAZET No.	d x š mm		EAN-No. 4000896+	€
163-191/18	342x172	18	162307	231,20

Made in Germany

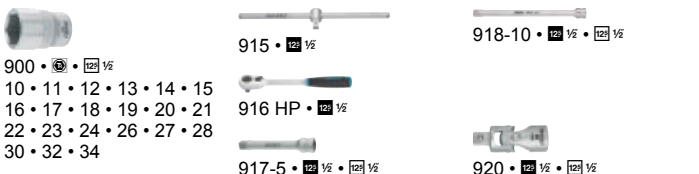

HAZET No.	d x š mm		EAN-No. 4000896+	€
163-102/27	344x342	26	145935	344,30

Made in Germany

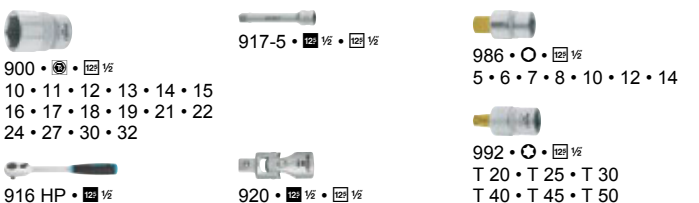

HAZET No.	d x š mm		EAN-No. 4000896+	€
163-272/32	342x172	32	181414	358,60



163 Sada nástrčných hlavic

Made in Germany

TIN E 12 1/2

1/9				
-----	--	--	--	--

986 • \odot • 12 1/2
5 • 6 • 7 • 8 • 10

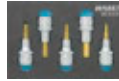

HAZET No.	d x š mm		EAN-No. 4000896+	€
163-215/5	172x114	5	168217	59,60

Made in Germany

TIN E 12 1/2

1/9				
-----	--	--	--	--

986 • \odot • 12 1/2
5 • 6 • 7 • 8 • 10
12 • 14 • 17 • 19



HAZET No.	d x š mm		EAN-No. 4000896+	€
163-270/9	172x114	9	181063	112,-

Made in Germany

TIN E 12 1/2

1/3				
-----	--	--	--	--

986 • \odot • 12 1/2
5 • 6 • 7 • 8 • 10 • 12 • 14 • 17 • 19

986 KK • \odot • 12 1/2
6 • 7 • 8 • 10



HAZET No.	d x š mm		EAN-No. 4000896+	€
163-220/13	342x172	13	168286	159,30

163 Sada nástrčných hlavic · XZN

Made in Germany

TIN E 12 1/2

1/9				
-----	--	--	--	--

990 • \odot • 12 1/2
M 6 • M 8 • M 10 • M 12
M 14 • M 16 • M 18



HAZET No.	d x š mm		EAN-No. 4000896+	€
163-243/7	172x114	7	178032	101,80

163 Sada nástrčných klíčů

Made in Germany

E 20 3/4

3/3				
-----	--	--	--	--



163 Sada nástrčných klíčů

E 20 3/4

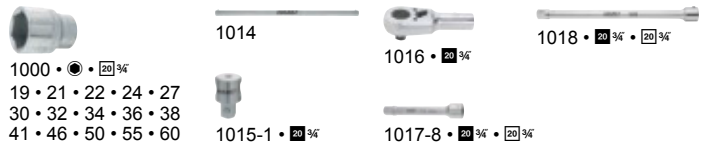

HAZET No.	d x š mm		EAN-No. 4000896+	€
163-406/20	519x342	20	200054	705,-

Made in Germany

E 12 1/2 6.3 1/4

Hodí se pro HAZET *Assistant* s
hloubkou zásuvky 398 mm:
173 · 179 · 179 N · 179 W ·
179 N W · 179 BIG-1 · 179 XL ·
179 N XL · 179 XXL · 179 N XXL ·
179 A XXL · 179 T XXL · 180



3/3+				
------	--	--	--	--

850 • \odot • 12 1/2
4 • 5 • 5.5 • 6
7 • 8 • 9 • 10
11 • 12 • 13 • 14

869 • \odot • 12 1/2
3 • 4 • 5 • 6 • 8

903 SLG • \odot • 12 1/2
17 • 19

850 LG • \odot • 12 1/2
4 • 5 • 5.5 • 6
7 • 8 • 9 • 10
11 • 12 • 13

8501 • \odot • 12 1/2
3 • 4 • 5 • 6 • 8

915 • 12 1/2

858-1 • \odot • 10 3/8 • 12 1/2

8503 • \odot • 12 1/2
0.6x3.5 · 1x5.5 · 1.2x8

917-5 • 12 1/2

863 HP • 12 1/2

8506 • \odot • 12 1/2
PH 1 · PH 2

918-10 • 12 1/2

865 • 12 1/2

8507 • \odot • 12 1/2
PZ 1 · PZ 2

919-1 • 12 1/2

866 U • 12 1/2

900 • \odot • 12 1/2
10 · 11 · 12 · 13 · 14
15 · 16 · 17 · 18 · 19
20 · 21 · 22 · 24 · 27
30 · 32

920 • 12 1/2

867-2 • 12 1/2

958-1 • 20 3/4

958-2 • 10 3/8

868 • 12 1/2

986 • \odot • 12 1/2
5 • 6 • 7 • 8
10 · 12 · 14 · 17

958-1 • 20 3/4

HAZET No.	d x š mm		EAN-No. 4000896+	€
163-138/77	519x392	77	151875	781,-

163 Sada nářadí · TORX®

Made in Germany

TIN E 6.3 1/4

--	--	--	--	--

850 E • \odot • 12 1/2
E 4 · E 5 · E 6 · E 7
E 8 · E 10 · E 11

8502 • \odot • 12 1/2
T 10 · T 15 · T 20 · T 25
T 27 · T 30 · T 40

HAZET No.	d x š mm		EAN-No. 4000896+	€
163-251/14	172x50	14	178063	88,40



Provozní a dílenské zařízení

Nástrojové moduly



163 Sada adaptérů

Made in Germany

ⓔ 6.3 1/4 10 3/8 12.5 1/2 20 3/4
6.3 1/4 10 3/8 12.5 1/2 20 3/4

1/9				
-----	--	--	--	--



858-1 • 10 3/8 • 6.3 1/4

958-1 • 20 3/8 • 12.5 1/2
958-2 • 10 3/8 • 12.5 1/2

8858-1 • 12.5 1/2 • 10 3/8
8858-2 • 6.3 1/4 • 10 3/8

1058-2 • 12.5 1/2 • 20 3/4

HAZET No.	d x š mm		EAN-No. 4000896+	€
163-217/6	172x114	6	168231	82,20

163 Sada nástrčných hlavíc

Made in Germany

ⓔ 6.3 1/4 10 3/8 12.5 1/2 20 3/4

--	--	--	--	--



858-1 • 10 3/8 • 6.3 1/4

903 SLG • 17 • 19

958-1 • 20 3/8 • 12.5 1/2
958-2 • 10 3/8 • 12.5 1/2

8858-1 • 12.5 1/2 • 10 3/8
8858-2 • 6.3 1/4 • 10 3/8

1058-2 • 12.5 1/2 • 20 3/4

HAZET No.	d x š mm		EAN-No. 4000896+	€
163-131/8	519x50	8	153626	107,90

Hodí se pro HAZET *Assistent* s hloubkou zásuvky 398 mm:
173 · 179 · 179 N · 179 W · 179 N W · 179 BIG-1 · 179 XL · 179 N XL · 179 XXL · 179 N XXL · 179 A XXL · 179 T XXL · 180

ⓔ 12.5 1/2 10 3/8 6.3 1/4 6.3 1/4

3/3+				
------	--	--	--	--



609 •
E 6, E 8 • E 10, E 12
E 14, E 18 • E 20, E 24

880 E • 10 3/8
E 10 • E 11 • E 12 • E 14

880 LG • 10 3/8
10 • 11 • 12 • 13

880 • 10 3/8
7 • 8 • 9 • 10 • 11
12 • 13 • 14 • 15 • 16
17 • 18 • 19 • 21 • 22

880 G • 10 3/8
10 • 11 • 12 • 13
14 • 15 • 16

8801 K • 10 3/8
9

850 E • 6.3 1/4
E 4 • E 5 • E 6 • E 7 • E 8

880 G-E • 10 3/8
E 8 • E 10

8802 • 10 3/8
T 40 • T 45

Jednotlivé a náhradní díly od strany 482 po stranu 490

163 Sada nástrčných klíčů

ⓔ 12.5 1/2 10 3/8 6.3 1/4 6.3 1/4

8808 • 10 3/8
M 6 • M 8 • M 10

900 E • 12.5 1/2
E 16 • E 18 • E 20 • E 24

2223 • 6
T 6

8816 HP • 10 3/8

992 • 12.5 1/2
T 50 • T 55 • T 60

2223 • 6
T 7 H • T 8 H • T 9 H
T 10 H • T 15 H • T 20 H
T 25 H • T 27 H • T 30 H
T 40 H

8816 GK • 10 3/8

8820 • 10 3/8 • 10 3/8

2115 •
T 6 • T 7 • T 8 • T 9
T 10 • T 15 • T 20 • T 25
T 27 • T 30 • T 40

2223 LG • 6
T 25

8821 • 10 3/8 • 10 3/8
8821-3 • 8821-6 • 8821-10

2250-1 • 6.3 1/4
2250-2 • 6.3 1/4

2250-1 • 6.3 1/4
2250-2 • 6.3 1/4

8858-1 • 12.5 1/2 • 10 3/8
8858-2 • 6.3 1/4 • 10 3/8

2215 • 6.3 1/4
PH 1 • PH 2 • PH 3

863 HP B •

HAZET No.	d x š mm		EAN-No. 4000896+	€
163-139/90	519x392	90	151882	1028,-

163 Sada nástrčných klíčů · TORX® dvojity očkový klíč · nástrčný klíč atd.

ⓔ 12.5 1/2 10 3/8 6.3 1/4 6.3 1/4

3/3				
-----	--	--	--	--

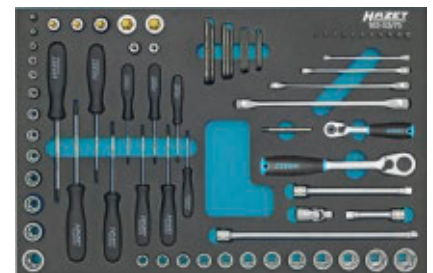

609 •
E 6, E 8 • E 10, E 12
E 14, E 18 • E 20, E 24

8802 • 10 3/8
T 40 • T 45

2115 •
T 6 • T 7 • T 8 • T 9
T 10 • T 15 • T 20 • T 25
T 27 • T 30 • T 40

803-T •
T 6 • T 7 • T 8 • T 9
T 10 • T 15 • T 20 • T 25
T 27 • T 30

8816 HP • 10 3/8

2223 • 6
T 6

850 E • 6.3 1/4
E 4 • E 5 • E 6 • E 7 • E 8

8820 • 10 3/8 • 10 3/8
8821 • 10 3/8 • 10 3/8
8821-3 • 8821-6 • 8821-10

2223 • 6
T 7 H • T 8 H • T 9 H
T 10 H • T 15 H • T 20 H
T 25 H • T 27 H • T 30 H
T 40 H

880 • 10 3/8
10 • 11 • 12 • 13
14 • 15 • 16 • 17
18 • 19 • 21 • 22

900 E • 12.5 1/2
E 16 • E 18 • E 20 • E 24

2223 LG • 6
T 25

880 E • 10 3/8
E 10 • E 11 • E 12 • E 14

992 • 12.5 1/2
T 50 • T 55 • T 60

2250-1 • 6.3 1/4
2250-2 • 6.3 1/4

863 HP B •

HAZET No.	d x š mm		EAN-No. 4000896+	€
163-53/75	519x342	75	122783	653,-

Nezávazně doporučená ceníková cena bez DPH – Platí do 31.12.2021



163 Sada nářadí · TORX®

Made in Germany

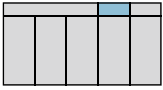

880 E • • 3/8
E 8 • E 10 • E 12 • E 14



8802 • • 3/8
T 25 • T 30 • T 40
T 45 • T 50

HAZET No.	dxš mm		EAN-No. 4000896+	€
163-252/9	172x50	9	178070	86,35

163 Sada nástrčných klíčů

Hodí se pro HAZET *Assistent* s hloubkou zásuvky 398 mm:
173 · 179 · 179 N · 179 W · 179 N W ·
179 BIG-1 · 179 XL · 179 N XL · 179 XXL ·
179 N XXL · 179 A XXL · 179 T XXL · 180

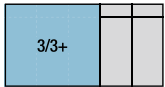

850 • • 1/4
4 · 5 · 5.5 · 6
7 · 8 · 9 · 10
11 · 12 · 13 · 14



850 E • • 1/4
E 4 · E 5 · E 6 · E 7 · E 8



8501 • • 1/4
3 · 4 · 5 · 6



8502 • • 1/4
T 10 · T 15 · T 20
T 25 · T 27



8503 • • 1/4
1x5.5



8506 • • 1/4
PH 1 · PH 2



858-1 • • 3/8 • 1/4



863 HP • • 1/4



866 U • • 1/4



867-2 • • 1/4 • 3/8

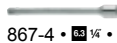

867-4 • • 1/4 • 3/8



868 • • 1/4 • 3/8



869 • • 1/4 • 3/8

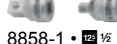

8858-1 • • 1/2 • 3/8 • 1/4

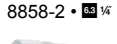

8858-2 • • 1/4 • 3/8 • 1/2



900 • • 1/2
10 · 11 · 12 · 13 · 14
15 · 16 · 17 · 18 · 19
20 · 21 · 22 · 24 · 27
30 · 32



900 E • • 1/2
E 10 · E 12 · E 14
E 16 · E 18 · E 20



900 SZ • • 1/2
32 · 36



900 Z • • 1/2
8 · 9 · 10 · 12 · 13
14 · 15 · 16 · 17 · 18
19 · 21 · 22 · 24 · 27
30 · 32

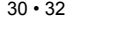

2223 • • 3/8 • 1/2



903 SLG • • 1/2 • 3/8
17 · 19



915 • • 1/2

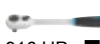

916 HP • • 1/2



919 • • 1/2 • 3/8 • 1/2

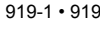

919-1 · 919-5 · 919-10

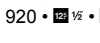

920 • • 1/2 • 3/8 • 1/2

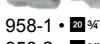

958-1 • • 3/8 • 1/2 • 3/8



958-2 • • 1/4 • 3/8 • 1/2

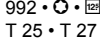

992 • • 1/2

T 25 · T 27 · T 30 · T 40

T 45 · T 50 · T 55 · T 60

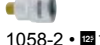

1058-2 • • 1/2 • 3/8 • 1/2



2223 • • 3/8 • 1/2

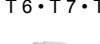

T 6 · T 7 · T 8 · T 9

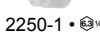

2250-1 • • 1/4 • 3/8 • 1/2

HAZET No.	dxš mm		EAN-No. 4000896+	€
163-369/104	519x392	104	196722	966,-

163 Sada nářadí

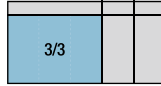
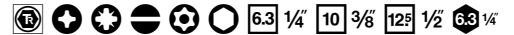

751 HS/5



850 • • 1/4 • 3/8



6 · 7 · 8 · 9



10 · 11 · 12 · 13



863 HP • • 1/4



867-2 • • 1/4 • 3/8 • 1/2



880 • • 3/8

10 · 12 · 13 · 14

16 · 17 · 19



8816 HP • • 3/8



8821-10 • • 3/8 • 1/2



900 • • 1/2 • 3/8

13 · 14 · 15 · 16 · 17

18 · 19 · 21 · 22 · 24



27 · 30 · 32

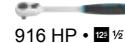

916 HP • • 1/2

917-5 • • 1/2 • 3/8 • 1/2

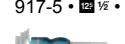

2105 Lg/9 H · O

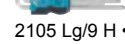

2240 N/51

• 1/4 • 3/8 • 1/2 • 3/8 • 1/2 • 3/8 • 1/2



2250-1 • • 1/4 • 3/8 • 1/2

HAZET No.	dxš mm		EAN-No. 4000896+	€
163-329/100	519x342	100	191833	519,-

163 Sada nástrčných klíčů

Hodí se pro HAZET *Assistent* s rozměry zásuvek minimálně 398x694 mm:
179 XL · 179 N XL · 179 XXL · 179 N XXL
a 179 A XXL · 179 T XXL do horní zásuvky

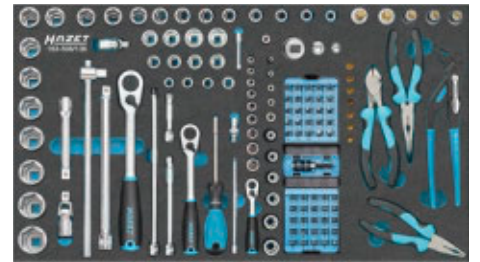
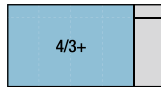

760-2



810 SPC-6.3 • • 1/4



850 • • 1/4 • 3/8



5.5 · 6 · 7 · 8 · 9



10 · 11 · 12 · 13



850 E • • 1/4 • 3/8



E 5 · E 6 · E 7 · E 8 · E 10



8502 • • 1/4 • 3/8



863 HP • • 1/4



867-2 • • 1/4 • 3/8 • 1/2



868 • • 1/4 • 3/8



869 • • 1/4 • 3/8



880 • • 3/8



10 · 11 · 12 · 13



14 · 15 · 16 · 17



18 · 19 · 21 · 22



8816 HP • • 3/8



8821 • • 3/8 • 1/2 • 3/8



8821-3 · 8821-6 · 8821-10



8858-2 • • 1/4 • 3/8 • 1/2



900 • • 1/2 • 3/8

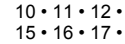

10 · 11 · 12 · 13 · 14

15 · 16 · 17 · 18 · 19

20 · 21 · 22 · 23 · 24

26 · 27 · 28 · 30 · 32



900 E • • 1/2 • 3/8

E 10 · E 12 · E 14

E 16 · E 18 · E 20

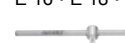

915 • • 1/2



916 HP • • 1/2



917-5 • • 1/2 • 3/8 • 1/2



Provozní a dílenské zařízení

Nástrojové moduly



163 Sada nástrčných klíčů

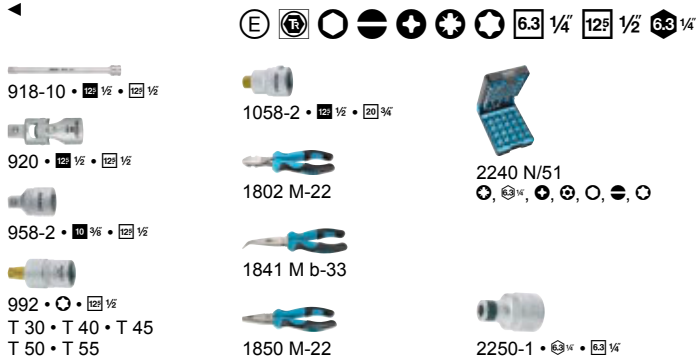

HAZET No.	d x š mm	□	EAN-No. 4000896+	€
163-508/138	691x392	138	214907	1018,-

Hodí se pro HAZET *Assistent* s rozměry zásuvek minimálně 398x694 mm: 179 XL · 179 N XL · 179 XXL · 179 N XXL a 179 A XXL · 179 T XXL do horní zásuvky

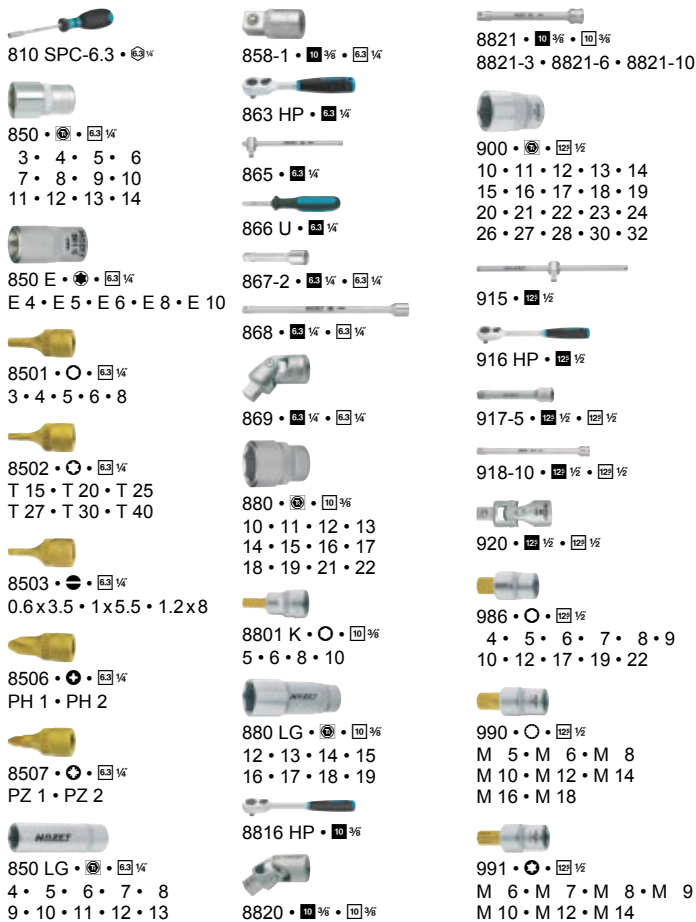
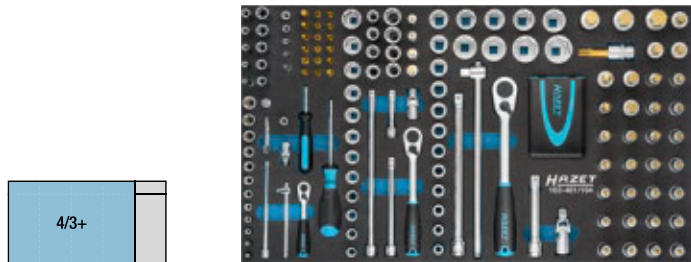

163 Sada nástrčných klíčů



HAZET No.	d x š mm	□	EAN-No. 4000896+	€
163-481/194	691x392	194	208227	1429,-

Hodí se pro HAZET *Assistent* s rozměry zásuvek minimálně 398x694 mm: 179 XL · 179 N XL · 179 XXL · 179 N XXL a 179 A XXL · 179 T XXL do horní zásuvky

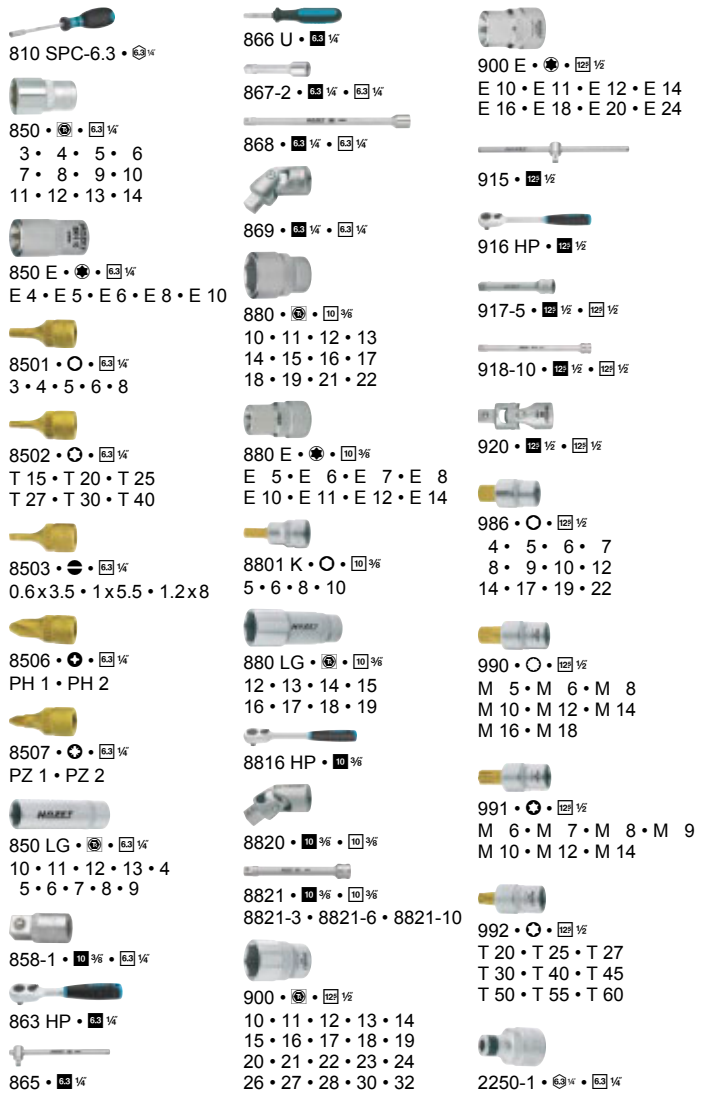
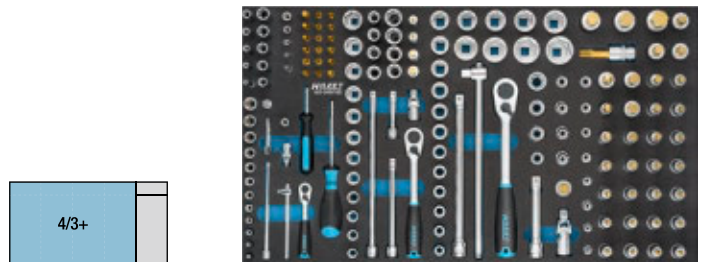

HAZET No.	d x š mm	□	EAN-No. 4000896+	€
163-549/160	691x392	160	224388	1335,-



Provozní a dílenské zařízení

Nástrojové moduly



163 Sada nástrčných hlavíc

Made in Germany



2/3			
-----	--	--	--

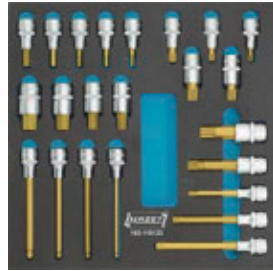

986 • •
5 • 6 • 7 • 8 • 10
12 • 14 • 17 • 19

990 • •
M 8 • M 10 • M 12
M 14 • M 16 • M 18

990 SLG • •
M 10 • M 12

986 KK • •
6 • 7 • 8 • 10

990 LG • •
M 8 • M 14

HAZET No.	d x š mm		EAN-No. 4000896+	€
163-119/23	344x342	23	153510	303,20

Made in Germany



1/3			
-----	--	--	--

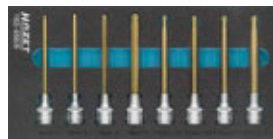

986 KK • •
5 • 6 • 8 • 10

992 SLG • •
T 30 • T 40 • T 45 • T 50

HAZET No.	d x š mm		EAN-No. 4000896+	€
163-468/8	342x172	8	205479	121,30

Made in Germany



2/3			
-----	--	--	--

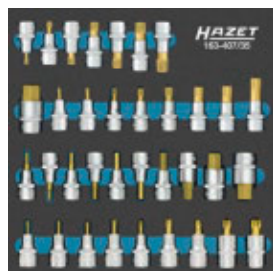

986 • •
4 • 5 • 6 • 7
8 • 9 • 10 • 12
17 • 19 • 22

990 • •
M 5 • M 6 • M 8
M 10 • M 12 • M 14
M 16 • M 18

991 • •
M 6 • M 7 • M 8
M 9 • M 10 • M 12
M 14

992 • •
T 20 • T 25 • T 27
T 30 • T 40 • T 45
T 50 • T 55 • T 60

HAZET No.	d x š mm		EAN-No. 4000896+	€
163-407/35	344x342	35	199990	431,60

163 Sada nástrčných hlavíc TORX®

Made in Germany



1/9			
-----	--	--	--

992 • •
T 20 • T 25 • T 27 • T 30 • T 40
T 45 • T 50 • T 55 • T 60



HAZET No.	d x š mm		EAN-No. 4000896+	€
163-271/9	172x114	9	181056	150,-

163 Sada flexibilních šroubováků

Made in Germany



1/3			
-----	--	--	--

426 •
5 • 6 • 7 • 8 • 10



HAZET No.	d x š mm		EAN-No. 4000896+	€
163-461/5	342x172	5	204625	132,60

163 Sada nástrčných klíčů s T-rukojetí

Made in Germany



1/3			
-----	--	--	--

428 •
8 • 10 • 13

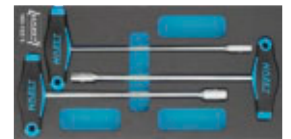

HAZET No.	d x š mm		EAN-No. 4000896+	€
163-122/3	342x172	3	153534	58,60

Made in Germany



Hodí se pro HAZET *Assistant* s hloubkou zásuvky 398 mm:
173 • 179 • 179 N • 179 W • 179 N W • 179 BIG-1 • 179 XL • 179 N XL •
179 XXL • 179 N XXL • 179 A XXL • 179 T XXL • 180

1/3 +			
-------	--	--	--

428 •
8 • 10 • 13

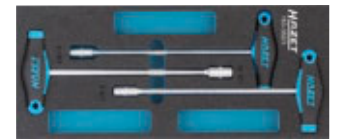

HAZET No.	d x š mm		EAN-No. 4000896+	€
163-382/3	392x172	3	196821	60,65

163 Sada šroubováků HEXAnamic®



1/3			
-----	--	--	--

802 •
0,8x4 • 1x5,5 • 1,2x6,5 • 1,2x8

802-PH •
PH 1 • PH 2

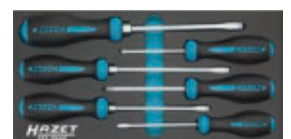

HAZET No.	d x š mm		EAN-No. 4000896+	€
163-184/6	342x172	6	161461	66,80



163 Sada šroubováků

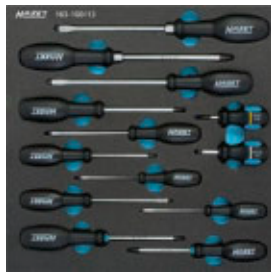

2/3		
-----	--	--

803 •
 0.4x2.5 • 0.5x3 • 0.6x3.5
 0.8x4 • 1.2x6.5 • 1.2x8

801 NK-PH •
 PH 2

803-PZ •
 PZ 1 • PZ 2

801 NK •
 1x5.5

803-PH •
 PH 1 • PH 2 • PH 3

HAZET No.	d x š mm		EAN-No. 4000896+	€
163-100/13	344x342	13	145713	101,80

163 Sada nářadí



3/3		
-----	--	--

810/6 • •

810 T/6 •

1859 SPC/3

2140-50

HAZET No.	d x š mm		EAN-No. 4000896+	€
163-330/16	519x342	16	191826	163,40

163 Sada šroubováků



2/3		
-----	--	--

810 U-1/5 • •

810/6 • •

810 T/6 •

2105 Lg/9 H •

HAZET No.	d x š mm		EAN-No. 4000896+	€
163-297/26	344x342	26	186242	142,90

163 Univerzální sada



3/3		
-----	--	--

730
 730-3 • 730-6

801 NK •
 1x5.5

1802 M-22

746-1

801 NK-PH •
 PH 2

1841 M b-33

748 B
 748 b-3 • 748 b-4
 748 b-5 • 748 b-6

803 •
 0.4x2.5 • 0.5x3 • 0.6x3.5
 0.8x4 • 1.2x6.5 • 1.2x8

1850 M-22

2105 Lg/9 H •

760-2

803-PH •
 PH 1 • PH 2 • PH 3

2140-50

HAZET No.	d x š mm		EAN-No. 4000896+	€
163-120/24	519x342	24	153572	369,90

163 Sada šroubováků

Hodí se pro HAZET *Assistent* s hloubkou zásuvky 398 mm:
 173 • 179 • 179 N • 179 W • 179 N W • 179 BIG-1 •
 179 XL • 179 N XL • 179 XXL • 179 N XXL • 179 A XXL • 179 T XXL • 180



3/3+		
------	--	--

802 •
 0.6x3.5 • 0.8x4 • 1x5.5
 1.2x6.5 • 1.2x8 • 1.6x10
 2x12

801 NK •
 1x5.5

803-T •
 T 6 • T 7 • T 8 • T 9
 T 10 • T 15 • T 20 • T 25
 T 27 • T 30

802-PH •
 PH 1 • PH 2 • PH 3

801 NK-PH •
 PH 2

2105 Lg/9 H •

HAZET No.	d x š mm		EAN-No. 4000896+	€
163-141/31	519x392	31	151905	236,40





Provozní a dílenské zařízení

Nástrojové moduly



163 Sada šroubováků HEXAnamic®



1/3				
-----	--	--	--	--

802-TH •
 T 10 H • T 15 H • T 20 H
 T 25 H • T 30 H

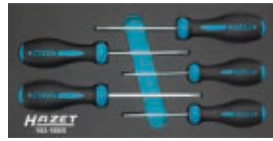

HAZET No.	d x š mm		EAN-No. 4000896+	€
163-185/5	342x172	5	161478	64,75

163 Sada šroubováků TORX®



Hodí se pro HAZET *Assistent* s hloubkou zásuvky 398 mm:
 173 · 179 · 179 N · 179 W · 179 N W · 179 BIG-1 · 179 XL ·
 179 N XL · 179 XXL · 179 N XXL · 179 A XXL · 179 T XXL · 180

1/3+				
------	--	--	--	--

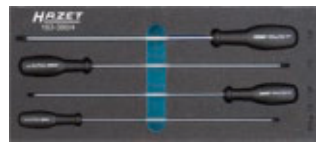

803 LG-T •
 T 15 • T 20 • T 25 • T 30

HAZET No.	d x š mm		EAN-No. 4000896+	€
163-380/4	392x172	4	196814	50,35

163 Sada elektronických šroubováků



Hodí se pro HAZET *Assistent* s hloubkou zásuvky 398 mm:
 173 · 179 · 179 N · 179 W · 179 N W · 179 BIG-1 ·
 179 XL · 179 N XL · 179 XXL · 179 N XXL · 179 A XXL · 179 T XXL · 180

1/3+				
------	--	--	--	--

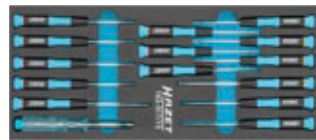

839 •
 0.5x2.8

HAZET No.	d x š mm	l mm	b mm		EAN-No. 4000896+	€
163-517/15	392x172	392	172	15	218745	112,-

163 Sada šroubováků



Hodí se pro HAZET *Assistent* s rozměry zásuvek minimálně
 398 x 694 mm:
 179 XL · 179 N XL · 179 XXL · 179 N XXL
 a 179 A XXL · 179 T XXL do horní zásuvky

4/3+				
------	--	--	--	--



163 Sada šroubováků



801 NK •
 0.6x3.5 · 1x5.5

810 •
 0.4x2.5 · 0.5x3 · 0.8x4
 1x5.5 · 1.2x6.5

810 U-PH •
 PH 1 · PH 2

801 NK-PH •
 PH 1 · PH 2

810-PH •
 PH 0 · PH 1 · PH 2

839 •
 0.5x2.8



805/7 •

810-T •
 T 10 · T 15 · T 20
 T 25 · T 27 · T 30

2105 Lg/9 H •



808/7 •

810 U •
 0.8x4.5 · 1x5.5 · 1.2x7

2116 Lg/8 H •

HAZET No.	d x š mm		EAN-No. 4000896+	€
163-527/56	691x392	56	218691	339,10

Hodí se pro HAZET *Assistent* s hloubkou zásuvky 398 mm:
 173 · 179 · 179 N · 179 W · 179 N W · 179 BIG-1 ·
 179 XL · 179 N XL · 179 XXL · 179 N XXL · 179 A XXL · 179 T XXL · 180



3/3+				
------	--	--	--	--

801 NK •
 0.6x3.5 · 1x5.5

810-PH •
 PH 0 · PH 1 · PH 2

810 U-PH •
 PH 1 · PH 2 · PH 3

801 NK-PH •
 PH 1 · PH 2

810-T •
 T 10 · T 15 · T 20
 T 25 · T 27 · T 30

2105 Lg/9 H •

810 •
 0.4x2.5 · 0.5x3 · 0.8x4
 1x5.5 · 1.2x6.5

810 U •
 0.8x4.5 · 1x5.5 · 1.2x7

2116 Lg/8 H •

HAZET No.	d x š mm		EAN-No. 4000896+	€
163-526/41	519x392	41	218646	255,90

Hodí se pro HAZET *Assistent* s hloubkou zásuvky 398 mm:
 173 · 179 · 179 N · 179 W · 179 N W · 179 BIG-1 · 179 XL ·
 179 N XL · 179 XXL · 179 N XXL · 179 A XXL · 179 T XXL · 180



1/3+				
------	--	--	--	--



801 NK •
 0.6x3.5 · 1x5.5

801 NK-PH •
 PH 1 · PH 2

810 •
 0.5x3 · 0.8x4
 1x5.5 · 1.2x6.5

810-PH •
 PH 1 · PH 2

HAZET No.	d x š mm		EAN-No. 4000896+	€
163-516/10	392x172	10	218738	60,65



163 Sada šroubováků

Hodí se pro HAZET *Asistent* s rozměry zásuvek minimálně 398x694 mm: 179 XL · 179 N XL · 179 XXL · 179 N XXL a 179 A XXL · 179 T XXL do horní zásuvky

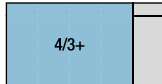

801 NK • 0.6x3.5 · 1x5.5

801 NK-PH • PH 1 · PH 2

802 • 0.8x4 · 1x5.5 · 1.2x6.5
1.2x8 · 1.6x10

802-PH • PH 0 · PH 1 · PH 2 · PH 3

805/7 •

808/7 •

810 • 0.5x3 · 0.8x4
1x5.5 · 1.2x6.5

810-PH • PH 1 · PH 2

810-T • T 10 · T 15 · T 20
T 25 · T 27 · T 30

839 • 0.5x2.8

2105 Lg/9 H •

2116 Lg/8 H •

HAZET No.	d x š mm		EAN-No. 4000896+	€
163-480/57	691x392	57	208234	380,20

Hodí se pro HAZET *Asistent* s hloubkou zásuvky 398 mm: 173 · 179 · 179 N · 179 W · 179 N W · 179 BIG-1 · 179 XL · 179 N XL · 179 N XL · 179 XXL · 179 N XXL · 179 A XXL · 179 T XXL · 180

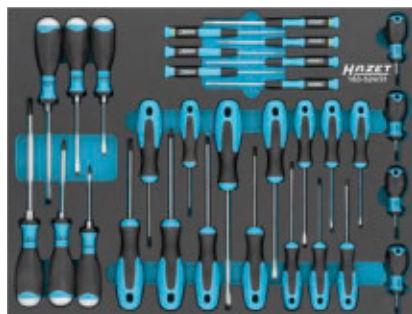
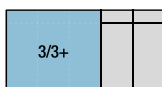

801 NK • 0.6x3.5 · 1x5.5

801 NK-PH • PH 1 · PH 2

805/7 •

810 • 0.4x2.5 · 0.5x3 · 0.8x4
1x5.5 · 1.2x6.5

810-PH • PH 0 · PH 1 · PH 2

810-T • T 10 · T 15 · T 20
T 25 · T 27 · T 30

810 U • 0.8x4.5 · 1x5.5 · 1.2x7

810 U-PH • PH 1 · PH 2 · PH 3

HAZET No.	d x š mm		EAN-No. 4000896+	€
163-524/31	519x392	31	218653	266,20

163 Sada šroubováků TORX®

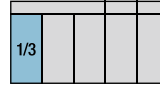

810-T • T 10 · T 15 · T 20
T 25 · T 27 · T 30

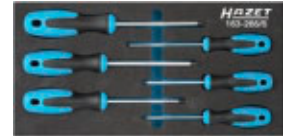

HAZET No.	d x š mm	l mm	b mm		EAN-No. 4000896+	€
163-266/6	342x172	342	172	6	180615	30,75

163 Sada šroubováků s úderovou hlavou

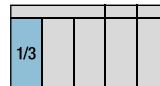

810 U • 0.8x4.5 · 1x5.5 · 1.2x7

810 U-PH • PH 1 · PH 2

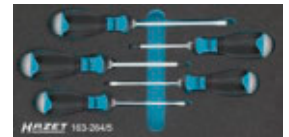

HAZET No.	d x š mm		EAN-No. 4000896+	€
163-264/5	342x172	5	180592	50,35

163 Sada šroubováků

Hodí se pro HAZET *Asistent* s hloubkou zásuvky 398 mm: 173 · 179 · 179 N · 179 W · 179 N W · 179 BIG-1 · 179 XL · 179 N XL · 179 N XL · 179 XXL · 179 A XXL · 179 T XXL · 180

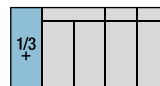

810 U • 0.8x4.5 · 1x5.5 · 1.2x7

810 U-PH • PH 1 · PH 2 · PH 3

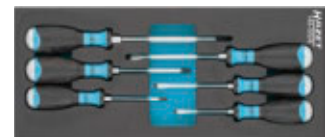

HAZET No.	d x š mm		EAN-No. 4000896+	€
163-522/6	392x172	6	218660	91,45

163 Sada šroubováků s T-rukojetí

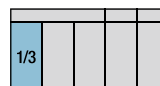

828-T • T 6 · T 7 · T 8
T 9 · T 10 · T 15
T 20 · T 25 · T 30



HAZET No.	d x š mm		EAN-No. 4000896+	€
163-182/9	342x172	9	162352	91,45



Provozní a dílenské zařízení

Nástrojové moduly



163 Sada kleští na hadicové spony

Germany

(E)

1/3				
-----	--	--	--	--



798-3



798-13



798-17

HAZET No.	d x š mm	l mm		EAN-No. 4000896+	€
163-425/3	342x172	342	3	202614	149,-

163 Sada kleští

Germany

(E)

1/3				
-----	--	--	--	--



760-2



1802-22



1841 a-22

HAZET No.	d x š mm		EAN-No. 4000896+	€
163-96/3	342x172	3	145676	128,50

Germany

(E)

Hodí se pro HAZET *Assistant* s hloubkou zásuvky 398 mm:
173 · 179 · 179 N · 179 W · 179 N W · 179 BIG-1 · 179 XL · 179 N XL · 179 XXL · 179 N XXL · 179 A XXL · 179 T XXL · 180

1/3+				
------	--	--	--	--



760-2



1802 M-22



1841 M b-33



1850 M-22

HAZET No.	d x š mm		EAN-No. 4000896+	€
163-511/4	392x172	4	214976	142,90

Germany

(E)

Hodí se pro HAZET *Assistant* s hloubkou zásuvky 398 mm:
173 · 179 · 179 N · 179 W · 179 N W · 179 BIG-1 · 179 XL · 179 N XL · 179 XXL · 179 N XXL · 179 A XXL · 179 T XXL · 180

1/3+				
------	--	--	--	--



1802 M-33



1841 M a-11



1850 M-33



1803 M-11



1841 M b-33

HAZET No.	d x š mm		EAN-No. 4000896+	€
163-375/5	392x172	5	196838	142,90

163 Sada kleští

Germany

(E)

1/3				
-----	--	--	--	--

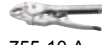

755-10 A



1803 M-11



1802 M-33



1841 M a-11

HAZET No.	d x š mm		EAN-No. 4000896+	€
163-121/4	342x172	4	153541	139,80

163 Sada kleští na pojistné kroužky

Germany

(E)

1/3				
-----	--	--	--	--

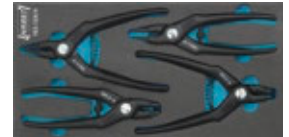

1845 A-19



1845 C-19



1845 B-19



1845 D-19

HAZET No.	d x š mm		EAN-No. 4000896+	€
163-124/4	342x172	4	153602	92,50

163 Sada kleští

Germany

(E)

2/3				
-----	--	--	--	--



757-10



1841 a-22



1846 c-2



760-2



1846 a-2



1846 d-2



1802-22



1846 b-2



1850-22

HAZET No.	d x š mm		EAN-No. 4000896+	€
163-424/9	344x342	9	202546	298,-



163 Sada pilníků

Made in Germany

(E)

1/3				
-----	--	--	--	--



HAZET No.	d x š mm		EAN-No. 4000896+	€
163-426/4	342x172	4	202621	87,35

163 Sada kladiv

Made in Germany

(E)

1/3				
-----	--	--	--	--

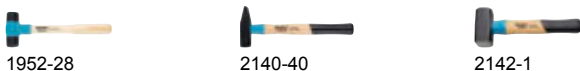

HAZET No.	d x š mm		EAN-No. 4000896+	€
163-464/3	342x172	3	205059	92,50

163 Sada vytloukačů závlaček

Made in Germany

(E)

Hodí se pro HAZET *Assistant* s hloubkou zásuvky 398 mm:
173 · 179 · 179 N · 179 W · 179 N W · 179 N W · 179 BIG-1 · 179 XL · 179 N XL · 179 XXL · 179 N XXL · 179 A XXL · 179 T XXL · 180

1/3+				
------	--	--	--	--



HAZET No.	d x š mm		EAN-No. 4000896+	€
163-510/8	392x172	8	215003	101,80



163 Univerzální sada

Made in Germany

(E)

Hodí se pro HAZET *Assistant* s rozměry zásuvek minimálně 398x694 mm:
179 XL · 179 N XL · 179 XXL · 179 N XXL
a 179 A XXL · 179 T XXL do horní zásuvky

4/3+				
------	--	--	--	--



HAZET No.	d x š mm		EAN-No. 4000896+	€
163-479/26	691x392	26	208104	535,-

Hodí se pro HAZET *Assistant* s hloubkou zásuvky 398 mm:
173 · 179 · 179 N · 179 W · 179 N W · 179 N W · 179 BIG-1 · 179 XL · 179 N XL · 179 XXL · 179 N XXL · 179 A XXL · 179 T XXL · 180

(E)

3/3+				
------	--	--	--	--

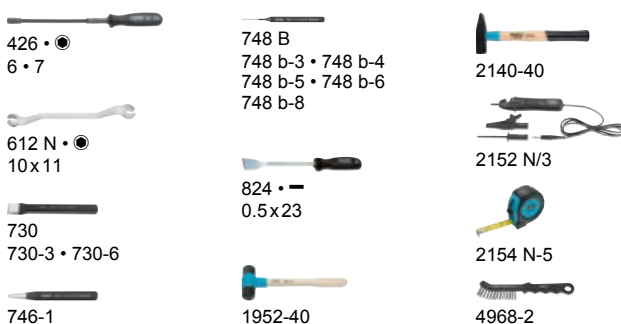

HAZET No.	d x š mm		EAN-No. 4000896+	€
163-143/18	519x392	17	151929	318,60



Provozní a dílenské zařízení

Nástrojové moduly



163 Sada nářadí · úhlových šroubováků · různé nářadí



3/3

730
730-3 · 730-6

1952-35

2140-50

746-1

1976

2147 MS

748 B
748 b-3 · 748 b-4
748 b-5 · 748 b-6

824 · -
0.5x23

2105 Lg/9 H · O

2154-2

HAZET No.	d x š mm		EAN-No. 4000896+	€
163-60/22	519x342	22	122851	303,20

163 Univerzální sada

Made in Germany

Hodí se pro HAZET *Assistent* s hloubkou zásuvky 398 mm:
173 · 179 · 179 N · 179 W · 179 N W · 179 BIG-1 · 179 XL · 179 N XL · 179 XXL · 179 N XXL · 179 A XXL · 179 T XXL · 180



1/3



730-3

748 B
748 b-2 · 748 b-3
748 b-4 · 748 b-5
748 b-6 · 748 b-8

1952-28

740-3

2140-50

746-2

HAZET No.	d x š mm		EAN-No. 4000896+	€
163-523/11	392x172	11	218714	101,80

Hodí se pro HAZET *Assistent* s hloubkou zásuvky 398 mm:
173 · 179 · 179 N · 179 W · 179 N W · 179 BIG-1 · 179 XL · 179 N XL · 179 XXL · 179 N XXL · 179 A XXL · 179 T XXL · 180



3/3+



163 Univerzální sada



612 N · ●
10x11

824 · -
0.5x23

2147 MS

666-5

1952-40

2152 N/3

730
730-3 · 730-6

1976-2

2154 N-5

746-1

1977-2/4

2157-1

748 B
748 b-3 · 748 b-4
748 b-5 · 748 b-6
748 b-8

2140-40

4968-2

HAZET No.	d x š mm		EAN-No. 4000896+	€
163-372/25	519x392	25	196760	369,90

163 Univerzální sada na brzdy

1/3



751 K HS-3

8801 K · O · □^{3/8}
7

2784 · O · □^{3/8}
7

751 K HS-4

986 · O · □^{1/2}
9

2901 G · O · □^{3/8}
7

748 LGB
748 Lg b-3 · 748 Lg b-4

986 LG · O · □^{3/8}
9 · 11

4968-2

810 U-PH · ●
PH 3

2584-8 · O · □^{3/8}
8

4968-6

HAZET No.	d x š mm		EAN-No. 4000896+	€
163-548/14	342x172	14	224197	204,50

163 Sada kleští · s ochrannou izolací

Made in Germany

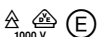

1/3



1802 VDE-22

1804 VDE-33

1860 VDE-11

HAZET No.	d x š mm		EAN-No. 4000896+	€
163-227/3	342x172	3	177868	161,40



163 Sada kleští · s ochrannou izolací

Made in Germany



1/3			
-----	--	--	--



- 759 N-2 VDE 1803 VDE-22 1841 b VDE-33 1850 VDE-22

HAZET No.	d x š mm		EAN-No. 4000896+	€
163-226/4	342x172	4	177875	174,70

163 Sada plochých klíčů, s ochrannou izolací

Made in Germany



Hodí se pro HAZET *Assistant* s hloubkou zásuvky 398 mm:
173 · 179 · 179 N · 179 W · 179 N W · 179 BIG-1 · 179 XL · 179 N XL · 179 XXL · 179 N XXL · 179 A XXL · 179 T XXL · 180



2/3+			
------	--	--	--

- 450 KV · ●
7 · 8 · 9 · 10 · 11 · 12 · 13 · 14 · 15
16 · 17 · 18 · 19 · 22 · 24 · 27 · 30 · 32

HAZET No.	d x š mm	l mm		EAN-No. 4000896+	€
163-542/18	392x344	392	18	223626	562,-

163 Sada očkových klíčů, s ochrannou izolací

Made in Germany



Hodí se pro HAZET *Assistant* s hloubkou zásuvky 398 mm:
173 · 179 · 179 N · 179 W · 179 N W · 179 BIG-1 · 179 XL · 179 N XL · 179 XXL · 179 N XXL · 179 A XXL · 179 T XXL · 180



2/3+			
------	--	--	--

- 630 KV · ●
7 · 8 · 9 · 10 · 11 · 12 · 13 · 14 · 15
16 · 17 · 18 · 19 · 22 · 24 · 27 · 30 · 32

HAZET No.	d x š mm	l mm		EAN-No. 4000896+	€
163-543/18	392x344	392	18	223831	585,-

163 Sada nástrčných klíčů, s ochrannou izolací

Hodí se pro HAZET *Assistant* s hloubkou zásuvky 398 mm:
173 · 179 · 179 N · 179 W · 179 N W · 179 BIG-1 · 179 XL · 179 N XL · 179 XXL · 179 N XXL · 179 A XXL · 179 T XXL · 180



2/3+			
------	--	--	--



- 880 KV · ● · □ 3/8
6 · 7 · 8 · 9 · 10
11 · 12 · 13 · 14 · 16
17 · 18 · 19 · 20 · 22
- 8802 KV · ● · □ 3/8
T 10 · T 15 · T 20
T 25 · T 27 · T 30
T 40 · T 45 · T 50
- 8808 LgKV · ● · □ 3/8
M 8 · M 10 · M 12
- 8816 KV · □ 3/8
- 8801 K-KV · ● · □ 3/8
5 · 6
- 8802 KV-Lg · ● · □ 3/8
T 10 · T 15 · T 20 · T 25
T 30 · T 40 · T 45 · T 50
- 8821 KV · □ 3/8 · □ 3/8
8821 KV-3 · 8821 KV-5

HAZET No.	d x š mm		EAN-No. 4000896+	€
163-545/41	392x344	41	223855	954,-



1/3			
-----	--	--	--



- 880 KV · ● · □ 3/8
- 8816 KV · □ 3/8
- 8821 KV · □ 3/8 · □ 3/8
8821 KV-3 · 8821 KV-5

HAZET No.	d x š mm	l mm		EAN-No. 4000896+	€
163-580/18	342x172	342	18	235520	467,60

Hodí se pro HAZET *Assistant* s hloubkou zásuvky 398 mm:
173 · 179 · 179 N · 179 W · 179 N W · 179 BIG-1 · 179 XL · 179 N XL · 179 XXL · 179 N XXL · 179 A XXL · 179 T XXL · 180



2/3+			
------	--	--	--





Provozní a dílenské zařízení

Nástrojové moduly



163 Sada nástrčných klíčů, s ochrannou izolací



900 KV • • • 1/2
10 • 11 • 12 • 13 • 14
15 • 16 • 17 • 18 • 19
20 • 22 • 23 • 24 • 26
27 • 30 • 32



986 LGKV • • • 1/2
4 • 5 • 6 • 8 • 10



917/918 KV • • • 1/2 • 1/2
917 KV-5 • 918 KV-10



916 KV • • • 1/2

HAZET No.	d x š mm		EAN-No. 4000896+	€
163-544/26	392x344	26	223848	680,-

163 Sada šroubováků • s ochrannou izolací

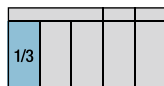

810 VDE • • • •
0.4 x 2.5 • 0.5 x 3 • 0.6 x 3.5 • 0.8 x 4



810 VDE-PH • • • •
PH 1 • PH 2 • PH 3



HAZET No.	d x š mm		EAN-No. 4000896+	€
163-229/7	342x172	7	177844	56,55

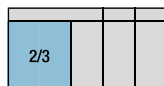

810 VDE • • • •
0.4 x 2.5 • 0.5 x 3
0.6 x 3.5 • 0.8 x 4



810 VDE-T • • • •
T 20 • T 25 • T 30



839 • • •
0.5 x 2.8



810 VDE-PH • • • •
PH 1 • PH 2 • PH 3



2156 VDE-2



HAZET No.	d x š mm		EAN-No. 4000896+	€
163-546/12	344x342	12	223619	101,60

163 Vložka z měkké pěny s přihrádkami na malé díly

Made in Germany

- Safety-Insert-System – veškeré nářadí chráněno proti ořesům
- Chybějícího nářadí si ihned všimnete
- Vhodný pro všechny dílenské vozíky HAZET *Assistant* se zásuvkami
- Pro dílenské vozíky *Assistant* 173 · 179 · 179 N(X) · 179 BIG-1 · 179 XL · 179 N XL · 179 N XXL · 179 W · 179 N W doporučujeme navíc měkké pěnové vložky 163-522x40 resp. 163-522x50

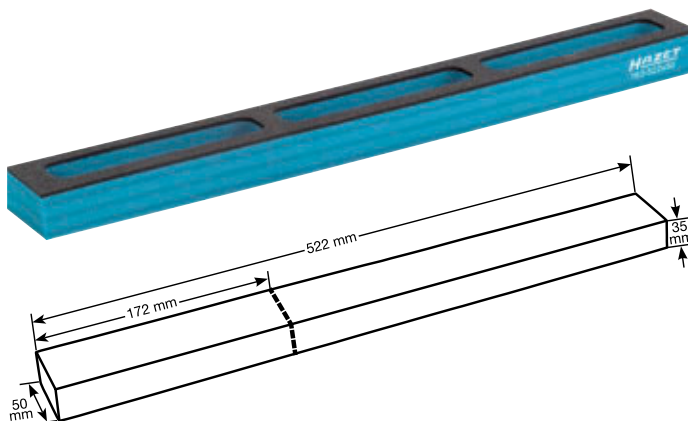

HAZET No.	d x š mm	EAN-No. 4000896+	€
2K-pěnová vložka, prázdná			
163-130 L	342x172	153589	40,70
• 1 přihrádka na drobné součásti • v 33xš 172xh 50 mm • Pro <i>Assistant</i> 173 · 179 · 179 N(X) · 179 BIG-1 · 179 XL · 179 N XL · 179 N XXL · 179 W · 179 N W			
163-172x50	172x50	154692	9,90
• 3 přihrádky na drobné součásti • v 33xš 522xh 50 mm • Pro <i>Assistant</i> 173 · 179 · 179 N(X) · 179 BIG-1 · 179 XL · 179 N XL · 179 N XXL · 179 W · 179 N W			
163-522x50	522x50	141043	17,90

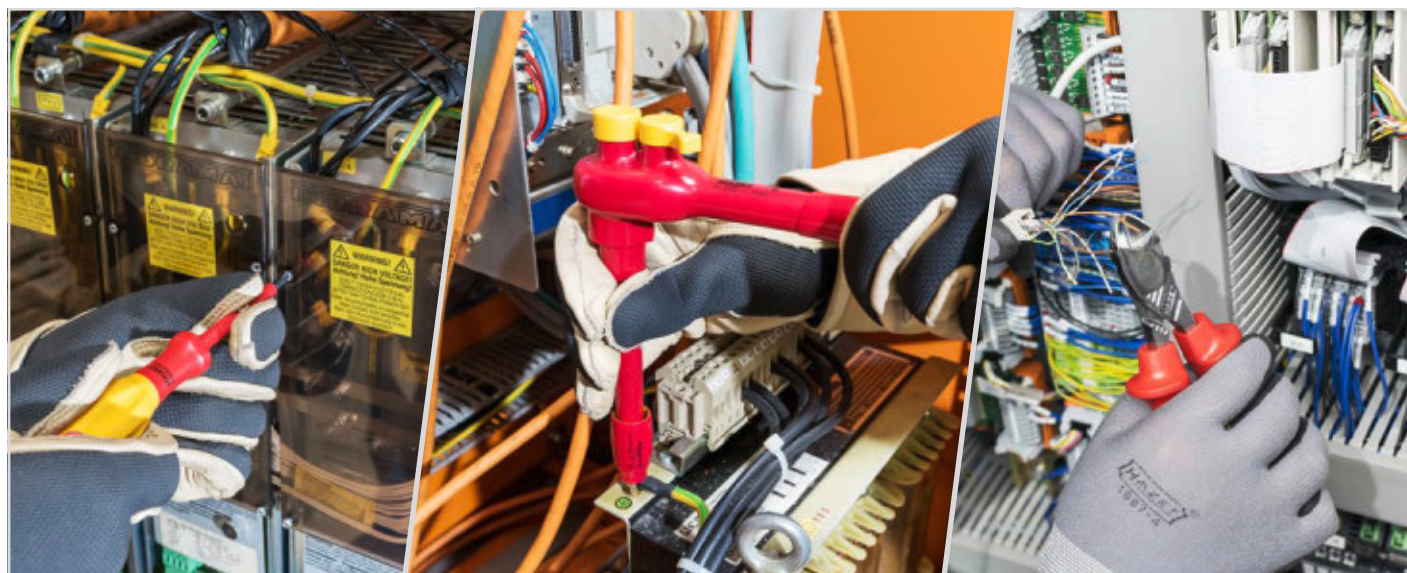





Klíče na šrouby

106–118

Program nástrčných klíčů

119–173

Šroubováky/bity

174–198

Kleště

199–213

Kladiva/sekáče/důlčíky

214–220

Stahovací nářadí

221–230

Brusná, dělicí a obráběcí technika

231–235

Opravy závitů

236–238

Měřicí technika

239–240

Nářadí s ochrannou izolací / elektrikářské nářadí

241–252



Výrobní postup plochého očkového klíče HAZET

- 1 Přířez
- 2 Kování
- 3 Odstranění otřepů
- 4 Tryskání polotovaru
- 5 Frézování hlavy otvoru
- 6 Průtlačné lisování kruhové hlavy
- 7 Broušení (hlava a násada)
- 8 Kalení a popouštění
- 9 Omílání
- 10 Tryskání
- 11 Leštění hlav
- 12 Niklování a chromování

Tolerance klíčů na šrouby

Precizní práce pro přesný jmenovitý rozměr

Tolerance docílená u výrobků HAZET



Přípustná tolerance podle normy DIN

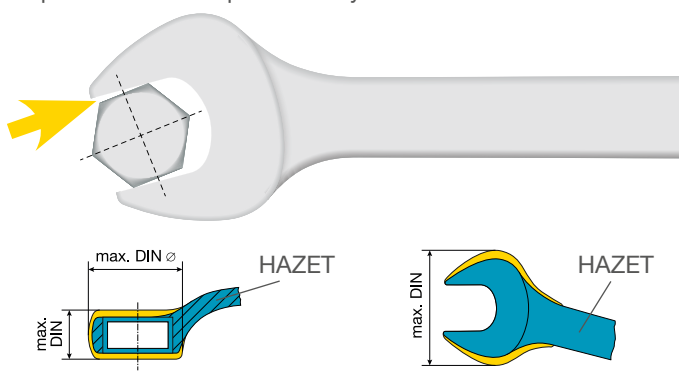

Šroubové klíče HAZET – vysoká přesnost při utahování a povolování šroubových spojů

- Dlouhá životnost pro:
 - vysoce jakostní chrom-vanadiovou ocel
 - zhuštěnou strukturu materiálu kováním v zápustkách
 - pečlivou tepelnou úpravu
 - Správná tvrdost a rozměrová stálost jako garance pro odolnost proti opotřebení a vysokou zatížitelnost
- Optimálně vzájemně sladěný tvar, výrobní rozměry a povrchová úprava zajišťují funkčně vhodnou manipulaci a ergonomické požadavky
- **Štíhlý tvar** zajišťuje pro optimální rozložení materiálu dostatečnou volnost pohybu i na těžko přístupném šroubení
- Hodnoty točivého momentu HAZET jsou pro všechny klíčové otvory výrazně vyšší než požadavky DIN ISO – DIN zde je minimálním požadavkem
- Štíhlý tvar ploché a kruhové hlavy neomezuje zatížitelnost klíče, i když je daleko pod maximálními přípustnými tolerančními mezemi podle DIN ISO



Porovnání Traction profilu HAZET s běžnými šroubovými profily

Traction profil HAZET

Traction profil HAZET je profil bez ostrých hran nebo hrotů, speciálně vyvinutý pro šroubové klíče HAZET. Vysoký a zároveň bezpečný přenos utahovacího momentu je zaručen zajištěnou dosedací plochou Traction profilu v hlavě šroubu. To redukuje vrubový účinek v nářadí na

minimum a chrání hlavu šroubu před poškozením, jako je rohová deformace nebo rohové opotřebení. Dokonce lze dobře a bezpečně ovládat i poškozené šrouby, protože protočení nebo sesmeknutí je téměř vyloučeno.



Šestihran



Dvojitý šestihran

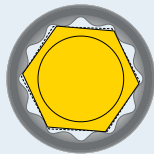
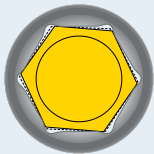

Bezpečný silový záběr díky zajištěné kontaktní ploše (také u šroubů mimo toleranci).

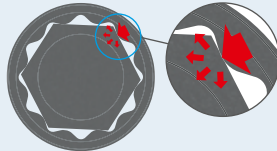
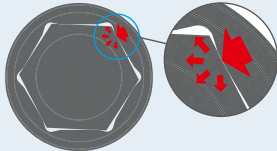

Stejně rozložení sil na strany hlavy šroubu. Žádné otáčení hlavy šroubu díky změněnému bodu záběru.

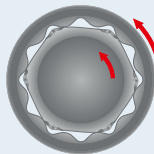
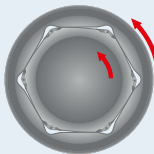

Bezpečné uvolnění i mírně poškozených či opotřebovaných hlav šroubů díky šetrnému přenosu utahovacího momentu. Nedochozí k prokluzování nástroje.

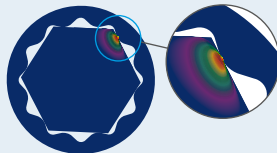
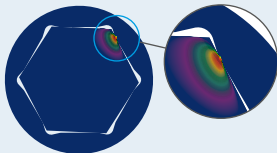

Až o 20 % vyšší utahovací momenty díky optimálnímu silovému záběru.

Konvenční šroubové profily

Šestihran

Dvojitý šestihran

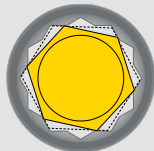
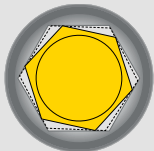

Horší silový záběr v důsledku nezajištěné dosedací plochy. Hrozící sesmeknutí při šroubování může vést k poraněním nebo k poškození součástek. Uťahovací moment nelze již bezpečně aplikovat.

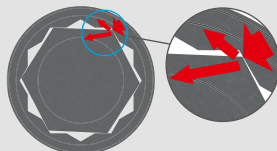
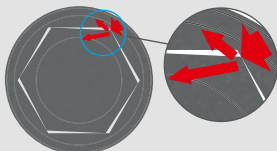

Ostré hrany nebo hroty zvyšují nebezpečí vrubového účinku a mohou v nejhorším případě poškodit nebo zničit šroubovací profil nářadí.

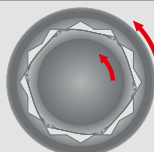
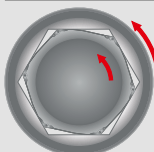

Prokluzování šroubového klíče u poškozených (např. protočených) hlav šroubů ztěžuje, popř. znemožňuje uvolnění. Tím se znemožní dobrý přenos požadovaného utahovacího momentu.

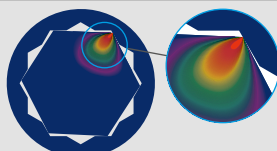
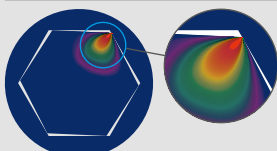

Silový záběr působí hlavně na hrot šroubového profilu. Toto bodové zatížení vede k poškození profilu hlavy šroubu.



Přehled šroubových klíčů HAZET

Který šroubový klíč v jaké velikosti

Produktová skupina	Označení	Provedení	Velikost klíče			jako sada	
			metricky mm	palce "	TORX®		
	279	Jednostranný klíč, nastavitelný	• Se stupnicí	13 – 53	0.5 – 2.1		112
	440	Dvojitě ploché klíče	• Kovaný • Krátké a tenké provedení	3.2 – 14		440/14 P	112
	450 N	Dvojitě ploché klíče	• Úzké hlavy • Dřík s velmi stabilním dvojitým T-profilem HAZET	4 x 5 – 46 x 50	1/4 x 5/16 – 1.1/16 x 1.1/4	450 N/10 450 N/12 450 N/8 RS 450 N/12 N RS 163-95/8	111
	600 N (A)	Očkoploché klíče	• Dlouhé a úzké provedení • Úzké hlavy • Dřík s velmi stabilním dvojitým T-profilem HAZET	5.5 – 80	1/4 – 1.1/2	600 N/12 N 600 N/17 N 600 N/21 600 N/30 163-98/17 163-292/8 600 N A/10 600 N A/12-1	112
	600 Lg	Očkoplochý klíč, extra dlouhý	• Minimálně o 25 % delší než srovnatelný standardní klíč • Lepší přístupnost k hluboko ležícím šroubovým spojům	10 – 41		600 Lg/8 600 Lg/10 600 Lg/12 600 Lg/13	114
	603	Očkoploché klíče	• Hlava očkového klíče zahnutá o 10°	5.5 – 32		603/17 N 603/17 H 163-99/18	114
	606	Ráčnový očkoplochý klíč	• K manipulaci s těžko přístupnými šroubovými spoji v těsném prostoru	8 – 32		606 N/12 606 N/6 606/6-1 163-366/18 163-186/16 606/4 SPC 163-97/6	115
	610 N	Dvojitý očkový klíč	• Ergonomicky tvarovaný, přesazené hlavy	6 x 7 – 30 x 34		610 N/8 610 N/8 RS 610 N/12 RS	116
	630 (A)	Dvojitý očkový klíč	• Hluboce zalomený • Tenkostěnné hlavy	6 x 7 – 36 x 41	1/4 x 5/16 – 1.1/16 x 1.1/4	630/8 630/12 163-101/9 163-296/7	117
	612 (N)	Oboustranný očkový maticový klíč (otevřený)	• Pro šroubení trubek, převlečné matice a šrouby	8 x 10 – 30 x 32			118
	609	Oboustranný očkový klíč TORX®	• Přímé provedení			E6 x E8 – E20 x E24	118
	848 Z	Očkový klíč, dvojitý šestihran, otevřený		17 – 27			139
				30 – 46			151



Věděli jste to?



Nástroje HAZET mají sofistikované povrchy

Proč matné chromování?

- Je to bezpečné chromování, protože optimálně přilne na ocel
- Drsný povrch, bezpečně uchopitelný i špinavýma rukama
- Antireflexní povrch
- Působí ušlechtilé a decentně
- Dvojitá ochrana proti korozi



Utahovací momenty

Velikost šroubu	Třída jakosti	3.6	5.6	6.9	8.8	10.9	12.9	Minimální zkušební utahovací moment	
Závit	SW	Nm	Nm	Nm	Nm	Nm	Nm	Očko podle DIN řady A	Plochý podle DIN řady A
M6	10	3	4	8	10	14	17	58,1	24,8
M7	11	5	7	14	17	24	28	72,7	32,3
M8	13	8	10	21	25	35	42	107	51,6
M10	17	16	21	42	50	70	85	201	109
M12	19	28	38	73	87	122	147	261	149
M14	22	45	60	116	138	194	235	368	225
M16	24	59	93	178	210	299	357	451	287
M18	27	95	127	245	289	411	490	594	399
M20	30	135	180	348	411	578	696	760	536
M22	32	182	245	470	558	784	941	884	642
M24	36	230	308	598	710	1000	1196	1165	894
M27	41	343	460	887	1049	1480	1480	1579	1154
M30	46	465	622	1206	1421	2010	2402	2067	1453
M33	50	632	848	1627	1931	2716	3265	2515	1716
M36	55	813	1088	2098	2481	3491	4197	3140	2077
M39	60	1059	1412	2716	3226	4530	5442	3849	2471
M42	65	1304	1745	3363	3991	5609	6727	4021	2900
M45	70	1637	2177	4207	4991	7011	8414	4658	3364



Nářadí – pro dobrou práci.

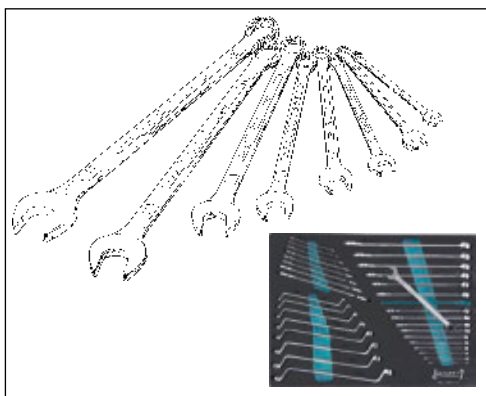

Od firmy HAZET!





Ruční nářadí

Klíče na šrouby



450 N Oboustranné ploché klíče

Made in Germany

- Štíhlé hlavy
- Dřík s extra stabilním dvojitým T-profillem HAZET
- Poloha klíče: 15°
- Povrch: chromováno
- DIN 3110, ISO 10102

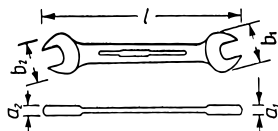

* = Mimo řady DIN

HAZET No.	l mm	a mm	b ₁ mm	b ₂ mm	EAN-No. 4000896+	€
450 N- 4x5 *	99,5	3,2	11,4	13,2	020683	5,35
450 N- 5x5.5 *	99,6	3,6	13,4	15,1	020706	5,90
450 N- 6x7	121,3	3,5	15,1	17,1	020713	5,35
450 N- 8x9	139	3,8	18,5	21	020744	5,35
450 N- 8x10	140,1	4,1	19	23,2	020737	5,70
450 N-10x11	155,7	4,6	23,2	25,2	020355	5,55
450 N-10x13	172	5,1	25,1	29,9	020362	9,05
450 N-12x13	172,7	5,1	27,1	29,1	020386	7,10
450 N-13x17	205,5	6	29,3	36	020423	9,05
450 N-14x15	187,8	5,7	30,9	32,8	020430	7,35
450 N-16x17	205,7	6	34,8	37	020454	8,15
450 N-16x18	205,7	6	34,8	38,3	020461	9,90
450 N-17x19	220,9	6,7	37,4	40,6	020478	8,80
450 N-18x19	221,2	6,7	38,6	40,6	020485	8,80
450 N-20x22 *	238,9	7	43,9	47,8	020515	10,70
450 N-21x22	238	7	44,8	46,8	020522	11,70
450 N-21x23 *	246	7,1	44,8	48,8	020539	11,70
450 N-22x24	254,6	7,1	47,8	51,9	020553	15,-
450 N-24x26 *	269,4	7,8	50,9	54,9	020560	13,05
450 N-24x27	269	7,8	50,9	57	020577	14,05
450 N-25x28 *	284,2	8,4	53,4	59	020584	15,25
450 N-27x32	303,8	9,1	58	67,3	020607	18,05
450 N-30x32	303,4	9	63,4	67,3	020614	18,05
450 N-32x36	343,2	10,1	66,9	75,2	020638	34,05
450 N-34x36	343,2	10,1	67,9	74,5	020645	34,05
450 N-36x41	396,7	10,5	74,6	81,1	020652	42,25
450 N-41x46	439,5	11,4	85,5	94,4	020669	60,45
450 N-46x50	498	12,3	94,3	102,2	020676	78,70

450 N Sada oboustranných plochých klíčů

Made in Germany

- Vhodné pro upevnění na stěnu
- Plastový svírací držák
- Povrch: chromováno
- DIN 3110, ISO 10102



HAZET No.	d x š x v mm		EAN-No. 4000896+	€
450 N • ●	6x7 • 8x9 • 10x11 • 12x13 • 14x15 • 16x17 • 18x19 • 21x22			
450 N/8 RS	260x110x55	8	020867	74,70
• S držadlem				
450 N • ●	6x7 • 8x9 • 10x11 • 12x13 • 14x15 • 16x17 • 18x19 • 20x22 • 21x23 • 24x27 • 25x28 • 30x32			
450 N/12 N RS	340x165x75	12	020805	152,40

Made in Germany

- Safety-Insert-System, 2komponentní vložka z měkké pěny.
- Vložka vhodná také pro HAZET-Assistent

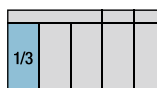

HAZET No.	d x š mm		EAN-No. 4000896+	€
450 N • ●	6x7 • 8x9 • 10x11 • 12x13 • 14x15 • 16x17 • 18x19 • 21x22			
163-95/8	342x172	8	145669	70,90
Hodí se pro HAZET Assistent s hloubkou zásuvky 398 mm: 173 • 179 • 179 N • 179 W • 179 N W • 179 BIG-1 • 179 XL • 179 N XL • 179 XXL • 179 N XXL • 179 A XXL • 179 T XXL • 180				
450 • ●	6x7 • 8x9 • 10x11 • 12x13 • 14x15 • 16x18 • 17x19 • 20x22 • 21x23 • 24x27 • 30x32 • 34x36			
163-519/12	392x172	12	218684	132,60

450 N Sada oboustranných plochých klíčů

Made in Germany

- Povrch: chromováno
- DIN 3110, ISO 10102



Made in Germany

- Štíhlé hlavy
- Dřík s extra stabilním dvojitým T-profillem HAZET
- Poloha klíče: 15°
- Americké rozměry
- Povrch: chromováno
- DIN 895

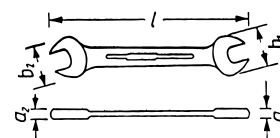

HAZET No.		EAN-No. 4000896+	€
450 N • ●	6x7 • 8x9 • 10x11 • 12x13 • 14x15 • 16x17 • 18x19 • 21x22 • 24x26 • 27x32		
450 N/10	10	020751	88,25
450 N • ●	6x7 • 8x9 • 10x11 • 12x13 • 14x15 • 16x17 • 18x19 • 20x22 • 21x23 • 24x26 • 25x28 • 27x32		
450 N/12	12	020775	114,10

HAZET No.	l mm	a mm	b ₁ mm	b ₂ mm	EAN-No. 4000896+	€
450 N A-1/4x5/16 VKH	129,9	3	17,1	18,5	020911	7,05
450 N A-3/16x3/8 VKH	140,1	4,1	19	23,2	020973	8,25
450 N A-3/8x7/16 VKH	155,7	4,6	23,2	25,2	020966	8,95
450 N A-1/2x1/2 VKH	172,4	5,1	30,1	31	020904	10,70
450 N A-9/16x5/8 VKH	189,8	5,7	32,4	35,4	021000	12,45
450 N A-19/32x11/16 VKH	205,7	6	34,8	38,3	020935	13,20
450 N A-5/8x3/4 VKH	220,9	6,7	37,4	40,6	020980	14,85
450 N A-29/32x7/8 VKH	238,9	7	43,9	47,8	020959	17,25
450 N A-7/8x15/16 VKH	254,6	7,1	47,8	51,9	020997	20,25
450 N A-19/16x1 VKH	269,4	7,8	50,9	54,9	020928	21,45
450 N A-1x1 1/8 VKH	284,2	8,4	53,4	59	020942	22,25
450 N A-1 1/16x1 1/4 VKH	303,8	9	58	67,3	020881	26,45



440 Oboustranné ploché klíče

Made in Germany

- Kované provedení
- Stejně velikosti klíčů
- Krátké, tenké provedení
- Poloha klíče: 15° x 75°
- Povrch: chromováno

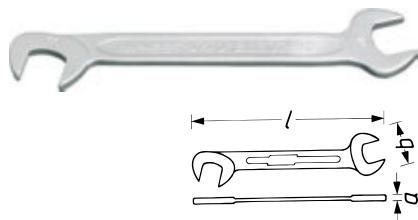

HAZET No.	l mm	a mm	b mm	EAN-No. 4000896+	€
440- 3.2	70	2	10,5	020119	10,20
440- 3.5	70	2	10,5	020126	10,20
440- 4	70	2	10,5	020133	10,20
440- 4.5	70	2	10,5	020140	10,20
440- 5	78	2	12,6	020157	10,20
440- 5.5	78	2	12,6	020164	10,20
440- 6	78	2	12,6	020171	10,20
440- 7	91	2	14,7	020188	10,20
440- 8	96	3	16,8	020195	10,20
440-10	105	3	21	020065	10,20
440-11	116	3	24,2	020072	10,55
440-12	116	3	24,2	020089	11,80
440-13	131	3	28,3	020096	11,20
440-14	131	3	28,3	020102	13,75

440 Sada dvojitých plochých klíčů

Made in Germany

- Plastová taška

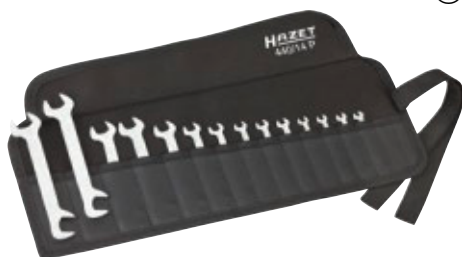

440 • ●
3.2 • 3.5 • 4 • 4.5 • 5 • 5.5
6 • 7 • 8 • 10 • 11 • 12 • 13 • 14

HAZET No.	ks	EAN-No. 4000896+	€
440/14 P	14	178759	166,50

279 Jednostranný klíč · nastavitelný

Přestavitelný klíč

- Se stupnicí
- Poloha klíče: 15°
- Povrch: fosfátováno, zrcátko leštěno
- ISO 6787

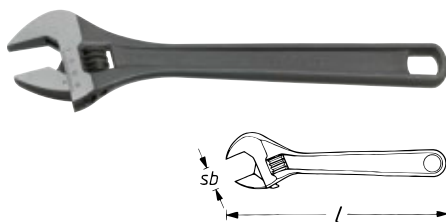

HAZET No.	l mm	sb mm	EAN-No. 4000896+	€
279- 4	109	13	018086	24,90
279- 6	158	18	018093	27,90
279- 8	205	23	018109	30,90
279-10	255	28	018048	41,-
279-12	308	34	018055	57,10
279-15	382	43	018062	88,35
279-18	458	53	018079	149,90

600 N Očkoploché klíče

Made in Germany

- Dlouhé štíhlé provedení
- Štíhlé hlavy
- Dřík s extra stabilním dvojitým T-profilem HAZET
- Hlava očkového klíče zahnutá o 15°
- Povrch: chromováno, leštěná hlava
- DIN 3113 tvar A, ISO 3318, ISO 7738

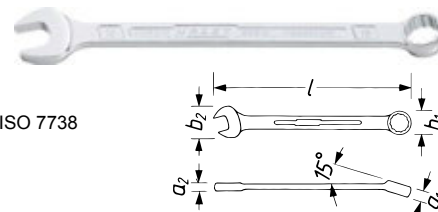

* = Mimo řady DIN

HAZET No.	l mm	a ₁ mm	a ₂ mm	b ₁ mm	b ₂ mm	EAN-No. 4000896+	€
600 N- 5.5 *	105	6	4	9,6	15,5	023288	8,65
600 N- 6	105	6	4	9,6	15,5	023295	8,55
600 N- 7	118,5	6,6	4	10,9	17,5	023301	8,55
600 N- 8	130	7	4,5	12	18,5	023318	8,50
600 N- 9	143	8	4,5	13,7	21	023325	10,35
600 N-10	154,5	8	5	15	23	023028	9,70
600 N-11	168,5	8,4	5,5	15,9	25,5	023035	11,70
600 N-12	180,5	9	5,5	17,8	27,5	023042	13,10
600 N-13	193	10	6,3	19	29	023059	12,10
600 N-14	204,5	10	6,5	20,1	31	023073	14,-
600 N-15	218	11	7	21,4	32,5	023080	15,60
600 N-16	230,5	11,4	7	23,1	35	023097	15,95
600 N-17	242,5	12,4	7,5	24,5	37	023103	15,10
600 N-18	255	13	8	26	39	023110	18,35
600 N-19	268,5	13,5	8	27,5	41	023127	17,05
600 N-20 *	279,5	13,5	8,5	29	43	023134	22,15
600 N-21	292	13,7	8,5	30	45	023141	21,60
600 N-22	304,5	14	8,5	31,5	47	023158	23,30
600 N-23 *	328	14,3	9,5	33	49	023165	27,45
600 N-24	328	14,7	9,5	34,5	51	023172	26,65
600 N-25 *	354	15	10	36	53,5	023189	31,-
600 N-26 *	354	15,5	10	37,5	55	023196	31,-
600 N-27	380	16	10,5	39	57	023202	30,60
600 N-28 *	380	16,5	11	40,5	59	023219	37,50
600 N-29 *	380	17	11,5	41,5	60	023226	37,50
600 N-30	405,5	17,5	12,2	43	63	023233	42,60
600 N-32	420	18	12	45,5	66,5	023240	43,25
600 N-34	432	19	13	48,5	67	023257	46,75
600 N-36	460	20	13	51,8	75	023264	54,80
600 N-41	500	20,6	14	58,8	85	023271	68,05

* = Mimo řady DIN

HAZET No.	l mm	a ₁ mm	a ₂ mm	b ₁ mm	b ₂ mm	EAN-No. 4000896+	€
• Hlava očkového klíče zakřivená v úhlu 10°							
• DIN 3113 tvar B, ISO 3318, ISO 7738							
600 N-46	520	24	15	69	95	048564	163,20
600 N-50	560	26	16,5	75	103	048571	197,90
600 N-55	610	28	18	84,5	113	048588	272,20
600 N-60	660	31	20	90	123	048595	370,30
600 N-65 *	710	33	22	98	133	048601	451,70
600 N-70 *	760	35	24	105	143	048618	463,-
600 N-75 *	810	38	26	110	153	048625	519,-
600 N-80 *	860	41	28	119	163	048632	648,-

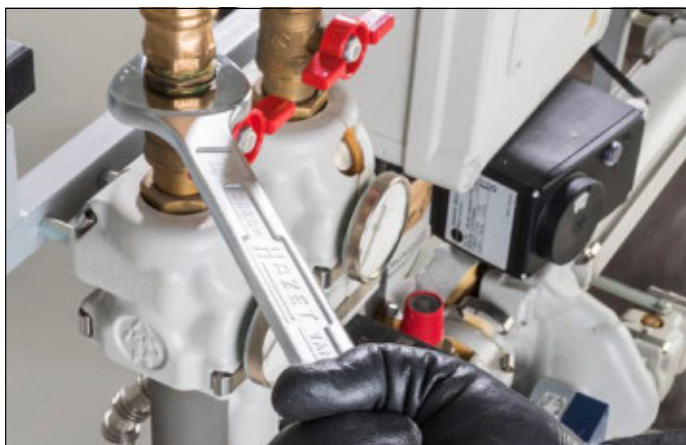



Ruční nářadí

Klíče na šrouby



600 N Sada očkoplochých klíčů

Made in Germany

- Povrch: chromováno, leštěná hlava
- DIN 3113 tvar A, ISO 3318, ISO 7738



HAZET No.		EAN-No. 4000896+	€
600 N •	10 • 11 • 12 • 13 • 14 • 15 • 16 • 17 • 18 • 19 • 21 • 22		
600 N/12 N	12	023332	186,20
600 N •	7 • 8 • 9 • 10 • 11 • 12 • 13 • 14 • 15 • 16 • 17 • 18 • 19 • 21 • 22 • 24 • 27		
600 N/17 N	17	023349	270,30
600 N •	6 • 7 • 8 • 9 • 10 • 11 • 12 • 13 • 14 • 15 • 16 • 17 • 18 • 19 • 21 • 22 • 24 • 27 • 30 • 32 • 34		
600 N/21	21	023356	410,60
600 N •	5.5 • 6 • 7 • 8 • 9 • 10 • 11 • 12 • 13 • 14 • 15 • 16 • 17 • 18 • 19 • 20 • 21 • 22 • 23 • 24 • 25 • 26 • 27 • 28 • 29 • 30 • 32 • 34 • 36 • 41		
600 N/30	30	023363	728,-

600 N Sada nářadí v systému bezpečného uložení

Made in Germany

- Safety-Insert-System, 2komponentní vložka z měkké pěny.
- Vložka vhodná také pro HAZET-Assistent



2/3				
-----	--	--	--	--

HAZET No.	d x š mm		EAN-No. 4000896+	€
600 N •	6 • 7 • 8 • 9 • 10 • 11 • 12 • 13 • 14 • 15 • 16 • 17 • 18 • 19 • 21 • 22 • 24			
163-98/17	344x342	17	145690	277,50

Made in Germany

- Safety-Insert-System, 2komponentní vložka z měkké pěny.
- Vložka vhodná také pro HAZET-Assistent



1/3				
-----	--	--	--	--

HAZET No.	d x š mm		EAN-No. 4000896+	€
600 N •	10 • 11 • 13 • 14 • 15 • 17 • 19 • 22			
163-292/8	342x172	8	186372	115,10

600 NA Očkoploché klíče

Made in Germany

- Dlouhé štíhlé provedení
- Štíhlé hlavy
- Dřík s extra stabilním dvojitým T-profilem HAZET
- Hlava očkového klíče zahnutá o 15°
- Americké rozměry
- Povrch: chromováno

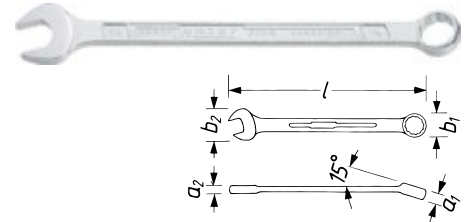

HAZET No.	l mm	a ₁ mm	a ₂ mm	b ₁ mm	b ₂ mm	EAN-No. 4000896+	€
600 N A-1/4	105	6	4	9,6	15,1	023493	8,80
600 N A-5/16	130	7	4,5	12	18,3	023554	8,95
600 N A-3/8	154,5	8	5	15	23,1	023547	11,-
600 N A-7/16	168,5	8,4	5,5	15,9	25,3	023578	11,70
600 N A-1/2	193	10	6,3	19	29,1	023486	14,05
600 N A-9/16	204,5	10	6,5	20	30,9	023592	14,20
600 N A-5/8	230	11,4	7	23,1	34,7	023561	15,95
600 N A-11/16	242,5	12,4	7,5	25	36,6	023509	18,40
600 N A-3/4	268	13,5	8	27,5	40,6	023530	19,35
600 N A-13/16	292	13,7	8,5	30	44,6	023516	21,90
600 N A-7/8	304	14	8,5	31,5	46,8	023585	23,30
600 N A-15/16	328	14,7	9,5	34,5	50,7	023523	26,90
600 N A-1	354	15,5	10	37,5	54,7	023400	30,45
600 N A-1 1/8	380	17	11,5	41,5	59,7	023448	36,45
600 N A-1 1/4	420	18	12	45,2	66,4	023431	43,70
600 N A-1 5/16	432	19	13	48,5	66,7	023462	45,-
600 N A-1 1/2	486	20,5	13,7	54,7	77,1	023424	55,55

600 NA Sada očkoplochých klíčů

Made in Germany

- Dlouhé štíhlé provedení
- Štíhlé hlavy
- Dřík s extra stabilním dvojitým T-profilem HAZET
- Hlava očkového klíče zahnutá o 15°
- Americké rozměry
- Povrch: chromováno



HAZET No.		EAN-No. 4000896+	€
600 NA •	1/4 • 5/16 • 3/8 • 7/16 • 1/2 • 9/16 • 5/8 • 3/4 • 7/8 • 1		
600 N A/10	10	023608	156,60
600 NA •	1/4 • 5/16 • 3/8 • 7/16 • 1/2 • 9/16 • 5/8 • 3/4 • 7/8 • 1 • 1 1/8 • 1 1/4		
600 N A/12-1	12	023615	237,80





600 LG Očkoplochý klíč · extra dlouhý

Made in Germany

• Zatížitelnost minimálně dvakrát vyšší než DIN

- Minimálně o 25 % delší než srovnatelný standardní klíč – pro větší přenos síly
- Lepší přístupnost u hluboko uložených šroubení
- Dřík s extra stabilním dvojitým T-profilem štíhlý tvar
- Povrch: chromováno

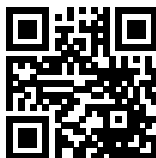

YouTube Clip

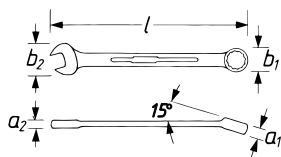
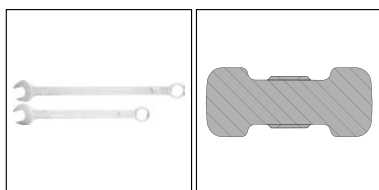

HAZET No.	l mm	a ₁ mm	a ₂ mm	b ₁ mm	b ₂ mm	EAN-No. 4000896+	€
600 Lg-10	210	8,5	5,5	16,5	23,1	197644	11,80
600 Lg-11	220	9	5,5	18	25,1	199518	13,-
600 Lg-12	230	9,5	6	19,5	27	199501	13,35
600 Lg-13	245	10	6	20,8	29,1	198238	14,45
600 Lg-14	255	11	6,5	22,5	30,9	197651	15,05
600 Lg-15	270	11,6	7	23,8	32,6	209958	16,95
600 Lg-16	290	12	7	25,2	34,7	209200	19,85
600 Lg-17	305	12,5	7,5	26,5	36,6	197668	22,25
600 Lg-18	320	13,8	8	28	38,6	209194	22,95
600 Lg-19	335	15	8,5	29,5	40,6	198245	24,-
600 Lg-21	365	15,8	8,5	32	44,6	209965	25,45
600 Lg-22	380	16	9	33,7	46,8	199525	27,05
600 Lg-24	430	18	10	36,5	50,7	198252	32,40
600 Lg-27	480	20	11	40,5	56,6	198269	37,70
600 Lg-30	510	21	12	45,1	63,1	199723	46,60
600 Lg-32	530	21,5	12	47,6	66,4	197675	52,65
600 Lg-36	580	24	13	53	74,6	205745	61,50
600 Lg-41	600	26	14	60,4	84,9	205738	77,60

Made in Germany

• Zatížitelnost minimálně dvakrát vyšší než DIN

- Minimálně o 25 % delší než srovnatelný standardní klíč – pro větší přenos síly
- Lepší přístupnost u hluboko uložených šroubení
- Dřík s extra stabilním dvojitým T-profilem štíhlý tvar
- Povrch: chromováno

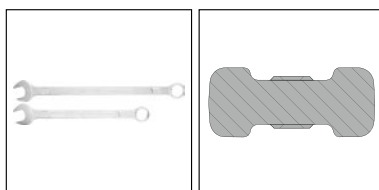

YouTube Clip

600 LG Očkoplochý klíč · extra dlouhý

HAZET No.		EAN-No. 4000896+	€
600 LG •	10 • 13 • 14 • 17 • 19 • 24 • 27 • 32		
600 Lg/8	8	199938	205,50
600 LG •	10 • 11 • 12 • 13 • 14 • 15 • 16 • 17 • 18 • 19		
600 Lg/10	10	218424	167,70
600 LG •	10 • 11 • 12 • 13 • 14 • 17 • 19 • 22 • 24 • 27 • 30 • 32		
600 Lg/12	12	202492	282,10
600 LG •	10 • 11 • 12 • 13 • 14 • 15 • 16 • 17 • 18 • 19 • 21 • 22 • 24		
600 Lg/13	13	218417	243,30

603 Očkoploché klíče

Made in Germany

- Hlava očkového klíče zakřivená v úhlu 10°
- Poloha klíče: 15°
- Povrch: chromováno
- DIN 3113 tvar B, ISO 3318, ISO 7738

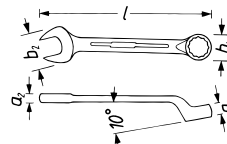

+ = hlava očkového klíče s 6hranem
* = 603-5,5 mimo řadu DIN

HAZET No.	l mm	a ₁ mm	a ₂ mm	b ₁ mm	b ₂ mm	EAN-No. 4000896+	€
603- 5.5 + *	90	4,7	3,7	9,8	14,1	023929	9,35
603- 6 +	100	5,1	4	10,5	14,9	023950	9,35
603- 7 +	110	5,5	4,3	12,2	16,8	023981	9,35
603- 8 +	120	5,9	4,5	13,1	18,3	024018	8,90
603- 9 +	130	6,3	4,5	14,6	21	024025	9,35
603-10	137	6,7	5	15,6	23	023691	8,90
603-11	145	7,1	5,2	17,1	25	023714	10,05
603-12	152	7,6	5,4	18,4	26,8	023721	10,70
603-13	160	8	5,6	19,9	28,8	023738	10,90
603-14	170	8,5	5,8	21,4	30,7	023752	11,60
603-15	180	9	6	22,5	32,6	023769	12,-
603-16	190	9,5	6,2	24	34,6	023776	12,20
603-17	200	10	6,4	25,5	36,5	023783	13,25
603-18	210	10,5	6,7	26,9	38,6	023790	16,95
603-19	220	11	7	28,4	40,6	023806	16,15
603-21	240	12	7,6	30,7	44,8	023820	18,50
603-22	250	12,5	7,9	32,2	46,8	023837	21,35
603-24	270	13,5	8,5	35,1	51	023844	23,10
603-27	305	15	9,3	38,5	57,3	023868	28,05
603-30	340	16	10	42,7	63,4	050260	34,95
603-32	360	17	10,5	45,5	67,2	023882	34,95

603 Sada očkoplochých klíčů

Made in Germany

- Povrch: chromováno
- DIN 3113 tvar B, ISO 3318, ISO 7738



HAZET No.		EAN-No. 4000896+	€
603 •	7 • 8 • 9 • 10 • 11 • 12 • 13 • 14 • 15 • 16 • 17 • 18 • 19 • 21 • 22 • 24 • 27		
603/17 N	17	024063	239,50



Ruční nářadí

Klíče na šrouby



603 Sada očkoplochých klíčů

● **Made in Germany**

- Povrch: chromováno
- DIN 3113 tvar B, ISO 3318, ISO 7738



HAZET No.		EAN-No. 4000896+	€
603 ●			
6 • 7 • 8 • 9 • 10 • 11 • 12 • 13 • 14 • 15 • 16 • 17 • 18 • 19 • 21 • 22 • 24			
603/17 H	17	024049	237,40

● **Made in Germany**

- Safety-Insert-System, 2komponentní vložka z měkké pěny.
- Vložka vhodná také pro HAZET-Assistent



2/3			
-----	--	--	--

HAZET No.	$d \times \check{s}$ mm		EAN-No. 4000896+	€
603 ●				
6 • 7 • 8 • 9 • 10 • 11 • 12 • 13 • 14 • 15 • 16 • 17 • 18 • 19 • 21 • 22 • 24 • 27				
163-99/18	344x342	18	145706	272,30

606 Ráčnový očkoplochý klíč

- Manipulace s těžko přístupnými šroubovými spoji v těsném prostoru, bez nutnosti přestavění klíče díky ráčnové funkci



- Dlouhé, štíhlé provedení
- Dřík s extra stabilním dvojitým T-profilem HAZET
- Očkový klíč s přepínatelnou ráčnovou funkcí
- S jemným ozubením, 72 zubů, 5° úhel otáčení s 8 a 9 mm: 60 zubů, úhel otáčení 6°
- Očko zahnuté v úhlu 13°
- Poloha klíče: 15°
- Povrch: chromováno

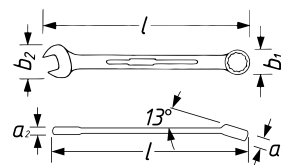

HAZET No.	l mm	a_1 mm	a_2 mm	b_1 mm	b_2 mm	EAN-No. 4000896+	€
606- 8	129,9	6,8	4,9	16,8	16,7	100941	21,65
606- 9	143	7,2	5,2	18,5	18,8	100958	21,65
606-10	154,5	7,6	5,6	20,1	20,9	100965	22,35
606-11	168,6	8	6	21,7	23	100972	23,35
606-12	180,3	8,5	6,4	22,9	25,9	100989	24,60
606-13	193,2	8,9	6,7	24,9	27,2	100996	26,20
606-14	204,6	9,3	7,1	27,2	29,3	101009	27,20
606-15	218	9,7	7,4	28,6	31,3	101016	28,40
606-16	230,2	10,2	7,7	30,1	33,4	101023	29,60
606-17	242,2	10,6	8,1	32	35,5	101030	30,75
606-18	255	11	8,5	32,9	37,6	101047	32,85
606-19	268,3	11,5	9,1	34,1	39,7	101054	32,85
606-21	291,5	13,3	12	44,3	48,3	151233	48,30
606-22	291,5	13,3	12	44,3	48,3	151028	48,30
606-24	333,1	14,8	12,5	51,2	53,5	151011	60,95
606-27	359,2	15,8	14,7	54,9	60,2	151004	81,85
606-30	402,5	17,3	15,2	60,8	67	150991	96,85
606-32	425,8	17,8	15,7	64,2	71	150984	111,20

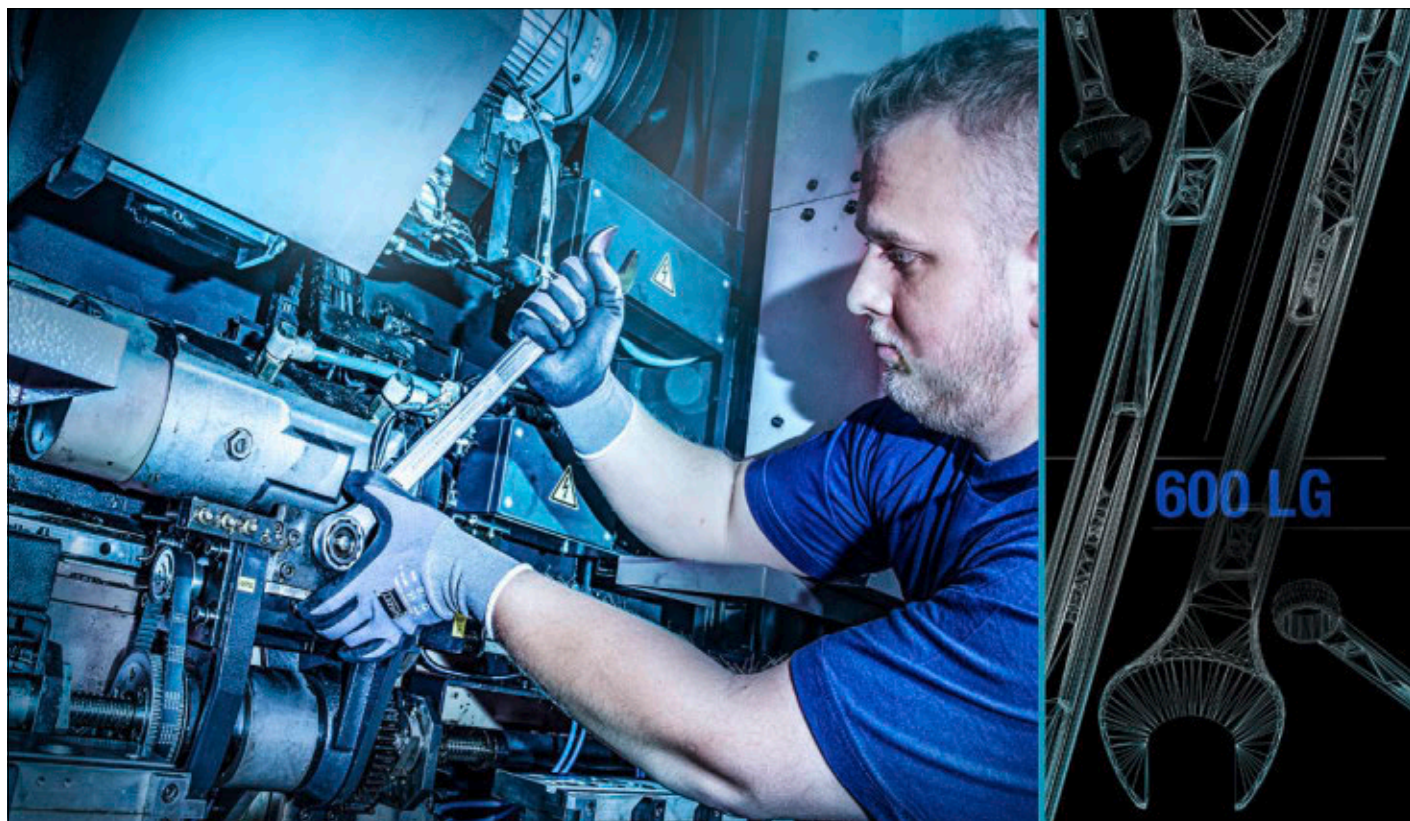



606 Sada ráčnových očkoplochých klíčů

• Povrch: chromováno



HAZET No.		EAN-No. 4000896+	€
606 • 6			
21 • 22 • 24 • 27 • 30 • 32			
606/6-1	6	175178	459,20

606 N Sada ráčnových očkoplochých klíčů

- SmartCase (1/3) 165-L
- Safety-Insert-System, 2komponentní vložka z měkké pěny. Vložka vhodná také pro HAZET-Assistent
- Povrch: chromováno



HAZET No.	$d \times \check{s} \times v$ mm		EAN-No. 4000896+	€
606 • 6				
8 • 9 • 10 • 11 • 12 • 13 • 14 • 15 • 16 • 17 • 18 • 19				
606 N/12	355x235x65	12	197378	284,90
606 • 6				
8 • 10 • 12 • 13 • 17 • 19				
606 N/6	355x235x65	6	196937	173,50

606 Sada ráčnových očkoplochých klíčů

- Safety-Insert-System, 2komponentní vložka z měkké pěny. Vložka vhodná také pro HAZET-Assistent

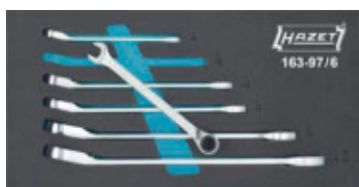

1/3			
-----	--	--	--

606 Sada ráčnových očkoplochých klíčů

HAZET No.	$d \times \check{s}$ mm		EAN-No. 4000896+	€
606 • 6				
8 • 10 • 12 • 13 • 17 • 19				
163-97/6	342x172	6	145683	138,80
Hodí se pro HAZET <i>Assistent</i> s hloubkou zásuvky 398 mm: 173 · 179 · 179 N · 179 W · 179 N W · 179 BIG-1 · 179 XL · 179 N XL · 179 XXL · 179 N XXL · 179 A XXL · 179 T XXL · 180				
606 • 6				
8 • 9 • 10 • 11 • 12 • 13 • 14 • 15 • 16 • 17 • 18 • 19 • 606/4 SPC				
163-515/16	392x172	16	218721	303,20
606 • 6				
8 • 9 • 10 • 11 • 12 • 13 • 14 • 15 • 16 • 17 • 18 • 19 • 21 • 22 • 24 • 27 • 30 • 32				
163-366/18	519x342	18	196920	607,-

610 N Oboustranné očkové klíče

Made in Germany

- Ergonomicky tvarovaný, přesazené hlavy
- Dřík s extra stabilním dvojitém T-profilem HAZET
- Povrch: chromováno, leštěná hlava
- DIN 837 tvar B, ISO 10103

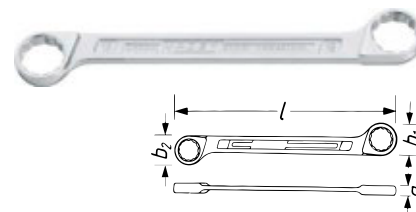

* = Mimo řady DIN

HAZET No.	l mm	a mm	b_1 mm	b_2 mm	EAN-No. 4000896+	€
610 N- 6x7	97,9	4,5	9,6	11	024940	10,85
610 N- 8x9	113,3	5,2	12,3	13,6	024957	11,-
610 N-10x11	125,3	6	14,9	16,2	024735	11,85
610 N-12x13	139	6,2	17,8	18,9	024742	12,25
610 N-14x15	154,5	7	20,2	21,5	024780	14,15
610 N-16x17	170	7,5	22,7	24,1	024797	16,25
610 N-18x19	188,6	8,5	26	27	024827	18,55
610 N-20x22 *	208,8	9	28,4	30,4	024834	21,90
610 N-21x22 *	232,3	10	29,8	32,2	024841	23,65
610 N-21x23 *	232,3	10	29,8	32,7	024858	23,65
610 N-24x26 *	254	11	34,1	37	024872	26,15
610 N-25x28 *	280,1	11,5	35,5	39,8	024896	30,85
610 N-27x32	308,7	13	38,9	45,4	024902	34,05
610 N-30x32	324,1	13	42,7	45,4	024919	34,05
610 N-30x34	326,7	14	42,7	48	024926	38,50

Made in Germany

- Safety-Insert-System, 2komponentní vložka z měkké pěny. Vložka vhodná také pro HAZET-Assistent

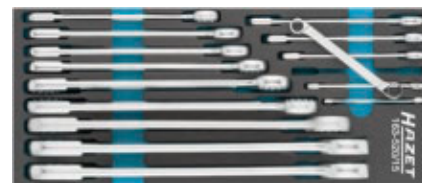

1/3			
-----	--	--	--

HAZET No.	$d \times \check{s}$ mm	l mm		EAN-No. 4000896+	€
Hodí se pro HAZET <i>Assistent</i> s hloubkou zásuvky 398 mm: 173 · 179 · 179 N · 179 W · 179 N W · 179 BIG-1 · 179 XL · 179 N XL · 179 XXL · 179 N XXL · 179 A XXL · 179 T XXL · 180					
610 N • 6					
6x7 • 8x9 • 10x11 • 12x13 • 14x15 • 16x17 • 18x19 • 20x22 21x22 • 21x23 • 24x26 • 25x28 • 27x32 • 30x32 • 30x34					
163-520/15	392x172	392	15	218677	307,30



Ruční nářadí

Klíče na šrouby



610 N Sada oboustranných očkových klíčů

Made in Germany

- Povrch: chromováno, leštěná hlava
- DIN 837 tvar B, ISO 10103



HAZET No.		EAN-No. 4000896+	€
610 N • ●			
6x7 • 8x9 • 10x11 • 12x13 • 14x15 • 16x17 • 18x19 • 21x22			
610 N/8	8	024995	117,90

Made in Germany

- Vhodné pro upevnění na stěnu
- Plastový svírací držák
- Povrch: chromováno, leštěná hlava
- DIN 837 tvar B, ISO 10103



HAZET No.	$d \times š \times v$ mm		EAN-No. 4000896+	€
610 N • ●				
6x7 • 8x9 • 10x11 • 12x13 • 14x15 • 16x17 • 18x19 • 21x22				
610 N/8 RS	260x110x55	8	025008	135,10
• S držadlem				
610 N • ●				
6x7 • 8x9 • 10x11 • 12x13 • 14x15 • 16x17 • 18x19 • 20x22 • 21x23 • 24x26 • 25x28 • 27x32				
610 N/12 RS	340x165x75	12	024988	267,30

630 Oboustranné očkové klíče

Made in Germany

- Hluboce zalomený
- Tenkostěnné hlavy
- Povrch: chromováno, leštěná hlava
- DIN 838, ISO 10104

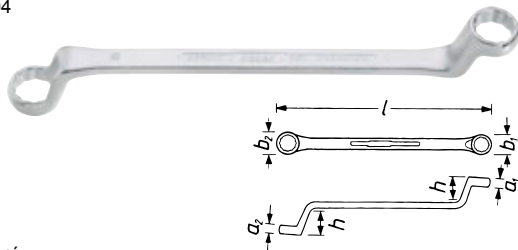

+ = Matně chromování
 * = Mimo řadu DIN

HAZET No.	l mm	h mm	a_1 mm	a_2 mm	b_1 mm	b_2 mm	EAN-No. 4000896+	€
630- 6x7	165	18	6	6,5	10,5	12,2	026555	11,-
630- 8x9	180	20,5	7	7,5	13,1	14,6	026579	11,60
630-10x11	200	23,5	8	9	15,6	17,1	026227	12,-
630-12x13	220	25	9	9,5	18,4	19,9	026241	14,45
630-14x15	240	27	10	10,5	21,4	22,5	026296	14,60
630-16x17	255	29	11	11,3	24	25,5	026302	16,25
630-17x19	265	29	11,3	11,9	25,5	28,4	026326	17,25
630-18x19	265	31	11,6	11,9	26,9	28,4	026333	17,55

630 Oboustranné očkové klíče

HAZET No.	l mm	h mm	a_1 mm	a_2 mm	b_1 mm	b_2 mm	EAN-No. 4000896+	€
630-20x22 *	295	32,5	12,2	12,9	29,3	32,2	026364	20,45
630-21x22	295	32,5	12,9	12,9	30,7	32,2	026371	22,50
630-21x23 *	315	34	12,5	13,2	30,7	33,6	026388	22,50
630-24x26 *	330	34	13,5	14,1	35,1	37,1	026401	26,75
630-24x27	340	35	13,5	14,4	35,1	38,5	026418	29,20
630-25x28 *	350	35	13,8	14,7	36,5	39,9	026432	29,20
630-27x32	365	36,5	14,4	16	38,5	45,5	026463	31,60
630-30x32	365	36,5	15,4	16	42,7	45,5	026470	32,95
630-36x41 +	440	40	17,2	18,8	51,3	58,2	026517	50,45

630 Sada oboustranných očkových klíčů

Made in Germany

- Safety-Insert-System, 2komponentní vložka z měkké pěny.
- Vložka vhodná také pro HAZET-Assistent

1/3 +				
-------	--	--	--	--



HAZET No.	$d \times š$ mm	l mm		EAN-No. 4000896+	€
Hodí se pro HAZET Assistent [®] s hloubkou zásuvky 398 mm: 173 · 179 · 179 N · 179 W · 179 N W · 179 BIG-1 · 179 XL · 179 N XL · 179 XXL · 179 N XXL · 179 A XXL · 179 T XXL · 180					
630 • ●					
6x7 • 8x9 • 10x11 • 12x13 • 14x15 • 16x17 • 18x19 • 20x22 • 21x23					
163-518/9	392x172	392	9	218707	142,90

Made in Germany

- Povrch: chromováno, leštěná hlava
- DIN 838, ISO 10104



HAZET No.		EAN-No. 4000896+	€
630 • ●			
6x7 • 8x9 • 10x11 • 12x13 • 14x15 • 16x17 • 18x19 • 21x22			
630/8	8	026654	119,-
630 • ●			
6x7 • 8x9 • 10x11 • 12x13 • 14x15 • 16x17 • 18x19 • 20x22 • 21x23 • 24x26 • 25x28 • 27x32			
630/12	12	026593	226,60



630 A Oboustranné očkové klíče

Made in Germany

- Hluboce zalomený
- Tenkostěnné hlavy
- Americké rozměry
- Povrch: chromováno, leštěná hlava
- ISO 1085

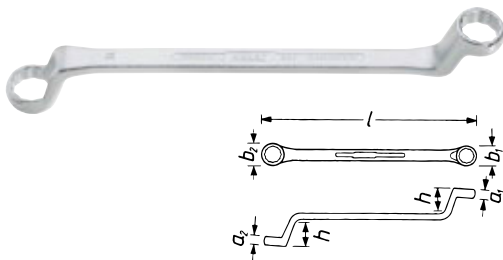

HAZET No.	l mm	h mm	a ₁ mm	a ₂ mm	b ₁ mm	b ₂ mm	EAN-No. 4000896+	€
630 A-1/4x5/16	170	19,5	6,6	7	12,2	13,1	026722	11,60
630 A-3/8x7/16	200	23,5	8	9	15,6	17,1	026807	12,40
630 A-1/2x9/16	230	26	9,5	10,5	19,9	22,5	026715	14,40
630 A-19/32x11/16	255	29	10,8	11,5	22,7	26,5	026753	16,90
630 A-5/8x3/4	265	29	11	11,9	24	28,4	026821	16,95
630 A-3/4x7/8	295	32,5	11,9	12,9	28,4	32,2	026791	21,75
630 A-29/32x13/16	295	32,5	12,2	12,5	29,3	30,2	026777	21,75
630 A-19/16x1	330	34	13,5	14,1	35,1	37,1	026746	26,90
630 A-1x1.1/8	350	36,5	14,1	15,6	36,3	42,1	026760	29,10
630 A-1.1/8x1.1/4	365	36,5	14,8	16,4	39,4	46,5	026692	34,70

612 Oboustranný očkový maticový klíč · otevřený

Made in Germany

- Pro trubková šroubení, převlečné matice a šrouby
 - Hlavy zahnuté v úhlu 15°
 - Rozevření 15° drážkované
 - Dřík s extra stabilním dvojitým T-profilem HAZET
- Upozornění: Pro práce na brzdovém vedení viz HAZET 612 N
- Povrch: chromováno
 - DIN 3118

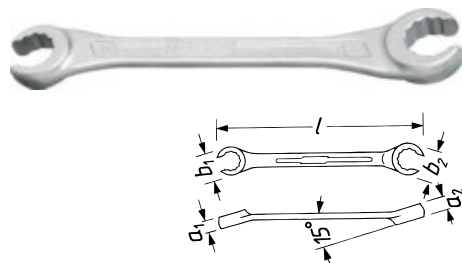

+ = 612-8x10 až 12x14 s 6hranem
* = 612-13x15 a 16x18 mimo řadu DIN

HAZET No.	l mm	a ₁ mm	a ₂ mm	b ₁ mm	b ₂ mm	EAN-No. 4000896+	€
612- 8x10 +	140	7	8	18	20	025206	19,40
612-10x11 +	147	8	8,7	20	22	025091	19,40
612-11x13 +	160	8,7	9,8	22	26	025107	21,20
612-12x14 +	168	9,2	10,3	24	28	025114	21,20
612-13x15 *	182	9,8	10,9	26	29	025121	21,20
612-16x18 *	208	12	13,2	30	32	025145	26,80
612-17x19	208	12	13,2	30	32	025152	27,10
612-19x22	222	13,8	15,8	34,5	40,5	025169	31,80
612-24x27	260	16,2	18	42	46	025183	46,-
612-30x32	300	21	23	50	52	025190	59,35



612 N Oboustranný očkový maticový klíč · otevřený

Made in Germany

- Pro šroubené spoje na vedeních
- zesílené provedení
- Zakřivený (15° a 40°)
- S šestihranem
- Rovná drážka
- Povrch: chromováno

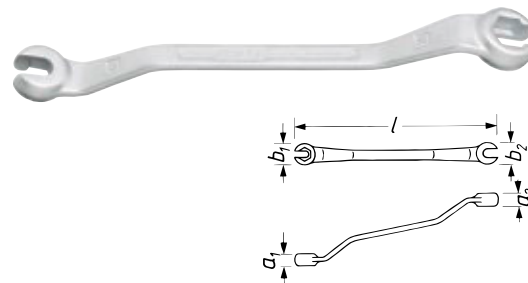

HAZET No.	l mm	a ₁ mm	a ₂ mm	b ₁ mm	b ₂ mm	EAN-No. 4000896+	€
612 N-10x11	172	11	11	20	21,5	025428	24,70
612 N-11x13	185,5	11,5	11,5	21,5	24,5	025435	24,70
612 N-12x14	198,5	11,5	11,5	23,2	26	025442	24,70

612 N Klíč na brzdové vedení · otevřený

Made in Germany

- zesílené provedení
- Rovný tvar pro manipulaci se šroubením na brzdovém potrubí a brzdové hadici na přední nápravě
- Zahnutý tvar umožňuje bezpečnou manipulaci se šroubením na brzdovém potrubí na válci kolové brzdy kolem oběžné hrany kotevní desky
- Neklouže
- Rovný zářez / se šestihranem
- Povrch: chromováno

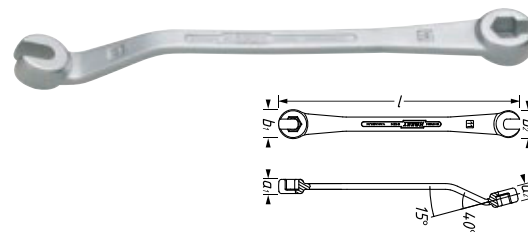

HAZET No.	l mm	a ₁ mm	a ₂ mm	b ₁ mm	b ₂ mm	EAN-No. 4000896+	€
612 N-11	177,7	11	11	20	21,5	129133	24,70

609 Oboustranné očkové klíče TORX®

Made in Germany

- Přímé provedení
- Povrch: chromováno, leštěná hlava

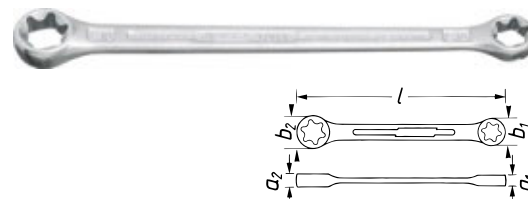

HAZET No.	l mm	a ₁ mm	a ₂ mm	b ₁ mm	b ₂ mm	mm	EAN-No. 4000896+	€
609-E 6xE 8	113	4,8	5,8	10	12	5,74x7,52	024711	12,35
609-E 10xE 12	140	6,8	8	13	15	9,42x11,17	024650	15,75
609-E 14xE 18	180	7,9	9,5	17	21	12,90x16,70	024674	20,90
609-E 20xE 24	224	11	13	24	28	18,49x22,16	024698	26,75



Program nástrčných klíčů



6.3 1/4"	Sady nástrčných hlavic	128–129
	Poháněcí nářadí	130–131
	Nástrčné hlavice	131–133
	Spojovací díly	133–134
10 3/8"	Sady nástrčných hlavic	134–136
	Poháněcí nářadí	136–138
	Nástrčné hlavice	138–141
	Nástrčné hlavice	142–143
	Spojovací díly	143–144
	Program pro rázové utahováky	144
12.5 1/2"	Sady nástrčných hlavic	145–146
	Poháněcí nářadí	147–149
	Nástrčné hlavice	149–151
	Nástrčné hlavice	151–155
	Spojovací díly	156–157
	Sady nástrčných hlavic pro rázový a strojový utahovák	157
	Nástrčné hlavice pro rázový a strojový utahovák	157–161
	Nástrčné hlavice pro rázový a strojový utahovák	161–162
	Spojovací díly pro rázový a strojní utahovák	163
20 3/4"	Sady nástrčných hlavic	164
	Poháněcí nářadí	165
	Nástrčné hlavice	165–166
	Spojovací díly	167
	Program pro rázové utahováky	167–168
25 1"	Sady nástrčných hlavic	169
	Poháněcí nářadí	169–170
	Nástrčné hlavice	170
	Spojovací díly	170
	Program pro rázové utahováky	170–171
	Nářadí TORX	172–173



HITPer

H I G H P E R F O R M A N C E

THE ORIGINAL

MADE IN GERMANY

Staticky A Dynamicky –
Dvojnásob precizní a perfektní!



1000 Nm
/ max. 614 mm

12⁵ 1/2

- Plynule výsuvná ze 414 na 614 mm (bez předfixovaných aretačních bodů)
- Snadná fixace prostřednictvím neklouzající upínací matice
- Rukojeť zajištěná proti přetočení zaručuje optimální přenos síly bez klouzání



reddot winner 2020



1000 Nm
/ 415 mm

12⁵ 1/2

Porovnání výkonu

Špičkové zatížení

DIN 3122:2017-04 (statické zatížení):
12⁵ 1/2 916 HPLg** · 916 HPL · 916 HP · 10 3/8 8816 HP · 6.3 1/4 863 HP B
Podle DIN 3122:2017-04 863 HP B

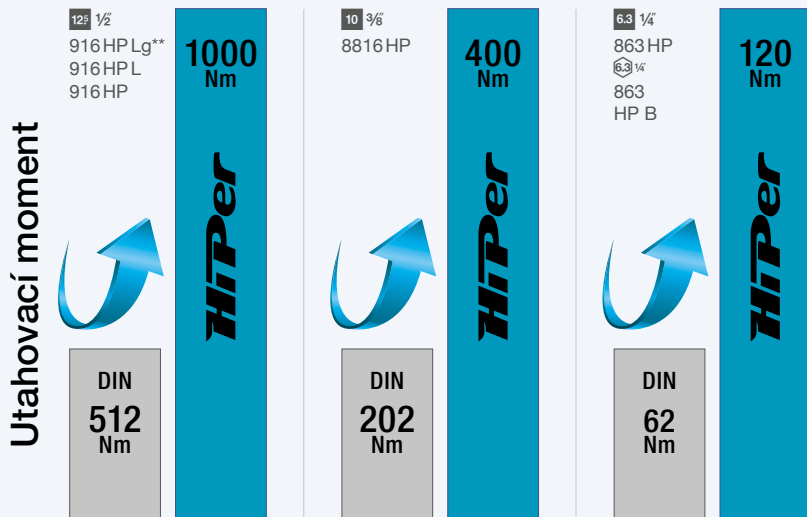

Dlouhá životnost · trvalá zátěž

ISO 3315:2018-05 (dynamické zatížení)
12⁵ 1/2 916 HPLg** · 916 HPL · 916 HP · 10 3/8 8816 HP · 6.3 1/4 863 HP
Podle ISO 3315:2018-05 863 HP B

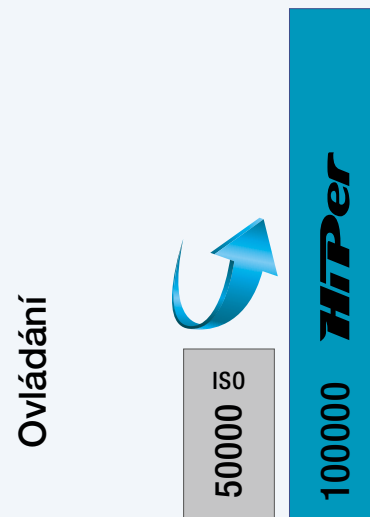

** Zjištěné v zasunutém stavu



Ruční nářadí

Program nástrčných klíčů



Jemnozubé přepínací ráčny

- Vyvinuto a vyrobeno „Made in Germany“
- Špičkové zatížení:
- $12\frac{5}{8}$ 1000 Nm $10\frac{3}{8}$ 400 Nm $6.3\frac{1}{4}$ 120 Nm
- Vysoká trvalá zátěž pro dlouhou životnost
- 90 zubů, 4° úhel ovládání pro úzké konstrukční prostory
- Aretační funkce páčky nabízí ochranu proti nechtěnému přepnutí
- Extrémně větší výkon při stejných konstrukčních rozměrech
- Úzké výrobní tolerance zaručují ochranu před vnikající nečistotou



1000 Nm
/ 275 mm
 $12\frac{5}{8}$



400 Nm
/ 200 mm
 $10\frac{3}{8}$



120 Nm
/ 116 mm
 $6.3\frac{1}{4}$



120 Nm
/ 116 mm
 $6.3\frac{1}{4}$



Proces výroby nástrčných hlavic HAZET – Nástrčná hlavice pro tvrdé použití

Dobrá práce od společnosti HAZET

Nástrčná hlavice

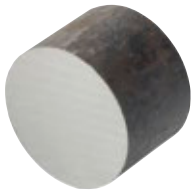

①

Část materiálu řezána z kruhové oceli



②

Polotovar broušený z vnější strany na požadovaný rozměr



③

Metalurgicky tepelně zpracovaný polotovar



④

Pískovaný polotovar



⑤

Hotový vnitřní profil, protlačovaný za studena, upravený vnější profil



⑥

Mechanicky zpracováno, soustruženo, vrtáno, vnitřní drážka frézována, rýhována a označena



⑦

Zušlechtěno = kalení a popouštění



⑧

Opracovaný, pískovaný povrch



⑨

Částečně broušená vnější plocha



⑩

Niklováno a chromováno

Nástrčná hlavice

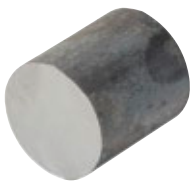

①

Část materiálu řezána z kruhové oceli



②

Polotovar broušený z vnější strany na požadovaný rozměr



③

Metalurgicky tepelně zpracovaný polotovar

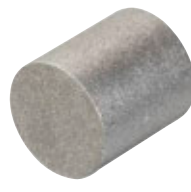

④

Pískovaný polotovar



⑤

Hotový vnitřní profil, protlačovaný za studena, upravený vnější profil



⑥

Mechanicky zpracováno, soustruženo, vrtáno, vnitřní drážka frézována, rýhována a označena



⑦

Zušlechtěno = kalení a popouštění



⑧

Opracovaný, pískovaný povrch



⑨

Niklováno a chromováno



⑩

Zalísovaná čepel

Výhody lisování za studena

- Vysoká rozměrová přesnost
- Vysoká jakost povrchu



Výrobní postup přepínací ráčny HAZET



①
Předstřížek

②
Kování

③
Odstrizení
otřepu

④
Soustružení

⑤
Obrábění
Zušlechťování

⑥
Chromování



⑦
Montáž
kolečka ráčny

⑧
Montáž
desky víka

⑨
Montáž
Pojistný kroužek

⑩
Montáž
rukojeti



Legenda:

- ① Fixační prvek
- ② Pružinové pouzdro
- ③ Přepínací páčka
- ④ Kulička
- ⑤ Tlačná pružina
- ⑥ Kolo ráčny
- ⑦ Krycí disk
- ⑧ Pojistný kroužek



Přehled

Pestrá nabídka přepínacích ráčen HAZET

		6.3 1/4"	10 3/8"	12.5 1/2"	20 3/4"	25 1"	6.3 1/4"	8 5/16"
	Jemné ozubení	863 HP 90 zubů l 116 mm	8816 HP 90 zubů l 200 mm	916 HP 90 zubů l 275 mm			863 HP B 90 zubů l 116 mm	
	Standardní	863 P 20 zubů l 115 mm	8816 P 30 zubů l 199 mm	916 SP 32 zubů l 275 mm	1016/2 32 zubů l 620 mm	1116/2 32 zubů l 824 mm		2264-1 30 zubů l 200 mm
	S kloubem		8816 G 30 zubů l 276 mm	916 GL 32 zubů l 511 mm				
	Krátké, s kloubem		8816 GK 30 zubů l 218 mm	916 GK 32 zubů l 270 mm				
	Krátké			916 K 32 zubů l 199 mm				
	Celokovové						863 M Bit 20 zubů l 89 mm	
	Dlouhé, jemně ozubené			916 HP L 90 zubů l 415 mm				
	Dlouhé, výsuvné, jemně ozubené			916 HP Lg 90 zubů l 414-614 mm				



Nástrčné hlavice HAZET

Provedení			6.3 1/4"	10 3/8"	12.5 1/2"	20 3/4"	25 1"
Hlavice pro nástrčné klíče pro ruční manipulaci							
	Šestihranný profil		850 (A) 3 – 14 (5/16 – 9/16)	880 6 – 22	900 8 – 36	1000 19 – 60	
	Dvojitý šestihranný profil			880 Z 9 – 22 (1/4 – 15/16)	900 Z 8 – 36 (3/8 – 1.1/4)	1000 Z 22 – 55 (7/8 – 2)	1100 Z 32 – 80
	Šestihranný profil, dlouhý		850 Lg 4 – 13	880 Lg 8 – 22	900 Lg 10 – 32		
	Dvojitý šestihranný profil, dlouhý		850 TZ 8	880 TZ 9 – 22	900 TZ 10 – 30		
	S kloubem, šestihranný profil			880 G 10 – 19			
	S kloubem, dvojitý šestihranný profil			880 G-Z 16 – 18			
	Vnější profil TORX		850-E E 4 – E 12	880 E E 5 – E 14	900 E E 10 – E 24		
	Vnější profil TORX , dlouhý			880 Lg-E E 8 – E 14			
	S kloubem, vnější profil TORX		850 Lg-G E 10	880 G E 8 – E 14			
Nástrčné hlavice pro ruční manipulaci							
	Plochý profil		8503 3,5 – 10		980 13 – 19		
	Plochý profil, dlouhý			8803 5,5 – 10			
	Křížový profil PH (Phillips)		8506 PH 1 – PH 4				
	Křížový profil PH (Phillips), dlouhý			8806 PH 1 – PH 4			
	Křížový profil PZ (Pozidriv)		8507 PZ 1 – PZ 3				
	Profil s vnitřním šestihranem		8501 2,5 – 8	8801 3 – 10	985 5 – 22 986 4 – 22 (5/32 – 1/2) 2584	1010 14 – 22 2784	
	Profil s vnitřním šestihranem, dlouhý			8801 3 – 12 (1/8 – 3/8)	986 (S) L 4 – 14 2584-1	2784 14	
	Profil s vnitřním šestihranem, dlouhý, kulová hlava		8501 KK 4	8801 KK 5 – 10	986 KK 5 – 12 2527-8		









Provedení			6.3 1/4"	10 3/8"	12.5 1/2"	20 3/4"	25 1"
Nástrčné hlavice pro ruční manipulaci							
	Vnitřní profil TORX [®]		8502 T 8 – T 40	8802 T 15 – T 50	992 T 20 – T 60	1012 T 60 – T 100	
	Vnitřní profil TORX [®] , dlouhý				992 (S) Lg T 30 – T 70		
	Profil Tamper TORX [®]				992 T 30 H – T 55 H		
	Profil RIBE CV				991 5 – 16		
	Profil vnitřního tisícíhranu (XZN)			8808 5 – 10	990 5 – 18		
	Profil vnitřního tisícíhranu (XZN), dlouhý			8808 Lg 6 – 10	990 Lg 6 – 14 2751		
Spojovací díly pro ruční manipulaci							
	Adaptér (rozšíření)	6.3 1/4"		8858-2			
	Adaptér (redukční a zvětšovací kus)	10 3/8"	858-1		958-2		
	Adaptér (redukční a zvětšovací kus)	12.5 1/2"		8858-1		1058-2	
	Adaptér (redukční a zvětšovací kus)	20 3/4"			958-1		1158-2
	Adaptér (redukce)	25 1"				1058-1	
	Adaptér pro bity		2250-1	2250-2 2250-3	2250-4 2250-5		
	Univerzální kloub		869	8820	920	1021	1121
Nástrčné hlavice pro strojní manipulaci							
	Šestihranný profil pro strojní manipulaci				900 S 13 – 32	1000 S 19 – 36	1100 S 24 – 60
	Šestihranný profil, dlouhý, pro strojní manipulaci				900 S Lg 13 – 27	1000 S Lg 24 – 36	1100 S Lg 24 – 46
	Šestihranný profil, dlouhý, velmi úzký pro strojní manipulaci				901 S Lg 902 S Lg 15 – 21		
	Šestihranný profil, velmi dlouhý, pro strojní manipulaci					1004 S 32	1104 S 32



Ruční nářadí

Program nástrčných klíčů



Provedení		6.3 1/4"	10 3/8"	12.5 1/2"	20 3/4"	25 1"
Nástrčné hlavice pro strojní manipulaci						
	Dvojitý šestihranný profil, pro strojní manipulaci				900 S 12 - 36 900 SZ 6-19-36 3047-36	
	Vnější profil TORX ®, pro strojní manipulaci			880 S-E 10 - 12	900 S-E10 - 24	
	Vnější profil TORX ®, dlouhý, pro strojní manipulaci				2850-E 20, 24	
Nástrčné hlavice pro strojní manipulaci						
	Profil s vnitřním šestihranem, pro strojní manipulaci				985 S 14 - 24	
	Profil s vnitřním šestihranem, dlouhý, pro strojní manipulaci				985 S Lg 14 - 19	
	Profil vnitřního tisícíhranu (XZN), pro strojní manipulaci				990 S 14 - 18	
	Profil vnitřního tisícíhranu (XZN), dlouhý, pro strojní manipulaci				990 S Lg 14 - 18	
	Vnitřní profil TORX ®, pro strojní manipulaci				995 S T 30 - T 60	
Spojovací díly pro strojní manipulaci						
	Kloubový díl, pro strojní manipulaci				9006 S	1006 S 1106 S
	Redukční díl, pro strojní manipulaci			8807 S	9007 S	1007 S-1 1107 S
	Zvětšovací díl, pro strojní manipulaci			8807 S-1	9007 S-1	1007 S-2
	Adaptér, pro strojní manipulaci		8508 S-1	8808 S-1		
	Adaptér, pro strojní manipulaci		2304 2238-1 8508 S-3 4			
	Adaptér, pro strojní manipulaci				2311	
	Adaptér, pro strojní manipulaci					1003 S-1



853 Sada nástrčných klíčů

- SmartCase (1/9) 165-S
- Safety-Insert-System, 2komponentní vložka z měkké pěny.
- Vložka vhodná také pro HAZET-Assistent



HiPer
HIGH PERFORMANCE
THE ORIGINAL
MADE IN GERMANY



1/9				
-----	--	--	--	--

360°

850 • • 1/4
5.5 • 6 • 7 • 8 • 9
10 • 11 • 12 • 13 • 14

863 HP • 1/4

866 U • 1/4

867-2 • 1/4 • 1/4

867-4 • 1/4 • 1/4

2204 • • 1/4
3 • 4 • 5 • 6 • 7

2208 • • 1/4
0.6x4.5 • 1.2x6.5 • 1.2x8

2215 • • 1/4
PH 1 • PH 2 • PH 3

2216 • • 1/4
PZ 1 • PZ 2 • PZ 3

2223 • • 1/4
T 10 H • T 15 H • T 20 H
T 25 H • T 27 H • T 30 H
T 40 H

2250-1 • • 1/4

HAZET No.	d x š x v mm		EAN-No. 4000896+	€
853-1	185x153x52	36	154654	193,60

854 Sada nástrčných klíčů

Made in Germany



- Nástrčné nástavce šroubováku s vrstvou CVD-TIN
- SmartCase (1/9) 165-S
- Safety-Insert-System, 2komponentní vložka z měkké pěny.
- Vložka vhodná také pro HAZET-Assistent



HiPer
HIGH PERFORMANCE
THE ORIGINAL
MADE IN GERMANY



1/9				
-----	--	--	--	--

850 • • 1/4
4 • 5 • 6 • 7 • 8 • 9
10 • 11 • 12 • 13 • 14

8501 • • 1/4
3 • 4 • 5 • 6 • 8

8503 • • 1/4
0.6x3.5 • 0.8x4
1x5.5 • 1.2x8

8506 • • 1/4
PH 1 • PH 2 • PH 3 • PH 4

8507 • • 1/4
PZ 1 • PZ 2 • PZ 3

863 HP • 1/4

865 • 1/4

866 U • 1/4

867-2 • 1/4 • 1/4

868 • 1/4 • 1/4

869 • 1/4 • 1/4

HAZET No.	d x š x v mm		EAN-No. 4000896+	€
854-1	185x153x52	33	038343	270,-

854 Sada nástrčných klíčů

Made in Germany



- Nástrčné nástavce šroubováku s vrstvou CVD-TIN
- SmartCase (1/9) 165-S
- Safety-Insert-System, 2komponentní vložka z měkké pěny.
- Vložka vhodná také pro HAZET-Assistent



HiPer
HIGH PERFORMANCE
THE ORIGINAL
MADE IN GERMANY



1/9				
-----	--	--	--	--

850 • • 1/4
4 • 5 • 5.5 • 6
7 • 8 • 9 • 10
11 • 12 • 13 • 14

8501 • • 1/4
3 • 4 • 5 • 6 • 8

8503 • • 1/4
0.6x3.5 • 1x5.5 • 1.2x8

8506 • • 1/4
PH 1 • PH 2

8507 • • 1/4
PZ 1 • PZ 2

863 HP • 1/4

865 • 1/4

866 U • 1/4

867-2 • 1/4 • 1/4

868 • 1/4 • 1/4

869 • 1/4 • 1/4

HAZET No.	d x š x v mm		EAN-No. 4000896+	€
854	185x153x52	30	038336	245,50

854 T Sada nástrčných klíčů

Made in Germany



- Nástrčné nástavce šroubováku s vrstvou CVD-TIN
- SmartCase (1/9) 165-S
- Safety-Insert-System, 2komponentní vložka z měkké pěny.
- Vložka vhodná také pro HAZET-Assistent



HiPer
HIGH PERFORMANCE
THE ORIGINAL
MADE IN GERMANY



1/9				
-----	--	--	--	--

850 • • 1/4
5 • 5.5 • 6 • 7
8 • 9 • 10 • 11
12 • 13 • 14

850 E • • 1/4
E 5 • E 6 • E 7 • E 8 • E 10

8501 • • 1/4
3 • 4 • 5 • 6

8502 • • 1/4
T 10 • T 15 • T 20
T 25 • T 30

8503 • • 1/4
1x5.5

8506 • • 1/4
PH 2

863 HP • 1/4

866 U • 1/4

867-2 • 1/4 • 1/4

868 • 1/4 • 1/4

869 • 1/4 • 1/4

871-4 • 1/4 • 1/4

HAZET No.	d x š x v mm		EAN-No. 4000896+	€
854 T	185x153x52	33	109579	296,30



Ruční nářadí

6.3 1/4" Program nástrčných klíčů



855 Sada nástrčných klíčů

Made in Germany

- Nástrčné hlavice v dlouhém a krátkém provedení
- Nástrčné nástavce šroubováku s vrstvou CVD-TIN
- SmartCase (1/3) 165-L
- Safety-Insert-System, 2komponentní vložka z měkké pěny. Vložka vhodná také pro HAZET-Assistent



1/3			
-----	--	--	--

- 850 • 6.3 1/4
4 • 4.5 • 5 • 6
7 • 8 • 9 • 10
11 • 12 • 13

- 850 LG • 6.3 1/4
5 • 6 • 7 • 8 • 9
10 • 11 • 12 • 13

- 850 E • 6.3 1/4
E 5 • E 6 • E 7 • E 8 • E 10

- 8501 • 6.3 1/4
3 • 4 • 5

- 8502 • 6.3 1/4
T 10 • T 15 • T 20
T 25 • T 30

- 8503 • 6.3 1/4
1x5.5

- 8506 • 6.3 1/4
PH 2

- 863 HP • 6.3 1/4

- 866 U • 6.3 1/4

- 867-2 • 6.3 1/4 • 6.3 1/4

- 867-4 • 6.3 1/4 • 6.3 1/4

- 869 • 6.3 1/4 • 6.3 1/4

HAZET No.	d x š x v mm		EAN-No. 4000896+	€
855-1	355x235x65	40	115983	363,80

2200 Sada nástrčných klíčů

- SmartCase (1/9) 165-S
- Safety-Insert-System, 2komponentní vložka z měkké pěny. Vložka vhodná také pro HAZET-Assistent



1/9			
-----	--	--	--

- 850 • 6.3 1/4
5 • 5.5 • 6 • 7
8 • 9 • 10 • 11
12 • 13 • 14

- 2204 • 6.3 1/4
2 • 2.5 • 3 • 4 • 5 • 6 • 8

- 2208 • 6.3 1/4
0.5x4 • 0.6x4.5
1.2x6.5 • 0.8x5.5

- 2215 • 6.3 1/4
PH 1 • PH 2

- 2216 • 6.3 1/4
PZ 1 • PZ 2

- 2223 • 6.3 1/4
T 10 H • T 15 H • T 20 H
T 25 H • T 30 H • T 40 H

- 2238-1 • 6.3 1/4 • 6.3 1/4

- 2239-3 • 6.3 1/4 • 6.3 1/4

- 863 HP B • 6.3 1/4

- 2304 • 6.3 1/4 • 6.3 1/4

HAZET No.	d x š x v mm		EAN-No. 4000896+	€
2200/36	185x153x52	36	063734	194,20

856 Sada nástrčných klíčů

- Ergonomický design
- Komfortní manipulace s nářadím, které je vždy po ruce
- SmartCase (52 x 98 x 180 mm)



- 850 • 6.3 1/4
5.5 • 6 • 7 • 8 • 9
10 • 11 • 12 • 13 • 14

- 863 P • 6.3 1/4

- 866 U • 6.3 1/4

- 867-2 • 6.3 1/4 • 6.3 1/4

- 867-4 • 6.3 1/4 • 6.3 1/4

- 869 • 6.3 1/4 • 6.3 1/4

- 2204 • 6.3 1/4
3 • 4 • 5 • 6 • 7

- 2208 • 6.3 1/4
0.6x4.5 • 1.2x6.5 • 1.2x8

- 2215 • 6.3 1/4
PH 1 • PH 2 • PH 3

- 2216 • 6.3 1/4
PZ 1 • PZ 2 • PZ 3

- 2223 • 6.3 1/4
T 10 H • T 15 H • T 20 H
T 25 H • T 27 H • T 30 H
T 40 H

- 2250-1 • 6.3 1/4 • 6.3 1/4

- 2304 • 6.3 1/4 • 6.3 1/4

HAZET No.	d x š x v mm		EAN-No. 4000896+	€
856-1	180x98x52	38	164813	184,20

863-Bit Sada bitů

- S přepínací ráčnou z oceli 863 MBIT



YouTube Clip

- 863 M Bit • 6.3 1/4

- 2204 • 6.3 1/4
3 • 4 • 5 • 6

- 2208 • 6.3 1/4
0.6x4.5 • 0.8x5.5 • 1x6

- 2215 • 6.3 1/4
PH 1 • PH 2 • PH 3

- 2216 • 6.3 1/4
PZ 1 • PZ 2 • PZ 3

- 2223 • 6.3 1/4
T 10 • T 15 • T 20 • T 25
T 27 • T 30 • T 40

- 2223 • 6.3 1/4
T 10 H • T 15 H • T 20 H
T 25 H • T 27 H • T 30 H
T 40 H

- 2239-6 • 6.3 1/4 • 6.3 1/4

HAZET No.	d x š x v mm		EAN-No. 4000896+	€
863 M Bit/33	125x87x38	33	196951	98,35



850 HL Svorkovnice

- Jednoduchá montáž: 2 otvory, např. pro upevnění na zeď
- Velikost svorek přizpůsobená velikosti pohonu
- Prázdné, s 16 přídržnými svorkami
- Uchytení nástrčných hlavice řady 850

6.3 1/4"



HAZET No.	l / mm	EAN-No. 4000896+	€
850 HL	430	037575	9,30

863 Přepínací ráčna · jemně ozubená

Made in Germany

- Extrémně větší výkon než u ráčen se srovnatelnými rozměry

6.3 1/4"

- Aretační funkce přepínací páčky nabízí ochranu proti nechtěnému přepnutí
- Prodloužení životnosti použitím nejmodernějších maziv v ráčnovém mechanismu
- Úzké výrobní tolerance zaručují ochranu před vnikající nečistotou
- Interní standardy kvality HAZET zaručují zatížitelnost dalece nad normu
- Chromovaný povrch: Hodnotný, snadné čištění, odolný vůči korozi
- V rukojeti integrovaný prvek pro zavěšení
- VPA ověřený, statický utahovací moment dle DIN 3122: 120 Nm (DIN: 62 Nm)
- Počet zubů: 90
- Úhel ovládání: 4°
- S kuličkovou pojistkou
- 2komponentní rukojeť HAZET
- Povrch: chromováno
- DIN 3122, ISO 3315



YouTube Clip



HiPer
HIGH PERFORMANCE
THE ORIGINAL
MADE IN GERMANY



HAZET No.	l / mm	EAN-No. 4000896+	€
863 HP	116	226917	50,-

863 Přepínací ráčna

Made in Germany

- Počet zubů: 20
- Úhel ovládání: 18°
- S kuličkovou pojistkou
- 2komponentní rukojeť HAZET
- Povrch: chromováno, leštěná hlava
- DIN 3122, ISO 3315

6.3 1/4"



360°



863 Přepínací ráčna

6.3 1/4"

HAZET No.	l / mm	EAN-No. 4000896+	€
863 P	115	038558	45,-

863-Bit Přepínací ráčna · celokovová · na bity

Made in Germany

- 89 mm, krátké provedení

6.3 1/4"

- Robustní provedení, krátký štíhlý tvar
- Ergonomická opěra prstu na konci rukojeti
- Počet zubů: 20
- Úhel ovládání: 18°
- Zahnutí v úhlu 15° – proti nebezpečí skřípnutí
- S pružinovou pojistkou pro bezpečné držení bitů
- Povrch: chromováno



YouTube Clip



HAZET No.	l / mm	EAN-No. 4000896+	€
863 M Bit	89	196111	46,80

863-Bit Přepínací ráčna pro bity · jemně ozubená

Made in Germany

- Extrémně větší výkon než u ráčen se srovnatelnými rozměry

6.3 1/4"

- Aretační funkce přepínací páčky nabízí ochranu proti nechtěnému přepnutí
- Prodloužení životnosti použitím nejmodernějších maziv v ráčnovém mechanismu
- Úzké výrobní tolerance zaručují ochranu před vnikající nečistotou
- Interní standardy kvality HAZET zaručují zatížitelnost dalece nad normu
- Chromovaný povrch: Hodnotný, snadné čištění, odolný vůči korozi
- V rukojeti integrovaný prvek pro zavěšení
- VPA ověřený, statický utahovací moment podle DIN 3122: 120 Nm (DIN: 62 Nm)
- Počet zubů: 90
- Úhel ovládání: 4°
- S pružinovou pojistkou pro bezpečné držení bitů
- 2komponentní rukojeť HAZET
- Povrch: chromováno



HiPer
HIGH PERFORMANCE
THE ORIGINAL
MADE IN GERMANY



HAZET No.	l / mm	EAN-No. 4000896+	€
863 HP B	116	235346	50,-



Ruční nářadí

6.3 1/4" Program nástrčných klíčů



Opotřeбенí? – Žádný problém!

- Nářadí HAZET je vyrobeno v nejvyšší kvalitě. Při dlouhém, intenzivním namáhání dochází i u vysoce kvalitních nástrojů k určitému opotřeбенí.
- Proto nabízíme pro mnoho našich nástrojů náhradní díly a sady náhradních dílů.

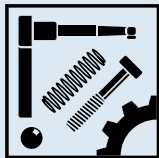

Nezapomeňte na náš obchod s náhradními díly
www.hazet.de/ersatzteil-shop

Úspora nákladů – udržitelnost – šetří zdroje!
Abyste se mohli ze svého nářadí HAZET dlouho těšit

863 Sada náhradních dílů

Made in Germany

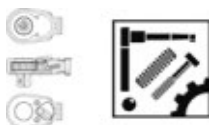

HAZET No.	l mm	EAN-No. 4000896+	€
Sada náhradních dílů 6,3 = 1/4" ■, obsah sady: fixační prvek, přítlačná pružina, kulička, pružinové pouzdro, přepínací páka, krycí kotouč, pojistný kroužek, ráčnové kolo, tuk, montážní nářadí Pro přepínací ráčnu 863 HP			
863 HP/11		234875	27,50
Sada náhradních dílů ovládací páky obsah sady: ovládací páka · fixační prvek · šrouby · kulička · tlačná pružina Pro přepínací ráčny HAZET 863 K · 863 · 863 G · 863 P · 863 PC · 863 Q · 863 S · 863 ST · 863 BGL · 863 BKC · 863 BK · 863 MC · 863 Mbit · 2264			
863 P/6		144600	7,40
Sada náhradních dílů kolečka ráčny 6,3 = 1/4" ■, obsah sady: kolečko ráčny · fixační prvek · ovládací páka · šrouby · kulička · tlačná pružina Pro přepínací ráčnu HAZET 863 G · 863 P · 863 PC · 863 ST · 863 K · 863 MC			
863 P/7 N		038596	17,45
Sada náhradních dílů kolečka ráčny 6,3 = 1/4" ■, obsah sady: kolečko ráčny se spouštěcím tlačítkem · fixační prvek · ovládací páka · šrouby · kulička · tlačná pružina Pro přepínací ráčny HAZET 863 Q · 863 S a k přestavení přepínací ráčny HAZET 863 P · 863 PC · 863 G · 863 ST · 863 K · 863 MC			
863 S/7		048472	24,15
Sada náhradních dílů kolečka ráčny ○ 6,3 = 1/4" obsah sady: kolečko ráčny · fixační prvek · ovládací páka · šrouby · kulička · tlačná pružina Pro přepínací ráčnu HAZET 863 BGL · 863 BKC · 863 BK · 863 Mbit · 2264			
2264/7		015917	24,75

866 U Zástrčná rukojeť

Made in Germany

- S kuličkovou pojistkou
- 2komponentní rukojeť HAZET
- Povrch: matně chromováno
- DIN 3122, ISO 3315



HAZET No.	l mm	EAN-No. 4000896+	€
866 U	134	056453	18,30

865 Příčná rukojeť

Made in Germany

- S kuličkovou pojistkou
- Povrch: chromováno, leštěno
- DIN 3122, ISO 3315



HAZET No.	l mm	EAN-No. 4000896+	€
865	115	038718	11,45

850 Nástrčná hlavice · šestihran

Made in Germany

- S rýhováním
- Povrch: chromováno, leštěno
- DIN 3124, ISO 2725-1

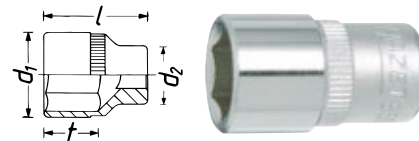

850-3 mimo řady DIN

HAZET No.	l mm	d ₁ mm	d ₂ mm	t mm	EAN-No. 4000896+	€
850- 3	25	6,2	11	3,2	057221	7,25
850- 4	25	6,8	11	3,7	036370	6,50
850- 4.5	25	7,4	11	4,2	036387	6,50
850- 5	25	8,1	11	4,1	036400	6,50
850- 5.5	25	8,7	11	4,6	036417	6,50
850- 6	25	9,3	11	5,1	036479	6,50
850- 7	25	10,9	11,5	5,5	036516	6,50
850- 8	25	12,1	12,5	6,5	036547	5,90
850- 9	25	13,4	12,5	7,5	036585	6,50
850-10	25	14,6	12,5	7,3	036202	5,75
850-11	25	15,5	14	8,3	036240	6,50
850-12	25	17	15	9,3	036271	7,05
850-13	25	18	15	9,3	036301	6,05
850-14	25	19,5	16	10,8	036349	7,05

850 A Nástrčná hlavice · šestihran

Made in Germany

- Americké rozměry
- S rýhováním
- Povrch: chromováno, leštěno
- DIN 3124, ISO 2725-1

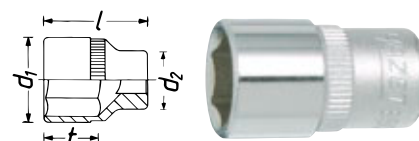

HAZET No.	l mm	d ₁ mm	d ₂ mm	t mm	EAN-No. 4000896+	€
850 A-3/16	25	8	11	4,2	037490	6,80
850 A-7/32	25	8,5	11	4,6	037537	6,80
850 A-1/4	25	9,5	11	5,1	037476	6,80
850 A-9/32	25	10,5	11,5	5,6	037551	6,80
850 A-5/16	25	11,5	12,5	6,3	037513	6,80
850 A-11/32	25	13	11,5	7,3	037483	6,80
850 A-3/8	25	14	12,5	7,3	037506	6,80
850 A-7/16	25	15,5	14	8,3	037520	6,80
850 A-1/2	25	18	15	9,3	037469	7,30
850 A-9/16	25	19,5	16	10,8	037544	7,30

850 LG Nástrčná hlavice · šestihran

Made in Germany

- Dlouhé provedení
- S rýhováním
- Povrch: chromováno
- DIN 3124



HAZET No.	l mm	d ₁ mm	d ₂ mm	t mm	EAN-No. 4000896+	€
850 Lg- 4	50	6,9	11	4	037643	17,-
850 Lg- 5	50	8,2	11	4,2	037650	17,-
850 Lg- 5.5	50	8,8	11	5	037667	17,50
850 Lg- 6	50	9,4	11	5,5	037674	17,50
850 Lg- 7	50	11	11	6	037681	17,50
850 Lg- 8	50	12	12	8	037698	17,50
850 Lg- 9	50	13	13	8	037704	17,50
850 Lg-10	50	14,5	14,5	9,2	037599	17,60
850 Lg-11	50	15,5	15,5	10,7	037605	17,60
850 Lg-12	50	17	17	12,2	037612	17,90
850 Lg-13	50	18	18	12,2	037629	17,90



850 TZ Nástrčná hlavice · dvojitý šestihran

Made in Germany

• Manipulace se šrouby na krytu rozvodového řetězu u např. VW 1,2l TSI motorů

- Dlouhé provedení
- S rýhováním
- Povrch: chromováno
- DIN 3124, ISO 2725-1

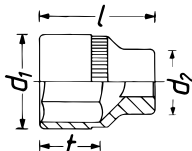

HAZET No.	l mm	d ₁ mm	d ₂ mm	f mm	EAN-No. 4000896+	€
850 TZ-8	50	12,2	12,2	8	177646	17,50

960 MGT Magnetická vložka pro nástrčné klíče

• Univerzálně použitelné v metrických nástrčných hlavících s 6hranem a dvojitým 6hranem s 10 až 19 mm

- Plastové vložky s integrovaným magnetem
- Vysoká přidržná síla
- Opakované použití
- **10dílná sada, pro metrické nástrčné klíče** s 10 · 11 · 12 · 13 · 14 · 15 · 16 · 17 · 18 · 19 mm
- DIN 3124, ISO 2725-1

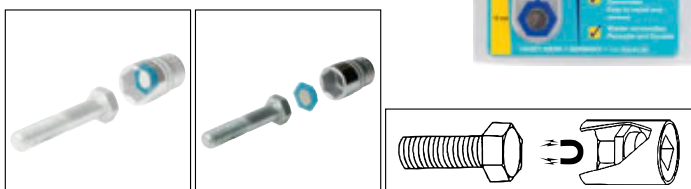

HAZET No.	EAN-No. 4000896+	€
960 MGT	097661	23,80

850 E Nástrčná hlavice TORX®

Made in Germany

- S rýhováním
- Povrch: chromováno, leštěno
- DIN 3124, ISO 2725-1

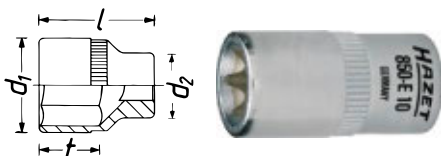

HAZET No.	l mm	d ₁ mm	d ₂ mm	mm	EAN-No. 4000896+	€
850-E 4	25	5,6	11	3,86	036653	7,60
850-E 5	25	6,7	11	4,75	036684	7,60
850-E 6	25	8	11	5,74	036714	7,60
850-E 7	25	9,6	11	6,22	036745	7,60
850-E 8	25	10,5	11,5	7,52	036776	7,60
850-E 10	25	13	12	9,42	036615	7,95
850-E 11	25	14	12,5	10,08	036646	7,95
850-E 12	25	14,9	12,5	11,17	188598	8,45

850 LG-GE Nástrčná hlavice TORX®

Made in Germany

- Nástrčná hlavice a prodloužení jsou pevně spojeny
- S kloubem – pro použití na těžko přístupných místech a pro obejít rušivých hran
- Povrch: chromováno, leštěno
- DIN 3124, ISO 2725-1

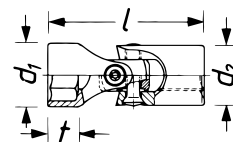
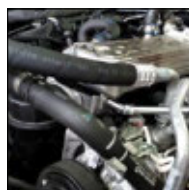

HAZET No.	l mm	d ₁ mm	d ₂ mm	mm	EAN-No. 4000896+	€
850 Lg-GE 10	150	12	13,5	9,42	223572	35,50

8501 Nástrčná hlavice

Made in Germany

- Povrch: TiN
- DIN 7422

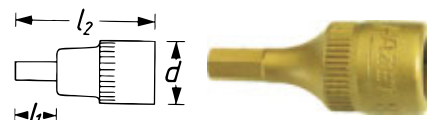

HAZET No.	S mm	l ₁ mm	l ₂ mm	d mm	EAN-No. 4000896+	€
8501-2.5	2,5	6,5	28	12	036837	7,60
8501-3	3	6,5	28	12	036851	7,60
8501-4	4	6,5	28	12	036875	7,60
8501-5	5	6,5	28	12	036899	7,60
8501-6	6	6,5	28	12	036912	7,60
8501-7	7	6,5	28	12	210398	7,60
8501-8	8	6,5	28	12	036936	7,60

Povrchová úprava TiN



Proč povrchová úprava TiN (nitrid titanu)?

- Speciální metoda velmi tvrdé povrchové úpravy TiN dosahuje extrémně vysoké přilnavosti a otěruvzdornosti vrstvy
- Optimálně vhodné při dlouhodobém zatížení, např. sériovém šroubování v průmyslu a dílnách
- Vyšší ochrana proti opotřebení zajišťuje delší životnost
- Perfektní přesnost díky optimální tloušťce vrstvy
- Vyšší utahovací moment
- Optimální ochrana proti korozi

Nástrčné hlavice s TiN úpravou

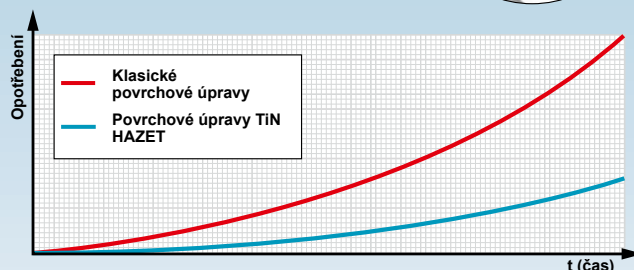
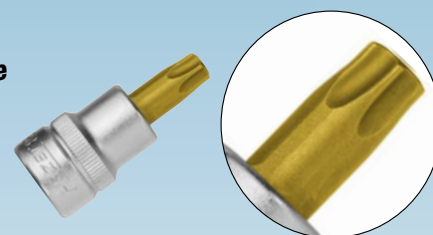



8501 KK Nástrčná hlavice

Made in Germany

- Dlouhé provedení
- S kulovou hlavou
- DIN 3124, ISO 2725-1

6.3 1/4"

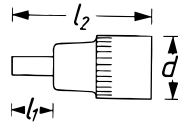

HAZET No.	S mm	l ₁ mm	l ₂ mm	d mm	EAN-No. 4000896+	€
8501 KK-4	4	60	80	12	157839	13,-

8502 Nástrčná hlavice TORX®

Made in Germany

- S rýhováním
- Povrch:
- DIN 3124, ISO 2725-1

TIN 6.3 1/4"

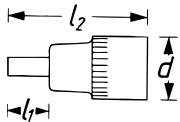
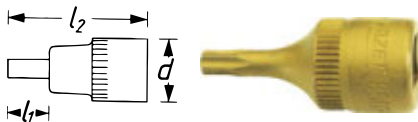

HAZET No.	l ₁ mm	l ₂ mm	d mm	mm	EAN-No. 4000896+	€
8502-T 8	3,5	28	12	2,31	037124	9,45
8502-T 9	3,5	28	12	2,50	037148	9,45
8502-T 10	3,8	28	12	2,74	036967	9,45
8502-T 15	4	28	12	3,27	036981	9,45
8502-T 20	4	28	12	3,86	037001	9,45
8502-T 25	4,5	28	12	4,43	037025	9,55
8502-T 27	4,5	28	12	4,99	037049	9,55
8502-T 30	5	28	12	5,52	037063	9,55
8502-T 40	2	28	12	6,65	037100	9,55

8503 Nástrčná hlavice

Made in Germany

- S rýhováním
- Povrch:
- Špička podle ISO 8764-1, DIN 3124, ISO 2725-1

TIN 6.3 1/4"

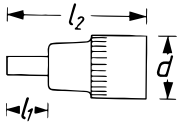
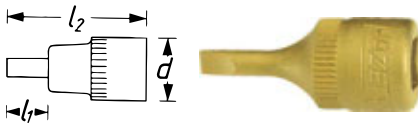

HAZET No.	l ₁ mm	l ₂ mm	d mm	EAN-No. 4000896+	€
8503-0.6x3.5	16	28	12	037162	7,60
8503-0.8x4	16	28	12	037186	7,60
8503-1x5.5	16	28	12	037247	7,60
8503-1.2x8	16	28	12	037209	7,60
8503-1.6x10	16	28	12	037223	7,60

8506 Nástrčná hlavice

Made in Germany

- S rýhováním
- Povrch:
- Špička podle ISO 8764-1, DIN 3124, ISO 2725-1

TIN 6.3 1/4"

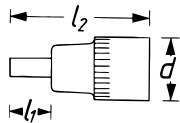
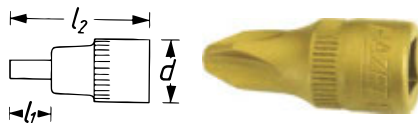

HAZET No.	l ₁ mm	l ₂ mm	d mm	EAN-No. 4000896+	€
8506-PH 1	16	28	12	037285	7,60
8506-PH 2	16	28	12	037308	7,60
8506-PH 3	16	28	12	037322	7,60
8506-PH 4	16	28	12	037346	7,60

8507 Nástrčná hlavice

Made in Germany

TIN 6.3 1/4"

- S rýhováním
- Povrch:
- Špička podle ISO 8764-1, DIN 3124, ISO 2725-1

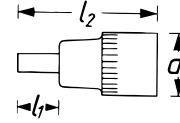
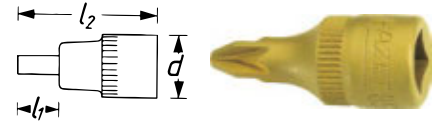

HAZET No.	l ₁ mm	l ₂ mm	d mm	EAN-No. 4000896+	€
8507-PZ 1	16	28	12	037360	8,50
8507-PZ 2	16	28	12	037377	8,50
8507-PZ 3	16	28	12	037384	8,50

858 Adaptér

Made in Germany

10 3/8" 6.3 1/4"

- S kuličkovou pojistkou
- Povrch: chromováno
- DIN 3123, ISO 3316



HAZET No.	l mm	EAN-No. 4000896+	€
858-1	26,5	038480	11,75

2250 Adaptér

Made in Germany

6.3 1/4" 6.3 1/4"

- Pro ruční manipulaci
- Uchytení vnitřní 4hran a vnitřní 6hran
- Přídružná kulička pro bity
- Povrch: chromováno



HAZET No.	l mm	EAN-No. 4000896+	€
2250-1	23,5	015443	12,-

869 Univerzální kloub

Made in Germany

6.3 1/4" 6.3 1/4"

- S kloubem – pro použití na těžko přístupných místech a pro obejítí rušivých hran
- S kuličkovou pojistkou
- Povrch: chromováno
- DIN 3123, ISO 3316



HAZET No.	l mm	EAN-No. 4000896+	€
869	36,5	038824	26,10

867 Prodloužení

Made in Germany

6.3 1/4" 6.3 1/4"

- S kuličkovou pojistkou
- Povrch: chromováno, leštěno
- DIN 3123, ISO 3316



HAZET No.	l mm	EAN-No. 4000896+	€
867-1	25	038732	10,20
867-2	55	038749	10,55
867-4	101,5	038770	11,75



868 Prodloužení

Made in Germany

- S kuličkovou pojistkou
- Povrch: chromováno, leštěno
- DIN 3123, ISO 3316

6.3 1/4 6.3 1/4



868-16 délka mimo řadu DIN/ISO

HAZET No.	l mm	EAN-No. 4000896+	€
868	147	038794	13,30
868-16	402	076727	18,20

871 Prodloužení · otočné

Made in Germany

- Kulovitý, kónický vnější čtyřhran úhel kyvu na každou stranu 8°

6.3 1/4 6.3 1/4

- Nasazením nástrčné hlavice až na doraz lze otočné prodloužení používat i jako pevné spojení
- S kuličkovou pojistkou
- Povrch: chromováno, leštěno

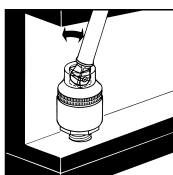

HAZET No.	l mm	EAN-No. 4000896+	€
871-1	25	038855	13,30
871-4	101,5	038879	16,30

870 Prodloužení · pružné

Made in Germany

- Flexibilní hřídel umožňuje práci s poníženými hranami, jakož i jistou a rychlou práci i ve stísněném prostoru
- S kuličkovou pojistkou

6.3 1/4 6.3 1/4



HAZET No.	l mm	EAN-No. 4000896+	€
870	150	038848	21,40

8508 S Adaptér pro rázový · strojový utahovák

Made in Germany

- ISO 1173-A 5,5
- Uchycení nástrčných klíčů pro strojní šroubováky s □ nástrčným otvorem 6,3 = 1/4"
- Použití ve strojním utahováku např. pro AEG, Bosch, Metabo
- S kolíkovou pojistkou
- DIN 3121, ISO 1173 A5,5

6.3 1/4



HAZET No.	l mm	EAN-No. 4000896+	€
8508 S-1	50	037391	17,10

Made in Germany

- ISO 1173-E 6,3 (1/4")
- S kolíkovou pojistkou
- DIN 3121, ISO 1173 E6,3 (1/4")

6.3 1/4 6.3 1/4



HAZET No.	l mm	EAN-No. 4000896+	€
8508 S-3	50	037414	15,-
8508 S-4	100	037421	19,20

10 3/8 Program nástrčných klíčů

880 Sada nástrčných klíčů

Made in Germany

- SmartCase (1/3) 165-L
- Safety-Insert-System, 2komponentní vložka z měkké pěny. Vložka vhodná také pro HAZET-Assistent

E TR 10 3/8

HiPer
HIGH PERFORMANCE
THE ORIGINAL
MADE IN GERMANY

HAZET SMART case

1/3				
-----	--	--	--	--



- 880 • 10 3/8 • 10 3/8
- 10 • 11 • 12 • 13
- 14 • 15 • 16 • 17
- 18 • 19 • 21 • 22

- 8816 HP • 10 3/8
- 8820 • 10 3/8 • 10 3/8

- 8821 • 10 3/8 • 10 3/8
- 8821-3 • 8821-6 • 8821-10

HAZET No.	d x š x v mm	□	EAN-No. 4000896+	€
880/17	355x235x65	17	168361	233,20

880 N Sada nástrčných klíčů

Made in Germany

- SmartCase (1/3) 165-L
- Safety-Insert-System, 2komponentní vložka z měkké pěny. Vložka vhodná také pro HAZET-Assistent

E TR 10 3/8

HiPer
HIGH PERFORMANCE
THE ORIGINAL
MADE IN GERMANY

HAZET SMART case

1/3				
-----	--	--	--	--



- 880 • 10 3/8 • 10 3/8
- 8 • 10 • 11 • 12 • 13 • 14
- 15 • 17 • 19 • 21 • 22

- 8815 • 10 3/8
- 8816 HP • 10 3/8

- 8820 • 10 3/8 • 10 3/8
- 8821 • 10 3/8 • 10 3/8
- 8821-5 • 8821-10

HAZET No.	d x š x v mm	□	EAN-No. 4000896+	€
880 N-1	355x235x65	16	040926	232,-



Ruční nářadí

10 3/8" Program nástrčných klíčů



880 Sada nástrčných klíčů

Made in Germany

- SmartCase (1/3) 165-L
- Safety-Insert-System, 2komponentní vložka z měkké pěny. Vložka vhodná také pro HAZET-Assistent



HiPer
HIGH PERFORMANCE
THE ORIGINAL
MADE IN GERMANY



- 880 • 10 3/8" • 10 3/8"
- 6 • 7 • 8 • 9 • 10
- 11 • 12 • 13 • 14 • 15
- 16 • 17 • 18 • 19 • 20
- 21 • 22

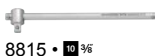

8815 • 10 3/8"



8820 • 10 3/8" • 10 3/8"

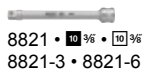

8821 • 10 3/8" • 10 3/8"
8821-3 • 8821-6

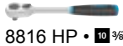

8816 HP • 10 3/8"

HAZET No.	d x š x v mm		EAN-No. 4000896+	€
880-2	355x235x65	22	039036	276,20

882 Sada nástrčných klíčů

Kombinovaná sada 6,3 = 1/4" a 10 = 3/8" nástavce a bity 6,3 = 1/4"



- SmartCase (1/3) 165-L
- Safety-Insert-System, 2komponentní vložka z měkké pěny. Vložka vhodná také pro HAZET-Assistent



360°

HiPer
HIGH PERFORMANCE
THE ORIGINAL
MADE IN GERMANY



- 850 • 6.3 1/4" • 6.3 1/4"
- 4 • 4.5 • 5 • 5.5
- 6 • 7 • 8 • 9
- 10 • 11 • 12 • 13



880 • 10 3/8" • 10 3/8"
- 10 • 11 • 12 • 13
- 14 • 15 • 16 • 17
- 18 • 19 • 21 • 22

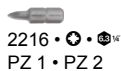

2216 • 6.3 1/4" • 6.3 1/4"
PZ 1 • PZ 2



2250-1 • 6.3 1/4" • 6.3 1/4"
2250-2 • 6.3 1/4" • 10 3/8"



863 HP • 6.3 1/4"

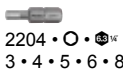

2204 • 6.3 1/4" • 6.3 1/4"
- 3 • 4 • 5 • 6 • 8

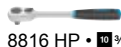

8816 HP • 10 3/8"

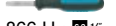

866 U • 6.3 1/4"

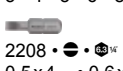

2208 • 6.3 1/4" • 6.3 1/4"
- 0.5x4 • 0.6x4.5
- 0.8x5.5 • 1x6



8820 • 10 3/8" • 10 3/8"



867-4 • 6.3 1/4" • 6.3 1/4"

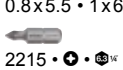

2215 • 6.3 1/4" • 6.3 1/4"
- PH 1 • PH 2



8821-6 • 10 3/8" • 10 3/8"



869 • 6.3 1/4" • 6.3 1/4"

HAZET No.	d x š x v mm		EAN-No. 4000896+	€
882	355x235x65	46	042289	435,80

882 Sada nástrčných klíčů

- SmartCase (1/3) 165-L
- Safety-Insert-System, 2komponentní vložka z měkké pěny. Vložka vhodná také pro HAZET-Assistent



HiPer
HIGH PERFORMANCE
THE ORIGINAL
MADE IN GERMANY

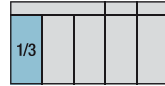

- 850 • 6.3 1/4" • 6.3 1/4"
- 6 • 7 • 8 • 9 • 10 • 13



880 • 10 3/8" • 10 3/8"
- 11 • 12 • 13 • 14 • 15 • 16
- 17 • 18 • 19 • 21 • 22



850 E • 6.3 1/4" • 6.3 1/4"
- E 6 • E 7 • E 8 • E 10



880 E • 10 3/8" • 10 3/8"
- E 11 • E 12 • E 14



863 HP • 6.3 1/4"

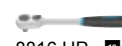

8816 HP • 10 3/8"



866 U • 6.3 1/4"



867-4 • 6.3 1/4" • 6.3 1/4"



8820 • 10 3/8" • 10 3/8"

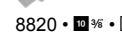

2250-1 • 6.3 1/4" • 6.3 1/4"
- 2250-3 • 6.3 1/4" • 10 3/8"



869 • 6.3 1/4" • 6.3 1/4"

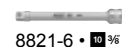

8821-6 • 10 3/8" • 10 3/8"

HAZET No.	d x š x v mm		EAN-No. 4000896+	€
882-1	355x235x65	46	100361	466,60

885 N Sada nástrčných klíčů

Made in Germany



- Nástrčné nástavce šroubováku s vrstvou CVD-TIN
- SmartCase (1/3) 165-L
- Safety-Insert-System, 2komponentní vložka z měkké pěny. Vložka vhodná také pro HAZET-Assistent

HiPer
HIGH PERFORMANCE
THE ORIGINAL
MADE IN GERMANY

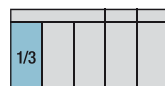

- 880 • 10 3/8" • 10 3/8"
- 6 • 7 • 8 • 9 • 10 • 11
- 12 • 13 • 14 • 15 • 16 • 17
- 18 • 19 • 21 • 22

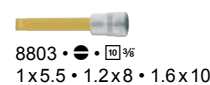

8803 • 10 3/8" • 10 3/8"
- 1 x 5.5 • 1.2 x 8 • 1.6 x 10



8801 • 10 3/8" • 10 3/8"
- 4 • 5 • 6 • 8

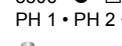

8806 • 10 3/8" • 10 3/8"
- PH 1 • PH 2 • PH 3

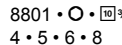

8815 • 10 3/8"



8821-3 • 8821-5 • 8821-10

HAZET No.	d x š x v mm		EAN-No. 4000896+	€
885 N	355x235x65	32	042593	421,10



880 ZN Sada nástrčných klíčů

Made in Germany

- Nástrčné hlavice dvojité 6hran
- SmartCase (1/3) 165-L
- Safety-Insert-System, 2komponentní vložka z měkké pěny. Vložka vhodná také pro HAZET-Assistent

E TR 10 3/8

HiPer
HIGH PERFORMANCE
THE ORIGINAL
MADE IN GERMANY

HAZET
SMART
case



1/3			
-----	--	--	--

880 • 8 • 10 3/8	880 Z • 10 • 11 • 12 • 13 • 14 • 15 • 17 • 19 • 21 • 22	8815 • 10 3/8	8820 • 10 3/8 • 10 3/8
8816 HP • 10 3/8	8821 • 10 3/8 • 10 3/8	8821-5 • 8821-10	

HAZET No.	d x Š x v mm		EAN-No. 4000896+	€
880 Z N-1	355x235x65	16	041992	232,-

888 ZN Sada nástrčných klíčů

Made in Germany

- Nástrčné hlavice dvojité 6hran
- Nástrčné nástavce šroubováku s vrstvou CVD-TIN
- Kovová schránka (modrá HAZET)
- 2komponentní měkká pěnová vložka

E TR 10 3/8

HiPer
HIGH PERFORMANCE
THE ORIGINAL
MADE IN GERMANY



880 • 8 • 10 3/8	8801 • 3 • 4 • 5 • 6 • 7 • 8 • 9 • 10 • 12	8815 • 10 3/8
880 Z • 9 • 10 • 11 • 12 • 13 • 14 • 15 • 16 • 17 • 18 • 19 • 20 • 21 • 22	8803 • 1x5.5 • 1.2x8 • 1.6x10	8816 HP • 10 3/8
880 TZ • 9 • 10 • 11 • 12 • 13 • 14 • 15 • 16 • 17 • 18 • 19 • 20 • 21 • 22	8806 • PH 2 • PH 3 • PH 4	8820 • 10 3/8 • 10 3/8
8814 • 10 3/8	8812 U • 10 3/8	8821 • 10 3/8 • 10 3/8
	8814 • 10 3/8	8821-3 • 8821-6
		8821-8 • 8821-12
		8830 • 10 3/8 • 10 3/8
		8858-2 • 1/4 • 1/4 • 10 3/8

HAZET No.	d x Š x v mm		EAN-No. 4000896+	€
888 ZN	578x235x88	58	042654	877,-

880 LG Sada nástrčných hlavíc

Made in Germany

- Jednoduchá montáž: 2 otvory, např. pro upevnění na zeď
- Velikost svorek přizpůsobená velikosti pohonu
- Povrch: chromováno, leštěno
- DIN 3124, ISO 2725-1



HAZET No.	l mm		EAN-No. 4000896+	€
• 10 šestihranných nástrčných hlavíc • Dlouhé provedení 880 LG • 10 • 11 • 12 • 13 • 14 • 15 • 16 • 17 • 18 • 19 880 Lg/10 H	240	10	040865	165,70
• 10 nástrčných hlavíc dvojité 6hran 880 TZ • 10 • 11 • 12 • 13 • 14 • 15 • 16 • 17 • 18 • 19 880 TZ/10 H	240	10	041831	165,70
• 10 šestihranných kloubových nástrčných hlavíc 880 G • 10 • 11 • 12 • 13 • 14 • 15 • 16 • 17 • 18 • 19 880 G/10 H	240	10	040612	359,-
• 8 nástrčných hlavíc pro šrouby s vnitřním šestihranem 8801 • 3 • 4 • 5 • 6 • 7 • 8 • 9 • 10 8801/8 H	240	8	039463	120,40
8802 • T 15 • T 20 • T 25 • T 27 • T 30 • T 40 • T 45 • T 50 8802 T/8 H	240	8	039784	107,40
• Prázdné, s 16 přídržnými svorkami • Uchycení nástrčných hlavíc řady 880 880 • 430		-	040650	9,35
880 HL	430	-	040650	9,35

8816 Přepínací ráčna

Made in Germany

- Počet zubů: 30
- Úhel ovládání: 12°
- S kuličkovou pojistkou
- 2komponentní rukojeť HAZET
- Povrch: chromováno, leštěno
- DIN 3122, ISO 3315

E 10 3/8



HAZET No.	l mm	EAN-No. 4000896+	€
8816 P	199	042203	51,50



Ruční nářadí

10 3/8" Program nástrčných klíčů



8816 Přepínací ráčna s kloubem

Made in Germany

- Ráčnová hlava otočná o >180°
- Krátké provedení
- Počet zubů: 30
- Úhel ovládání: 12°
- S kloubem – pro použití na těžko přístupných místech a pro obejítí rušivých hran
- S kuličkovou pojistkou
- 2komponentní rukojeť HAZET
- Povrch: chromováno, leštěno
- DIN 3122, ISO 3315

10 3/8"



Délka mimo normu

HAZET No.	l mm	EAN-No. 4000896+	€
8816 GK	218	042142	75,-

Made in Germany

- Ráčnová hlava otočná o >180°
- Dlouhé provedení
- Počet zubů: 30
- Úhel ovládání: 12°
- S kloubem – pro použití na těžko přístupných místech a pro obejítí rušivých hran
- S kuličkovou pojistkou
- 2komponentní rukojeť HAZET
- Povrch: chromováno, leštěno
- DIN 3122, ISO 3315

10 3/8"



Délka mimo normu

HAZET No.	l mm	EAN-No. 4000896+	€
8816 G	276	042104	75,-

8816 Přepínací ráčna · jemně ozubená

Made in Germany

- Extrémně větší výkon u ráčen se srovnatelnými rozměry

10 3/8"

- Aretační funkce páčky nabízí ochranu proti nechtěnému přepnutí
- Prodloužení životnosti použitím nejmodernějších maziv v ráčnovém mechanismu
- Úzké výrobní tolerance zaručují ochranu před vnikající nečistotou
- Interní standardy kvality HAZET zaručují zatížitelnost dalece nad normu
- Hodnotné, snadné čištění, odolné vůči korozi
- V rukojeti integrovaný prvek pro zavěšení
- VPA ověřený, statický utahovací moment dle DIN 3122: 400 Nm (DIN 202 Nm)
- Počet zubů: 90
- Úhel ovládání: 4°
- S kuličkovou pojistkou
- 2komponentní rukojeť HAZET
- Povrch: chromováno
- DIN 3122, ISO 3315



HiPer
HIGH PERFORMANCE
THE ORIGINAL
MADE IN GERMANY

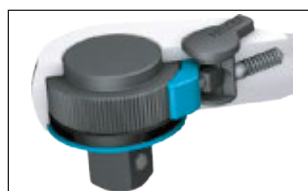

400 Nm
HiPer

90
4°

HAZET No.	l mm	EAN-No. 4000896+	€
8816 HP	200	235063	60,-

Opořebení? – Žádný problém!

- Nářadí HAZET je vyrobeno v nejvyšší kvalitě. Při dlouhém, intenzivním namáhání dochází i u vysoce kvalitních nástrojů k určitému opořebení.
- Proto nabízíme pro mnoho našich nástrojů náhradní díly a sady náhradních dílů.

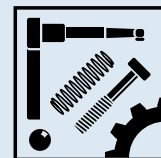

Nezapomeňte na náš obchod s náhradními díly
www.hazet.de/ersatzteil-shop

Úspora nákladů – udržitelnost – šetří zdroje!
Abyste se mohli ze svého nářadí HAZET dlouho těšit

8816 Sada náhradních dílů

Made in Germany

- Počet zubů: 30
- Úhel ovládání: 12°

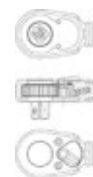

HAZET No.	EAN-No. 4000896+	€
8816 P/6	144617	8,15

- **Sada náhradních dílů ovládací páky** obsah sady: ovládací páka · šrouby · kulička · tlačná pružina · fixační prvek
Pro přepínací ráčnu HAZET 8816 G · 8816 GK · 8816 P · 8816 S · 8816 ST 916 K · 2264-1
Pro momentový klíč HAZET 5110-2 CT · 5120-2 CT · 5110-3 CT · 5111-3 CT · 5120-3 CT
6110 CT · 6110-1 CT · 6111-1 CT
6114-1 CT · 6115-1 CT
6402-1 · 6402-1 S · 6408-1

8816 P/6 144617 8,15

- **Sada náhradních dílů kolečka ráčny 10 = 3/8"** ■, obsah sady: kolečko ráčny · fixační prvek · ovládací páka · šrouby · kulička · tlačná pružina
Pro přepínací ráčnu HAZET 8816 G · 8816 GK · 8816 P · 8816 ST
Pro momentové klíče HAZET 5110-2 CT · 5110-3 CT · 5111-3 CT
6110 CT · 6110-1 CT · 6111-1 CT
6114-1 CT · 6115-1 CT · 6402-1

8816 P/7 N 042234 20,85

- **Sada náhradních dílů kolečka ráčny 10 = 3/8"** ■, obsah sady: kolečko ráčny se spouštěcím tlačítkem · fixační prvek · ovládací páka · šrouby · kulička · tlačná pružina
Pro přepínací ráčnu HAZET 8816 S · 6402-1 S a k přestavení přepínací ráčny HAZET 8816 P · 8816 G · 8816 GK · 8816 ST · 6110 CT · 6110-1 CT · 6111-1 CT · 6114-1 CT · 6115-1 CT · 6402-1

8816 S/7 048465 30,90

- **Plastová rukojeť**
Pro HAZET 8814 · 8816 P · 8816 F · 8816 G · 8816 GK · 2593 Lg-17

8816 KG-02 042166 2,40

- **Náhradní sada kloubového spojení** se skládá z/ze: šroubu a pružného kroužku
Pro kloubovou rukojeť HAZET 8814 a přepínací ráčnu HAZET 8816 G · 8816 GK

8816 G-013 042111 4,25

8814 Trhák s kloubem

Made in Germany

- S kloubem – pro použití na těžko přístupných místech a pro obejítí rušivých hran
- S kuličkovou pojistkou
- Ergonomická 2komponentní rukojeť HAZET
- Povrch: chromováno
- DIN 3122, ISO 3315

10 3/8"



HAZET No.	l mm	EAN-No. 4000896+	€
8814	250	042036	40,40



8812 U Zástrčná rukojeť

Made in Germany

- S kuličkovou pojistkou
- 2komponentní rukojeť HAZET
- Povrch: chromováno

10 3/8



HAZET No.	l mm	EAN-No. 4000896+	€
8812 U	137	067688	23,-

8815 Příčná rukojeť

Made in Germany

- S kuličkovou pojistkou
- Povrch: chromováno, leštěno
- DIN 3122, ISO 3315

10 3/8



HAZET No.	l mm	EAN-No. 4000896+	€
8815	198	042067	18,50

880 Nástrčná hlavice · šestihran

Made in Germany

- S rýhováním
- Povrch: chromováno, leštěno
- DIN 3124, ISO 2725-1

10 3/8

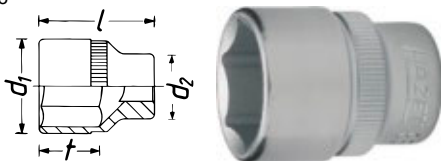

* = Mimo řady DIN

HAZET No.	l mm	d ₁ mm	d ₂ mm	f mm	EAN-No. 4000896+	€
880- 6 *	24	10	17	6,2	039104	7,50
880- 7	24	10,5	17	6,2	039111	7,50
880- 8	24	11,8	17	6,2	039128	7,50
880- 9	24	13	17	6,2	039135	7,50
880-10	25	14,4	17	7,2	038893	6,40
880-11	26	15,8	17,5	8,2	038916	7,50
880-12	27	17	18,5	9,2	038923	7,50
880-13	27,5	18,4	17	9,7	038930	6,40
880-14	29,5	19,5	17,5	11,7	038947	8,30
880-15	29,5	20,9	18	11,7	038954	8,30
880-16	29,5	22,1	18	11,7	038961	8,30
880-17	29,5	23,3	18,5	11,7	038978	9,60
880-18	31,5	24,8	19	13,5	038992	9,60
880-19	31,5	25,8	19,5	13,5	039005	9,60
880-20	31,5	26,8	21	13,5	039043	9,95
880-21	31,5	28,3	22,5	13	039050	9,95
880-22	34	29,6	23,5	16	039067	9,95

880 LG Nástrčná hlavice · šestihran

Made in Germany

- Dlouhé provedení
- S rýhováním
- Povrch: chromováno, leštěno
- DIN 3124, ISO 2725-1

10 3/8



880 LG Nástrčná hlavice · šestihran

10 3/8

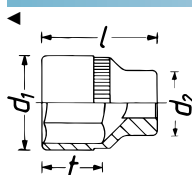

HAZET No.	l mm	d ₁ mm	d ₂ mm	f mm	EAN-No. 4000896+	€
880 Lg- 8	54	12,1	17	7	052257	15,70
880 Lg- 9	54	13	17	10	040858	15,70
880 Lg-10	54	14,4	17	10	040698	15,70
880 Lg-11	54	15,8	17,2	11	040704	15,70
880 Lg-12	54	17	18,5	11	040711	15,70
880 Lg-13	54	18,4	18,5	12	040728	15,70
880 Lg-14	54	19,5	19,5	15	040759	15,70
880 Lg-15	60	20,8	19,5	15	040766	15,70
880 Lg-16	60	21,8	18,5	16	040773	15,70
880 Lg-17	60	23	18,5	16	040780	16,50
880 Lg-18	66	24,4	20	20	040797	16,50
880 Lg-19	66	25,5	20	20	040803	17,30
880 Lg-20	70	26,6	21	22	040810	18,10
880 Lg-21	70	28	22	22	040834	18,55
880 Lg-22	70	29,6	21	22	040841	18,55

880 Z Nástrčná hlavice · dvojitý 6hran

Made in Germany

- S rýhováním
- Povrch: chromováno, leštěno
- DIN 3124, ISO 2725-1

10 3/8

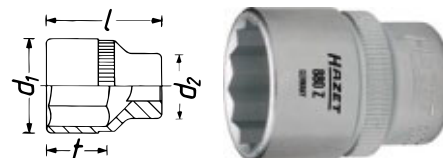

HAZET No.	l mm	d ₁ mm	d ₂ mm	f mm	EAN-No. 4000896+	€
880 Z- 9	24	13	17	6,2	041985	7,50
880 Z-10	25	14,4	17	7,2	041848	6,40
880 Z-11	26	15,8	17,5	8,2	041855	7,50
880 Z-12	27	17	18,5	9,2	041862	7,50
880 Z-13	27,5	18,4	17	9,7	041879	6,40
880 Z-14	29,5	19,6	17,5	11,7	041893	8,30
880 Z-15	29,5	20,9	18	11,7	041909	8,30
880 Z-16	29,5	22,1	18	11,7	041916	8,30
880 Z-17	29,5	23,3	18,5	11,7	041923	9,60
880 Z-18	31,5	24,6	19	13,5	041930	9,60
880 Z-19	31,5	25,8	19,5	13,5	041947	9,60
880 Z-20	31,5	26,8	20	13,5	041954	9,95
880 Z-21	31,5	28,3	22,5	13	041961	9,95
880 Z-22	34	29,6	23,5	15,5	041978	9,95

960 MGT Magnetická vložka pro nástrčné klíče

- Univerzálně použitelné v metrických nástrčných hlavících s 6hranem a dvojitým 6hranem s 10 až 19 mm

- Plastové vložky s integrovaným magnetem
- Vysoká přídržná síla
- Opakované použití
- 10dílná sada, pro metrické nástrčné klíče s 10 · 11 · 12 · 13 · 14 · 15 · 16 · 17 · 18 · 19 mm
- DIN 3124, ISO 2725-1

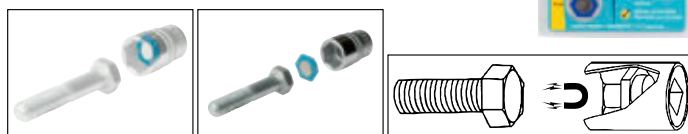

HAZET No.	EAN-No. 4000896+	€
960 Mgt	097661	23,80



Ruční nářadí

10 3/8 Program nástrčných klíčů



880 A Nástrčná hlavice · dvojitý 6hran

Made in Germany

- Americké rozměry
- S rýhováním
- Povrch: chromováno, leštěno
- DIN 3124, ISO 2725-1

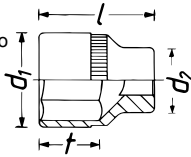

10 3/8

Velikost 1/4" a 5/16" se šestihranem

HAZET No.	l mm	d ₁ mm	d ₂ mm	EAN-No. 4000896+	€
880 A- 1/4	24	10	17	040056	7,50
880 A- 5/16	24	11,8	17	040094	7,50
880 AZ- 3/8	25	13,8	17	040360	7,50
880 AZ- 7/16	26	15,8	17,5	040384	7,50
880 AZ- 1/2	27,5	18,7	17	040292	7,50
880 AZ- 9/16	29,5	20,1	17,5	040407	8,35
880 AZ- 19/32	29,5	21,1	18	040339	8,35
880 AZ- 5/8	29,5	22,1	18	040377	8,35
880 AZ- 11/16	29,5	23,8	18,5	040308	9,60
880 AZ- 3/4	31,5	25,8	19,5	040353	9,60
880 AZ- 25/32	31,5	26,8	21	040346	9,95
880 AZ- 13/16	32	28,3	22,5	040315	9,95
880 AZ- 7/8	34	30,3	23,5	040391	9,95
880 AZ- 15/16	36,5	32,3	23,5	040322	9,95

880 TZ Nástrčná hlavice · dvojitý 6hran

Made in Germany

- Dlouhé provedení
- S rýhováním
- Povrch: chromováno, leštěno
- DIN 3124, ISO 2725-1

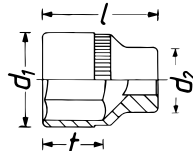

10 3/8

HAZET No.	l mm	d ₁ mm	d ₂ mm	t mm	EAN-No. 4000896+	€
880 TZ- 9	54	13	17	10	041824	15,70
880 TZ-10	54	14,4	17	10	041602	15,70
880 TZ-11	54	15,8	17,2	11	041626	15,70
880 TZ-12	54	17	18,5	12,3	041633	15,70
880 TZ-13	54	18,4	18,5	12	041664	15,70
880 TZ-14	54	19,5	19,5	15	041688	15,70
880 TZ-15	60	20,8	19,5	15	041701	15,70
880 TZ-16	60	21,8	18,5	16	041718	15,70
880 TZ-17	60	23	18,5	16	041725	16,50
880 TZ-18	66	24,4	20	20	041749	16,50
880 TZ-19	66	25,5	20	20	041756	17,30
880 TZ-20	70	26,6	21	22	041763	18,10
880 TZ-21	70	28	22	22	041794	18,55
880 TZ-22	70	29,6	21	22	041800	18,55

848 Z Očkový klíč · dvojitý 6hran · otevřený

Made in Germany

- Pentagramový klíč
- Pro převlečné matice a trubková šroubení
- Čtyřhranné uchycení



YouTube Clip

HAZET No.	l mm	d ₁ mm	d ₂ mm	t mm	EAN-No. 4000896+	€
880 G-Z 16	45,8	22	19	10	203734	37,05
880 G-Z 18	46,8	24,5	19	11	203529	37,05

848 Z Očkový klíč · dvojitý 6hran · otevřený

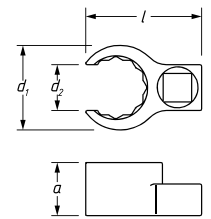

HAZET No.	l mm	d ₁ mm	d ₂ mm	a mm	mm	EAN-No. 4000896+	€
848 Z-17	40,9	27,5	14,5	18	□ 10 = 3/8"	079094	54,75
848 Z-18	41,7	29	15	19	□ 10 = 3/8"	079100	54,75
848 Z-19	41,9	30	16	19	□ 10 = 3/8"	079117	53,75
848 Z-21	46	32	16,5	19	□ 10 = 3/8"	079124	55,70
848 Z-22	46,5	33,5	17,5	19,5	□ 10 = 3/8"	079131	55,70
848 Z-24	50	36,5	18,5	20	□ 10 = 3/8"	079148	55,70
848 Z-27	53,7	40,5	20,5	22	□ 10 = 3/8"	079162	59,95
848 Z-30	62,4	46,5	25	23	□ 12,5 = 1/2"	079179	69,70
848 Z-32	63,7	48,5	24,5	23	□ 12,5 = 1/2"	079186	72,45
848 Z-36	67,1	52,5	27,5	24,5	□ 12,5 = 1/2"	079193	74,90
848 Z-41	74,1	58,5	31	24,5	□ 12,5 = 1/2"	079216	81,75
848 Z-46	77,7	64,5	35,5	26,5	□ 12,5 = 1/2"	079223	92,50

880 G Kloubová nástrčná hlavice · šestihran

Made in Germany

- S kloubem – pro použití na těžko přístupných místech a pro obejití rušivých hran
- Povrch: chromováno, leštěno
- DIN 3124, ISO 2725-1

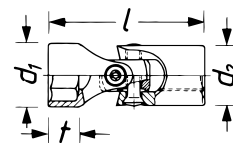

10 3/8

HAZET No.	l mm	d ₁ mm	d ₂ mm	t mm	EAN-No. 4000896+	€
880 G-10	43	13,8	19	6,8	040414	34,-
880 G-11	43	15	19	6,8	040438	34,-
880 G-12	44	16,6	19	7,3	040445	34,-
880 G-13	44	17,8	19	7,3	040452	34,-
880 G-14	45	19	19	9,3	040469	34,-
880 G-15	45	20,4	19	9,3	040476	34,-
880 G-16	46	22	19	9,2	040483	37,05
880 G-17	46	22,8	19	9,2	040490	37,05
880 G-18	47	24,5	19	10,2	040506	37,05
880 G-19	48	25,2	19	11,2	040513	37,05

880 GZ Kloubová nástrčná hlavice · dvojitý šestihran

Made in Germany

- S kloubem – pro použití na těžko přístupných místech a pro obejití rušivých hran
- S kuličkovou pojistkou
- Povrch: chromováno, leštěno
- DIN 3124, ISO 2725-1

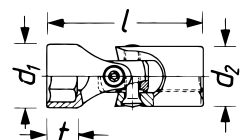

10 3/8



880 MGT Nástrčná hlavice na zapalovací svíčky

Made in Germany

- S permanentním magnetem
- Dlouhé provedení
- **Americké rozměry**
- Povrch: chromováno, leštěno
- DIN 3124, ISO 2725-1

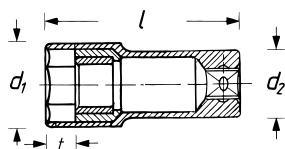
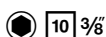

HAZET No.	S mm	S" mm	l mm	d ₁ mm	d ₂ mm	t mm	EAN-No. 4000896+	€
880 Mg T	20,8	13/16	64	27,4	22,5	9	040872	20,15
880 A Mg T	16	5/8	64	21,6	21,6	9	040247	20,15

Made in Germany

- S permanentním magnetem



- Vnější šestihran 17 mm
- Např. pro motocykly HONDA · YAMAHA · SUZUKI · KAWASAKI atd.
- Dlouhé provedení
- Povrch: chromováno, leštěno
- DIN 3124, ISO 2725-1

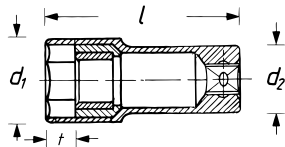

HAZET No.	S mm	l mm	d ₁ mm	d ₂ mm	t mm	EAN-No. 4000896+	€
880 Mg T-18	18	62	23,5	22,8	9,6	040889	20,15

880 AMGT Nástrčná hlavice na zapalovací svíčky

Made in Germany

- Vnější vodící kroužek 23,6 mm pro hluboko uložené zapalovací svíčky



- S permanentním magnetem
- Dlouhé provedení
- **Americké rozměry**
- Povrch: chromováno, leštěno
- DIN 3124, ISO 2725-1

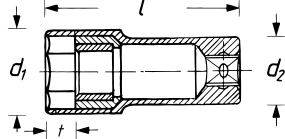

HAZET No.	S mm	S" mm	l mm	d ₁ mm	d ₂ mm	t mm	EAN-No. 4000896+	€
880 A Mg T-1	16	5/8	64	21,9	21	9	040254	20,15

Informace – korunková pružina

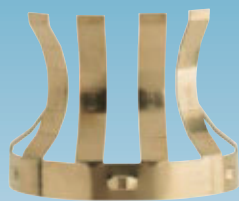
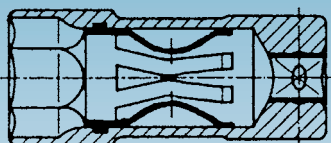

- Korozi-vzdorná a odolná proti teplu
- Maximální volnost keramického izolátoru
- 6 pružících prvků – bezpečná opora zapalovacích svíček
- Tlumení příčných pohybů

880 KF Nástrčná hlavice na zapalovací svíčky

Made in Germany

- Korunková pružina zmenšuje riziko poškození izolátoru



- Korunková pružina jako přidržný mechanismus
- Dlouhé provedení
- **Americké rozměry**
- Povrch: chromováno, leštěno
- DIN 3124, ISO 2725-1

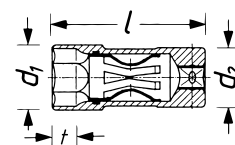

HAZET No.	S mm	S" mm	l mm	d ₁ mm	d ₂ mm	t mm	EAN-No. 4000896+	€
880 KF	20,8	13/16	64	27,4	25	10	040674	15,90
880 A KF	16	5/8	64	21,6	21,6	10	040131	15,90

HAZET No.	S mm	S" mm	l mm	d ₁ mm	d ₂ mm	t mm	EAN-No. 4000896+	€
4766	16	5/8	97	21,4	18	10	049295	37,05
4766-1	16	5/8	270	21,4	18	10	048991	41,35
4766-2	14		64	18	17,3	10	087655	25,45
4766-3	14		154	19,1	18	10	199976	51,90

880 KF Korunková pružina

Made in Germany

- Americké rozměry



HAZET No.	EAN-No. 4000896+	€
• Korunková pružina pro klíč na zapalovací svíčky HAZET 880 KF · 900 KF · 4767 KF		
880 KF-01	050123	2,50
• Korunková pružina pro klíč na zapalovací svíčky HAZET 880 A KF · 900 A KF · 4766 · 4766-1 · 4767 A KF		
880 A KF-01	050130	2,50

880 E Nástrčná hlavice TORX®

Made in Germany

- S rýhovaním
- Povrch: chromováno, leštěno
- DIN 3124, ISO 2725-1

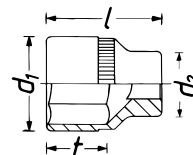
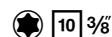

HAZET No.	l mm	d ₁ mm	d ₂ mm	mm	EAN-No. 4000896+	€
880-E 5	28	7	17	4,75	039258	10,60
880-E 6	28	8	17	5,74	039272	10,60
880-E 7	28	9	17	6,22	039296	10,60
880-E 8	28	10,5	17	7,52	039319	10,60
880-E 10	28	13	17	9,42	039159	10,60
880-E 11	28	14	17	10,08	039180	11,30
880-E 12	28	14,9	17	11,17	039197	11,40
880-E 14	28	16,5	18,5	12,90	039227	11,75



Ruční nářadí

10 3/8 Program nástrčných klíčů



880 LG-E Nástrčná hlavice TORX®

Made in Germany

- Dlouhé provedení
- Povrch: chromováno, leštěno
- DIN 3124, ISO 2725-1

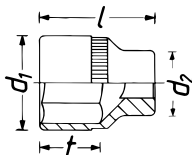

HAZET No.	l mm	d ₁ mm	d ₂ mm	mm	EAN-No. 4000896+	€
880 Lg-E 8	65	10,5	17	7,52	053070	19,15
880 Lg-E 10	65	13	17	9,42	053087	19,15
880 Lg-E 12	65	14,9	17	11,17	053100	20,35
880 Lg-E 14	65	16,5	18,5	12,90	053117	21,40

880 G-E Nástrčná hlavice TORX®

Made in Germany

- S kloubem – pro použití na těžko přístupných místech a pro obehnutí rušivých hran
- Povrch: chromováno, leštěno
- DIN 3124, ISO 2725-1



880 G-E Nástrčná hlavice TORX®

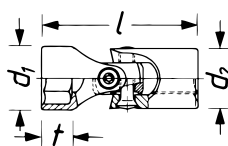

HAZET No.	l mm	d ₁ mm	d ₂ mm	mm	EAN-No. 4000896+	€
880 G-E 8	43	11,5	19	7,52	040599	35,75
880 G-E 10	44	13,8	19	9,42	040537	35,75
880 G-E 12	46	16	19	11,17	040551	35,75
880 G-E 14	48	17,8	19	12,90	040575	35,75

880 G-E Sada nástrčných hlavice TORX®

Made in Germany

- S kloubem – pro použití na těžko přístupných místech a pro obehnutí rušivých hran
- Povrch: chromováno, leštěno



880 G-E • 10 3/8
E 8 • E 10 • E 12 • E 14

HAZET No.	mm	EAN-No. 4000896+	€
880 G-E/4	4	040520	144,50

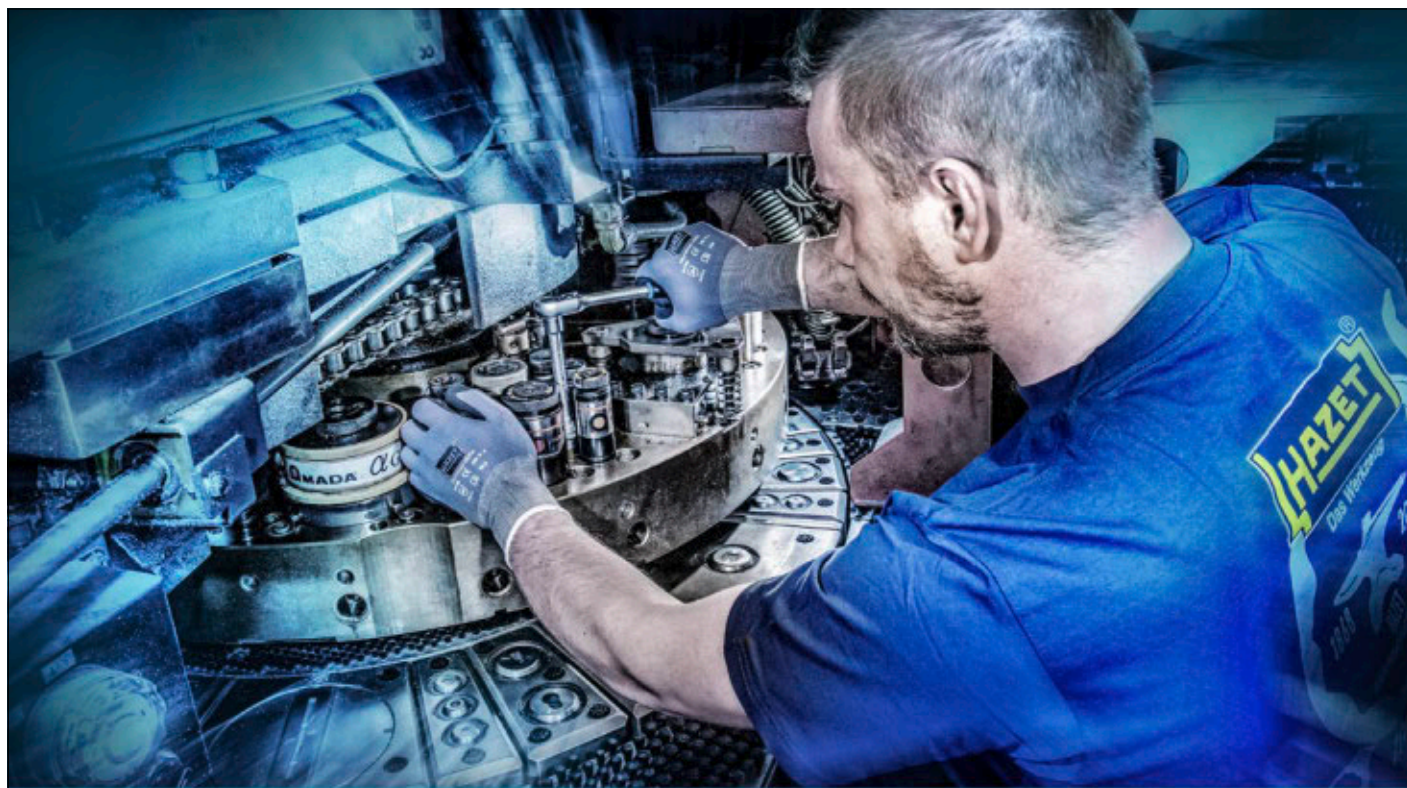



Povrchová úprava TiN

TiN

Proč povrchová úprava TiN (nitrid titanu)?

- Speciální metoda velmi tvrdé povrchové úpravy TiN dosahuje extrémně vysoké přilnavosti a otěruvzdornosti vrstvy
- Optimálně vhodné při dlouhodobém zatížení, např. sériovém šroubování v průmyslu a dílnách
- Vyšší ochrana proti opotřebení zajišťuje delší životnost
- Perfektní přesnost díky optimální tloušťce vrstvy
- Vyšší utahovací moment
- Optimální ochrana proti korozi

Nástrčné hlavice s TiN úpravou

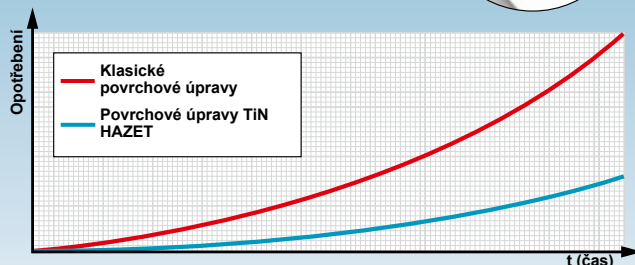
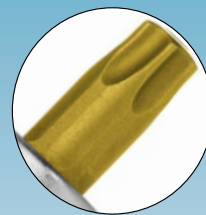

8801 K Nástrčná hlavice

Made in Germany

- Extra krátké provedení
- S rýhováním
- Povrch: **TiN**
- DIN 7422, DIN 3124, ISO 2725-1

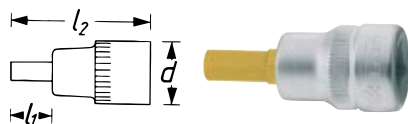

TiN 10 3/8

* = Mimo řady DIN

HAZET No.	S mm	l ₁ mm	l ₂ mm	d mm	EAN-No. 4000896+	€
8801 K- 3	3	17	43,5	17	053582	10,45
8801 K- 4 *	4	17	43,5	17	053599	10,45
8801 K- 5	5	17	43,5	17	053605	10,45
8801 K- 6	6	17	43,5	17	053612	10,45
8801 K- 7	7	17	43,5	19	053629	11,45
8801 K- 8	8	17	43,5	19	053636	11,45
8801 K- 9 *	9	17	43,5	19	053643	13,75
8801 K-10	10	17	43,5	19	053650	13,75

8801 Nástrčná hlavice

Made in Germany

- Krátké provedení
- S rýhováním
- Povrch: **TiN**
- DIN 7422, DIN 3124, ISO 2725-1

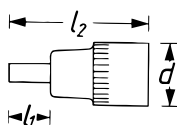

TiN 10 3/8

s 3–9–12: mimo řady DIN
+ = S odsazeným bitem

HAZET No.	S mm	l ₁ mm	l ₂ mm	d mm	EAN-No. 4000896+	€
8801- 3 +	3	23,5	50	17	039364	13,20
8801- 4 +	4	28,5	55	17	039371	13,45
8801- 5 +	5	33,5	60	17	039388	13,50
8801- 6	6	38,5	65	17	039395	13,75
8801- 7 +	7	43,5	70	19	039401	14,30
8801- 8	8	48,5	75	19	039425	14,30
8801- 9 +	9	52,5	80	19	039432	17,30
8801-10	10	57,5	85	19	039340	17,30
8801-11	11	60	87,5	19	166299	17,50
8801-12	12	62,5	90	19	039357	20,10

HAZET No.	S mm	l ₁ mm	l ₂ mm	EAN-No. 4000896+	€
2584-8	8	6,6	24	149438	14,60
2784-1	7	6,6	24	148530	14,60

8801 Sada nástrčných hlavíc

Made in Germany

- Krátké provedení
- S rýhováním
- SmartCase (1/9) 165-S
- Safety-Insert-System, 2komponentní vložka z měkké pěny. Vložka vhodná také pro HAZET-Assistent
- Povrch: **TiN**
- DIN 7422

TiN 10 3/8

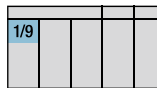

8801 • 3/8
4 • 5 • 6 • 7 • 8 • 10

HAZET No.	d x š x v mm		EAN-No. 4000896+	€
8801/6	185x153x52	6	186853	90,60

8801 A Nástrčná hlavice

Made in Germany

- Krátké provedení
- Americké rozměry
- S rýhováním
- Povrch: **TiN**
- DIN 3124, ISO 2725-1

TiN 10 3/8

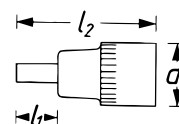

+ = S odsazenou čepelí

HAZET No.	l ₁ mm	l ₂ mm	d mm	EAN-No. 4000896+	€
8801 A-1/8 +	23,5	50	17	039487	13,20
8801 A-5/32 +	28,5	55	17	039524	13,45
8801 A-3/16 +	33,5	60	17	039494	13,50
8801 A-7/32 +	38,5	65	17	039531	13,75
8801 A-1/4 +	43,5	70	19	039470	13,75
8801 A-5/16	48,5	75	19	039517	14,30
8801 A-3/8 +	52,5	80	19	039500	17,30



8801 KK Nástrčná hlavice

Made in Germany

- Dlouhé provedení
- S kulovou hlavou
- S rýhováním
- Povrch:
- DIN 3124, ISO 2725-1

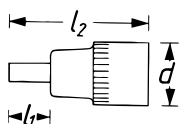

HAZET No.	S mm	l ₁ mm	l ₂ mm	d mm	EAN-No. 4000896+	€
8801 KK- 5	5	89,5	116	17	039586	15,05
8801 KK- 6	6	89,5	116	17	039593	15,75
8801 KK- 7	7	89,5	116	19	039609	17,-
8801 KK- 8	8	89,5	116	19	039616	18,20
8801 KK-10	10	88,5	116	19	039579	22,95

HAZET No.	S mm	l ₁ mm	l ₂ mm	EAN-No. 4000896+	€
2527-5	5	200	227	016303	24,95

8802 Nástrčná hlavice TORX®

Made in Germany

- Krátké provedení
- S rýhováním
- Povrch:

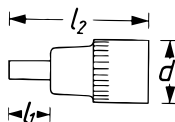
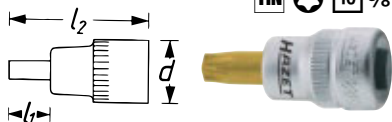

HAZET No.	l ₁ mm	l ₂ mm	d mm	⌀ mm	EAN-No. 4000896+	€
8802-T 15	17	43,5	19	3,27	039647	12,35
8802-T 20	17	43,5	19	3,86	039654	12,35
8802-T 25	17	43,5	19	4,43	039661	12,35
8802-T 27	17	43,5	19	4,99	039678	12,50
8802-T 30	17	43,5	19	5,52	039685	12,50
8802-T 40	17	43,5	19	6,65	039708	13,20
8802-T 45	17	43,5	19	7,82	039722	13,20
8802-T 50	17	44,5	19	8,83	039753	14,30

8803 Nástrčná hlavice

Made in Germany

- Středně dlouhé provedení
- S rýhováním
- Povrch:
- DIN ISO 2380-1, DIN 3124, ISO 2725-1

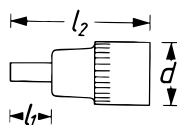

HAZET No.	l ₁ mm	l ₂ mm	d mm	EAN-No. 4000896+	€
8803-1x5.5	48,5	75	17	039814	16,15
8803-1.2x8	53,5	80	19	039791	18,10
8803-1.6x10	62,5	90	19	039807	20,50

8806 Nástrčná hlavice

Made in Germany

- Krátké provedení
- S rýhováním
- Povrch:
- Špička ISO 8764-1, DIN 3124, ISO 2725-1

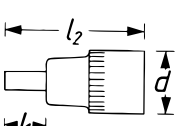
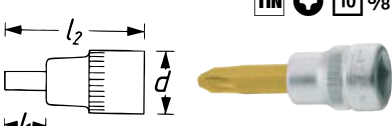

HAZET No.	l ₁ mm	l ₂ mm	d mm	EAN-No. 4000896+	€
8806-PH 1	23,5	50	17	039845	13,45
8806-PH 2	23,5	50	17	039852	13,75
8806-PH 3	28,5	55	19	039869	14,55
8806-PH 4	32,5	60	19	039876	16,50

8808 Nástrčná hlavice

Made in Germany

- Krátké provedení
- S rýhováním
- Povrch:
- DIN 2324, DIN 2325, DIN 3124, ISO 2725-1

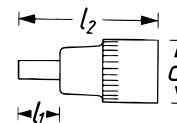
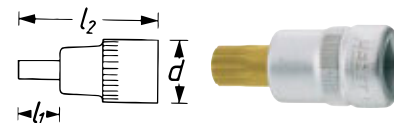

HAZET No.	l ₁ mm	l ₂ mm	d mm	EAN-No. 4000896+	€
8808- 5	13,5	40	19	039982	17,-
8808- 6	13,5	40	19	039999	17,-
8808- 8	14,5	41	19	040001	17,-
8808-10	14,5	42	19	039975	18,95

8808 LG Nástrčná hlavice

Made in Germany

- Dlouhé provedení
- S rýhováním
- Povrch:
- DIN 2324, DIN 2325, DIN 3124, ISO 2725-1

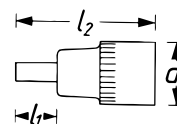

HAZET No.	l ₁ mm	l ₂ mm	d mm	EAN-No. 4000896+	€
8808 Lg- 6	62,3	89	19	204946	17,80
8808 Lg- 8	61,5	88	19	040025	19,40
8808 Lg-10	61,5	89	19	040018	21,-

8858 Adaptér

Made in Germany

- S kuličkovou pojistkou
- Povrch: chromováno
- DIN 3123, ISO 3316



HAZET No.	l mm	EAN-No. 4000896+	€
• Pohon 12,5 = 1/2" – pohon 10 = 3/8"			
8858-1	36	042562	13,95
• Pohon 6,3 = 1/4" – pohon 10 = 3/8"			
8858-2	26	042579	10,95

2250 Adaptér

Made in Germany

- Pro ruční manipulaci
- Uchycení vnitřní 4hran a vnitřní 6hran
- Přídržná kulička pro bity
- Povrch: chromováno



HAZET No.	l mm	EAN-No. 4000896+	€
• 6,3 = 1/4" – 10 = 3/8"			
2250-2	30	015450	15,95
• 8 = 5/16" – 10 = 3/8"			
2250-3	31	015474	16,20



8820 Univerzální kloub

Made in Germany

- S kloubem – pro použití na těžko přístupných místech a pro obejití rušivých hran
- S kuličkovou pojistkou
- Povrch: chromováno, leštěná hlava
- DIN 3123, ISO 3316

10 3/8" 10 3/8"



HAZET No.	l mm	EAN-No. 4000896+	€
8820	46,5	042296	27,85

8821 Prodloužení

Made in Germany

- S kuličkovou pojistkou
- Povrch: chromováno, leštěná hlava
- DIN 3123, ISO 3316

10 3/8" 10 3/8"



* = délka mimo řadu DIN

HAZET No.	l mm	EAN-No. 4000896+	€
8821- 1 *	36	042302	13,70
8821- 3	74	042357	14,60
8821- 5	126	042364	15,45
8821- 6 *	150	042371	15,75
8821- 8 *	202	042388	19,85
8821-10	254	042319	21,25
8821-12 *	304	042326	22,70
8821-20 *	508	042333	42,85
8821-28 *	711	042340	46,50

8822 Prodloužení · otočné

Made in Germany

- Kulovitý, kónický vnější čtyřhran úhel kyvu na každou stranu 8°

10 3/8" 10 3/8"

- Nasazením nástrčné hlavice až na doraz lze otočné prodloužení používat i jako pevné spojení
- S kuličkovou pojistkou
- Povrch: chromováno, leštěno

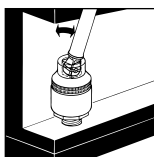

HAZET No.	l mm	EAN-No. 4000896+	€
8822- 1	36	042418	15,75
8822- 3	74	042432	18,35
8822-10	254	042425	28,25

8830 Ohebné prodloužení

Made in Germany

- Flexibilní hřídel umožňuje práci s poničenými hranami, jakož i jistou a rychlou práci i ve stísněném prostoru
- S kuličkovou pojistkou

10 3/8" 10 3/8"



HAZET No.	l mm	EAN-No. 4000896+	€
8830	210	042487	28,-

880 SE Nástrčná hlavice pro rázový · strojový uťahovák · TORX®

Made in Germany

- S otvorem pro pojistný kolík nebo zajišťovací pružinu a drážku pro O-kroužek
- Povrch: fosfátováno, olejováno
- DIN 3124, ISO 2725-2

10 3/8"

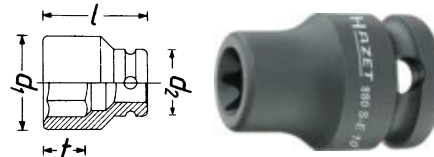

HAZET No.	l mm	d ₁ mm	d ₂ mm	mm	EAN-No. 4000896+	€
880 S-E 10	28	14	19	9,42	041237	11,35
880 S-E 12	28	15,9	19	11,17	041251	11,35

8807 S Adaptér pro rázový · strojový uťahovák

Made in Germany

- Pohon s otvorem pro kolíkovou pojistku a drážkou pro O-kroužek, výstup s kolíkovou pojistkou
- Povrch: fosfátováno, olejováno

10 3/8"



HAZET No.	l mm	d mm	EAN-No. 4000896+	€
8807 S	28	22	039937	11,45
8807 S-1	35,5	22	039951	14,60

8808 S Adaptér pro rázový · strojový uťahovák

Made in Germany

- Uchycení nástrčných klíčů pro strojní šroubováky s □ nástrčným otvorem 10 = 3/8"
- S kolíkovou pojistkou
- Povrch: ocelově šedý, olejovaný

10 3/8" 8 5/16"



HAZET No.	l mm	EAN-No. 4000896+	€
8808 S-1	75	040032	26,70

880 S Pojistná pružina

Made in Germany

- Pro strojně ovládané nástavce nástrčných klíčů podle DIN 3129



HAZET No.	mm	EAN-No. 4000896+	€
880 S-HF 612	Ø 16,6	041428	3,55
880 S-HF 1319	Ø 18,0	041411	3,55



Ruční nářadí

125 1/2 Program nástrčných klíčů



125 1/2 Program nástrčných klíčů

900 Sada nástrčných klíčů

Made in Germany

- SmartCase (1/3) 165-L
- Safety-Insert-System, 2komponentní vložka z měkké pěny. Vložka vhodná také pro HAZET-Assistent



HiPer
HIGH PERFORMANCE
THE ORIGINAL
MADE IN GERMANY



360°



900 • 125 1/2
10 • 11 • 12 • 13 • 14
15 • 16 • 17 • 18 • 19
20 • 21 • 22 • 23 • 24
26 • 27 • 28 • 30 • 32

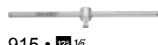

915 • 125 1/2

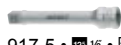

917-5 • 125 1/2 • 125 1/2

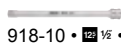

918-10 • 125 1/2 • 125 1/2

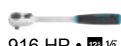

916 HP • 125 1/2



920 • 125 1/2 • 125 1/2

HAZET No.	d x š x v mm		EAN-No. 4000896+	€
900	355x235x65	25	042685	362,40

906 Sada nástrčných klíčů

Made in Germany

- SmartCase (1/3) 165-L
- Safety-Insert-System, 2komponentní vložka z měkké pěny. Vložka vhodná také pro HAZET-Assistent



HiPer
HIGH PERFORMANCE
THE ORIGINAL
MADE IN GERMANY



900 • 125 1/2
10 • 11 • 12 • 13 • 14
15 • 17 • 19 • 22 • 24
27 • 30 • 32



915 • 125 1/2

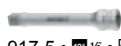

917-5 • 125 1/2 • 125 1/2



916 HP • 125 1/2



918-10 • 125 1/2 • 125 1/2

HAZET No.	d x š x v mm		EAN-No. 4000896+	€
906	355x235x65	17	045891	293,90

953 HP Sada nástrčných klíčů

S jemnozubou přepínací

- ráčnou HiPer 916 HP:
 - Symbióza výkonu a přesnosti
 - 90 zubů, 4 stupně úhel ovládní



- SmartCase (1/3) 165-L
- Safety-Insert-System, 2komponentní vložka z měkké pěny. Vložka vhodná také pro HAZET-Assistent

HiPer
HIGH PERFORMANCE
THE ORIGINAL
MADE IN GERMANY



850 • 125 1/2
5 • 6 • 7 • 8 • 9
10 • 11 • 12 • 13



900 • 125 1/2
10 • 11 • 12 • 13 • 14
15 • 16 • 17 • 18 • 19
21 • 22 • 24 • 27



2208 • 125 1/2

0.5x4 • 0.6x4.5 • 0.8x5.5
2215 • 125 1/2
PH 1 • PH 2



863 HP • 125 1/2

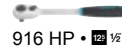

916 HP • 125 1/2

2216 • 125 1/2
PZ 1 • PZ 2



866 U • 125 1/2

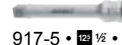

917-5 • 125 1/2 • 125 1/2

2223 • 125 1/2
T 10 • T 15 • T 20
T 25 • T 30

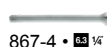

867-4 • 125 1/2 • 125 1/2

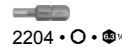

2204 • 125 1/2 • 125 1/2
2 • 3 • 4 • 5 • 6



2250-1 • 125 1/2

HAZET No.	d x š x v mm		EAN-No. 4000896+	€
953 HP	355x235x65	47	215188	274,-

954 N Sada nástrčných klíčů

- Navíc s nástrčnými nastavi šroubováků (s vrstvou CVD-TIN), bity a adaptérem



- SmartCase (1/3) 165-L
- Safety-Insert-System, 2komponentní vložka z měkké pěny. Vložka vhodná také pro HAZET-Assistent

HiPer
HIGH PERFORMANCE
THE ORIGINAL
MADE IN GERMANY



900 • 125 1/2
10 • 11 • 12 • 13 • 14
15 • 17 • 19 • 20 • 21
22 • 23 • 24 • 26 • 27
28 • 30 • 32

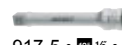

917-5 • 125 1/2 • 125 1/2

2217 • 125 1/2
PH 1 • PH 2 • PH 3 • PH 4

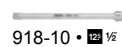

918-10 • 125 1/2 • 125 1/2

2218 • 125 1/2
PZ 1 • PZ 2 • PZ 3 • PZ 4



915 • 125 1/2



920 • 125 1/2 • 125 1/2

2224 • 125 1/2
T 27 • T 30 • T 40
T 45 • T 50



916 HP • 125 1/2



986 • 125 1/2
5 • 6 • 7 • 8 • 10 • 12 • 14



2250-5 • 125 1/2

HAZET No.	d x š x v mm		EAN-No. 4000896+	€
954 N	355x235x65	44	046621	501,-



905 Sada nástrčných klíčů

Made in Germany

- Kovová schránka (modrá HAZET)
- 2komponentní měkká pěnová vložka

E 125 1/2



HiPer
HIGH PERFORMANCE
THE ORIGINAL
MADE IN GERMANY



900 • • 1/2

8 • 9 • 10 • 11 • 12
13 • 14 • 15 • 16 • 17
18 • 19 • 20 • 21 • 22
23 • 24 • 25 • 26 • 27
28 • 30 • 32

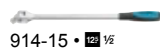

914-15 • 1/2



915 • 1/2



916 HP • 1/2



917-5 • 1/2 • 1/2

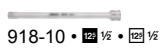

918-10 • 1/2 • 1/2



920 • 1/2 • 1/2



980 • • 1/2

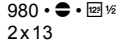

2 x 13

HAZET No.	d x š x v mm		EAN-No. 4000896+	€
905	435x215x62	30	045846	477,10

900 Z Sada nástrčných klíčů

Made in Germany

- S nástrčnými hlavici s dvojitým 6hranem
- SmartCase (1/3) 165-L
- Safety-Insert-System, 2komponentní vložka z měkké pěny. Vložka vhodná také pro HAZET-Assistent

E 125 1/2



HiPer
HIGH PERFORMANCE
THE ORIGINAL
MADE IN GERMANY

HAZET
SMART **case**

1/3				
-----	--	--	--	--



900 Z • • 1/2

10 • 11 • 12 • 13 • 14
15 • 16 • 17 • 18 • 19
20 • 21 • 22 • 23 • 24
26 • 27 • 28 • 30 • 32

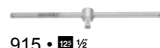

915 • 1/2



916 HP • 1/2



917-5 • 1/2 • 1/2



917-5 • 1/2 • 1/2

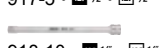

918-10 • 1/2 • 1/2



920 • 1/2 • 1/2

HAZET No.	d x š x v mm		EAN-No. 4000896+	€
900 Z	355x235x65	25	045440	362,40

900 AZ Sada nástrčných klíčů

Made in Germany

- S nástrčnými hlavici s dvojitým 6hranem
- Americké rozměry
- SmartCase (1/3) 165-L
- Safety-Insert-System, 2komponentní vložka z měkké pěny. Vložka vhodná také pro HAZET-Assistent

E 125 1/2

HiPer
HIGH PERFORMANCE
THE ORIGINAL
MADE IN GERMANY

HAZET
SMART **case**

1/3				
-----	--	--	--	--



900 AZ • • 1/2

3/8 • 7/16 • 1/2 • 9/16 • 19/32
5/8 • 11/16 • 3/4 • 25/32 • 13/16
7/8 • 15/16 • 31/32 • 1 • 1 1/16
1 1/8 • 1 3/16 • 1 1/4

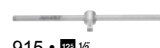

915 • 1/2



916 HP • 1/2

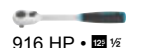

917-5 • 1/2 • 1/2



918-10 • 1/2 • 1/2

HAZET No.	d x š x v mm		EAN-No. 4000896+	€
900 A Z	355x235x65	23	043569	359,-

932 Sada nástrčných klíčů (6hran)

Made in Germany

- SmartCase (1/3) 165-L
- Safety-Insert-System, 2komponentní vložka z měkké pěny. Vložka vhodná také pro HAZET-Assistent

E 125 1/2



HiPer
HIGH PERFORMANCE
THE ORIGINAL
MADE IN GERMANY

HAZET
SMART **case**

1/3				
-----	--	--	--	--



900 • • 1/2

10 • 11 • 12 • 13 • 14
15 • 16 • 17 • 18 • 19
21 • 22 • 24 • 27

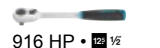

916 HP • 1/2



917-5 • 1/2 • 1/2

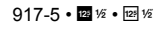

918-10 • 1/2 • 1/2

HAZET No.	d x š x v mm		EAN-No. 4000896+	€
932/18	355x235x65	18	168378	273,20



Ruční nářadí

12⁵ 1/2 Program nástrčných klíčů



900 HL Svorkovnice

- Jednoduchá montáž: 2 otvory např. pro upevnění na zeď
- Velikost svorek přizpůsobená velikosti pohonu
- Přehledné díky pohotovému připeřazení
- Z kovu
- Prázdná, se 16 přídržnými svorkami k osazení nástavci pro nástrčný klíč 900

12⁵ 1/2



HAZET No.	l mm	EAN-No. 4000896+	€
900 HL	430	043842	9,35

916 Přepínací ráčna · jemně ozubená

- **Made in Germany**
- Extrémně větší výkon u ráčen se srovnatelnými rozměry

12⁵ 1/2

- Aretační funkce páčky nabízí ochranu proti nechtěnému přepnutí
- Prodloužení životnosti použitím nejmodernějších maziv v ráčnovém mechanismu
- Úzké výrobní tolerance zaručují ochranu před vnikající nečistotou
- Interní standardy kvality HAZET zaručují zatížitelnost dalece nad normu
- Hodnotné, snadné čištění, odolné vůči korozi
- V rukojeti integrovaný prvek pro zavěšení
- VPA ověřený, statický uťahovací moment dle DIN 3122: 1000 Nm
- Počet zubů: 90
- Úhel ovládání: 4°
- S kuličkovou pojistkou
- 2komponentní rukojeť HAZET
- Povrch: chromováno
- DIN 3122, ISO 3315



HiPer
HIGH PERFORMANCE
THE ORIGINAL
MADE IN GERMANY

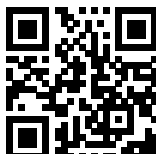

YouTube Clip

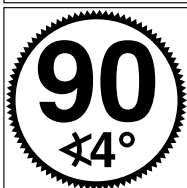

HAZET No.	l mm	EAN-No. 4000896+	€
916 HP	275	213894	70,-

916 Přepínací ráčna

- **Made in Germany**
- Počet zubů: 32
- Úhel ovládání: 11,25°
- S kuličkovou pojistkou
- 2komponentní rukojeť HAZET
- Povrch: chromováno, leštěno
- DIN 3122, ISO 3315

12⁵ 1/2



360°



916 Přepínací ráčna

12⁵ 1/2

HAZET No.	l mm	EAN-No. 4000896+	€
916 SP	275	046317	61,50

916 Přepínací ráčna s kloubem

- **Made in Germany**
- Ráčnová hlava otočná o >180°

12⁵ 1/2

- Krátké provedení
- Počet zubů: 32
- Úhel ovládání: 11,25°
- S kloubem – pro použití na těžko přístupných místech a pro obejití rušivých hran
- S kuličkovou pojistkou
- 2komponentní rukojeť HAZET
- Povrch: chromováno, leštěno
- DIN 3122, ISO 3315



HAZET No.	l mm	EAN-No. 4000896+	€
916 GK	270	046201	85,65

916 Přepínací ráčna · dlouhá · s kloubem

- **Made in Germany**
- Ráčnová hlava otočná o >180°

12⁵ 1/2

- Dlouhé provedení
- Počet zubů: 32
- Úhel ovládání: 11,25°
- S kloubem – pro použití na těžko přístupných místech a pro obejití rušivých hran
- S kuličkovou pojistkou
- 2komponentní rukojeť HAZET
- Povrch: chromováno, leštěno
- DIN 3122, ISO 3315



HAZET No.	l mm	b mm	EAN-No. 4000896+	€
916 GL	511	40	202485	95,25

916 Přepínací ráčna · krátká

- **Made in Germany**
- Krátké provedení jen 199 mm s kompaktní konstrukční velikostí 9³⁶ ráčny

12⁵ 1/2

- Maximální uťahovací moment: 300 Nm
- Krátké provedení
- Počet zubů: 30
- Úhel ovládání: 12°
- S kuličkovou pojistkou
- 2komponentní rukojeť HAZET
- Povrch: chromováno, leštěno
- DIN 3122, ISO 3315

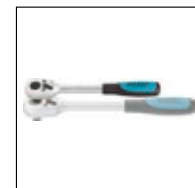

HAZET No.	l mm	EAN-No. 4000896+	€
916 K	199	155736	52,60



916 Přepínací ráčna · jemně ozubená · dlouhá

Made in Germany

12,5 1/2

• Extrémně větší výkon u ráčen se srovnatelnými rozměry

- Aretační funkce páčky nabízí ochranu proti nechtěnému přepnutí
- Prodloužení životnosti použitím nejmodernějších maziv v ráčnovém mechanismu
- Úzké výrobní tolerance zaručují ochranu před vnikající nečistotou
- Interní standardy kvality HAZET zaručují zatížitelnost dalece nad normu
- Hodnotné, snadné čištění, odolné vůči korozi
- V rukojeti integrovaný prvek pro zavěšení
- Dlouhé provedení
- Počet zubů: 90
- Úhel ovládání: 4°
- S kuličkovou pojistkou
- 2komponentní rukojeť HAZET
- Povrch: chromováno
- podobné DIN 3122, Similar to ISO 3315



YouTube Clip



HiPer
HIGH PERFORMANCE
THE ORIGINAL
MADE IN GERMANY



HAZET No.	l mm	EAN-No. 4000896+	€
916 HP L	415	219209	98,90

916 Přepínací ráčna · jemně ozubená · výsuvná

Made in Germany

12,5 1/2

• Extrémně větší výkon u ráčen se srovnatelnými rozměry

- Aretační funkce páčky nabízí ochranu proti nechtěnému přepnutí
- Prodloužení životnosti použitím nejmodernějších maziv v ráčnovém mechanismu
- Úzké výrobní tolerance zaručují ochranu před vnikající nečistotou
- Interní standardy kvality HAZET zaručují zatížitelnost dalece nad normu
- Hodnotné, snadné čištění, odolné vůči korozi
- V rukojeti integrovaný prvek pro zavěšení
- **Extra dlouhé provedení**
- Počet zubů: 90
- Úhel ovládání: 4°
- S kuličkovou pojistkou
- 2komponentní rukojeť HAZET
- Povrch: chromováno
- podobné DIN 3122, Similar to ISO 3315
- Plynule výsuvná ze 414 na 614 mm (bez předfixovaných aretačních bodů)
- Snadná fixace prostřednictvím neklouzajících upínací matice
- Rukojeť zajištěná proti přetočení zaručuje optimální přenos síly bez klouzání



916 Přepínací ráčna · jemně ozubená · výsuvná

12,5 1/2



reddot winner 2020

HiPer
HIGH PERFORMANCE
THE ORIGINAL
MADE IN GERMANY



HAZET No.	l ₁ mm	l ₂ mm	EAN-No. 4000896+	€
916 HP Lg	414	614	233076	130,-

Opatření? – Žádný problém!

- Nářadí HAZET je vyrobeno v **nejvyšší kvalitě**. Při dlouhém, intenzivním namáhání dochází i u vysoce kvalitních nástrojů k určitému opotřebením.
- Proto nabízíme pro mnoho našich nástrojů náhradní díly a sady náhradních dílů.

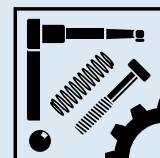

Nezapomeňte na náš obchod s náhradními díly
www.hazet.de/ersatzteil-shop

Úspora nákladů – udržitelnost – šetří zdroje!
Abyste se mohli ze svého nářadí HAZET dlouho těšit

916 Sada náhradních dílů

Made in Germany

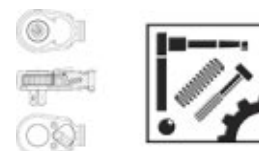

HAZET No.	EAN-No. 4000896+	€
<ul style="list-style-type: none"> • Sada náhradních dílů 12,5 = 1/2" ■, obsah sady: fixační prvek · tlačná pružina · kulička · pružinové pouzdro · přepínací páka · krycí kotouč · pojistný kroužek · ráčnové kolo · tuk · montážní nářadí Pro přepínací ráčnu 916 HP · 916 HP L · 916 HP Lg 	218981	38,45
<ul style="list-style-type: none"> • Sada náhradních dílů kolečka ráčny 12,5 = 1/2" ■, obsah sady: ovládací páka · 2 šrouby · kulička · tlačná pružina · kolečko ráčny se spouštěcím tlačítkem a fixační prvek Pro přepínací ráčnu HAZET 916 S a k přestavení přepínací ráčny HAZET 916 SP · 916 GK · 916 L · 916 ST 	046300	36,80
<ul style="list-style-type: none"> • Sada náhradních dílů ovládací páky 12,5 = 1/2" ■, obsah sady: ovládací páka · 2 šrouby · kulička a tlačná pružina a fixační prvek Pro přepínací ráčnu HAZET 916 S · 916 SP · 916 GK · 916 Lg · 916 L · 916 GL · 916 ST 	144624	10,75
<ul style="list-style-type: none"> • Sada náhradních dílů kolečka ráčny 12,5 = 1/2" ■, obsah sady: ovládací páka · šrouby · kulička · tlačná pružina · kolečko ráčny a fixační prvek Pro přepínací ráčnu HAZET 916 SP · 916 GK · 916 Lg · 916 L · 916 GL · 916 ST 	046348	24,20
<ul style="list-style-type: none"> • Sada náhradních dílů kolečka ráčny 12,5 = 1/2" ■, obsah sady: ovládací páka · šrouby · kulička · tlačná pružina · kolečko ráčny a fixační prvek Pro přepínací ráčnu HAZET 916 K 	155743	20,85



Ruční nářadí

12⁵ 1/2 Program nástrčných klíčů



914 Trhák s kloubem

Made in Germany

12⁵ 1/2

- S kloubem – pro použití na těžko přístupných místech a pro obejití rušivých hran
- S kuličkovou pojistkou
- 2komponentní rukojeť HAZET
- Povrch: chromováno
- DIN 3122, ISO 3315



HAZET No.	l mm	FAN-No. 4000896+	€
914-15	396	046027	57,20
914-18	472	046041	62,90

915 Příčná rukojeť

Made in Germany

12⁵ 1/2

- S kuličkovou pojistkou
- Povrch: chromováno, leštěno
- DIN 3122, ISO 3315



HAZET No.	l mm	FAN-No. 4000896+	€
915	298	046072	23,-

900 Nástrčná hlavice · šestihran

Made in Germany

12⁵ 1/2

- S rýhováním
- Povrch: chromováno, leštěno
- DIN 3124, ISO 2725-1

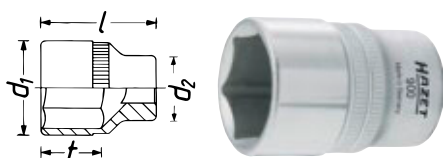

* = Mimo řady DIN

HAZET No.	l mm	d ₁ mm	d ₂ mm	t mm	FAN-No. 4000896+	€
900- 8	38	12	22	7,8	042968	7,60
900- 9 *	38	13,5	22	8,8	042975	7,60
900-10	38	14,9	22	10,8	042715	6,45
900-11	38	16,4	22	10,8	042722	7,60
900-12	38	17,5	22	11,3	042739	7,60
900-13	38	18,8	22	11,3	042746	6,45
900-14	38	20,3	22,5	11,8	042753	7,85
900-15	38	21,5	23,2	11,8	042760	7,85
900-16	38	22,7	23,6	12,2	042777	7,85
900-17	38	24,1	22	12,7	042784	8,30
900-18	38	25,4	22,4	14,2	042791	9,25
900-19	38	26,6	23	14,2	042807	8,45
900-20	38	27,8	24	14,2	042821	9,85
900-21	38	29	25	14,1	042838	9,85
900-22	41,5	30,4	26	17,6	042845	9,85
900-23	41,5	31,4	26	17,6	042869	11,15
900-24	44	32,6	26	18,2	042876	10,45
900-25	44	33,9	26	17,9	042883	11,15
900-26	44	35,1	24	17,8	042890	11,75
900-27	46	36,2	25	19,7	042906	13,95
900-28	47	37,5	26	20,6	042913	13,95
900-29 *	50	38,7	27	23,4	042920	13,95
900-30	50	40,1	28	23,3	042937	13,95
900-32	50	42,3	28	23	042944	13,95
900-34	52	46	28	23,3	042951	18,30
900-36	57	49	28	25,6	192519	19,95

900 LG Nástrčná hlavice · šestihran

Made in Germany

12⁵ 1/2

- Dlouhé provedení
- S rýhováním
- Povrch: chromováno, leštěno
- DIN 3124, ISO 2725-1

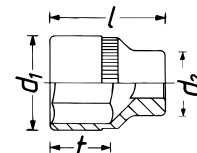
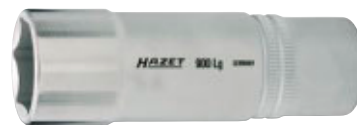

HAZET No.	l mm	d ₁ mm	d ₂ mm	t mm	FAN-No. 4000896+	€
900 Lg-10	85	14,9	22	10	053438	17,50
900 Lg-12	85	17,5	22	12,3	043873	17,50
900 Lg-13	85	18,8	22	13,3	043880	17,50
900 Lg-14	85	19,9	22,5	14,2	043897	18,15
900 Lg-15	85	21,5	23,2	15,2	043903	19,10
900 Lg-16	85	22,7	23,6	16	043910	19,45
900 Lg-17	85	24,1	23,6	19	043927	19,45
900 Lg-18	85	24,6	23,6	19	043934	19,45
900 Lg-19	85	28,5	26	19	043941	19,45
900 Lg-21	85	28,6	24,5	19	043965	21,75
900 Lg-22	85	30,4	25	22	043972	22,05
900 Lg-24	85	32,6	27,5	25	043989	22,40
900 Lg-27	85	36,3	30	28	044009	25,10
900 Lg-30	85	40,1	33	31	044016	26,80
900 Lg-32	85	42,5	35	34,2	049660	27,15

900 Z Nástrčná hlavice · dvojitý šestihran

Made in Germany

12⁵ 1/2

- S rýhováním
- Povrch: chromováno, leštěno
- DIN 3124, ISO 2725-1

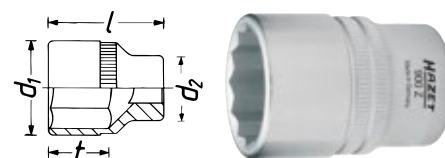

* = Mimo řady DIN

HAZET No.	l mm	d ₁ mm	d ₂ mm	t mm	FAN-No. 4000896+	€
900 Z- 8	38	12	22	7,5	045686	7,60
900 Z- 9 *	38	13,5	22	8,5	045693	7,60
900 Z-10	38	14,9	22	10,5	045457	6,45
900 Z-11	38	16,4	22	10,5	045464	7,60
900 Z-12	38	17,5	22	11	045471	7,60
900 Z-13	38	18,8	22	11	045488	6,45
900 Z-14	38	20,3	22,5	11,5	045495	7,85
900 Z-15	38	21,5	23,2	11,5	045501	7,85
900 Z-16	38	22,7	23,6	12,5	045518	7,85
900 Z-17	38	24,1	22	12,5	045525	8,45
900 Z-18	38	25,4	22,4	14	045532	9,25
900 Z-19	38	26,6	23	14	045549	8,45
900 Z-20	38	27,8	24	14	045556	9,85
900 Z-21	38	29	25	14	045563	9,85
900 Z-22	41,5	30,4	25	17,5	045570	9,85
900 Z-23	41,5	31,4	26	17,5	045587	11,15
900 Z-24	44	32,6	26	20	045594	10,45
900 Z-25 *	44	33,9	26,5	20	045600	11,15
900 Z-26 *	44	35,1	24	20	045617	11,75
900 Z-27	46	36,2	25	21	045624	13,95
900 Z-28 *	47	37,5	26	22	045631	13,95
900 Z-30	50	40,1	28	25	045655	13,95
900 Z-32 *	50	42,3	28	24	045662	13,95
900 Z-33 *	50	43,6	28	24	045679	14,65
900 Z-34	52	46	28	23,3	144792	18,30
900 Z-36	57	49	28	25,6	192502	19,95



900 AZ Nástrčná hlavice · dvojitý šestihran

Made in Germany

- Americké rozměry
- S rýhováním
- Povrch: chromováno, leštěno
- DIN 3124, ISO 2725-1

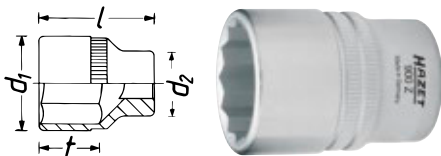

12⁵ 1/2

HAZET No.	l mm	d ₁ mm	d ₂ mm	f mm	EAN-No. 4000896+	€
900 AZ-3/8	38	14,5	22	10,5	043699	7,60
900 AZ-7/16	38	16,4	22	10,5	043729	7,60
900 AZ-1/2	38	18,3	22	11	043620	7,60
900 AZ-9/16	38	20,5	22,5	11,5	043743	7,85
900 AZ-19/32	38	21,5	23,2	11,5	043668	7,85
900 AZ-5/8	38	22,7	23,6	12,5	043712	7,85
900 AZ-11/16	38	24,6	22	12,5	043637	9,50
900 AZ-3/4	38	26,8	23	14	043682	9,50
900 AZ-25/32	38	27,8	24	14	043675	9,85
900 AZ-13/16	38	28,6	25	14	043644	9,85
900 AZ-7/8	41,5	30,4	26	17,5	043736	9,85
900 AZ-15/16	44	32,6	26	20	043651	11,20
900 AZ-31/32	44	33,4	24,6	20	043705	11,20
900 AZ-1	44	34,6	24,8	20	043576	11,20
900 AZ-1.1/16	46	36,3	25	21	043583	13,95
900 AZ-1.1/8	47	38,2	26,5	22	043606	13,95
900 AZ-1.3/16	50	40,1	28	25	043613	13,95
900 AZ-1.1/4	50	42,3	28	24	043590	13,95

900 TZ Nástrčná hlavice · dvojitý šestihran

Made in Germany

- Dlouhé provedení
- S rýhováním
- Povrch: chromováno, leštěno
- DIN 3124, ISO 2725-1



12⁵ 1/2

+ = S přídržnou gumovou vložkou pro zapalovací svíčky

HAZET No.	l mm	d ₁ mm	d ₂ mm	f mm	EAN-No. 4000896+	€
900 TZ-10	85	14,9	22	10	053452	17,50
900 TZ-11	85	16,4	22	11,5	053445	17,50
900 TZ-12	85	17,5	22	12,3	045242	17,50
900 TZ-13	85	18,8	22	13,3	045259	17,50
900 TZ-14	85	19,9	22,5	15,2	045266	18,15
900 TZ-15	85	21,5	23,2	15,2	045273	19,10
900 TZ-16	85	22,7	23,6	16	045280	19,45
900 TZ-17	85	24,1	23,6	19	045297	19,45
900 TZ-18	85	24,6	23,6	19	045310	19,45
900 TZ-19	85	26,8	26	19	045334	19,45
900 TZ-20.8-19/16 +	85	28,5	24,5	19	045341	23,-
900 TZ-21	85	28,6	24,5	19	045358	21,75
900 TZ-22	85	30,4	25	22	045365	22,05
900 TZ-24	85	32,6	27,5	25	045389	22,40
900 TZ-27	85	36,3	30	28	045419	25,10
900 TZ-30	85	40,1	33	31	045426	26,80

960 MGT Magnetická vložka pro nástrčné klíče

• Univerzálně použitelné v metrických nástrčných hlavících s 6hranem a dvojitým 6hranem s 10 až 19 mm

- Plastové vložky s integrovaným magnetem
- Vysoká přídržná síla
- Opakované použití
- 10dílná sada, pro metrické nástrčné klíče s 10 · 11 · 12 · 13 · 14 · 15 · 16 · 17 · 18 · 19 mm
- DIN 3124, ISO 2725-1

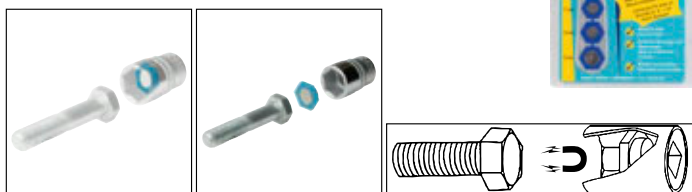

HAZET No.	EAN-No. 4000896+	€
960 MgT	097661	23,80

900 MGT Nástrčná hlavice na zapalovací svíčky

Made in Germany

- Pro výměnu zapalovacích svíček
- Permanentní magnet
- Americké rozměry
- Povrch: chromováno, leštěno
- DIN 3124, ISO 2725-1

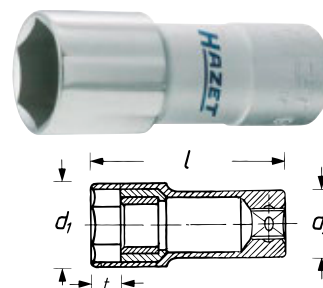

12⁵ 1/2

HAZET No.	s mm	s" "	l mm	d ₁ mm	d ₂ mm	f mm	EAN-No. 4000896+	€
900 Mg T	20,8	13/16	68	27,4	23,5	9	044023	20,15
900 A Mg T	16	5/8	71	22,5	22,5	8,5	043491	20,15

900 KF Nástrčná hlavice na zapalovací svíčky

Made in Germany

- Pro výměnu zapalovacích svíček
- Korunková pružina jako přídržný mechanismus
- Korunková pružina zmenšuje riziko poškození izolátoru
- Americké rozměry
- Povrch: chromováno, leštěno
- DIN 3124, ISO 2725-1

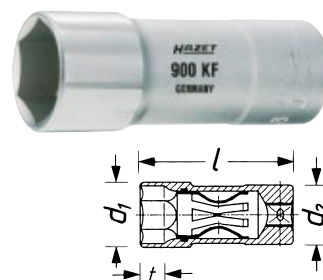

12⁵ 1/2

HAZET No.	s mm	s" "	l mm	d ₁ mm	d ₂ mm	f mm	EAN-No. 4000896+	€
900 KF	20,8	13/16	71	27,4	25	10	043859	15,90
900 A KF	16	5/8	71	22,5	22,5	10	043408	15,90

Informace – korunková pružina

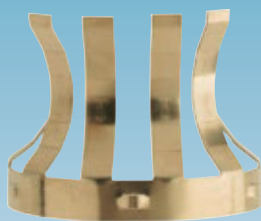
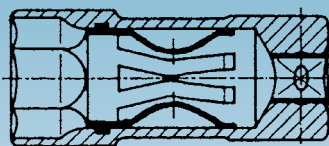

- Korozivzdorná a odolná proti teplu
- Maximální volnost keramického izolátoru
- 6 pružících prvků – bezpečná opora zapalovacích svíček
- Tlumení příčných pohybů



Ruční nářadí

125 1/2 Program nástrčných klíčů



880 KF Korunková pružina

Made in Germany
• Americké rozměry



HAZET No.	EAN-No. 4000896+	€
• Korunková pružina pro klíč na zapalovací svíčky HAZET 880 KF · 900 KF · 4767 KF		
880 KF-01	050123	2,50
• Korunková pružina pro klíč na zapalovací svíčky HAZET 880 A KF · 900 A KF · 4766 · 4766-1 · 4767 A KF		
880 A KF-01	050130	2,50

848 Z Očkový klíč · dvojitý 6hran · otevřený

Made in Germany
• Pentagramový klíč
• Pro převlečné matice a trubková šroubení
• Čtyřhranné uchycení

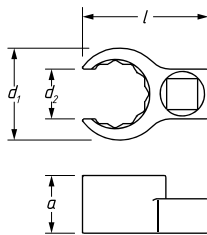

HAZET No.	l mm	d1 mm	d2 mm	a mm	mm	EAN-No. 4000896+	€
848 Z-17	40,9	27,5	14,5	18	□ 10 = 3/8"	079094	54,75
848 Z-18	41,7	29	15	19	□ 10 = 3/8"	079100	54,75
848 Z-19	41,9	30	16	19	□ 10 = 3/8"	079117	53,75
848 Z-21	46	32	16,5	19	□ 10 = 3/8"	079124	55,70
848 Z-22	46,5	33,5	17,5	19,5	□ 10 = 3/8"	079131	55,70
848 Z-24	50	36,5	18,5	20	□ 10 = 3/8"	079148	55,70
848 Z-27	53,7	40,5	20,5	22	□ 10 = 3/8"	079162	59,95
848 Z-30	62,4	46,5	25	23	□ 12,5 = 1/2"	079179	69,70
848 Z-32	63,7	48,5	24,5	23	□ 12,5 = 1/2"	079186	72,45
848 Z-36	67,1	52,5	27,5	24,5	□ 12,5 = 1/2"	079193	74,90
848 Z-41	74,1	58,5	31	24,5	□ 12,5 = 1/2"	079216	81,75
848 Z-46	77,7	64,5	35,5	26,5	□ 12,5 = 1/2"	079223	92,50

900 E Nástrčná hlavice TORX®

Made in Germany
• S rýhováním
• Povrch: chromováno, leštěno
• DIN 3124, ISO 2725-1

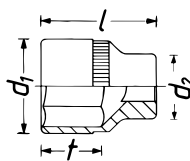

HAZET No.	l mm	d1 mm	d2 mm	mm	EAN-No. 4000896+	€
900-E 10	38	13,3	22	9,42	042982	12,50
900-E 11	38	14	22	10,08	043002	13,35
900-E 12	38	14,9	22	11,17	043019	13,35
900-E 14	38	16,7	22	12,90	043033	13,50
900-E 16	38	19	22	14,76	043057	13,50
900-E 18	38	21	27	16,70	043071	13,95
900-E 20	38	23,5	27	18,49	043095	13,95
900-E 24	41,2	28,5	27	22,16	043118	15,75

900 Sada nástrčných hlavice TORX®

Made in Germany
• S rýhováním
• Safety-Insert-System, 2komponentní vložka z měkké pěny.
Vložka vhodná také pro HAZET-Assistent
• Povrch: chromováno, leštěno
• DIN 3124, ISO 2725-1

125 1/2



900 E • 125 1/2
E 10 • E 12 • E 14 • E 16 • E 18



HAZET No.	d x š mm	mm	EAN-No. 4000896+	€
900-E/5	172x50	5	129331	67,80

980 Nástrčná hlavice

Made in Germany
• Povrch: chromováno
• DIN 3124, ISO 2725-1

125 1/2

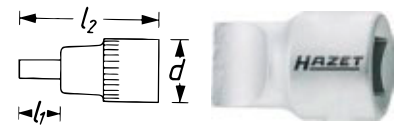

HAZET No.	l1 mm	l2 mm	d mm	EAN-No. 4000896+	€
980-2x13	21	38	22	046737	9,70
980-3x19	20	38	23,7	046744	11,40

985 Nástrčná hlavice

Made in Germany
• Extra krátké provedení
• S rýhováním
• DIN 7422, DIN 3124, ISO 2725-1

125 1/2

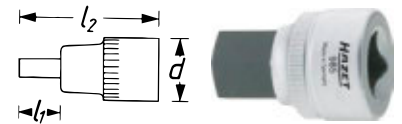

* = Mimo řady DIN

HAZET No.	s mm	l1 mm	l2 mm	d mm	EAN-No. 4000896+	€
985- 5 *	5	5	38	23	046836	13,75
985- 6	6	6	38	23	046843	13,85
985- 8	8	8	38	23	046850	14,05
985-10	10	10	40	25	046775	14,55
985-12	12	12	40	25	046782	14,55
985-14	14	14	40	25	046799	15,10
985-17 *	17	17	42	28	046805	16,50
985-19 *	19	19	42	28	046812	17,30

985 Sada nástrčných klíčů

Made in Germany
• Extra krátké provedení
• S rýhováním
• Kovová schránka (modrá HAZET)
• 2komponentní měkká pěnová vložka
• DIN 7422

125 1/2



985 • 125 1/2
5 • 6 • 8 • 10
12 • 14 • 17 • 19

916 HP • 125 1/2

917-5 • 125 1/2 • 125 1/2

915 • 125 1/2

918-10 • 125 1/2 • 125 1/2

HAZET No.	mm	EAN-No. 4000896+	€
985	12	046768	242,50



Povrchová úprava TiN

TiN

Proč povrchová úprava TiN (nitrid titanu)?

- Speciální metoda velmi tvrdé povrchové úpravy TiN dosahuje extrémně vysoké přilnavosti a otěruvzdornosti vrstvy
- Optimálně vhodné při dlouhodobém zatížení, např. sériovém šroubování v průmyslu a dílnách
- Vyšší ochrana proti opotřebení zajišťuje delší životnost
- Perfektní přesnost díky optimální tloušťce vrstvy
- Vyšší utahovací moment
- Optimální ochrana proti korozi

Nástrčné hlavice s TiN úpravou

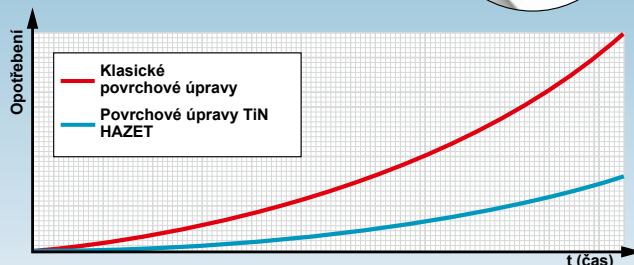
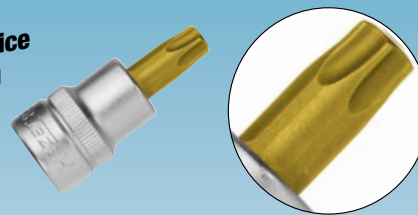

986 Nástrčná hlavice

Made in Germany

- Krátké provedení
- S rýhováním
- Povrch:
- DIN 7422, DIN 3124, ISO 2725-1

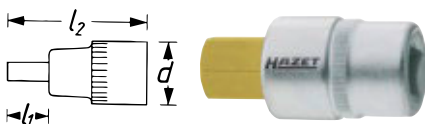

* = Mimo řady DIN

HAZET No.	S mm	l ₁ mm	l ₂ mm	d mm	EAN-No. 4000896+	€
986- 4 *	4	22	60	23	046928	13,70
986- 5 *	5	22	60	23	046935	13,70
986- 6	6	22	60	23	046942	13,70
986- 7	7	22	60	23	046959	13,70
986- 8	8	22	60	23	046973	13,80
986- 9	9	22	60	23	146734	13,80
986-10	10	22	60	23	046874	13,80
986-12	12	22	60	24,6	046881	16,05
986-14	14	22	60	24,6	046898	17,30
986-17 *	17	20	60	28,5	046904	19,40
986-19 *	19	20	60	31,5	046911	20,50
986-22 *	22	20,5	60	28	082865	22,90

HAZET No.	S mm	l ₁ mm	l ₂ mm	d mm	EAN-No. 4000896+	€
2584	6	32	70	23	017041	19,90

986 L Nástrčná hlavice

Made in Germany

- Dlouhé provedení
- S rýhováním
- Povrch:
- DIN 7422, DIN 3124, ISO 2725-1

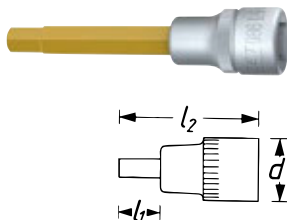

HAZET No.	S mm	l ₁ mm	l ₂ mm	d mm	EAN-No. 4000896+	€
986 L- 4	4	62	100	23	232635	13,95
986 L- 5	5	62	100	23	232628	13,95
986 L- 6	6	62	100	23	232611	13,95
986 L- 7	7	62	100	23	232604	13,95
986 L- 8	8	62	100	23	232598	14,05
986 L- 9	9	62	100	23	232581	14,05
986 L-10	10	62	100	23	232574	14,05
986 L-11	11	62	100	23	232567	14,95
986 L-12	12	62	100	23	232550	16,15
986 L-14	14	62	100	23	232543	17,40

986 SL Nástrčná hlavice

Made in Germany

- Extra dlouhé provedení
- S rýhováním
- Povrch:
- DIN 7422, DIN 3124, ISO 2725-1

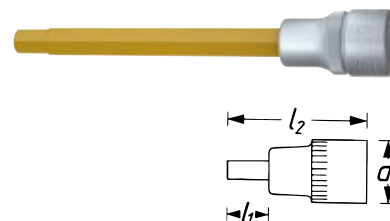

HAZET No.	S mm	l ₁ mm	l ₂ mm	d mm	EAN-No. 4000896+	€
986 SL- 4	4	102	140	23	232291	14,25
986 SL- 5	5	102	140	23	232376	14,25
986 SL- 6	6	102	140	23	232369	14,25
986 SL- 7	7	102	140	23	232352	14,25
986 SL- 8	8	102	140	23	232345	14,35
986 SL- 9	9	102	140	23	232338	14,35
986 SL-10	10	102	140	23	232321	14,35
986 SL-11	11	102	140	23	232314	15,25
986 SL-12	12	102	140	23	232536	16,55
986 SL-14	14	102	140	23	232307	17,80

986 A Nástrčná hlavice

Made in Germany

- Krátké provedení
- Americké rozměry
- S rýhováním
- Povrch:
- DIN 3124, ISO 2725-1

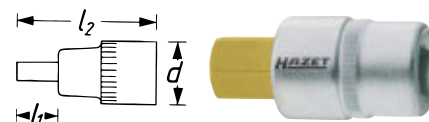

HAZET No.	l ₁ mm	l ₂ mm	d mm	EAN-No. 4000896+	€
986 A-5/32	14	52	23	047048	14,20
986 A-3/16	14	52	23	047017	14,20
986 A-7/32	14	52	23	047062	14,20
986 A-1/4	14	52	23	047000	14,20
986 A-5/16	14	52	23	047031	14,30
986 A-3/8	14	52	23	047024	14,30
986 A-7/16	14	52	23	047055	15,20
986 A-1/2	14	52	23	046997	17,90

HAZET No.	S mm	l ₁ mm	l ₂ mm	EAN-No. 4000896+	€
2584-1	6	210	248	017058	24,40



Ruční nářadí

125 1/2 Program nástrčných klíčů



986 KK Nástrčná hlavice

Made in Germany

- Zejména pro práci ve stísněných podmínkách (např. v motorovém prostoru)
- Dlouhé provedení
- S kulovou hlavou
- S rýhováním
- Povrch:
- DIN 3124, ISO 2725-1

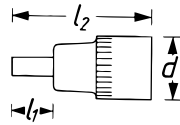

125 1/2

HAZET No.	S mm	l ₁ mm	l ₂ mm	d mm	EAN-No. 4000896+	€
986 KK- 5	5	102	140	23	052103	15,20
986 KK- 6	6	102	140	23	050666	15,20
986 KK- 7	7	102	140	23	052110	15,80
986 KK- 8	8	102	140	23	052127	15,80
986 KK-10	10	102	140	23	052134	18,20
986 KK-12	12	102	140	24,6	052141	21,-

HAZET No.	S mm	l ₁ mm	l ₂ mm	d mm	EAN-No. 4000896+	€
2527-8	8	200	238	23	016310	27,45

986 Sada nástrčných hlavice

Made in Germany

- Krátké provedení
- S rýhováním
- SmartCase (1/9) 165-S
- Safety-Insert-System, 2komponentní vložka z měkké pěny. Vložka vhodná také pro HAZET-Assistent
- Povrch:
- DIN 7422



360°

986 • •
 5 • 6 • 7 • 8 • 10
 12 • 14 • 17 • 19

HAZET No.	d x š x v mm		EAN-No. 4000896+	€
986/9	185x153x52	9	051564	171,-

Made in Germany

- Krátké provedení
- S rýhováním
- SmartCase (1/9) 165-S
- Safety-Insert-System, 2komponentní vložka z měkké pěny. Vložka vhodná také pro HAZET-Assistent
- Povrch:
- DIN 7422



986 • •
 5 • 6 • 7 • 8 • 9
 10 • 12 • 14 • 17

HAZET No.	d x š x v mm		EAN-No. 4000896+	€
986/9 N	185x153x52	9	193530	169,40

986 Sada nástrčných hlavice

Made in Germany

- S kulovou hlavou
- S rýhováním
- SmartCase (1/3) 165-L
- Safety-Insert-System, 2komponentní vložka z měkké pěny. Vložka vhodná také pro HAZET-Assistent
- Povrch:
- DIN 7422



986 • •
 5 • 6 • 7 • 8 • 10 • 12 • 14 • 17 • 19

986 KK • •
 6 • 7 • 8 • 10

HAZET No.	d x š x v mm		EAN-No. 4000896+	€
986/13	355x235x65	13	168330	186,50

Made in Germany

- Krátké provedení
- S rýhováním
- Safety-Insert-System, 2komponentní vložka z měkké pěny. Vložka vhodná také pro HAZET-Assistent
- Povrch:



986 • •
 5 • 6 • 7 • 8 • 10

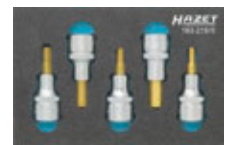

HAZET No.	d x š mm		EAN-No. 4000896+	€
163-215/5	172x114	5	168217	59,60

Made in Germany

- S kulovou hlavou
- S rýhováním
- Safety-Insert-System, 2komponentní vložka z měkké pěny. Vložka vhodná také pro HAZET-Assistent
- Povrch:

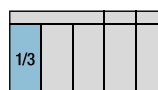

986 • •
 5 • 6 • 7 • 8 • 10 • 12 • 14 • 17 • 19

986 KK • •
 6 • 7 • 8 • 10

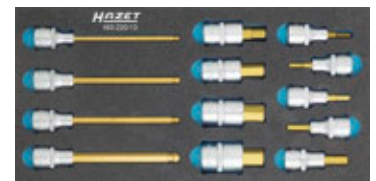

HAZET No.	d x š mm		EAN-No. 4000896+	€
163-220/13	342x172	13	168286	159,30



990 Nástrčná hlavice

Made in Germany

- Krátké provedení
- S rýhováním
- Povrch:
- DIN 3124, ISO 2725-1

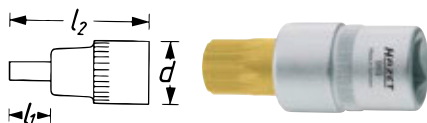

HAZET No.	l_1 mm	l_2 mm	d mm	EAN-No. 4000896+	€
990- 5	14	52	23	047307	16,75
990- 6	14	52	23	047314	16,75
990- 8	15	53	23	047321	16,75
990-10	15	53	23	047253	18,35
990-12	17	55	23	047277	22,10
990-14	20	58	24,6	047284	24,45
990-16	22	60	24,6	047291	27,05
990-18	45	85	26	108916	28,60

990 LG Nástrčná hlavice

Made in Germany

- Dlouhé provedení
- S rýhováním
- Povrch:
- DIN 3124, ISO 2725-1

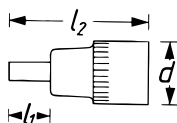

HAZET No.	l_1 mm	l_2 mm	d mm	EAN-No. 4000896+	€
990 Lg- 6	62	100	23	056248	18,25
990 Lg- 8	62	100	23	047352	19,15
990 Lg- 9	62	100	23	103140	19,85
990 Lg-10	62	100	23	047338	20,40
990 Lg-12	62	100	23	047345	24,70
990 Lg-14	62	100	23	065240	26,90

HAZET No.	EAN-No. 4000896+	€
2751	017508	30,40

990 SLG Nástrčná hlavice

Made in Germany

- Extra dlouhé provedení
- S rýhováním
- Povrch:
- DIN 3124, ISO 2725-1

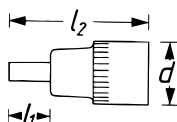

HAZET No.	l_1 mm	l_2 mm	d mm	EAN-No. 4000896+	€
990 S Lg-10	82	120	23	047369	26,60
990 S Lg-12	102	140	23	047376	29,-

990 Sada nástrčných hlavíc

Made in Germany

- S rýhováním
- SmartCase (1/3) 165-L
- Safety-Insert-System, 2komponentní vložka z měkké pěny.
- Vložka vhodná také pro HAZET-Assistent
- Povrch:



990 •
M 8 • M 10 • M 12
M 14 • M 16 • M 18



990 LG •
M 8 • M 14



990 SLG •
M 10 • M 12

HAZET No.	$d \times \text{š} \times v$ mm		EAN-No. 4000896+	€
990/10	355x235x65	10	168347	171,10

991 Nástrčná hlavice

Made in Germany

- Krátké provedení
- S rýhováním
- Povrch:
- DIN 3124, ISO 2725-1

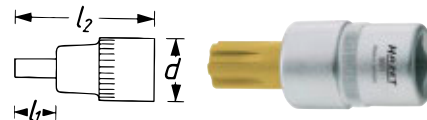

HAZET No.	l_1 mm	l_2 mm	d mm	EAN-No. 4000896+	€
991- 6	25	63	23	047451	17,60
991- 7	25	63	23	132799	17,60
991- 8	25	63	23	047468	17,60
991- 9	25	63	23	132812	19,-
991-10	25	63	23	047406	19,-
991-12	25	63	23	047413	23,05
991-14	25	63	24,6	047420	26,60

992 Nástrčná hlavice TORX®

Made in Germany

- Krátké provedení
- S rýhováním
- Povrch:
- DIN 3124, ISO 2725-1

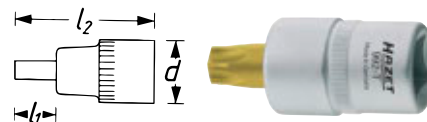

HAZET No.	l_1 mm	l_2 mm	d mm		EAN-No. 4000896+	€
992-T 20	17	55	23	3,86	047475	14,60
992-T 25	17	55	23	4,43	047482	14,60
992-T 27	17	55	23	4,99	047499	14,60
992-T 30	17	55	23	5,52	047505	14,60
992-T 40	17	55	23	6,65	047512	16,75
992-T 45	17	55	23	7,82	047529	16,75
992-T 50	17	55	23	8,83	047543	16,75
992-T 55	18	56	24,6	11,22	047574	20,95
992-T 60	18	56	24,6	13,25	047598	20,95



Ruční nářadí

125 1/2 Program nástrčných klíčů



992 Sada nástrčných hlavic TORX®

Made in Germany

- Krátké provedení
- S rýhováním
- SmartCase (1/9) 165-S
- Safety-Insert-System, 2komponentní vložka z měkké pěny. Vložka vhodná také pro HAZET-Assistent
- Povrch:

TIN E 125 1/2



1/9				
-----	--	--	--	--

992 • 1/2
 T 20 • T 25 • T 27
 T 30 • T 40 • T 45
 T 50 • T 55 • T 60

HAZET No.	d x š x v mm		EAN-No. 4000896+	€
992/9	185x153x52	9	051540	170,90

992 T Sada nástrčných hlavic TORX®

Made in Germany

- S rýhováním
- Safety-Insert-System, 2komponentní vložka z měkké pěny. Vložka vhodná také pro HAZET-Assistent
- Povrch:

TIN E 125 1/2

1/9				
-----	--	--	--	--

992 • 1/2
 T 20 • T 25 • T 27 • T 30 • T 40
 T 45 • T 50 • T 55 • T 60



HAZET No.	d x š mm		EAN-No. 4000896+	€
163-271/9	172x114	9	181056	150,-

992 H Nástrčná hlavice TORX®

Made in Germany

- Vyvrtaný otvor na čelní straně
- Krátké provedení
- S rýhováním
- Povrch:
- DIN 3124, ISO 2725-1

TIN 125 1/2

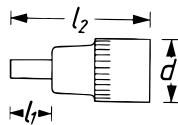

HAZET No.	l ₁ mm	l ₂ mm	d mm		EAN-No. 4000896+	€
992-T 30 H	17	55	23	5,52	050857	17,60
992-T 40 H	17	55	23	6,65	050864	19,70
992-T 45 H	17	55	23	7,82	050871	19,70
992-T 50 H	17	55	23	8,83	050888	19,70
992-T 55 H	18	56	23	11,22	050895	23,80

992 LG Nástrčná hlavice TORX®

Made in Germany

- Dlouhé provedení
- S rýhováním
- Povrch:
- DIN 3124, ISO 2725-1

TIN 125 1/2

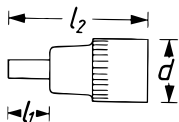

HAZET No.	l ₁ mm	l ₂ mm	d mm		EAN-No. 4000896+	€
992 Lg-T 50	62	100	23	8,83	103133	28,25
992 Lg-T 55	57	96	23,3	11,22	057337	28,50
992 Lg-T 60	45	83	23	13,25	100590	37,80
992 Lg-T 70	67	105	24,6	15,54	047611	41,25

992 SLG Nástrčná hlavice TORX®

Made in Germany

- Extra dlouhé provedení
- Povrch:
- DIN 3124, ISO 2725-1

TIN 125 1/2

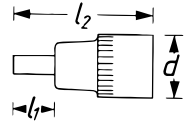

HAZET No.	l ₁ mm	l ₂ mm	d mm		EAN-No. 4000896+	€
992 S Lg-T 30	100	138	23	5,52	179183	14,65
992 S Lg-T 40	100	138	23	6,65	103539	29,70
992 S Lg-T 45	100	138	23	7,82	047635	31,35
992 S Lg-T 50	100	138	23	8,83	103454	32,55
992 S Lg-T 55	102	138	23	11,22	047642	33,30

163 Sada nástrčných hlavic

Made in Germany

- Safety-Insert-System, 2komponentní vložka z měkké pěny. Vložka vhodná také pro HAZET-Assistent
- Povrch:

TIN E 125 1/2

2/3				
-----	--	--	--	--

992 • 1/2
 T 20 • T 25 • T 27 • T 30 • T 40
 T 45 • T 50 • T 55 • T 60



HAZET No.	d x š mm		EAN-No. 4000896+	€
163-119/23	344x342	23	153510	303,20



HAZET No.	d x š mm		EAN-No. 4000896+	€
163-119/23	344x342	23	153510	303,20

Made in Germany

- Safety-Insert-System, 2komponentní vložka z měkké pěny. Vložka vhodná také pro HAZET-Assistent
- Povrch:

TIN E 125 1/2

2/3				
-----	--	--	--	--

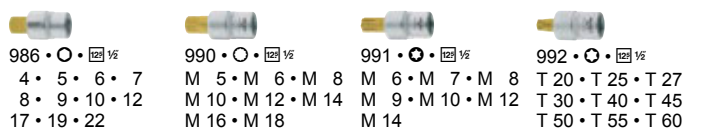

HAZET No.	d x š mm		EAN-No. 4000896+	€
163-407/35	344x342	35	199990	431,60



958 Adaptér

Made in Germany

- S kolíkovou pojistkou
- Povrch: chromováno
- DIN 3123, ISO 3316

12,5" 1/2"



HAZET No.	l mm	EAN-No. 4000896+	€
958-1	50	046676	18,20
958-2	36	046683	14,65

958 N Sada adaptérů

Made in Germany

- Po 1 adaptéru
- SmartCase (1/9) 165-S
- Safety-Insert-System, 2komponentní vložka z měkké pěny. Vložka vhodná také pro HAZET-Assistent

6.3 1/4" 10 3/8" 12,5 1/2" 20 3/4" 6.3 1/4" 10 3/8" 12,5 1/2" 20 3/4"



1/9				
-----	--	--	--	--

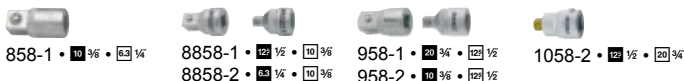

HAZET No.	d x š x v mm	6	EAN-No. 4000896+	€
958 N/6	185x153x52	6	168316	97,85

163 Sada adaptérů

Made in Germany

- Safety-Insert-System, 2komponentní vložka z měkké pěny. Vložka vhodná také pro HAZET-Assistent

6.3 1/4" 10 3/8" 12,5 1/2" 20 3/4" 6.3 1/4" 10 3/8" 12,5 1/2" 20 3/4"

1/9				
-----	--	--	--	--

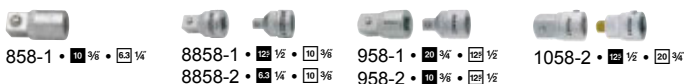

HAZET No.	d x š mm	6	EAN-No. 4000896+	€
163-217/6	172x114	6	168231	82,20

2250 Adaptér

Made in Germany

- Pro ruční manipulaci
- Uchycení vnitřní 4hran a vnitřní 6hran
- Přidrzná kulička pro bity
- Povrch: chromováno



2250 Adaptér

HAZET No.	l mm	EAN-No. 4000896+	€
2250-4	35	015504	17,40
2250-5	36	015511	17,50

920 Univerzální kloub

Made in Germany

- S kloubem – pro použití na těžko přístupných místech a pro obejítí rušivých hran
- S kuličkovou pojistkou
- Povrch: chromováno, leštěno
- DIN 3123, ISO 3316

12,5" 1/2" 12,5" 1/2"



HAZET No.	l mm	EAN-No. 4000896+	€
920	70	046515	31,70

917 Prodloužení

Made in Germany

- S kuličkovou pojistkou
- Povrch: chromováno, leštěná hlava
- DIN 3123, ISO 3316

12,5" 1/2" 12,5" 1/2"



917-1: délka mimo řadu DIN/ISO

HAZET No.	l mm	EAN-No. 4000896+	€
917-1	45	046362	12,05
917-3	76	046379	12,70
917-5	123	046386	13,55

918 Prodloužení

Made in Germany

- S kuličkovou pojistkou
- Povrch: chromováno, leštěná hlava
- DIN 3123, ISO 3316

12,5" 1/2" 12,5" 1/2"



918-23 délka mimo řadu DIN/ISO

HAZET No.	l mm	EAN-No. 4000896+	€
918-10	248	046416	18,45
918-23	575	046423	46,25

919 Prodloužení · otočné

Made in Germany

- Kulovitý, kónický vnější čtyřhran úhel kyvu na každou stranu 12,5°

12,5" 1/2" 12,5" 1/2"

- Zastrčením nástrčné hlavice až na doraz může být výkyvné prodloužení použito také jako pevné prodloužení
- S kuličkovou pojistkou
- Povrch: chromováno, leštěno

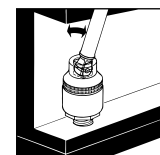

HAZET No.	l mm	EAN-No. 4000896+	€
919- 1	46	046447	16,50
919- 5	123	046461	17,75
919-10	248	046454	23,60



Ruční nářadí

125 1/2 Program nástrčných klíčů



958-28 Prodloužení adaptéru

Made in Germany

- Pro práci na hluboko uložených šroubových spojích, např. u převodovek
- S kuličkovou pojistkou
- Povrch: chromováno

10 3/8 125 1/2



HAZET No.	l mm	EAN-No. 4000896+	€
958-28	700	046706	50,65

900 S Sada nástrčných hlavíc pro rázový a strojový utahovák

Made in Germany

- Kovová schránka (modrá HAZET)
- 2komponentní měkká pěnová vložka

E 125 1/2

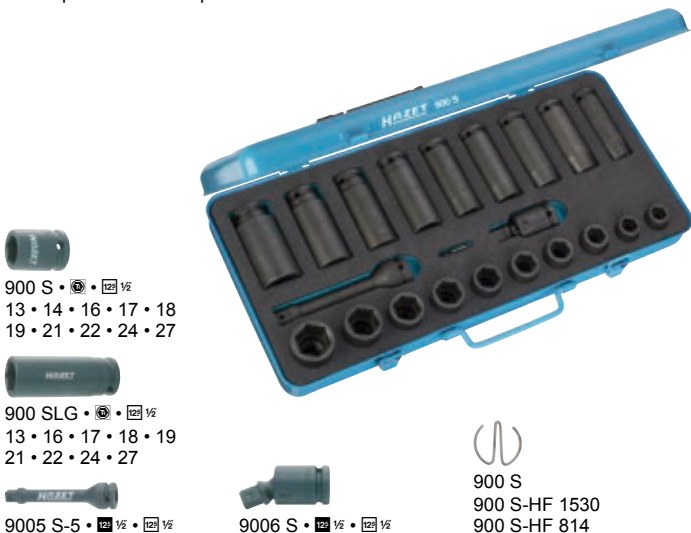

900 S • 125 1/2
13 • 14 • 16 • 17 • 18
19 • 21 • 22 • 24 • 27

900 SLG • 125 1/2
13 • 16 • 17 • 18 • 19
21 • 22 • 24 • 27

9005 S-5 • 125 1/2

9006 S • 125 1/2

900 S
900 S-HF 1530
900 S-HF 814

HAZET No.	d x š x v mm		EAN-No. 4000896+	€
900 S	435x215x62	23	057153	471,20

900 S Nástrčná hlavice pro rázový a strojový utahovák · šestihran

Made in Germany

- S otvorem pro pojistný kolík nebo zajišťovací pružinu a drážku pro O-kroužek
- Povrch: fosfátováno, olejováno
- DIN 3129, ISO 2725-2

125 1/2

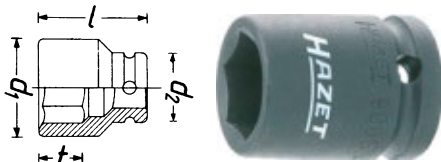

* = Mimo řady DIN

HAZET No.	l mm	d ₁ mm	d ₂ mm	t mm	EAN-No. 4000896+	€
900 S-13	38	20,8	25	10	044146	10,10
900 S-14	38	22,1	25	10	044177	10,60
900 S-15	38	23,5	30	11	044191	10,75
900 S-16	38	24,8	30	11	044214	10,75
900 S-17	38	26,2	30	12	044238	11,95
900 S-18	38	27,5	30	12	044283	11,90
900 S-19	40	28,8	30	15	044306	11,90
900 S-21	40	31,3	30	15	044368	11,90
900 S-22	40	32,5	30	15	044382	11,90
900 S-24	44	35	30	17,5	044429	11,90
900 S-25 *	44	36,3	30	18,5	044450	13,75
900 S-27	45	38,8	30	19,5	044498	15,05
900 S-30	50	42	30	23,3	073207	16,35
900 S-32 *	50	44	30	23	073184	16,35

900 SK Sada nástrčných hlavíc pro rázový a strojový utahovák

Made in Germany

- Zvláště vhodné ve spojení s krátkými rázovými utahovými např. HAZET 9012 A-1 · 9012 M · 9012 M-1 · 9012 MT

125 1/2

- Extra krátké provedení
- S otvorem pro pojistný kolík nebo zajišťovací pružinu a drážku pro O-kroužek
- Povrch: fosfátováno, olejováno
- DIN 3124, ISO 2725-2



13 • 17 • 19 • 21

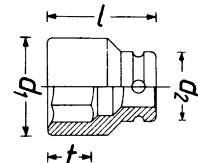

HAZET No.	l mm		EAN-No. 4000896+	€
900 SK/4	29	4	201785	40,10

900 SLG Nástrčná hlavice pro rázový a strojový utahovák · šestihran

Made in Germany

- Dlouhé provedení
- S otvorem pro pojistný kolík nebo zajišťovací pružinu a drážku pro O-kroužek
- Povrch: fosfátováno, olejováno
- DIN 3124, ISO 2725-2

125 1/2

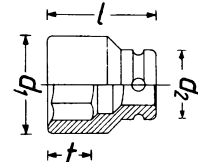

+ = Zesílené provedení s hlubokým šestihranem pro matice kol/šrouby

HAZET No.	l mm	d ₁ mm	d ₂ mm	t mm	EAN-No. 4000896+	€
900 S Lg-13	85	20,8	25	13	044764	21,55
900 S Lg-15	85	23,5	30	18	104277	21,55
900 S Lg-16	85	24,8	30	16	044788	21,55
900 S Lg-17	85	26,2	30	18,5	044801	21,55
900 S Lg-18	85	27,5	30	19	044825	21,55
900 S Lg-19	85	28,8	30	19,5	044849	21,55
900 S Lg-21 +	85	31,3	30	17,5	044863	22,20
900 S Lg-22	85	32,5	30	22	044887	22,20
900 S Lg-24	85	35	30	19,5	044917	24,30
900 S Lg-27	85	38,8	30	29	044931	26,85

900 SLG6 Nástrčná hlavice pro rázový a strojový utahovák · šestihran

Made in Germany

- Ovládání adaptérem pro rázový a strojní utahovák např. HAZET 1003 S-1 nebo nástrčným klíčem s 24 mm umožňuje vysoké přenášení síly pohonem 20 mm = 3/4"



- Dlouhé provedení
- S otvorem pro pojistný kolík nebo zajišťovací pružinu a drážku pro O-kroužek

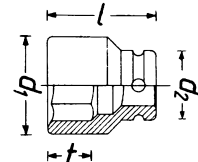
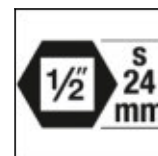

HAZET No.	l mm	d ₁ mm	d ₂ mm	t mm	EAN-No. 4000896+	€
900 S Lg 6-24	85	35	26,9	25	232789	19,50



Ruční nářadí

125 1/2 Program nástrčných klíčů



903 SLG6 Nástrčná hlavice pro rázový a strojový utahovák · šestihran

Made in Germany



- Ovládání adaptérem pro rázový a strojní utahovák např. HAZET 1003 S-1 nebo nástrčným klíčem s 24 mm umožňuje vysoké přenášení síly pohonem 20 mm = 3/4"
- Na nástrčné hlavici umístěný šestihran umožňuje adaptaci na pohon 20 mm = 3/4"
- Otočné plastové pouzdro zvenčí (vyměnitelné) na ochranu disků při nasazování šroubů kol
- Plastová pouzdra s barevným rozlišením pro rychlé nalezení požadované velikosti klíče
- Plastová vložka na ochranu povrchů šroubů kol
- Dlouhé provedení
- S otvorem pro pojistný kolík nebo zajišťovací pružinu a drážku pro O-kroužek
- DIN 3124, ISO 2725-2



HAZET No.	l mm	d ₁ mm	d ₂ mm	f mm	EAN-No. 4000896+	€
• Plastové pouzdro, modré						
903 S Lg 6-17	85	30	27	14	223596	24,50
• Plastové pouzdro, žluté						
903 S Lg 6-19	85	30	27	18	223589	24,50

903 SLG6 Sada nástrčných klíčů pro rázový a strojový utahovák

Made in Germany

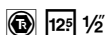

- Ovládání adaptérem pro rázový a strojní utahovák např. HAZET 1003 S-1 nebo nástrčným klíčem s 24 mm umožňuje vysoké přenášení síly pohonem 20 mm = 3/4"
- Na nástrčné hlavici umístěný šestihran umožňuje adaptaci na pohon 20 mm = 3/4"
- Otočné plastové pouzdro zvenčí (vyměnitelné) na ochranu disků při nasazování šroubů kol
- Plastová pouzdra s barevným rozlišením pro rychlé nalezení požadované velikosti klíče
- Plastová vložka na ochranu povrchů šroubů kol
- Dlouhé provedení
- S otvorem pro pojistný kolík nebo zajišťovací pružinu a drážku pro O-kroužek
- DIN 3124, ISO 2725-2



903 SLG6 • E • T • 125 1/2, 17 • 19

1000 S • 20 3/4
1000 S-G 1736
1000 S-H 1736

1003 S-1 • O • 20 3/4

HAZET No.	l mm	d ₁ mm	d ₂ mm	f mm	EAN-No. 4000896+	€
903 S Lg 6/5	5				223602	61,75

904 SLG Nástrčná hlavice pro rázový · strojový utahovák · šestihran · extra dlouhá

Made in Germany



- Plastová vložka na ochranu povrchů šroubů kol
- Bezpečný odstup od blatníku při konečném utahování šroubů momentovým klíčem HAZET – není potřebné prodloužení
- Vnější (otočné) plastové pouzdro na ochranu ráfku
- Extra dlouhé provedení
- S otvorem pro pojistný kolík nebo zajišťovací pružinu a drážku pro O-kroužek
- DIN 3124, ISO 2725-2

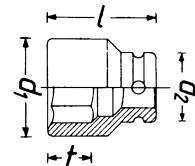
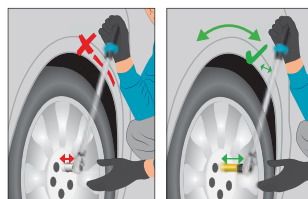

HAZET No.	l mm	d ₁ mm	d ₂ mm	f mm	EAN-No. 4000896+	€
Speciálně pro montáž a demontáž kol s disky AMG resp. hliníkové sportovní disky s hluboko uloženými šrouby kol						
904 S Lg-17	130	28,3	30	18,3	100576	53,40
Speciálně při montáži kol a montáži na SUV, jako např. PORSCHE Cayenne, Macan; AUDI Q7, Q5; VW Touareg						
904 S Lg-19	130	30,8	30	18	203710	53,40

905 SLG Nástrčná hlavice pro rázový · strojový utahovák · hybridní zvláštní profil

Made in Germany



- Optimalizovaný vnější obrys pro lepší ochranu hlubokých otvorů disků
- Použití: Speciálně pro montáž a demontáž hliníkových disků pro šrouby hybridních kol u vozidel MERCEDES-BENZ
- Plastová vložka na ochranu povrchů šroubů kol
- Otočné vnější plastové pouzdro na ochranu disků při nasazení šroubů kola – žádná korozí hliníku díky zamezení ryhám
- Dlouhé provedení
- S otvorem pro pojistný kolík nebo zajišťovací pružinu a drážku pro O-kroužek
- DIN 3124, ISO 2725-2
- Např. pro MERCEDES-BENZ třída C typ 204, 204X · třída E typ 211, 212, 207 · SLK typ 172 · třída M typ 164, 166 · třída S typ 221, 222 · třída CL typ 216

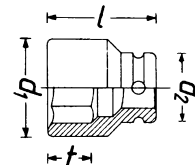

HAZET No.	l mm	d ₁ mm	d ₂ mm	f mm	EAN-No. 4000896+	€
905 S Lg-17	86	28,4	30	18	198795	16,-



905 SLG Nástrčná hlavice pro rázový · strojový utahovák · speciální profil

Made in Germany

- Plastová vložka na ochranu povrchů šroubů kol
- Otočné vnější plastové pouzdro na ochranu disků při nasazení šroubů kola – žádná korozie hliníku díky zamezení rýhám

- Dlouhé provedení
- S otvorem pro pojistný kolík nebo zajišťovací pružinu a drážku pro O-kroužek
- DIN 3124, ISO 2725-1
- Matice kol se speciálním profilem s 21 mm u HYUNDAI i30, Tucson a KIA

E 12⁵ 1/2



360°

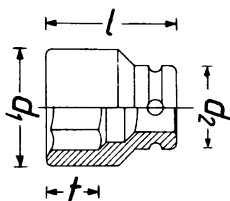

HAZET No.	l mm	d ₁ mm	d ₂ mm	t mm	EAN-No. 4000896+	€
905 S Lg-21	86,8	31	30	19,8	201624	17,15

900 SLG plastová objímka

Made in Germany

HAZET No.	EAN-No. 4000896+	€
• Plastová objímka bílá · pro 903 S Lg-15		
903 S Lg-015	081462	11,15
• Plastová objímka modrá · pro 903 S Lg-17		
903 S Lg-017	045808	5,65
• Plastová objímka žlutá · pro 903 S Lg-19		
903 S Lg-019	045815	5,65
• Plastová objímka červená · pro 903 S Lg-21		
903 S Lg-021	055692	5,65
• Plastová objímka zelená · pro 903 S Lg-22		
903 S Lg-022	155255	5,65
• Plastová objímka bílá · pro 904 S Lg-17		
904 S Lg-017	203352	11,05
• Plastová objímka žlutá · pro 904 S Lg-19		
904 S Lg-019	205523	10,65
• Plastová objímka modrá · pro 905 S Lg-17		
905 S Lg-017	203833	5,50
• Plastová objímka oranžová · pro 905 S Lg-21		
905 S Lg-021	203345	5,35

900 SZ Sada nástrčných hlavic pro rázový a strojový utahovák

Made in Germany

- Povrch: fosfátováno, olejováno
- DIN 3124, ISO 2725-1

E 12⁵ 1/2

900 SZ • • 1/2
24 · 30 · 32 · 36



HAZET No.	€
900 SZ/4	64,05

900 SZ Nástrčná hlavice pro rázový · strojový utahovák · dvojitý šestihran

Made in Germany

12⁵ 1/2

- S otvorem pro pojistný kolík nebo zajišťovací pružinu a drážku pro O-kroužek
- Povrch: fosfátováno, olejováno
- DIN 3124, ISO 2725-2

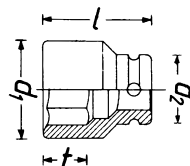

HAZET No.	l mm	d ₁ mm	d ₂ mm	t mm	EAN-No. 4000896+	€
900 S Z-12	38	19,5	25	6,8	061785	10,10
900 S Z-13	38	20,8	25	6,8	061792	10,10
900 S Z-14	38	22,1	25	9,3	061808	10,75
900 S Z-15	38	23,5	30	9,3	061815	10,75
900 S Z-16	38	24,8	30	9,2	061822	10,75
900 S Z-17	38	26,2	30	9,2	061839	11,90
900 S Z-18	38	27,5	30	10,7	061846	11,90
900 S Z-19	40	28,8	30	11,6	061853	11,90
900 S Z-21	40	30	31,3	11,7	075362	11,90
900 S Z-22	40	30	32,5	11,7	075379	11,90
900 S Z-24	44	35	30	17,5	115556	13,75
900 S Z-27	45	38,8	30	17,9	115822	13,75
900 S Z-30	50	42	30	23,3	086573	17,50
900 S Z-32	50	44,5	30	22,2	115921	23,15
900 S Z-34	55	47,5	30	22,2	116034	23,15
900 S Z-36	60	50	30	25	100132	29,55

HAZET No.	s mm	l mm	d ₁ mm	d ₂ mm	t mm	EAN-No. 4000896+	€
3047-36	36	60	47	30	25	190683	19,25

900 SZ6 Nástrčná hlavice pro rázový · strojový utahovák · dvojitý šestihran

Made in Germany

12⁵ 1/2

- Ovládání adaptérem pro rázový a strojní utahovák např. HAZET 1003 S-1 nebo nástrčným klíčem s 24 mm umožňuje vysoké přenášení síly pohonem 20 mm = 3/4"

- Na nástrčné hlavici přítomný šestihran umožňuje adaptaci na pohon 20 mm = 3/4"
- Krátké provedení
- S otvorem pro pojistný kolík nebo zajišťovací pružinu a drážku pro O-kroužek
- 2komponentní měkká pěnová vložka
- Povrch: fosfátováno, olejováno
- DIN 3124, ISO 2725-2

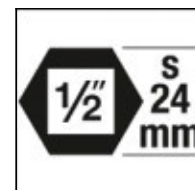

900 SZ6 • • 1/2 19 · 21 · 22 · 24 27 · 30 · 32 · 36	1000 S • 3/4 1000 S-G 1736 1000 S-H 1736	1003 S-1 • 3/4
---	---	-----------------

HAZET No.	€
900 SZ 6/11	147,20



900 SZ6 Nástrčná hlavice pro rázový · strojový utahovák · dvojité šestihran

Made in Germany

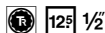

Ovládání adaptérem pro rázový a strojní utahovák např. HAZET 1003 S-1 nebo nástrčným klíčem s 24 mm umožňuje vysoké přenesení síly pohonem 20 mm = 3/4"

Na nástrčné hlavici přítomný šestihran umožňuje adaptaci na pohon 20 mm = 3/4"

Krátké provedení

S otvorem pro pojistný kolík nebo zajišťovací pružinu a drážku pro O-kroužek

Povrch: fosfátováno, olejováno

DIN 3124, ISO 2725-2

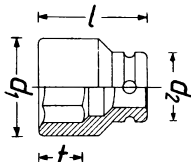

HAZET No.	l mm	d1 mm	d2 mm	t mm	EAN-No. 4000896+	€
900 SZ 6-19	40	30,5	27	11,6	225293	12,60
900 SZ 6-21	40	32,5	27	11,7	225309	12,60
900 SZ 6-22	40	32,5	27	11,7	225316	12,60
900 SZ 6-24	44	36	27	17,5	225323	14,50
900 SZ 6-27	45	40	27	17,9	225330	14,50
900 SZ 6-30	50	43	27	23,3	225347	18,20
900 SZ 6-32	50	45	27	22,2	225354	23,80
900 SZ 6-36	60	53	27	25	225361	30,25

900 S-E Nástrčná hlavice pro rázový · strojový utahovák · TORX®

Made in Germany

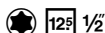

S otvorem pro pojistný kolík nebo zajišťovací pružinu a drážku pro O-kroužek

Povrch: fosfátováno, olejováno

DIN 3124, ISO 2725-2

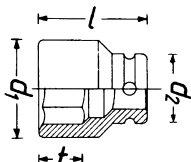

HAZET No.	l mm	d1 mm	d2 mm	mm	EAN-No. 4000896+	€
900 S-E 10	38	14	25	9,42	044542	13,50
900 S-E 12	38	15,9	25	11,17	044566	13,85
900 S-E 14	38	17,7	25	12,90	044580	13,85
900 S-E 16	38	20	25	14,76	044603	13,85
900 S-E 18	38	22	30	16,70	044627	14,55
900 S-E 20	38	24,5	30	18,49	044641	14,55
900 S-E 24	41,2	30	30	22,16	044665	21,40

985 S Nástrčná hlavice pro rázový · strojový utahovák

Made in Germany

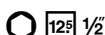

Pohon volitelně s 12,5 mm = 1/2" nebo 24 mm,

Volitelně s adaptérem HAZET 1003 S-1

Krátké provedení

S otvorem pro pojistný kolík nebo zajišťovací pružinu a drážku pro O-kroužek

Povrch: fosfátováno, olejováno

DIN 3124, ISO 2725-2

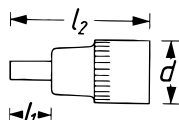
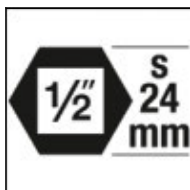

985 S Nástrčná hlavice pro rázový · strojový utahovák

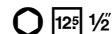

HAZET No.	S mm	l1 mm	l2 mm	EAN-No. 4000896+	€
985 S-14	14	9	45	211968	14,90
985 S-17	17	11	45	211975	15,45
985 S-19	19	13	45	211982	15,60
985 S-22	22	20,5	45	218219	18,-
985 S-24	24	-	45	218226	18,30

Made in Germany

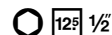

Pohon volitelně s 12,5 mm = 1/2" nebo 24 mm,

Volitelně s adaptérem HAZET 1003 S-1

Dlouhé provedení

S otvorem pro pojistný kolík nebo zajišťovací pružinu a drážku pro O-kroužek

Povrch: fosfátováno, olejováno

DIN 3124, ISO 2725-2

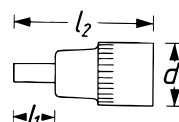

HAZET No.	S mm	l1 mm	l2 mm	EAN-No. 4000896+	€
985 S-14 Lg	14	9	75	211999	17,15
985 S-17 Lg	17	11	75	212002	17,45
985 S-19 Lg	19	13	75	212019	17,90

Made in Germany



20 = 3/4" pohon umožňuje přenos velkých uvolňovacích sil

Pohon volitelně s 12,5 mm = 1/2" nebo 24 mm,

Volitelně s adaptérem HAZET 1003 S-1

S otvorem pro pojistný kolík nebo zajišťovací pružinu a drážku pro O-kroužek

Povrch: fosfátováno, olejováno

DIN 3124, ISO 2725-2

Obsah:

s 14, 17, 19 mm v krátkém a dlouhém provedení

1 adaptér 20 = 3/4" na s 24 mm

2 pojistné kolíky

2 O-kroužky

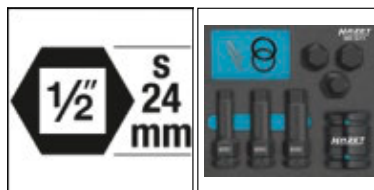

985 S · O · 125 1/2
14 · 17 · 19

985 S · O · 125 1/2
14 · 17 · 19

1000 S · 20 3/4
1000 S-G 1736
1000 S-H 1736

1003 S-1 · O · 20 3/4

HAZET No.		EAN-No. 4000896+	€
985 S/11	11	211951	131,60



990 S Nástrčná hlavice pro rázový · strojový utahovák

Made in Germany

- Volitelně □ pohon 12,5 = 1/2" nebo ● 24 mm
- Krátké provedení
- S otvorem pro pojistný kolík nebo zajišťovací pružinu a drážku pro O-kroužek
- Povrch: fosfátováno, olejováno
- DIN 3124, ISO 2725-2

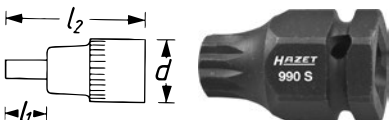
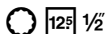

HAZET No.	l ₁ mm	l ₂ mm	EAN-No. 4000896+	€
VW Passat 3C šroubový spoj nosičů brzdý vzadu a šroubový spoj tlumičů vpředu, VW T4 dolní nosný kloub. Kontrovaní tlumičů u vozidel VW Golf 5, 6, Polo 9N, 9N2, AUDI A3 Typ 8P, TT a také SEAT León				
990 S-14	4	43	160846	14,40
Brzdový systém, hnací kolo vačkového hřídele a zadní třmen kotoučové brzdý např. VW Touareg a Phaeton				
990 S-16	5	43	160853	14,45
Demontáž a montáž jednotky ložiska kola / nábojové jednotky např. VW Touran r. v. 2004 →, AUDI A3 r. v. 2004 →, Golf 5 a ŠKODA se stejnou konstrukcí				
990 S-18	6	43	160860	14,55

Made in Germany

- Volitelně □ pohon 12,5 = 1/2" nebo ● 24 mm
- Dlouhé provedení
- S otvorem pro pojistný kolík nebo zajišťovací pružinu a drážku pro O-kroužek
- Povrch: fosfátováno, olejováno
- DIN 3124, ISO 2725-2

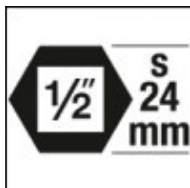
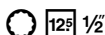

HAZET No.	l ₁ mm	l ₂ mm	EAN-No. 4000896+	€
Šroubový spoj nosičů brzdý vzadu a šroubový spoj tlumičů vpředu u vozidel VW Passat 3C Setrvačnick MB 541-542-904 Kontrovaní tlumičů u vozidel VW Golf 5, 6, Polo 9N, 9N2, AUDI A3 typ 8P, TT, SEAT León				
990 S-14 Lg	39,7	75	161003	16,-
Brzdový systém, hnací kolo vačkového hřídele a zadní třmen kotoučové brzdý např. VW T5 r. v. 2004 → 2,5 TDI kód motoru: AXD, BNZ, Touareg r. v. 2003 → kód motoru: BAC, BPE a Phaeton, setrvačnick Atego.				
990 S-16 Lg	40,6	75	161010	16,25
Podvozek a pro demontáž a montáž jednotky ložisek kol / nábojové jednotky např. u vozidel VW Touran r. v. 2004 →, AUDI A3 r. v. 2004, Golf 5 a ŠKODA se stejnou konstrukcí				
990 S-18 Lg	41,1	75	161027	16,30

990 S Sada nástrčných klíčů pro rázový · strojový utahovák

Made in Germany

- □ 20 = 3/4" pohon umožňuje přenos velkých uvolňovacích sil

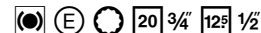

- Volitelně □ pohon 12,5 = 1/2" nebo ● 24 mm
- S otvorem pro pojistný kolík nebo zajišťovací pružinu a drážku pro O-kroužek
- Safety-Insert-System, 2komponentní vložka z měkké pěny. Vložka vhodná také pro HAZET-Assistent
- Povrch: fosfátováno, olejováno
- DIN 3124, ISO 2725-2
- Demontáž a montáž jednotky ložiska kola / nábojové jednotky
- Pro např. **AUDI A3** r. v. 2004 →, **VW Touran** r. v. 2004 →, **Golf 5** r. v. 2003 →, **ŠKODA Octavia** r. v. 2008 →, **SEAT León** r. v. 2005 →
- **990 S-14: VW Passat 3C** šroubový spoj nosičů brzdý vzadu a šroubový spoj tlumičů vpředu, **VW T4** dolní nosný kloub. **Kontrovaní tlumičů u vozidel VW Golf 5, 6, Polo 9N, 9N2, AUDI A3 Typ 8P, TT a také SEAT León**
- **990 S-16: brzdový systém, hnací kolo vačkového hřídele a zadní třmen kotoučové brzdý např. VW Touareg a Phaeton**
- **990 S-18** Demontáž a montáž jednotky ložiska kola / nábojové jednotky např. **VW Touran** r. v. 2004 →, **AUDI A3** r. v. 2004 →, **Golf 5** a také se stejnou konstrukcí **ŠKODA**
- **990 S-14 Lg: šroubový spoj nosičů brzdý vzadu a šroubový spoj tlumičů vpředu u vozidel VW Passat 3C** setrvačnick MB 541-542-904
- **Kontrovaní tlumičů u vozidel VW Golf 5, 6, Polo 9N, 9N2, AUDI A3 typ 8P, TT, SEAT León**
- **990 S-16 Lg: brzdový systém, hnací kolo vačkového hřídele a zadní třmen kotoučové brzdý např. VW T5 r. v. 2004 → 2,5 TDI kód motoru: AXD, BNZ, Touareg r. v. 2003 → kód motoru: BAC, BPE a Phaeton, setrvačnick Atego.**
- **990 S-18 Lg: podvozek a pro demontáž a montáž jednotky ložisek kol / nábojové jednotky např. u vozidel VW Touran r. v. 2004 →, AUDI A3 r. v. 2004, Golf 5 a také se stejnou konstrukcí ŠKODA**

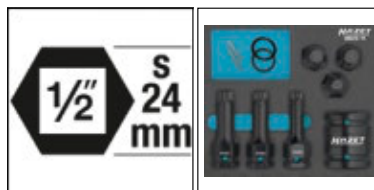

990 S · □ · □ 1/2", M 14 · M 16 · M 18	990 S · □ · □ 1/2", M 14 · M 16 · M 18	1000 S · □ · □ 3/4", 1000 S-G 1736 1000 S-H 1736	1003 S-1 · □ · □ 3/4"
---	---	--	------------------------------

HAZET No.	€	EAN-No. 4000896+	€
990 S/11	11	162406	116,10





Ruční nářadí

12⁵ 1/2 Program nástrčných klíčů



995 S Nástrčná hlavice pro rázový · strojový utahovák · TORX®

Made in Germany

- Krátké provedení
- S otvorem pro pojistný kolík nebo zajišťovací pružinu a drážku pro O-kroužek
- Povrch: fosfátováno, olejováno
- DIN 3124, ISO 2725-1

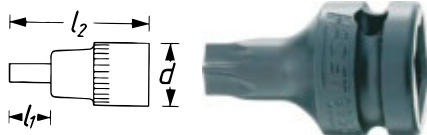

12⁵ 1/2

HAZET No.	l ₁ mm	l ₂ mm	d mm	mm	EAN-No. 4000896+	€
995 S-T 30	21,4	40	25,1	5,52	047666	16,20
995 S-T 40	21,1	40	25,1	6,65	047680	18,20
995 S-T 45	21,1	40	25,1	7,82	057597	18,30
995 S-T 50	22,4	40	25,1	8,83	047703	18,30
995 S-T 55	22,4	40	25,1	11,22	047727	26,15
995 S-T 60	22,1	40	25,1	13,25	047741	26,15

9007 S Adaptér pro rázový · strojový utahovák

Made in Germany

- S otvorem pro pojistný kolík nebo zajišťovací pružinu a drážku pro O-kroužek
- Povrch: fosfátováno, olejováno



12⁵ 1/2

HAZET No.	l mm	EAN-No. 4000896+	€
• ■ Pohon 10 = 3/8" – □ pohon 12,5 = 1/2"			
9007 S	37	072545	15,95
• ■ Pohon 20 = 3/4" – □ pohon 12,5 = 1/2"			
9007 S-1	49	043217	18,-

9006 S Kloubový díl pro rázový · strojový utahovák

Made in Germany

- S kloubem – pro použití na těžko přístupných místech a pro obejití rušivých hran
- S otvorem pro pojistný kolík nebo zajišťovací pružinu a drážku pro O-kroužek
- Povrch: mořeno, olejováno



12⁵ 1/2 12⁵ 1/2

HAZET No.	l mm	EAN-No. 4000896+	€
• Úhel natočení 25°			
9006 S	69	043170	55,-

9005 S Prodloužení pro rázový · strojový utahovák

Made in Germany

- S otvorem pro pojistný kolík nebo zajišťovací pružinu a drážku pro O-kroužek
- Povrch: fosfátováno, olejováno



12⁵ 1/2 12⁵ 1/2

HAZET No.	l mm	EAN-No. 4000896+	€
9005 S-5	130	043163	33,50

900 S O-kroužek a spojovací kolík

Made in Germany

12⁵ 1/2



HAZET No.	mm	EAN-No. 4000896+	€
• Pro nástrčné hlavice □ 10 = 3/8" · 12,5 = 1/2" 8 – 14 mm, 13 mm dlouhý tvar, E 10 – E 16, T 30 – T 60			
900 S-G 1014	Ø 19x4	044689	1,55
• Pro nástrčné hlavice □ 10 = 3/8" · 12,5 = 1/2" 15 – 27 mm, 16 – 27 mm dlouhý tvar, E 18 – E 24, prodloužení, kloubové prvky, adaptér			
900 S-G 1527	Ø 24x4	044696	1,55
• Spojovací kolík pro nástrčné hlavice □ 10 = 3/8" · 12,5 = 1/2" 8 – 14 mm 13 mm dlouhý tvar · E 10 – E 16 T 30 – T 60			
900 S-H 1014	Ø 3x20	044702	0,75
• Spojovací kolík pro nástrčné hlavice □ 10 = 3/8" · 12,5 = 1/2" 15 – 27 mm · 16 – 27 mm dlouhý tvar E 18 – E 24 prodloužení · kloubové prvky · adaptér			
900 S-H 1527	Ø 3x26	044719	0,75

900 S Pojistná pružina

Made in Germany

- Pro strojně ovládané nástavce nástrčných klíčů podle DIN 3129



HAZET No.	mm	EAN-No. 4000896+	€
• Pojistná pružina pro nástrčné hlavice □ 10 = 3/8" · 12,5 = 1/2" 8 – 14 mm · E 10 – E 16 Pro 900 S			
900 S-HF 814	Ø 21	044733	3,80
• Pojistná pružina pro nástrčné hlavice □ 10 = 3/8" · 12,5 = 1/2" 15 – 27 mm · E 18 – 24 prodloužení · kloubové prvky · adaptér			
900 S-HF 1530	Ø 25	044726	3,80





20 3/4" Program nástrčných klíčů

1000 Sada nástrčných klíčů

Made in Germany

- Kovová schránka (modrá HAZET)
- 2komponentní měkká pěnová vložka

ⓔ ● 20 3/4"



1000 • ● • 20 3/4"
22 • 24 • 27 • 30 • 32
36 • 38 • 41 • 46 • 50

1015-1 • 20 3/4"

1017-8 • 20 3/4" • 20 3/4"

1014

1016 • 20 3/4"

1018 • 20 3/4" • 20 3/4"

HAZET No.	d x š x v mm		EAN-No. 4000896+	€
1000	578x235x88	15	000616	628,-

1002 Sada nástrčných klíčů

Made in Germany

- Kovová schránka (modrá HAZET)
- 2komponentní měkká pěnová vložka

ⓔ ● 20 3/4"



1000 • ● • 20 3/4"
22 • 24 • 27 • 30
32 • 36 • 38 • 41
46 • 50 • 55 • 60

1015-1 • 20 3/4"

1017-8 • 20 3/4" • 20 3/4"

1018 • 20 3/4" • 20 3/4"

1014

1016 • 20 3/4"

1021 • 20 3/4" • 20 3/4"

HAZET No.	d x š x v mm		EAN-No. 4000896+	€
1002	578x235x88	18	001736	796,-

1000 Z Sada nástrčných klíčů

Made in Germany

- S nástrčnými hlavicemi s dvojitým 6hranem
- Kovová schránka (modrá HAZET)
- 2komponentní měkká pěnová vložka

ⓔ ● 20 3/4"



1000 Z Sada nástrčných hlavic

ⓔ ● 20 3/4"



1000 Z • ● • 20 3/4"
22 • 24 • 27 • 30 • 32
36 • 38 • 41 • 46 • 50

1015-1 • 20 3/4"

1017-8 • 20 3/4" • 20 3/4"

1014

1016 • 20 3/4"

1018 • 20 3/4" • 20 3/4"

HAZET No.	d x š x v mm		EAN-No. 4000896+	€
1000 Z	578x235x88	15	001477	628,-

1002 Z Sada nástrčných klíčů

Made in Germany

- S nástrčnými hlavicemi s dvojitým 6hranem
- Kovová schránka (modrá HAZET)
- 2komponentní měkká pěnová vložka

ⓔ 20 3/4"

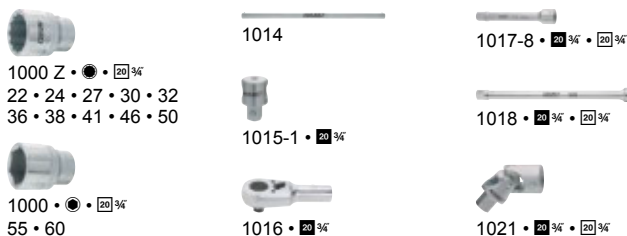

1000 Z • ● • 20 3/4"
22 • 24 • 27 • 30 • 32
36 • 38 • 41 • 46 • 50

1014

1017-8 • 20 3/4" • 20 3/4"

1015-1 • 20 3/4"

1018 • 20 3/4" • 20 3/4"

1000 • ● • 20 3/4"
55 • 60

1016 • 20 3/4"

1021 • 20 3/4" • 20 3/4"

HAZET No.	d x š x v mm		EAN-No. 4000896+	€
1002 Z	578x235x88	18	001743	796,-

1000 AZ Sada nástrčných klíčů

Made in Germany

- S nástrčnými hlavicemi s dvojitým 6hranem
- Americké rozměry
- Kovová schránka (modrá HAZET)
- 2komponentní měkká pěnová vložka

ⓔ ● 20 3/4"

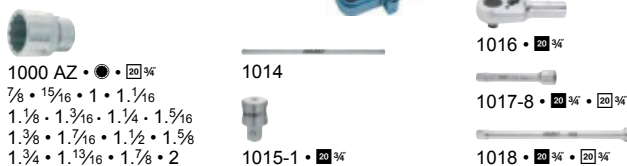

1000 AZ • ● • 20 3/4"
7/8 • 1 1/16 • 1 • 1 1/16
1 1/8 • 1 3/16 • 1 1/4 • 1 5/16
1 3/8 • 1 7/16 • 1 1/2 • 1 5/8
1 3/4 • 1 13/16 • 1 7/8 • 2

1014

1016 • 20 3/4"

1017-8 • 20 3/4" • 20 3/4"

1015-1 • 20 3/4"

1018 • 20 3/4" • 20 3/4"

HAZET No.	d x š x v mm		EAN-No. 4000896+	€
1000 AZ	578x235x88	21	000982	794,-



1016 Přepínací hlava ráčny

Made in Germany

ⓔ 20 3/4"

- Počet zubů: 32
- Úhel ovládání: 11,25°
- Díky s odjišťovacím čepem pro kolíkovou pojistku, výstup s kolíkovou pojistkou
- Povrch: chromováno
- DIN 3122, ISO 3315



HAZET No.	l mm	EAN-No. 4000896+	€
1016	165	001941	141,50

Opotřeбені? – Žádný problém!

- Nářadí HAZET je vyrobeno v nejvyšší kvalitě. Při dlouhém, intenzivním namáhání dochází i u vysoce kvalitních nástrojů k určitému opotřeбені.
- Proto nabízíme pro mnoho našich nástrojů náhradní díly a sady náhradních dílů.

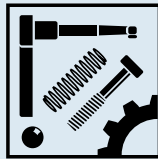

Nezapomeňte na náš obchod s náhradními díly www.hazet.de/ersatzteil-shop

Úspora nákladů – udržitelnost – šetří zdroje!
Abyste se mohli ze svého nářadí HAZET dlouho těšit

1016 Sada náhradních dílů

Made in Germany

- Počet zubů: 32
- Úhel ovládání: 11,25°

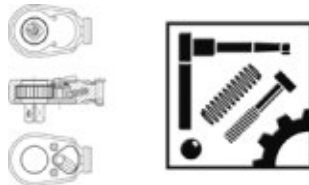

HAZET No.	EAN-No. 4000896+	€
• Sada náhradních dílů ovládací páky obsah sady: ovládací páka · šrouby · kulička · tlačná pružina Pro přepínací ráčnu HAZET 1016 · 1016/2 Pro momentový klíč HAZET 5145-3 CT · 6132-1 CT · 6143 CT · 6143-1 CT · 6144 CT · 6144-1 CT · 6145 CT · 6145-1 CT · 6146-1 CT		
1016/6	001972	3,85
• Sada náhradních dílů kolečka ráčny 20 = 3/4" ■ obsah sady: Knarrkolečko ráčny · fixační prvek · ovládací páka · šrouby · kulička · tlačná pružina Pro přepínací ráčnu HAZET 1016 · 1016/2 Pro momentové klíče HAZET 5145-3 CT · 6132-1 CT · 6143 CT · 6143-1 CT · 6144 CT · 6144-1 CT · 6145 CT · 6145-1 CT · 6146-1 CT		
1016/8 N	001989	55,-

1016 Přepínací hlava ráčny s otočnou tyčí

Made in Germany

ⓔ 20 3/4"

- Počet zubů: 32
- Úhel ovládání: 11,25°
- Díky s odjišťovacím čepem pro kolíkovou pojistku, výstup s kolíkovou pojistkou
- Povrch: chromováno, leštěno



HAZET No.	l mm	EAN-No. 4000896+	€
1016/2	620	001965	171,40

1015 Posuvný kus s otočnou tyčí

Made in Germany

ⓔ 20 3/4"

- Otočná tyč HAZET 1014 a posuvný díl 1015-1
- S kolíkovou pojistkou
- Povrch: chromováno, leštěno
- DIN 3122



HAZET No.	l mm	EAN-No. 4000896+	€
1015/2	500	001927	57,55

1015 Posuvný kus

Made in Germany

ⓔ 20 3/4"

- Pro otočnou tyč HAZET 1014, resp. 1014 P
- S kolíkovou pojistkou
- Povrch: chromováno, leštěno
- DIN 3122



HAZET No.	l mm	EAN-No. 4000896+	€
1015-1	60	001910	27,60

1014 Otočná tyč

Made in Germany

- Pro šoupátko HAZET 1015-1 nebo ráčnovou hlavu HAZET 1016
- Se zajištěním kuličkou a kolíkem
- Povrch: chromováno
- DIN 3122



HAZET No.	l mm	EAN-No. 4000896+	€
1014	500	001897	30,15

1000 Nástrčná hlavice · šestihran

Made in Germany

ⓔ 20 3/4"

- Krátké provedení
- S rýhováním
- S odjišťovacím čepem pro kolíkovou pojistku
- Povrch: chromováno, leštěno
- DIN 3124, ISO 2725-1

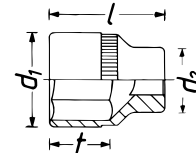

* = Mimo řady DIN

HAZET No.	l mm	d1 mm	d2 mm	t mm	EAN-No. 4000896+	€
1000-19 *	52	28	33,2	14,5	000623	18,45
1000-21	52	31	33,2	14	000647	18,45
1000-22	52	32	33,2	14	000654	18,45
1000-24	52	34	36	16,5	000661	19,25
1000-27	54	38	35	19,3	000678	21,75
1000-30	55	42	36	21,5	000692	25,65
1000-32	58	44,5	36	24	000708	27,30
1000-33	59	46	36	24,5	000715	27,30
1000-34	60	47,5	36	25,5	000722	27,60
1000-36	61,5	49,5	38	26,5	000746	31,55
1000-38 *	65	52,5	39	29	000760	34,55
1000-41	68,5	55,5	39	32	000784	37,70
1000-42 *	70	57,5	41	32	000791	39,30
1000-46	73	62	44	34	000807	42,10
1000-50	76	67	45	37,1	000814	47,80
1000-55 *	82	73,5	45	40,8	000821	54,95
1000-60 *	88	80	45	44,9	000838	59,75



1000 Z Nástrčná hlavice · dvojitý šestihran

Made in Germany

- Krátké provedení
- S rýhováním
- S odjišťovacím čepem pro kolíkovou pojistku
- Povrch: chromováno, leštěno
- DIN 3124, ISO 2725-1

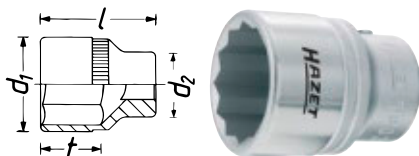

20 3/4"

* = Mimo řady DIN

HAZET No.	l mm	d ₁ mm	d ₂ mm	f mm	EAN-No. 4000896+	€
1000 Z-22	52	32	33,2	13,5	001507	18,45
1000 Z-24	52	34	36	16	001521	19,25
1000 Z-27	54	38	35	18,8	001552	21,75
1000 Z-30	55	42	36	21	001583	25,65
1000 Z-32	58	44,5	36	23,4	001590	27,30
1000 Z-34	60	47,5	36	24,8	001613	27,60
1000 Z-35 *	61,5	48,5	35,5	25,8	001620	27,75
1000 Z-36	61,5	49,5	36	25,7	001637	31,55
1000 Z-38 *	65	52,5	38	28,3	001644	34,55
1000 Z-41	68,5	55,5	39	31,2	001651	37,70
1000 Z-46	73	62	44	34	001675	42,10
1000 Z-50	76	67	45	37,1	001699	47,80
1000 Z-55	82	73,5	45	40,8	001712	54,95

1000 AZ Nástrčná hlavice · dvojitý šestihran

Made in Germany

- Krátké provedení
- Americké rozměry
- S rýhováním
- S odjišťovacím čepem pro kolíkovou pojistku
- Povrch: chromováno, leštěno
- DIN 3124, ISO 2725-1

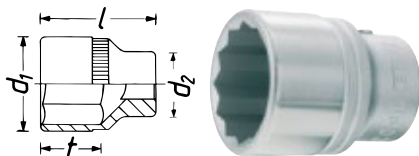

20 3/4"

HAZET No.	l mm	d ₁ mm	d ₂ mm	f mm	EAN-No. 4000896+	€
1000 AZ-7/8	52	32	33,2	13,5	001170	20,15
1000 AZ-15/16	52	34	36	16,9	001132	21,85
1000 AZ-1	52	36,5	33,2	16,9	000999	22,80
1000 AZ-1.1/16	54	38	35	18,8	001002	24,55
1000 AZ-1.1/8	55	40	36	20,8	001033	25,65
1000 AZ-1.3/16	55	42	36	21	001064	25,65
1000 AZ-1.1/4	58	44,5	36	23,4	001026	27,30
1000 AZ-1.5/16	59	46	36	23,9	001095	27,30
1000 AZ-1.3/8	61,5	48,5	36	25,8	001088	27,75
1000 AZ-1.7/16	63	50	36	27,2	001118	31,55
1000 AZ-1.1/2	65	52,5	38	28,6	001019	32,80
1000 AZ-1.9/16	68,5	55,5	39	31,2	001101	37,70
1000 AZ-1.3/4	72	60	41	33,6	001071	41,05
1000 AZ-1.13/16	73	62	44	34	001057	42,10
1000 AZ-1.7/8	73	64	45	35	001125	43,95
1000 AZ-2	78	68	45	38,7	001149	47,95

1010 Nástrčná hlavice

Made in Germany

- Krátké provedení
- S rýhováním
- S odjišťovacím čepem pro kolíkovou pojistku
- Povrch: chromováno, špička mořená
- DIN 7422, DIN 3124, ISO 2725-1

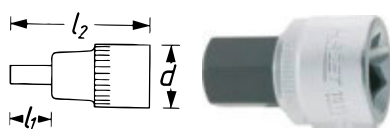

20 3/4"

HAZET No.	S mm	l ₁ mm	l ₂ mm	d mm	EAN-No. 4000896+	€
1010-14	14	16,7	54,5	36	001842	29,75
1010-17	17	19,7	54,5	36	001859	29,75
1010-19	19	21,7	56,5	36	001866	32,55
1010-22	22	24,7	56,5	36	001873	32,55

2784 Nástrčná hlavice pro brzdové třmeny

Made in Germany

- Pohon umožňuje přenos velkých uvolňovacích sil

20 3/4"

- Umožňuje kontrolované utažení šroubů s utahovacím momentem stanoveným výrobcem (dodrže hodnoty zadané výrobcem) např. s momentovým klíčem HAZET 6144-1 CT
- S rýhováním
- S odjišťovacím čepem pro kolíkovou pojistku
- DIN 3124, ISO 2725-1



HAZET No.	S mm	l ₁ mm	l ₂ mm	d mm	EAN-No. 4000896+	€
2784-14	14	60	112	33,2	155583	33,40

Povrchová úprava TiN

TiN

Proč povrchová úprava TiN (nitrid titanu)?

- Speciální metoda velmi tvrdé povrchové úpravy TiN dosahuje extrémně vysoké přilnavosti a ořezuvzdornosti vrstvy
- Optimálně vhodné při dlouhodobém zatížení, např. sériovém šroubování v průmyslu a dálnách
- Vyšší ochrana proti opotřebení zajišťuje delší životnost
- Perfektní přesnost díky optimální tloušťce vrstvy
- Vyšší utahovací moment
- Optimální ochrana proti korozi

Nástrčné hlavice s TiN úpravou

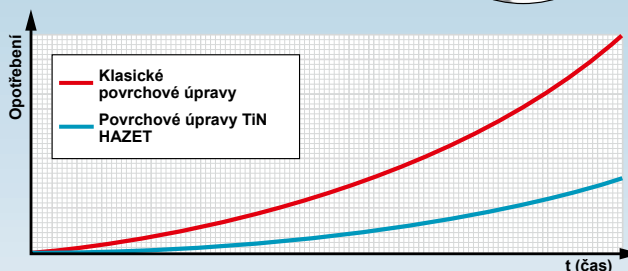
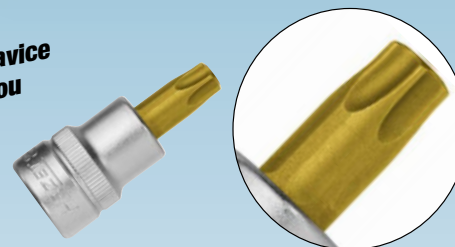

1012 Nástrčná hlavice TORX®

Made in Germany

- Krátké provedení
- S rýhováním
- S odjišťovacím čepem pro kolíkovou pojistku
- Povrch: TiN
- DIN 3124, ISO 2725-1

TiN 20 3/4"

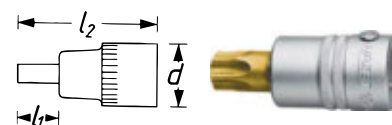

HAZET No.	l ₁ mm	l ₂ mm	mm	EAN-No. 4000896+	€
1012-T 60	28	80	13,25	087488	34,45
1012-T 70	28	80	15,54	087495	35,55
1012-T 80	28	80	17,59	087501	36,45
1012-T 90	28	80	19,95	087518	38,25
1012-T 100	28	80	22,15	087525	40,05



Ruční nářadí

20 3/4" Program nástrčných klíčů



1058 Adaptér

Made in Germany

- S odjišťovacím čepem pro kolíkovou pojistku
- Povrch: chromováno
- DIN 3123, ISO 3316

20 3/4"



HAZET No.	l mm	EAN-No. 4000896+	€
<ul style="list-style-type: none"> Pohon 25 = 1" – □ pohon 20 = 3/4" Pojistný kolík 			
1058-1	60,6	002061	30,-
<ul style="list-style-type: none"> Pohon 12,5 = 1/2" – □ pohon 20 = 3/4" Kuličková pojistka Vyměnitelný čtyřhran 1058-02 A 			
1058-2	52,3	002078	20,90
<ul style="list-style-type: none"> Vtlačovací čtyřhran pro adaptér HAZET 1058-2 			
1058-02 A	-	233557	7,30

1021 Univerzální kloub

Made in Germany

- S kloubem – pro použití na těžko přístupných místech a pro obojí rušivých hran
- Pohon s odjišťovacím čepem pro kolíkovou pojistku, výstup s kolíkovou pojistkou
- Povrch: chromováno
- DIN 3123, ISO 3316

20 3/4" 20 3/4"



HAZET No.	l mm	EAN-No. 4000896+	€
1021	105	002054	89,05

1017 Prodloužení

Made in Germany

- Pohon s odjišťovacím čepem pro kolíkovou pojistku, výstup s kolíkovou pojistkou
- Povrch: chromováno, leštěno

20 3/4" 20 3/4"



1017-8 = DIN 3123, ISO 3316

HAZET No.	l mm	EAN-No. 4000896+	€
1017-3	75	001996	27,75
1017-8	200	002016	36,70

1018 Prodloužení

Made in Germany

- Pohon s odjišťovacím čepem pro kolíkovou pojistku, výstup s kolíkovou pojistkou
- DIN 3123, ISO 3316

20 3/4" 20 3/4"



HAZET No.	l mm	EAN-No. 4000896+	€
1018	400	002030	50,85

1000 S Nástrčná hlavice pro rázový a strojový utahovák · šestihran

Made in Germany

- Pro extrémně vysoké zatížení
- Krátké provedení
- S otvorem pro pojistný kolík nebo zajišťovací pružinu a drážku pro O-kroužek
- Povrch: fosfátováno, olejováno
- DIN 3129, ISO 2725-2

20 3/4"

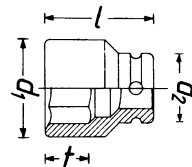

* = Mimo řady DIN

HAZET No.	l mm	d ₁ mm	d ₂ mm	t mm	EAN-No. 4000896+	€
1000 S-19 *	48	32	44	13	001231	32,25
1000 S-22	50	36,5	44	16	001248	32,25
1000 S-24	50	39,5	44	17	001255	32,25
1000 S-27	51	43,5	44	19	001262	32,65
1000 S-28 *	54	45	44	19	001279	34,05
1000 S-30	54	47,4	44	21	001293	34,05
1000 S-32	54	49,9	44	21	001309	36,55
1000 S-33 *	54	51,5	44	16	001316	39,75
1000 S-34	54	52,4	44	16,8	001323	45,35
1000 S-36	57	54,9	44	23	001330	45,35

1000 SLG Nástrčná hlavice pro rázový a strojový utahovák · šestihran

Made in Germany

- Dlouhé provedení
- S otvorem pro pojistný kolík nebo zajišťovací pružinu a drážku pro O-kroužek
- Povrch: fosfátováno, olejováno
- DIN 3129, ISO 2725-2

20 3/4"

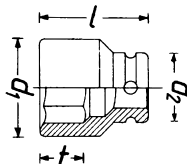

HAZET No.	l mm	d ₁ mm	d ₂ mm	t mm	EAN-No. 4000896+	€
1000 S Lg-24	100	39,5	44	17	001392	50,95
1000 S Lg-27	100	43,5	44	19	001408	50,95
1000 S Lg-30	100	47,5	44	21	001422	54,50
1000 S Lg-32	100	50	44	21	001439	64,35
1000 S Lg-33	100	51,5	44	21	001446	64,35
1000 S Lg-36	100	55	44	23	001460	75,40

1004 S Nástrčná hlavice pro rázový a strojový utahovák · šestihran

Made in Germany

- Např. pro hluboko položené kolové šrouby / matice na užitkových motorových vozidlech
- Extra dlouhé provedení
- S otvorem pro pojistný kolík nebo zajišťovací pružinu a drážku pro O-kroužek
- Povrch: fosfátováno, olejováno
- DIN 3129, ISO 2725-2

20 3/4"

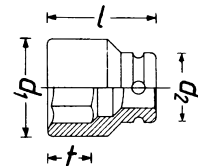

HAZET No.	l mm	d ₁ mm	d ₂ mm	t mm	EAN-No. 4000896+	€
1004 S-32	400	48	44	32	055784	100,60
1004 S-33	400	48	44	32	055791	104,90



2850 Nástrčná hlavice pro rázový · strojový utahovák TORX®

Made in Germany

• Manipulace se šrouby hlav válců

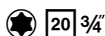

- Zesílené provedení
- Dlouhé provedení
- S otvorem pro pojistný kolík nebo zajišťovací pružinu a drážku pro O-kroužek
- Povrch: fosfátováno, olejováno
- DIN 3124, ISO 2725-2

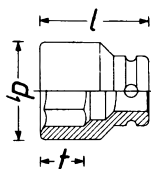

HAZET No.	l mm	d ₁ mm	d ₂ mm	mm	t mm	EAN-No. 4000896+	€
2850-E 20	110	25	44	18,49	15	079681	37,90
2850-E 24	110	30	44	22,16	17,5	146758	38,45

1003 Adaptér pro rázový · strojový utahovák

Made in Germany

• Manipulace s nástrčnými hlavicemi pro rázový a strojový utahovák 900 SZ 6 · 903 SZ 6 · 985 S · 990 S · 1003 S-07

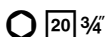

- □ Pohon 20 = 3/4" – ○ 24 mm
- Povrch: fosfátováno, olejováno



HAZET No.	EAN-No. 4000896+	€
1003 S-1	161034	23,50

Made in Germany

- S otvorem pro pojistný kolík nebo zajišťovací pružinu a drážku pro O-kroužek
- Povrch: fosfátováno, olejováno
- ● 24 mm – ■ pohon 12,5 = 1/2"



HAZET No.	l mm	EAN-No. 4000896+	€
1003 S-07	44	215409	15,50

1007 S Adaptér pro rázový · strojový utahovák

Made in Germany

- S otvorem pro pojistný kolík nebo zajišťovací pružinu a drážku pro O-kroužek
- Povrch: fosfátováno, olejováno



HAZET No.	l mm	EAN-No. 4000896+	€
• ■ Pohon 12,5 = 1/2" – □ pohon 20 = 3/4"			
1007 S-1	56	001804	33,65
• ■ Pohon 25 = 1" – □ pohon 20 = 3/4"			
1007 S-2	65	001828	39,30

1007 S Adaptér pro rázový · strojový utahovák

Made in Germany

• Výměnná zásuvná čepel ● 24 mm – ■ pohon 12,5 = 1/2"

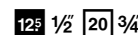

- S otvorem pro pojistný kolík nebo zajišťovací pružinu a drážku pro O-kroužek
- Povrch: fosfátováno, olejováno
- □ Pohon 20 = 3/4" – ■ pohon 12,5 = 1/2"



HAZET No.	EAN-No. 4000896+	€
1007 S-7/14	215416	42,65

1006 S Kloubový díl pro rázový · strojový utahovák

Made in Germany

- S kloubem – pro použití na těžko přístupných místech a pro obejití rušivých hran
- S otvorem pro pojistný kolík nebo zajišťovací pružinu a drážku pro O-kroužek
- Povrch: mořeno, olejováno

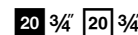

HAZET No.	l mm	EAN-No. 4000896+	€
1006 S	99	001781	90,25

1005 S Prodloužení pro rázový · strojový utahovák

Made in Germany

- S otvorem pro pojistný kolík nebo zajišťovací pružinu a drážku pro O-kroužek
- Povrch: fosfátováno, olejováno

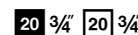

HAZET No.	l mm	EAN-No. 4000896+	€
1005 S- 7	175	001774	62,50
1005 S-13	330	001767	105,70

1000 S O-kroužek a spojovací kolík

Made in Germany

• Pro všechny spoje □ 20 = 3/4"



HAZET No.	mm	EAN-No. 4000896+	€
• O-kroužek a spojovací kolík			
1000 S-G 1736	∅ 36x5	001354	3,-
1000 S-H 1736	∅ 4x36	001361	0,75



Ruční nářadí

25 1" Program nástrčných klíčů



25 1" Program nástrčných klíčů

1100 Z Sada nástrčných klíčů (dvojitý 6hran)

Made in Germany

- S nástrčnými hlavice s dvojitým 6hranem
- Kovová schránka (modrá HAZET)

E ● 25 1"



1100 Z • ● • 25 1"
32 • 36 • 41 • 46 • 50 • 55
60 • 65 • 70 • 75 • 80



1115-1 • 25 1"



1117-8 • 25 1" • 25 1"



1117-16 • 25 1" • 25 1"



1114



1116 • 25 1"



1121 • 25 1" • 25 1"



HAZET No.	d x š x v mm		EAN-No. 4000896+	€
1100 Z	759x305x115	17	002504	1789,-

1116 Přepínací hlava ráčny

Made in Germany

- Počet zubů: 32
- Úhel ovládání: 11,25°
- Dřík s odjišťovacím čepem pro kolíkovou pojistku, výstup s kolíkovou pojistkou
- Povrch: chromováno
- DIN 3122, ISO 3315

E 25 1"



HAZET No.	l mm	EAN-No. 4000896+	€
1116	195	003198	218,10

Opotřeбенí? – Žádný problém!

- Nářadí HAZET je vyrobeno v nejvyšší kvalitě. Při dlouhém, intenzivním namáhání dochází i u vysoce kvalitních nástrojů k určitému opotřeбенí.
- Proto nabízíme pro mnoho našich nástrojů náhradní díly a sady náhradních dílů.

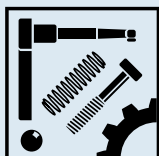

Nezapomeňte na náš obchod s náhradními díly www.hazet.de/ersatzteil-shop

Úspora nákladů – udržitelnost – šetří zdroje!
Abyste se mohli ze svého nářadí HAZET dlouho těšit

1116 Sada náhradních dílů

Made in Germany

- Počet zubů: 32
- Úhel ovládání: 11,25°



HAZET No.	EAN-No. 4000896+	€
1116/6	003228	5,-
1116/8 N	003235	65,90

Sada náhradních dílů ovládací páky obsah sady:
ovládací páka · šrouby · kulička · tlačná pružina
Pro přepínací ráčnu HAZET 1116
Pro momentové klíče HAZET 6150-1 CT · 6160-1 CT · 6170-1 CT · 7250-2 sTAC · 7250-5 sTAC

Sada náhradních dílů kolečka ráčny 25 = 1" ■, obsah sady:
ovládací páka · šrouby · kulička · tlačná pružina · fixační prvek · kolečko ráčny
Pro přepínací ráčnu HAZET 1116
Pro momentové klíče HAZET 6160-1 CT · 6170-1 CT

1116 Přepínací hlava ráčny s otočnou tyčí

Made in Germany

- Počet zubů: 32
- Úhel ovládání: 11,25°
- Dřík s odjišťovacím čepem pro kolíkovou pojistku, výstup s kolíkovou pojistkou
- Povrch: chromováno, leštěno
- DIN 3122

E 25 1"



HAZET No.	l mm		EAN-No. 4000896+	€
1116/2	824	2	003211	305,60

1115 Posuvný kus s otočnou tyčí

Made in Germany

- S kolíkovou pojistkou
- Povrch: chromováno, leštěno
- DIN 3122

25 1"



HAZET No.	l mm		EAN-No. 4000896+	€
1115/2	700	2	003181	126,70

1115 Posuvný kus

Made in Germany

- Pro otočnou tyč HAZET 1114
- S kolíkovou pojistkou
- Povrch: chromováno, leštěno
- DIN 3122

25 1"



HAZET No.	l mm	EAN-No. 4000896+	€
1115-1	80	003167	39,05



1114 Otočná tyč

Made in Germany

- Pro šoupátko HAZET 1115-1 nebo ráčnovou hlavu HAZET 1116
- Se zajištěním kuličkou a kolíkem
- Povrch: chromováno
- DIN 3122



HAZET No.	l mm	EAN-No. 4000896+	€
1114	700	003150	87,55

1100 Z Nástrčná hlavice · dvojitý šestihran

Made in Germany

- Krátké provedení
- S rýhováním
- S odjišťovacím čepem pro kolíkovou pojistku
- Povrch: chromováno, leštěno
- DIN 3124, ISO 2725-1

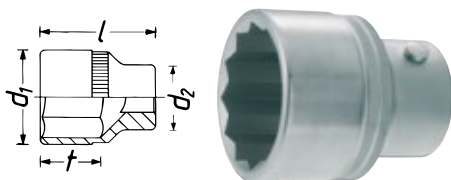

* = Mimo řady DIN

HAZET No.	l mm	d ₁ mm	d ₂ mm	t mm	EAN-No. 4000896+	€
1100 Z-32 *	60	48	46	22	002511	47,70
1100 Z-36 *	67	52	48	28,5	002528	49,30
1100 Z-41	68	57	48	29,5	002535	55,75
1100 Z-46	72	62	48	32	002542	61,40
1100 Z-50	74	68	48	35	002559	70,45
1100 Z-55	78	74	48	36,5	002566	83,55
1100 Z-60	83	80	48	40,5	002573	101,40
1100 Z-65	86	88	60	43,5	002580	126,20
1100 Z-70	89	96	60	46,5	002603	145,70
1100 Z-75	92	102	60	49,5	002610	184,10
1100 Z-80	94	108,5	60	52,5	002627	196,50

1158 Adaptér

Made in Germany

- Pohon s odjišťovacím čepem pro kolíkovou pojistku, výstup s kolíkovou pojistkou
- Povrch: chromováno
- DIN 3123, ISO 3316



HAZET No.	l mm	EAN-No. 4000896+	€
1158-2	70	003297	50,40

1121 Univerzální kloub

Made in Germany

- S kloubem – pro použití na těžko přístupných místech a pro obejít rušivých hran
- Pohon s odjišťovacím čepem pro kolíkovou pojistku, výstup s kolíkovou pojistkou
- Povrch: chromováno



HAZET No.	l mm	EAN-No. 4000896+	€
1121	144	003273	164,50

1117 Prodloužení

Made in Germany

- Pohon s odjišťovacím čepem pro kolíkovou pojistku, výstup s kolíkovou pojistkou
- Povrch: chromováno, leštěno
- DIN 3123, ISO 3316



HAZET No.	l mm	EAN-No. 4000896+	€
1117- 8	200	003259	71,55
1117-16	400	003242	99,35

1100 S Nástrčná hlavice pro rázový a strojový utahovák · šestihran

Made in Germany

- Pro extrémně vysoké zatížení
- Krátké provedení
- S otvorem pro pojistný kolík nebo zajišťovací pružinu a drážku pro O-kroužek
- Povrch: fosfátováno, olejováno
- DIN 3129, ISO 2725-2

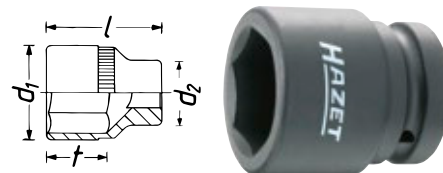

* = Mimo řady DIN

HAZET No.	l mm	d ₁ mm	d ₂ mm	t mm	EAN-No. 4000896+	€
1100 S-24	58	41,5	54	17	002207	52,05
1100 S-27	60	45	54	19	002214	52,05
1100 S-30	62	49	54	21	002221	52,40
1100 S-32	63	51,5	54	21	002238	52,40
1100 S-33 *	63	52,5	54	21	002252	52,40
1100 S-34	63	53,5	54	22	002269	53,20
1100 S-36	67	56,5	54	23	002276	55,55
1100 S-41	70	63	54	26	002290	70,65
1100 S-46	76	69,5	54	28	002320	79,15
1100 S-50	82	74,5	54	30	002344	104,50
1100 S-55	87	81	54	32	002351	113,30
1100 S-60	91	87	54	34	002375	138,20

1100 SLG Nástrčná hlavice pro rázový a strojový utahovák · šestihran

Made in Germany

- Dlouhé provedení
- S otvorem pro pojistný kolík nebo zajišťovací pružinu a drážku pro O-kroužek
- Povrch: fosfátováno, olejováno
- DIN 3129, ISO 2725-2



HAZET No.	l mm	d ₁ mm	d ₂ mm	t mm	EAN-No. 4000896+	€
1100 S Lg-24	110	41,5	54	17	002405	81,20
1100 S Lg-27	110	45	54	19	002412	84,95
1100 S Lg-30	110	49	54	21	002429	87,15
1100 S Lg-32	110	51,5	54	21	002436	88,35
1100 S Lg-33	110	52,5	54	21	002443	90,60
1100 S Lg-36	110	56,5	54	23	002467	90,60
1100 S Lg-38	110	59	54	24	002474	98,90
1100 S Lg-41	110	63	54	26	002481	108,20
1100 S Lg-46	110	69,5	54	28	002498	127,10



Ruční nářadí

25 1" Program nástrčných klíčů



1104 S Nástrčná hlavice pro rázový a strojový utahovák · šestihran

Made in Germany

- Např. pro hluboko položené kolové šrouby / matice na užitkových motorových vozidlech
- **Extra dlouhé provedení**
- S otvorem pro pojistný kolík nebo zajišťovací pružinu a drážku pro O-kroužek
- Povrch: fosfátováno, olejováno
- DIN 3129, ISO 2725-2

25 1"

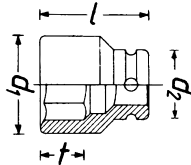

HAZET No.	l mm	d ₁ mm	d ₂ mm	f mm	EAN-No. 4000896+	€
1104 S-32	270	48,5	54	30,5	002665	113,-

1107 S Adaptér pro rázový · strojový utahovák

Made in Germany

- S otvorem pro pojistný kolík nebo zajišťovací pružinu a drážku pro O-kroužek
- Povrch: fosfátováno, olejováno

20 3/4" 25 1"



HAZET No.	l mm	EAN-No. 4000896+	€
1107 S	70	002733	71,50

1106 S Kloubový díl pro rázový · strojový utahovák

Made in Germany

- S kloubem – pro použití na těžko přístupných místech a pro obehnutí rušivých hran
- S otvorem pro pojistný kolík nebo zajišťovací pružinu a drážku pro O-kroužek
- Povrch: mořeno, olejováno

25 1" 25 1"



HAZET No.	l mm	EAN-No. 4000896+	€
1106 S	125	002719	135,90

1105 S Prodloužení pro rázový · strojový utahovák

Made in Germany

- S otvorem pro pojistný kolík nebo zajišťovací pružinu a drážku pro O-kroužek
- Povrch: fosfátováno, olejováno

25 1" 25 1"



HAZET No.	l mm	EAN-No. 4000896+	€
1105 S- 7	180	002702	95,15
1105 S-13	330	002696	120,80

1100 S O-kroužek a spojovací kolík

Made in Germany

- Pro všechna spojení □ 25 = 1"

25 1"



HAZET No.	mm	EAN-No. 4000896+	€
• O-kroužek a spojovací kolík			
1100 S-G 2260	∅ 45x7	002382	3,-
1100 S-H 2260	∅ 5x45	002399	0,75





Nářadí TORX®

1557 Sada šroubovacího nářadí TORX®

Made in Germany

• SmartCase (1/9) 165-S

• Safety-Insert-System, 2komponentní vložka z měkké pěny.

Vložka vhodná také pro HAZET-Assistent

ⓔ Ⓢ 6.3 1/4" 10 3/8" 12 1/2"



1/9				
-----	--	--	--	--



850 E • Ⓢ 1/4"
E 4 • E 5 • E 6

880 E • Ⓢ 3/8"
E 8 • E 10 • E 12

900 E • Ⓢ 1/2"
E 14 • E 18 • E 20

HAZET No.	d x š x v mm	Ⓢ	EAN-No. 4000896+	€
1557/9	185x153x52	9	003907	108,70

Made in Germany

• SmartCase (1/9) 165-S

• Safety-Insert-System, 2komponentní vložka z měkké pěny.

Vložka vhodná také pro HAZET-Assistent

• Povrch:

ⓔ Ⓢ 6.3 1/4" 10 3/8" 12 1/2"



1/9				
-----	--	--	--	--



8502 • Ⓢ 1/4"
T 8 • T 10 • T 15

8802 • Ⓢ 3/8"
T 20 • T 25 • T 30

992 • Ⓢ 1/2"
T 40 • T 50 • T 55 • T 60

HAZET No.	d x š x v mm	Ⓢ	EAN-No. 4000896+	€
1557/10	185x153x52	10	003716	155,-



1557 Sada šroubovacího nářadí TORX®

Made in Germany

• SmartCase (1/3) 165-L

• Safety-Insert-System, 2komponentní vložka z měkké pěny.

Vložka vhodná také pro HAZET-Assistent

• Povrch:

ⓔ Ⓢ 6.3 1/4" 10 3/8" 12 1/2"



1/3				
-----	--	--	--	--



880 E • Ⓢ 3/8"
E 5 • E 6 • E 7 • E 8
E 10 • E 11 • E 12 • E 14

8802 • Ⓢ 3/8"
T 15 • T 20 • T 25 • T 27
T 30 • T 40 • T 45 • T 50

8815 • Ⓢ 3/8"



8820 • Ⓢ 3/8" • Ⓢ 1/2"



8821 • Ⓢ 3/8" • Ⓢ 1/2"

8821-3 • 8821-6

8816 HP • Ⓢ 1/2"

HAZET No.	d x š x v mm	Ⓢ	EAN-No. 4000896+	€
1557/21	355x235x65	21	003822	326,20

• SmartCase (1/3) 165-L

• Safety-Insert-System, 2komponentní vložka z měkké pěny.

Vložka vhodná také pro HAZET-Assistent

ⓔ Ⓢ 6.3 1/4" 10 3/8" 12 1/2"



1/3				
-----	--	--	--	--



609 • Ⓢ
E 6, E 8 • E 10, E 12
E 14, E 18 • E 20, E 24

900 E • Ⓢ 1/2"
E 10 • E 12 • E 14

2223 • Ⓢ 1/4"
T 30 H

2223 LG • Ⓢ 1/4"
T 25

850 E • Ⓢ 1/4"
E 5 • E 6 • E 7 • E 8

992 • Ⓢ 1/2"
T 55 • T 60

2224 • Ⓢ 1/4"
T 40 • T 45 • T 50

880 E • Ⓢ 3/8"
E 10 • E 12 • E 14

2223 • Ⓢ 1/4"
T 10 • T 20 • T 25
T 27 • T 30

2250-1 • Ⓢ 1/4" • Ⓢ 3/8"
2250-3 • Ⓢ 1/4" • Ⓢ 3/8"
2250-5 • Ⓢ 1/4" • Ⓢ 1/2"

HAZET No.	d x š x v mm	Ⓢ	EAN-No. 4000896+	€
1557/29	355x235x65	29	003846	317,90



Ruční nářadí

Nářadí **TORX®**



1557 Sada šroubovacího nářadí **TORX®**

- Dvojitá výbava bitů
- SmartCase (1/9) 165-S
- Safety-Insert-System, 2komponentní vložka z měkké pěny. Vložka vhodná také pro HAZET-Assistent



2223 • • $\frac{1}{4}$
T 6 • T 7 • T 8 • T 9
T 10 • T 15 • T 20 • T 25
T 27 • T 30

2224 • • $\frac{1}{4}$
T 40 • T 45 • T 50 • T 55

2250-1 • • $\frac{1}{4}$
2250-2 • • $\frac{3}{8}$
2250-3 • • $\frac{3}{8}$
2250-5 • • $\frac{1}{2}$

HAZET No.	d x š x v mm		EAN-No. 4000896+	€
1557/32	185x153x52	32	003860	211,-

- SmartCase (1/3) 165-L
- Safety-Insert-System, 2komponentní vložka z měkké pěny. Vložka vhodná také pro HAZET-Assistent



609 •
E 6, E 8 • E 10, E 12
E 14, E 18 • E 20, E 24

8802 • • $\frac{1}{2}$
T 40 • T 45

2223 • • $\frac{1}{4}$
T 6

803-T •
T 6 • T 7 • T 8 • T 9
T 10 • T 15 • T 20 • T 25
T 27 • T 30

900 E • • $\frac{1}{2}$
E 16 • E 18 • E 20 • E 24

2223 • • $\frac{1}{4}$
T 7 H • T 8 H • T 9 H
T 10 H • T 15 H • T 20 H
T 25 H • T 27 H • T 30 H
T 40 H

850 E • • $\frac{1}{4}$
E 4 • E 5 • E 6 • E 7 • E 8

992 • • $\frac{1}{2}$
T 50 • T 55 • T 60

2223 LG • • $\frac{1}{4}$
T 25

880 E • • $\frac{1}{2}$
E 10 • E 11 • E 12 • E 14
2115 •
T 6 • T 7 • T 8 • T 9
T 10 • T 15 • T 20 • T 25
T 27 • T 30 • T 40

2250-1 • • $\frac{1}{4}$
2250-2 • • $\frac{1}{2}$

863 HP B • $\frac{1}{4}$

HAZET No.	d x š x v mm		EAN-No. 4000896+	€
1557/58	355x235x65	58	003884	608,-

163 Sada nářadí • **TORX®**

• **Made in Germany**

- Safety-Insert-System, 2komponentní vložka z měkké pěny. Vložka vhodná také pro HAZET-Assistent
- Povrch:

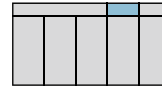

850 E • • $\frac{1}{4}$
E 4 • E 5 • E 6 • E 7
E 8 • E 10 • E 11

8502 • • $\frac{1}{4}$
T 10 • T 15 • T 20 • T 25
T 27 • T 30 • T 40

HAZET No.	d x š mm		EAN-No. 4000896+	€
163-251/14	172x50	14	178063	88,40

• **Made in Germany**

- Safety-Insert-System, 2komponentní vložka z měkké pěny. Vložka vhodná také pro HAZET-Assistent
- Povrch:

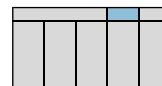

880 E • • $\frac{3}{8}$
E 8 • E 10 • E 12 • E 14

8802 • • $\frac{3}{8}$
T 25 • T 30 • T 40
T 45 • T 50

HAZET No.	d x š mm		EAN-No. 4000896+	€
163-252/9	172x50	9	178070	86,35

• **Made in Germany**

- Safety-Insert-System, 2komponentní vložka z měkké pěny. Vložka vhodná také pro HAZET-Assistent

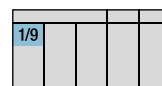

900 E • • $\frac{1}{2}$
E 10 • E 12 • E 14
E 16 • E 18 • E 20

992 • • $\frac{1}{2}$
T 30 • T 40 • T 45
T 50 • T 55 • T 60

HAZET No.	d x š mm		EAN-No. 4000896+	€
163-245/12	172x114	12	178049	123,30





Šroubováky/bity



Šroubováky HEXAnamic® s 3komponentní rukojetí [802]	⊖ ⊕ * * *	182–183
Šroubováky s 2komponentní rukojetí, krátký tvar [801 N K]	⊖ ⊕	183
Šroubováky s úderovou hlavicí, s 3komponentní rukojetí [810 U]	⊖ ⊕	183–184
Šroubováky s 3komponentní rukojetí [810]	⊖ ⊕ *	184–185
Šroubováky trinamic® s jednokomponentní rukojetí [803]	⊖ ⊕ * * *	185–186
Šroubovák s ochrannou izolací, 2komponentní rukojeť [810]	⊖ ⊕ *	247–248
Šroubováky na elektroniku [805]	⊖ ⊕ *	187
Nástrčné klíče [426/428]	⦿	187–188
Šroubováky s 2komponentní T-rukojetí [828]	○ *	188–189
Úhlové šroubováky [819/2100–2116]	⊕ ○ *	190–191
6.3 1/4 Sady bitů [863/2200/2240]	⊖ ⊕ * ○ * *	193
6.3 1/4 Bity [2208–2225]	⊖ ⊕ * ○ * * *	194–195
6.3 1/4 Ovládací nářadí a spojovací díly pro bity [810 / 863 / 2264 – 2265]		195–196
8 5/16 Sady bitů [2272]	⊖ ⊕ ○ *	197
8 5/16 Bity [2210–2212]	⊖ ⊕ * ○ * *	197
8 5/16 Ovládací nářadí a spojovací díly pro bity [2250 – 2272]		198



Ruční nářadí

Šroubováky/bity



Šroubovák HAZET HEXAnamic® 802

Anatomicky tvarovaný šroubovák v souladu s nejnovějšími ergonomickými poznatky

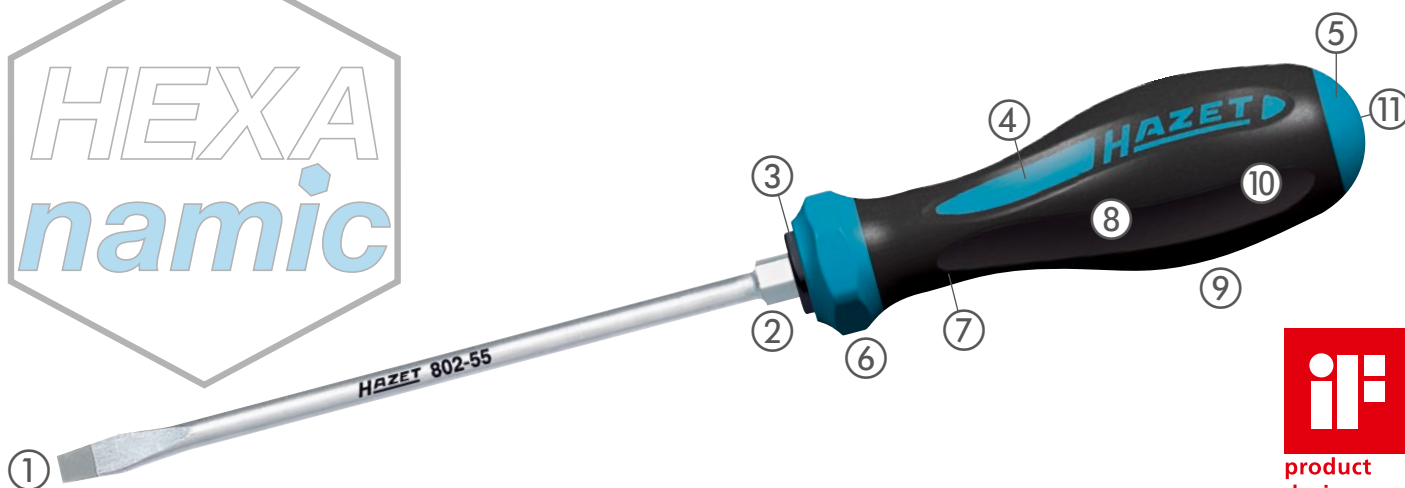

product design award

2009

- ① Hroty s šedou povrchovou úpravou pro **optimální ochranu proti korozi** a **perfektní stabilitu** čepele v hlavě šroubu
- ② **Integrovaný 6hranný nástavec** Jako pomůcka klíče pro přenos vyšších utahovacích momentů
- ③ **Komponent 1 (tvrdý):** optimální fixace čepele
- ④ **Komponenta 3 (měkká):** Pro charakteristickou ochranu proti skluzu při axiálním tlaku
- ⑤ **Komponenta 2 (tvrdá):** Stabilita před vnějšími nárazy
- ⑥ **Přesazený 6hran** v přední oblasti rukojeti:
 - **Optimalizovaná ochrana před sklouznutím**
 - Proti **nekontrolovanému sesmeknutí** šroubováku
- ⑦ **Rychloběžná zóna** s optimalizovanou velikostí
- ⑧ **Neklouže** ani v rukách potřísněných olejem
- ⑨ Ergonomický tvar pro vytvoření **perfektního kontaktu** mezi rukou a šroubovákem
- ⑩ **6 prohloubených úchopových zón** pro optimální přenos síly
- ⑪ **Natištěný profil šroubu** pro rychlé vyhledání správného šroubováku – kdykoliv!

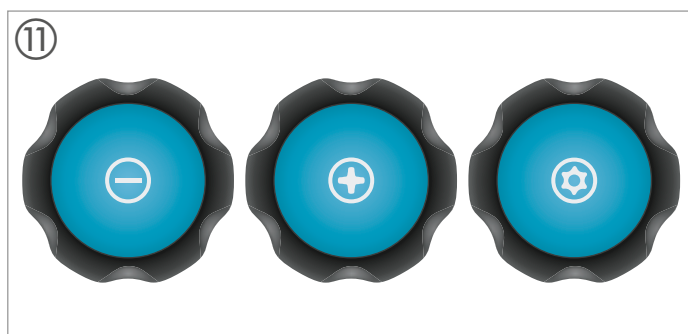
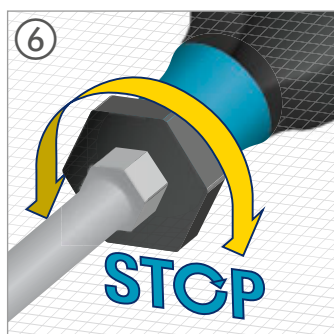
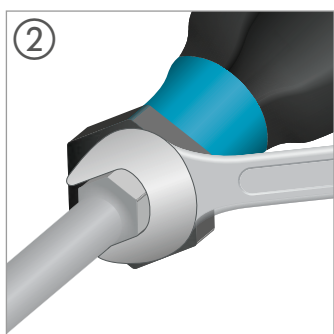



Design rukojeti HAZET 802

Optimálně přizpůsobený velikostem šroubů

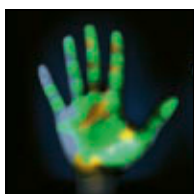
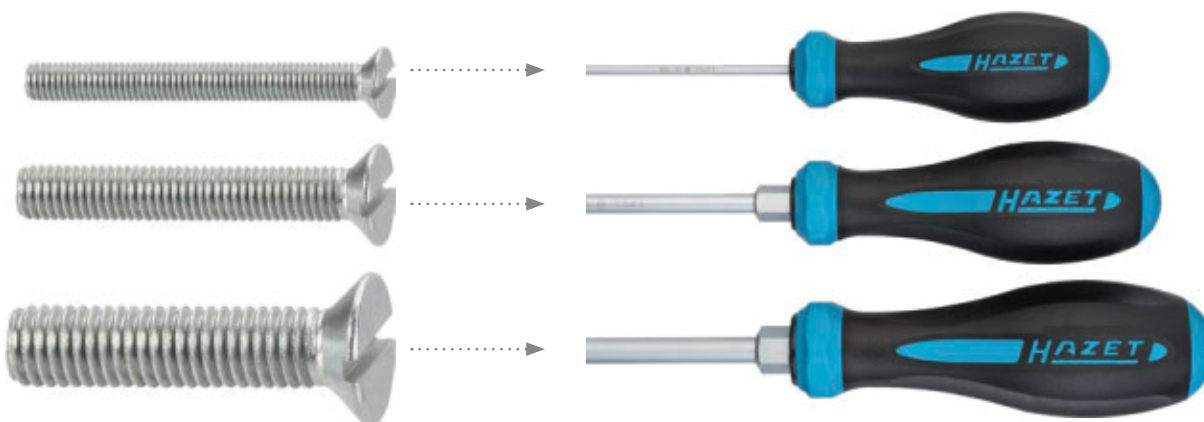

Rukojeť HEXAnamic®
= nízké zatížení



Běžná rukojeť
= vysoké zatížení

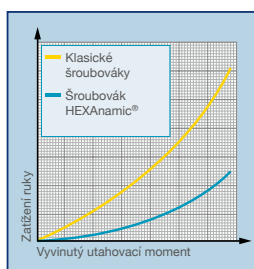

RYCHLÉ



Designové prvky HAZET pro rychlé otáčení

- Velikostně optimalizovaná štíhlá zóna pro rychlé otáčení na začátku rukojeti zajišťuje rychlé otáčení
- Optimální pro rychlé a citlivé šroubové spojení



SILNÉ



Designové prvky HAZET pro výkonnou práci při šroubování

- 6 hlubších, na dotek příjemných úchopových zón pro optimální přenos sil
- Ergonomicky tvarovaná rukojeť pro vytvoření perfektního kontaktu mezi rukou a šroubovákem
- Díky uživatelsky příjemnému tvaru se dobře hodí i pro dlouhodobé používání
- Výrazná ochrana proti sklouznutí pro bezpečnou práci a vysoký uťahovací moment při axiálním přtlaku

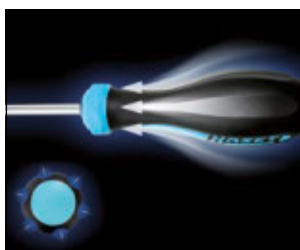



Ruční nářadí

Šroubováky/bity



Šroubovák HAZET 810

Nový ekonomicky výhodný šroubovák

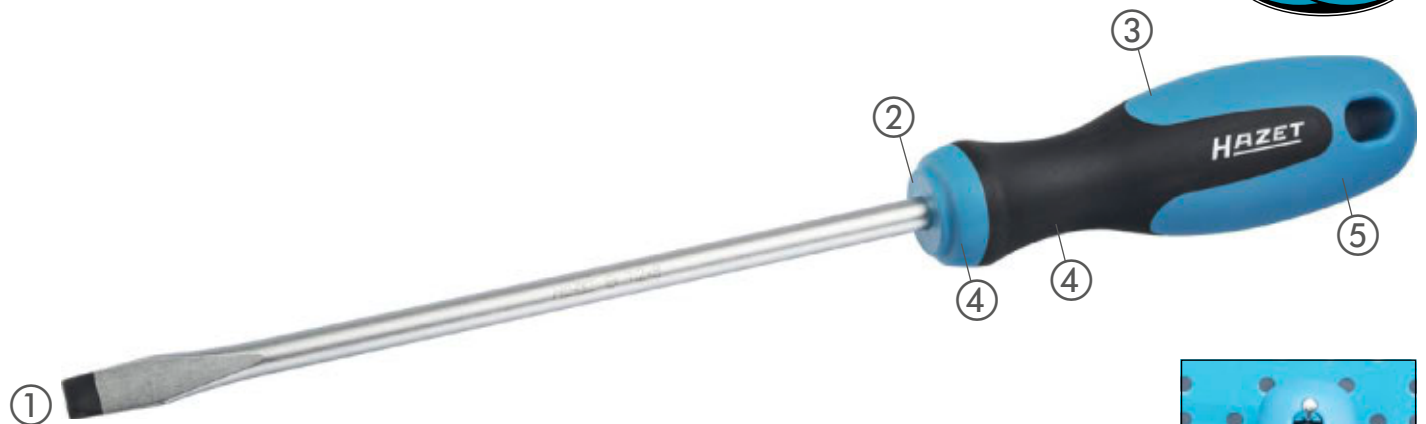

① Černě natřená špička pro **optimální ochranu proti korozi** a **perfektní držení** čepule v hlavě šroubu

② • **Optimalizovaná ochrana před sklouznutím**
• Proti **nekontrolovanému sesmeknutí** šroubováku



③ **3komponentní rukojeť** HAZET zajišťuje vždy optimální výkon a uchopení. Měkčí, neklouzavé složky umožňují stabilní držení. Výrazné skluzové zóny zajišťují sílu díky perfektnímu silovému záběru.

④ Tvrdá komponenta

⑤ Měkká komponenta





Šroubovák HAZET 810 U s úderovou hlavicí

Nejen ke „šroubování“!

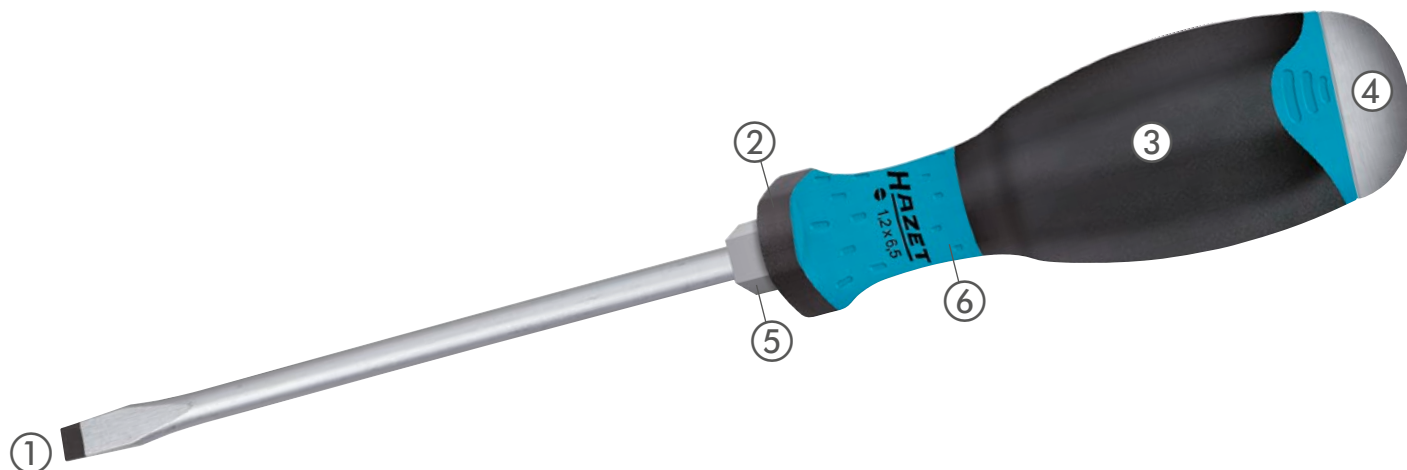

① Černě natřená špička pro **optimální ochranu proti korozi a perfektní držení** čepule v hlavě šroubu

② • **Optimalizovaná ochrana před sklouznutím**
• Proti **nekontrolovanému sesmeknutí** šroubováku



③ **3komponentní rukojeť** HAZET zajišťuje vždy optimální výkon a uchopení. Měkčí, neklouzavé složky umožňují stabilní držení. Výrazné skluzové zóny zajišťují sílu díky perfektnímu silovému záběru.



④ **Integrovaná ocelová krytka** zvyšuje životnost rukojeti a snižuje nebezpečí rozštěpení. K uvolnění zaseknutých šroubů nebo provedení drobnějšího sekání
Poznámka: Z bezpečnostních důvodů vždy nosit ochranné brýle!

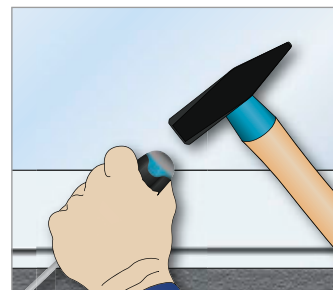

⑤ Šestihranný nástavec pro přenos vyšších točivých momentů pomocí šroubového klíče.

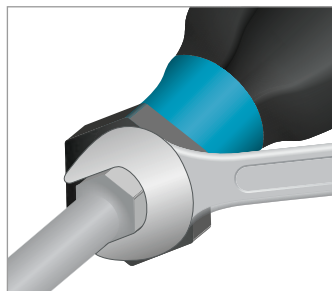

⑥ Pro ergonomicky tvarovanou rukojeť, která vytváří perfektní kontakt mezi rukou a šroubovákem, se dobře hodí pro trvalé používání.





Ruční nářadí

Šroubováky/bity



Šroubovák trinamic® HAZET 803

Syntéza oceli a plastu



① Černě natřená špička pro **optimální ochranu proti korozi** a **perfektní držení** čepel v hlavě šroubu

② Tvar trinamic® :
• **Optimalizovaná ochrana před sklouznutím**
• Proti **nekontrolovanému sesmeknutí** šroubováku



③ **Neklouže** ani v rukách potřísněných olejem

④ **Napěchovaný a stlačený 6hranný nástavec** několikanásobně vyšší přenos sil při použití plochého klíče

⑤ Úzký tvar se zónou rychlého otáčení

⑥ trinamic®
Jednokomponentní rukojeť, ergonomická a vysoce zatížitelná





Různá provedení rukojeti HAZET

RYCHLÉ

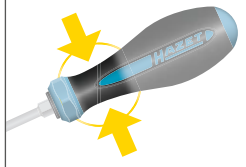

Rychloběžná zóna s optimalizovanou velikostí

- Umožňuje bezpečné a rychlé otáčení mezi palcem a ukazovákem
- Optimální vedení díly mírnému rozšíření směrem k přesazenému šestihranu jako ochrana proti sklouznutí
- Ergonomický tvar rukojeti pro dokonalý silový záběr u všech komponentů

SILNÉ



3komponentní rukojeť HAZET pro perfektní silový záběr

- Maximální silový záběr díky ergonomické 3komponentní rukojeti
- Rukojeť lze sevřít celou pěstí a silně „uchopit“
- Vhodná pro dlouhodobé používání, protože díky vysoké ergonomii neobsahuje žádné prvky, které by způsobovaly bolesti při utahování šroubů



Šroubováky s 2komponentní rukojetí, krátké provedení



HEXAnamic® s 3komponentní rukojetí



Šroubováky s úderovou hlavicí, s 3komponentní rukojetí



Šroubováky s 3komponentní rukojetí



Šroubováky trinamic® s jednokomponentní rukojetí



Elektronický šroubovák



Šroubovák se svorkou



Věděli jste to?

Vysoký výkon a trvanlivost

- Čepel je průběžně kalená z nejlepších chrom-vanadových molybdenových ocelí
- **Precizní uložení v hlavě šroubu**
- Vysoce přesný hrot čepele, dodatečně brunovaný
- Trvalá ochrana před korozí
- Chromovaný povrch poskytuje perfektní ochranu před rží
- **Rychlé nalezení správného šroubováku**
- Natištěný profil šroubu usnadňuje mechanikovi vždy správný výběr nástroje
- **Ideální pro dlouhodobé používání**
- Ergonomický tvar rukojeti zabraňuje otlakům a bolestivým otokům

Další výhoda s ohledem na bezpečnost práce

- Přesazená šestihranná ochrana proti odvalení zabraňuje nežádoucímu sesmeknutí a navíc poskytuje ochranu proti sklouznutí pro bezpečnou práci

3komponentní rukojeť HAZET zajišťuje svou kombinací materiálů optimální výkon a uchopení

- Neklouzavé složky umožňují stabilní držení a výrazné skluzové zóny dodávají sílu díky perfektnímu silovému záběru

Společnost HAZET nabízí pro šroubováky s drážkou následující specifické čepele:

- Klínovitá špička čepele pro dílenské použití → vhodná pro šroubování
- Podle ISO 2380-1:2004, ISO 2380-2:2004

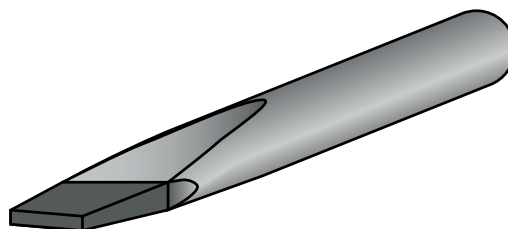

- Úzká paralelní špička čepele pro elektrikářské použití → vhodná pro všechny hluboko uložené šrouby v šachtě na šroub, např. v zásuvkách nebo svítidlové svorkovnici
- Podle ISO 2380-1; 2004, tvar B

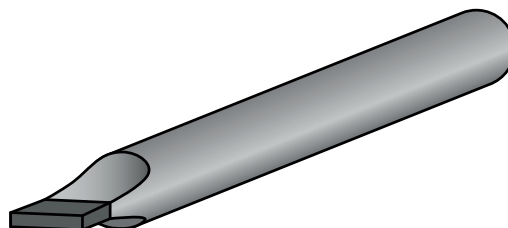



802 Šroubovák HEXAnamic®

- Kulatá čepel
- Neklouzavá 3komponentní rukojeť HAZET – pro vysoký přenos síly
- Povrch: chromováno
- ISO 2380-1:2004, ISO 2380-2:2004

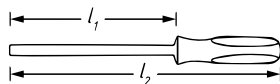

Břit od velikosti 55 s šestihránným bitem jako pomocný klíč pro zavedení vysokých povolovacích sil

HAZET No.	l_1 mm	l_2 mm	mm	mm	b mm	EAN-No. 4000896+	€
802- 30	80	179	–	0,6	3,5	144785	5,90
802- 40	100	199	–	0,8	4	144808	6,75
802- 55	125	239	8	1	5,5	144815	11,70
802- 65	150	264	10	1,2	6,5	144822	12,90
802- 80	150	279	13	1,2	8	144839	16,75
802-100	175	304	13	1,6	10	144846	20,10
802-120	200	329	16	2	12	144853	24,10

802-PH Šroubovák HEXAnamic®

- Kulatá čepel
- Neklouzavá 3komponentní rukojeť HAZET – pro vysoký přenos síly
- ISO 8764-1:2004, ISO 8764-2:2004

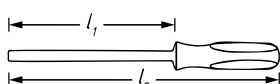

Velikost břítu PH 3 s 6hranným bitem

HAZET No.	l_1 mm	l_2 mm	mm	EAN-No. 4000896+	€
802-PH 0	60	159	–	144860	6,70
802-PH 1	80	194	–	144884	7,75
802-PH 2	100	214	–	144907	10,70
802-PH 3	150	279	13	144921	17,95

802-PZ Šroubovák HEXAnamic®

- Kulatá čepel
- Neklouzavá 3komponentní rukojeť HAZET – pro vysoký přenos síly
- ISO 8764-1:2004, ISO 8764-2:2004

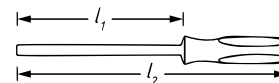

Velikost břítu PZ 3 s 6hranným bitem

HAZET No.	l_1 mm	l_2 mm	mm	EAN-No. 4000896+	€
802-PZ 0	60	159	–	145058	7,55
802-PZ 1	80	194	–	145065	8,90
802-PZ 2	100	214	–	145072	12,50
802-PZ 3	150	279	13	145089	21,85

802-TH Šroubováky HEXAnamic®

- Kulatá čepel
- Neklouzavá 3komponentní rukojeť HAZET – pro vysoký přenos síly

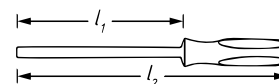

HAZET No.	l_1 mm	l_2 mm	mm	EAN-No. 4000896+	€
802-T 8 H	60	159	2,31	145102	10,85
802-T 9 H	60	159	2,50	145119	10,85
802-T 10 H	80	179	2,74	145126	10,85
802-T 15 H	80	179	3,27	145133	11,35
802-T 20 H	100	214	3,86	145140	11,35
802-T 25 H	100	214	4,43	145164	11,60
802-T 27 H	115	214	4,99	145171	11,85
802-T 30 H	115	229	5,52	145188	12,50
802-T 40 H	130	259	6,65	145195	13,80
802-T 45 H	130	259	7,82	145201	16,85

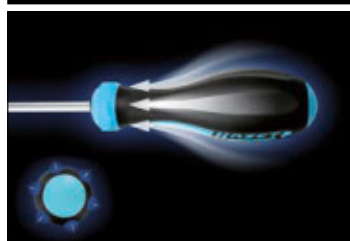



Ruční nářadí

Šroubováky/bity



801 NK Šroubováky

- Krátké provedení
- Kulatá čepel
- Ergonomická 2komponentní rukojeť HAZET

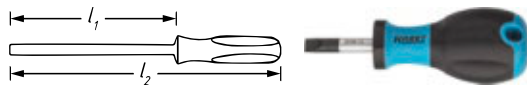

HAZET No.	l_1 mm	l_2 mm	$\frac{b}{d}$ mm	b mm	EAN-No. 4000896+	€
801 N K-35	25	89	0,6	3,5	209897	8,80
801 N K-55	25	89	1	5,5	209873	10,20
801 N K-80	25	89	1,2	8	209903	10,45

801 NK-PH Šroubováky

- Krátké provedení
- Kulatá čepel
- Ergonomická 2komponentní rukojeť HAZET

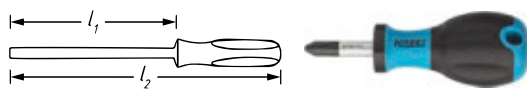

HAZET No.	l_1 mm	l_2 mm	EAN-No. 4000896+	€
801 N K-PH 1	25	89	209910	8,55
801 N K-PH 2	25	89	209880	8,95

802 Sada šroubováků HEXAnamic®

- Neklouzavá 3komponentní rukojeť HAZET – pro vysoký přenos síly
- Povrch: chromováno

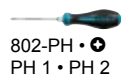
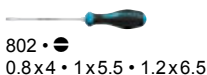

HAZET No.	$d \times \check{s}$ mm	EAN-No. 4000896+	€
802/5	5	147359	41,05

- Neklouzavá 3komponentní rukojeť HAZET – pro vysoký přenos síly

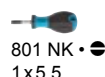
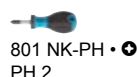
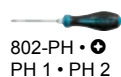
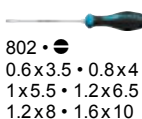

HAZET No.	l_1 mm	l_2 mm	$\frac{b}{d}$ mm	b mm	EAN-No. 4000896+	€
802/10	10	145577	110,70			

802 Sada šroubováků HEXAnamic®

- Safety-Insert-System, 2komponentní vložka z měkké pěny. Vložka vhodná také pro HAZET-Assistent
- Neklouzavá 3komponentní rukojeť HAZET – pro vysoký přenos síly

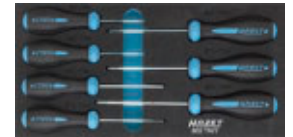

802-TH • \oplus
T 8 H • T 9 H • T 10 H • T 15 H • T 20 H • T 25 H • T 30 H

HAZET No.	$d \times \check{s}$ mm	$\frac{b}{d}$ mm	EAN-No. 4000896+	€
802 T H/7	342x172	7	145607	82,05

- Safety-Insert-System, 2komponentní vložka z měkké pěny. Vložka vhodná také pro HAZET-Assistent

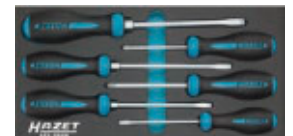
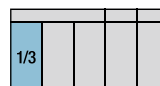

802 • \ominus
0.8x4 • 1x5.5 • 1.2x6.5 • 1.2x8



802-PH • \oplus
PH 1 • PH 2

HAZET No.	$d \times \check{s}$ mm	$\frac{b}{d}$ mm	EAN-No. 4000896+	€
163-184/6	342x172	6	161461	66,80

802 TH Sada šroubováků HEXAnamic®

- Safety-Insert-System, 2komponentní vložka z měkké pěny. Vložka vhodná také pro HAZET-Assistent

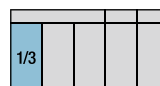

802-TH • \oplus
T 10 H • T 15 H • T 20 H
T 25 H • T 30 H

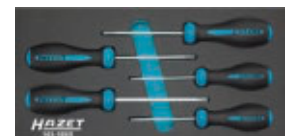

HAZET No.	$d \times \check{s}$ mm	$\frac{b}{d}$ mm	EAN-No. 4000896+	€
163-185/5	342x172	5	161478	64,75

810 U Šroubovák s úderovou hlavicí

- Břit s 6hranným bitem jako pomocný klíč pro zavedení vysokých povolovacích sil

- Kulatá čepel
- Neklouzavá 3komponentní rukojeť HAZET – pro vysoký přenos síly
- Povrch: čepel matný chrom, špička mořená



HAZET No.	l_1 mm	l_2 mm	$\frac{b}{d}$ mm	b mm	EAN-No. 4000896+	€	
810 U-45	75	175	8	0,8	4,5	200504	11,90
810 U-55	100	200	8	1	5,5	200511	13,10
810 U-70	125	225	10	1,2	7	200528	17,70



810 U-PH Šroubovák s úderovou hlaví

- Břit s 6hranným bitem jako pomocný klíč pro zavedení vysokých povolovacích sil



- Kulatá čepel
- Neklouzavá 3komponentní rukojeť HAZET – pro vysoký přenos síly
- Povrch: čepel matný chrom, špička mořená



HAZET No.	l_1 mm	l_2 mm	mm	EAN-No. 4000896+	€
810 U-PH 1	80	180	8	200498	13,15
810 U-PH 2	100	210	10	200481	15,40
810 U-PH 3	150	260	13	200474	17,70

810 U Sada šroubováků s úderovou hlavou

- Břit s 6hranným bitem jako pomocný klíč pro zavedení vysokých povolovacích sil



- Kulatá čepel
- Neklouzavá 3komponentní rukojeť HAZET – pro vysoký přenos síly
- Povrch: čepel matný chrom, špička mořená



810 U •
 0.8x4.5 • 1x5.5 • 1.2x7

810 U-PH •
 PH 1 • PH 2

HAZET No.		EAN-No. 4000896+	€
810 U-1/5	5	179572	39,05

- Břit s 6hranným bitem jako pomocný klíč pro zavedení vysokých povolovacích sil



- Kulatá čepel
- Safety-Insert-System, 2komponentní vložka z měkké pěny. Vložka vhodná také pro HAZET-Assistent
- Neklouzavá 3komponentní rukojeť HAZET – pro vysoký přenos síly

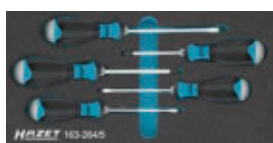

810 U •
 0.8x4.5 • 1x5.5 • 1.2x7

810 U-PH •
 PH 1 • PH 2

HAZET No.	$d \times \check{s}$ mm		EAN-No. 4000896+	€
163-264/5	342x172	5	180592	50,35

810 U Sada šroubováků

- Kulatá čepel
- Safety-Insert-System, 2komponentní vložka z měkké pěny. Vložka vhodná také pro HAZET-Assistent



- Neklouzavá 3komponentní rukojeť HAZET – pro vysoký přenos síly
- Hodí se pro HAZET *Assistent* s hloubkou zásuvky 398 mm:
173 • 179 • 179 N • 179 W • 179 N W • 179 BIG-1 • 179 XL • 179 N XL • 179 XXL • 179 N XXL • 179 A XXL • 179 T XXL • 180

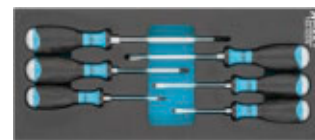
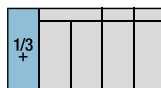

810 U •
 0.8x4.5 • 1x5.5 • 1.2x7

810 U-PH •
 PH 1 • PH 2 • PH 3

HAZET No.	$d \times \check{s}$ mm		EAN-No. 4000896+	€
163-522/6	392x172	6	218660	91,45

810 Šroubováky

- Otvor pro zavěšení v rukojeti



- Kulatá čepel
- Neklouzavá 3komponentní rukojeť HAZET – pro vysoký přenos síly
- Povrch: čepel matný chrom, špička mořená



HAZET No.	l_1 mm	l_2 mm	$\frac{b}{d}$ mm	b mm	EAN-No. 4000896+	€
810-25	75	160	0,4	2,5	206919	4,45
810-30	80	165	0,5	3	205127	5,-
810-40	100	185	0,8	4	205134	5,35
810-55	125	230	1	5,5	205141	5,95
810-65	150	265	1,2	6,5	205158	6,70

810-PH Šroubováky

- Otvor pro zavěšení v rukojeti



- Kulatá čepel
- Neklouzavá 3komponentní rukojeť HAZET – pro vysoký přenos síly
- Povrch: čepel matný chrom, špička mořená



HAZET No.	l_1 mm	l_2 mm	EAN-No. 4000896+	€
810-PH 0	60	145	206926	5,15
810-PH 1	80	185	205165	5,70
810-PH 2	100	215	205172	6,30

810-PZ Šroubováky

- Otvor pro zavěšení v rukojeti



- Kulatá čepel
- Neklouzavá 3komponentní rukojeť HAZET – pro vysoký přenos síly
- Povrch: čepel matný chrom, špička mořená

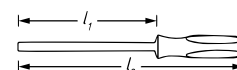

HAZET No.	l_1 mm	l_2 mm	EAN-No. 4000896+	€
810-PZ 1	80	185	221813	7,10
810-PZ 2	100	215	221806	7,65



Ruční nářadí

Šroubováky/bity



810-T Šroubováky

- Otvor pro zavěšení v rukojeti



- Kulatá čepel
- Neklouzává 3komponentní rukojeť HAZET – pro vysoký přenos síly
- Povrch: čepel matný chrom, špička mořená



HAZET No.	l_1 mm	l_2 mm	mm	EAN-No. 4000896+	€
810-T 10	80	165	2,74	205189	6,70
810-T 15	80	165	3,27	205196	6,75
810-T 20	100	185	3,86	205202	6,80
810-T 25	100	205	4,43	205219	7,15
810-T 27	115	220	4,99	205226	8,35
810-T 30	115	230	5,52	205233	8,80

810 Sada šroubováků

- Otvor pro zavěšení v rukojeti



- Neklouzává 3komponentní rukojeť HAZET – pro vysoký přenos síly
- Povrch: čepel matný chrom, špička mořená



YouTube Clip



810 • 0.5x3 • 0.8x4 • 1x5.5 • 1.2x6.5



810-PH • PH 1 • PH 2

HAZET No.	mm	EAN-No. 4000896+	€
810/6	6	058808	23,80

810 PZ Sada šroubováků

- Otvor pro zavěšení v rukojeti



- Neklouzává 3komponentní rukojeť HAZET – pro vysoký přenos síly
- Povrch: čepel matný chrom, špička mořená



810 • 0.5x3 • 0.8x4 • 1x5.5 • 1.2x6.5



810-PZ • PZ 1 • PZ 2

HAZET No.	mm	EAN-No. 4000896+	€
810/6 PZ	6	217984	23,80

810 T Sada šroubováků

- Otvor pro zavěšení v rukojeti



- Neklouzává 3komponentní rukojeť HAZET – pro vysoký přenos síly
- Povrch: čepel matný chrom, špička mořená



YouTube Clip



810-T • T 10 • T 15 • T 20 • T 25 • T 27 • T 30

HAZET No.	mm	EAN-No. 4000896+	€
810 T/6	6	204304	35,55

810 TSPC Sada šroubováků TORX®

- Safety-Insert-System, 2komponentní vložka z měkké pěny. Vložka vhodná také pro HAZET-Assistent

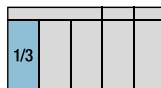

810-T • T 10 • T 15 • T 20 • T 25 • T 27 • T 30



HAZET No.	$d \times \check{s}$ mm	l mm	b mm	mm	EAN-No. 4000896+	€
163-266/6	342x172	342	172	6	180615	30,75

803 Šroubovák trinamic®

- Kulatá čepel
- Ergonomická 1komponentní rukojeť trinamic
- Povrch: chromováno, špička mořená
- ISO 2380-2

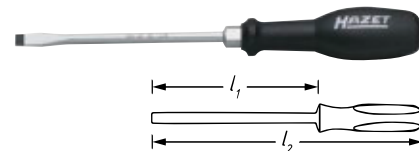

* = s 6hranným nástavcem jako pomůcka ke klíči pro zajištění vyšších uvolňovacích sil
+ = údaj l1 mimo ISO 2380-2

HAZET No.	l_1 mm	l_2 mm	mm	mm	b mm	EAN-No. 4000896+	€
803- 20 +	63	143	-	0,4	2	077434	3,90
803- 25	75	155	-	0,4	2,5	077441	3,90
803- 30 +	80	160	-	0,5	3	077458	4,60
803- 35	100	193	-	0,6	3,5	077465	5,60
803- 40	100	193	-	0,8	4	077472	6,20
803- 55	125	218	-	1	5,5	077489	7,65
803 S-55 *	125	235	8	1	5,5	089109	10,20
803- 65	150	260	-	1,2	6,5	077496	9,30
803- 80 *	150	272	13	1,2	8	077502	15,45
803-100 *	175	309	13	1,6	10	077519	18,55
803-120 *	200	334	16	2	12	077526	22,55
803-140 *	250	384	16	2,5	14	077533	28,10



803 LG Šroubovák trinamic®

- Pro nízko uložená šroubení
- Extra dlouhé provedení
- Kulatá čepel
- Ergonomická 1komponentní rukojeť trinamic



HAZET No.	l_1 mm	l_2 mm	$\frac{b}{d}$ mm	b mm	EAN-No. 4000896+	€
803 Lg-55	410	520	1	5,5	077540	25,65

803-PH Šroubovák trinamic®

- Kulatá čepel
- Ergonomická 1komponentní rukojeť trinamic
- DIN ISO 8764-2, ISO 8764-2

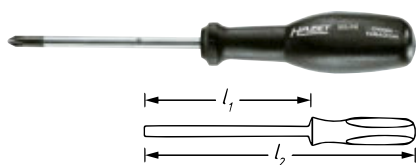

Od velikosti bítu PZ 3 s 6hranným bitem

HAZET No.	l_1 mm	l_2 mm	mm	EAN-No. 4000896+	€
803-PH 0	60	140	-	077557	6,20
803-PH 1	80	173	-	077564	7,05
803-PH 2	100	210	-	077571	9,25
803-PH 3	150	272	13	077588	15,90
803-PH 4	200	334	16	077595	21,80

803 LG-PH Šroubovák trinamic®

- Extra dlouhé provedení
- Kulatá čepel
- Ergonomická 1komponentní rukojeť trinamic



HAZET No.	l_1 mm	l_2 mm	EAN-No. 4000896+	€
803 Lg-PH 1	250	343	077601	18,75
803 Lg-PH 2	250	360	077618	27,25

803-PZ Šroubovák trinamic®

- Kódovací kroužek modrý
- Kulatá čepel
- Ergonomická 1komponentní rukojeť trinamic

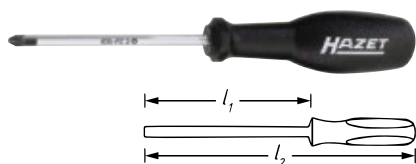

HAZET No.	l_1 mm	l_2 mm	EAN-No. 4000896+	€
803-PZ 1	80	173	077632	8,-
803-PZ 2	100	210	077649	11,50

803-T Šroubovák trinamic®

Made in Germany

- Kulatá čepel
- Ergonomická 1komponentní rukojeť trinamic

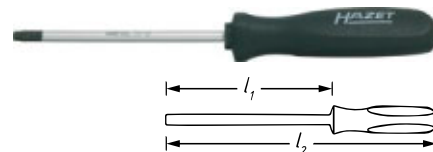

HAZET No.	l_1 mm	l_2 mm	mm	EAN-No. 4000896+	€
803-T 6	48	112	1,67	077670	6,95
803-T 7	48	112	1,99	077687	6,95
803-T 8	55	127	2,31	077694	6,95
803-T 9	55	127	2,50	077700	7,20
803-T 10	70	150	2,74	077717	7,55
803-T 15	70	150	3,27	077724	7,55
803-T 20	84	175	3,86	077731	7,55
803-T 25	84	175	4,43	077748	8,80
803-T 27	99	200	4,99	077755	8,80
803-T 30	99	200	5,52	077762	9,25
803-T 40	99	217	6,65	086214	11,70

803 LG-T Šroubovák trinamic®

- Použití např. v oblasti palubní desky, karoserie, motoru a průmyslových aplikací
- Dlouhé provedení
- Kulatá čepel
- Ergonomická 1komponentní rukojeť trinamic

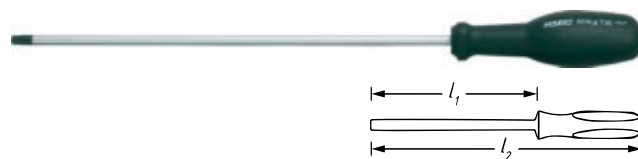

HAZET No.	l_1 mm	l_2 mm	mm	EAN-No. 4000896+	€
803 Lg-T 15	250	330	3,27	087785	12,25
803 Lg-T 20	250	343	3,86	087792	12,25
803 Lg-T 25	250	345	4,43	087808	13,35
803 Lg-T 30	250	360	5,52	087815	15,50

Elektrikářský šroubovák

Viz kapitola nářadí s ochrannou izolací / elektrikářské nářadí strana 247–248



803 Sada šroubováků

- Safety-Insert-System, 2komponentní vložka z měkké pěny. Vložka vhodná také pro HAZET-Assistent



2/3		
-----	--	--

803 • \ominus
0.4 x 2.5 • 0.5 x 3
0.6 x 3.5 • 0.8 x 4
1.2 x 6.5 • 1.2 x 8

801 NK • \ominus
1 x 5.5

803-PZ • \oplus
PZ 1 • PZ 2

801 NK-PH • \oplus
PH 2

803-PH • \oplus
PH 1 • PH 2 • PH 3

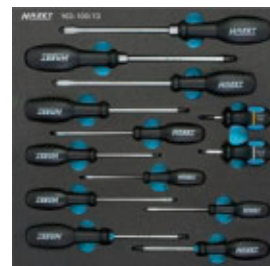

HAZET No.	d x š mm	mm	EAN-No. 4000896+	€
163-100/13	344 x 342	13	145713	101,80



Ruční nářadí

Šroubováky/bity



805 C Šroubovák se svorkou

Made in Germany

• Univerzální šroubovák pro každodenní použití – vždy po ruce

- Vyztužená škrabka pro šetrné odstraňování např. nálepek
- Klip pro uložení např. do náprsní kapsy a kapsy na rukávu
- Otočný klip – pro lepší manipulaci při šroubování
- Kulatá čepel
- Plastová rukojeť
- Povrch: čepel chromovaná

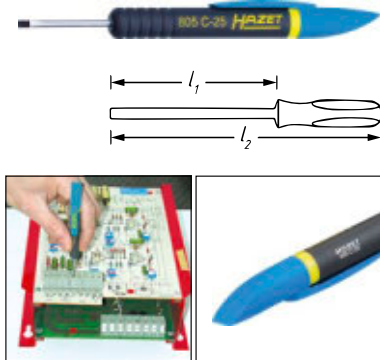

HAZET No.	l_1 mm	l_2 mm	$\frac{b}{d}$ mm	b mm	EAN-No. 4000896+	€
805 C-25	30	130	0,4	2,5	089123	11,70

805 Elektronické šroubováky

- Pro nejmenší šrouby
- Otočné středící tlačítko
- Stabilní držení díky širokým úchopovým drážkám
- Kulatá čepel
- 2komponentní rukojeť
- Povrch: špička mořená



HAZET No.	l_1 mm	l_2 mm	$\frac{b}{d}$ mm	b mm	EAN-No. 4000896+	€
805-02	60	153	0,4	2	032594	6,70
805-025	75	168	0,4	2,5	032600	6,70
805-03	75	168	0,5	3	032617	6,70

805 Sada elektronických šroubováků

- Plastová skříňka
- 2komponentní rukojeť
- \ominus 0,3 x 1,5 · 0,4 x 2 · 0,4 x 2,5 · 0,5 x 3
- \odot PH 00 · PH 0 · PH 1



HAZET No.	$d \times \text{š} \times v$ mm	$\frac{b}{d}$	EAN-No. 4000896+	€
805/7	205 x 125 x 20	7	032655	50,35

808 Sada elektronických šroubováků

- Plastová skříňka
- 2komponentní rukojeť
- \odot T 5 · T 6 · T 7 · T 8 · T 9 · T 10 · T 15



808 Sada elektronických šroubováků

HAZET No.	$d \times \text{š} \times v$ mm	$\frac{b}{d}$	EAN-No. 4000896+	€
808/7	205 x 125 x 20	7	055050	60,65

805 Sada elektronických šroubováků

- Safety-Insert-System, 2komponentní vložka z měkké pěny. Vložka vhodná také pro HAZET-Assistent

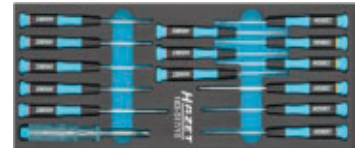

HAZET No.	$d \times \text{š}$ mm	l mm	b mm	$\frac{b}{d}$	EAN-No. 4000896+	€
Hodí se pro HAZET Assistent s hloubkou zásuvky 398 mm: 173 · 179 · 179 N · 179 W · 179 N W · 179 BIG-1 · 179 XL · 179 N XL · 179 XXL · 179 N XXL · 179 A XXL · 179 T XXL · 180						
805	\ominus , \odot , \odot					
805/7	· 808/7	· 0,5 x 2,8				
163-517/15	392 x 172	392	172	15	218745	112,-

839 Zkoušečka napětí

Made in Germany

- 220–250 V podle VDE 0680
- Břit s drážkou s dutým výbrusem
- Velmi dlouhá rukojeť, 92 mm
- Se závěsem
- Defektní žárovku Soffitte nelze podle VDE vyměnit
- Kulatá čepel
- Plastová rukojeť
- IEC 60900:2018

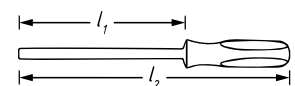

HAZET No.	l_1 mm	l_2 mm	$\frac{b}{d}$ mm	b mm	EAN-No. 4000896+	€
839-1	58	150	0,5	2,8	035670	4,05

426 Nástrčné klíče · pružné

Made in Germany

- Tvar čepel: Flexibilní
- Ergonomická 1komponentní rukojeť trinamic

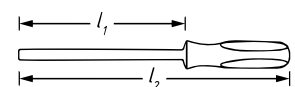

HAZET No.	l_1 mm	l_2 mm	EAN-No. 4000896+	€
426- 5	190	300	019243	30,50
426- 6	190	300	019250	30,50
426- 7	190	300	019267	30,50
426- 8	190	300	019274	30,50
426-10	190	300	019236	32,30



428 Nástrčný klíč s T-rukojetí

Made in Germany

- Krátké provedení
- Ergonomická 2komponentní T-rukojeť HAZET
- Povrch: chromováno

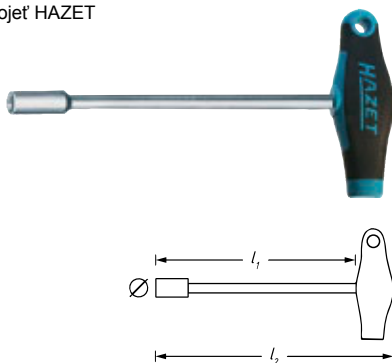

HAZET No.	l_1 mm	l_2 mm	\varnothing mm	EAN-No. 4000896+	€
• Seřízení radarové hlavy Adaptive-Cruise-Control (ACC) např. u vozidel AUDI a VW					
428- 3.5	230	256	7,2	218509	15,10
428- 6	230	256	9	019397	16,15
428- 7	230	256	11	019410	16,25
428- 8	230	264	12	019427	16,45
428-10	230	264	14	019281	19,15
428-11	230	264	16	019304	19,15
428-12	230	264	17	019328	21,55
428-13	230	264	18	019335	24,60

428 Sada nástrčných klíčů s T-rukojetí

Made in Germany

- Safety-Insert-System, 2komponentní vložka z měkké pěny.
- Vložka vhodná také pro HAZET-Assistent
- 2komponentní rukojeť T

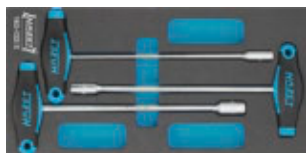
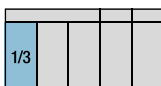

HAZET No.	$d \times \check{s}$ mm		EAN-No. 4000896+	€
163-122/3	342x172	3	153534	58,60

428 LG Nástrčný klíč s T-rukojetí

Made in Germany

- Dlouhé provedení
- Ergonomická 2komponentní T-rukojeť HAZET
- Povrch: chromováno

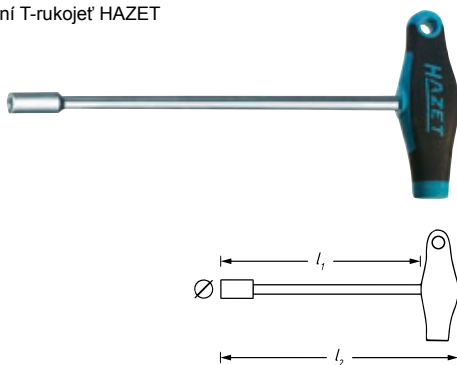

HAZET No.	l_1 mm	l_2 mm	\varnothing mm	EAN-No. 4000896+	€
428 Lg- 8	350	384	12	019601	18,05
428 Lg-10	350	384	14	019526	20,-
428 Lg-13	350	384	18	019557	25,20

828 Šroubovák s T-rukojetí

- Šestihhranná čepel
- Ergonomická 2komponentní T-rukojeť HAZET
- Povrch: chromováno, špička mořená

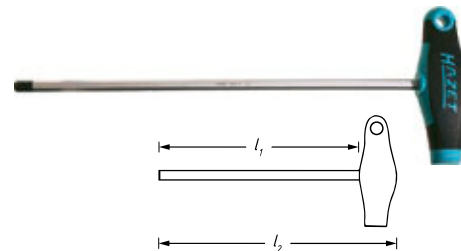

HAZET No.	S mm	l_1 mm	l_2 mm	EAN-No. 4000896+	€
828- 2	2	100	118	034123	5,85
828- 2.5	2,5	100	118	034130	5,85
828- 3	3	150	168	034161	6,45
828- 4	4	150	176	034192	7,35
828- 5	5	200	226	034222	7,90
828- 6	6	200	234	034246	8,30
828- 7	7	200	234	210060	10,75
828- 8	8	200	234	034260	9,15
828-10	10	200	234	034109	15,55

828 LG Šroubovák s T-rukojetí

- Šestihhranná čepel
- Ergonomická 2komponentní T-rukojeť HAZET
- Povrch: chromováno, špička mořená

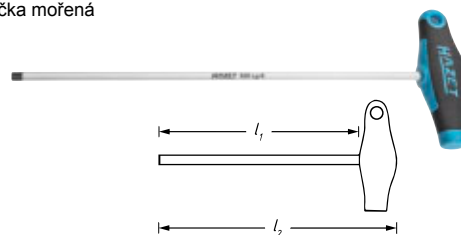

HAZET No.	S mm	l_1 mm	l_2 mm	EAN-No. 4000896+	€
828 Lg-6	6	300	334	226672	12,20

828-T Šroubovák s T-rukojetí

- Kulatá čepel
- Ergonomická 2komponentní T-rukojeť HAZET
- Povrch: chromováno, špička mořená

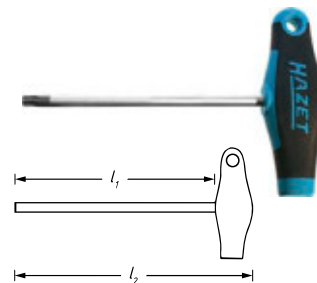

HAZET No.	l_1 mm	l_2 mm	\varnothing mm	EAN-No. 4000896+	€
828-T 6	80	98	1,67	034451	6,40
828-T 7	80	98	1,99	034468	6,40
828-T 8	80	98	2,31	034475	7,60
828-T 9	80	98	2,50	034482	7,60
828-T 10	100	126	2,74	034291	8,75
828-T 15	100	126	3,27	034307	8,75
828-T 20	100	126	3,86	034321	8,75
828-T 25	110	136	4,43	034345	9,40
828-T 27	120	146	4,99	034376	10,10
828-T 30	130	156	5,52	034383	10,40
828-T 40	130	164	6,65	034413	11,50
828-T 45	130	164	7,82	034420	12,65



Ruční nářadí

Šroubováky/bity



828 Sada šroubováků s T-rukojetí

- Safety-Insert-System, 2komponentní vložka z měkké pěny. Vložka vhodná také pro HAZET-Assistent
- 2komponentní rukojeť T



1/3				
-----	--	--	--	--



828-T •

T 6 • T 7 • T 8 • T 9 • T 10
T 15 • T 20 • T 25 • T 30

HAZET No.	d x š mm		EAN-No. 4000896+	€
163-182/9	342x172	9	162352	91,45

828 LG-T Šroubovák s T-rukojetí

- Extra dlouhé provedení
- Kulatá čepel
- Ergonomická 2komponentní T-rukojeť HAZET
- Povrch: chromováno, špička mořená

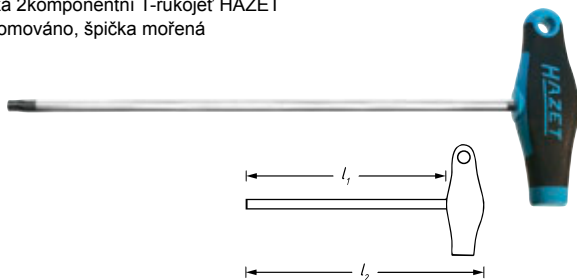

HAZET No.	l ₁ mm	l ₂ mm		EAN-No. 4000896+	€
828 Lg-T 20	200	226	3,86	139941	13,-
828 Lg-T 30	290	316	5,52	116638	17,70
828 Lg-T 40	290	325	6,65	235360	17,70

829 KK Šroubovák s T-rukojetí

- Šestihranná čepel
- S kulovou hlavou
- Ergonomická 2komponentní T-rukojeť HAZET
- Povrch: chromováno, špička mořená

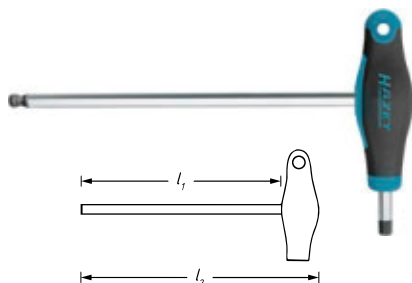

HAZET No.	S mm	l ₁ mm	l ₂ mm	EAN-No. 4000896+	€
829 KK-2	2	100	118	232895	7,10
829 KK-2.5	2,5	100	118	232901	7,10
829 KK-3	3	150	168	232918	8,15
829 KK-4	4	150	168	232925	8,15
829 KK-5	5	200	176	233038	9,15
829 KK-6	6	200	234	233045	10,80
829 KK-8	8	200	234	233052	12,85

829 KK Sada šroubováků s T-rukojetí

- Šestihranná čepel
- S kulovou hlavou
- Ergonomická 2komponentní T-rukojeť HAZET
- Povrch: chromováno, špička mořená



829 KK •

2 • 2.5 • 3 • 4 • 5 • 6 • 8

HAZET No.		EAN-No. 4000896+	€
829 KK/7	7	232888	46,25

829 KKT Šroubovák s T-rukojetí

- Šestihranná čepel
- S kulovou hlavou
- Ergonomická 2komponentní T-rukojeť HAZET
- Povrch: chromováno, špička mořená



HAZET No.	l ₁ mm	l ₂ mm		EAN-No. 4000896+	€
829 KK T-T 9	130	165	2,50	233069	8,25
829 KK T-T 10	80	98	2,74	233137	9,80
829 KK T-T 15	80	98	3,27	233144	9,80
829 KK T-T 20	100	126	3,86	233168	9,80
829 KK T-T 25	100	126	4,43	233175	10,80
829 KK T-T 30	110	136	5,52	233182	11,30
829 KK T-T 40	130	156	6,65	233199	11,85

829 KKT Sada šroubováků s T-rukojetí

- Šestihranná čepel
- S kulovou hlavou
- Ergonomická 2komponentní T-rukojeť HAZET
- Povrch: chromováno, špička mořená



829 KKT •

T 9 • T 10 • T 15 • T 20
T 25 • T 30 • T 40

HAZET No.		EAN-No. 4000896+	€
829 KK T/7	7	233014	49,85



2100 Úhlový šroubovák

- Povrch: niklováno
- DIN ISO 2936

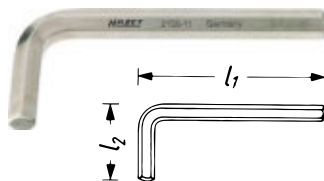

* = Mimo řady DIN

HAZET No.	S mm	l ₁ mm	l ₂ mm	EAN-No. 4000896+	€
2100-015	1,5	46,5	15,5	011261	2,-
2100-02	2	52	18	011278	2,-
2100-025	2,5	58,5	20,5	011285	2,20
2100-03	3	66	23	011308	2,30
2100-04	4	74	29	011322	2,30
2100-05	5	85	33	011346	2,60
2100-06	6	96	38	011353	2,65
2100-07	7	102	41	011360	3,45
2100-08	8	108	44	011377	3,85
2100-09 *	9	119	47	011391	4,80
2100-10	10	122	50	011407	5,30
2100-11 *	11	130	53	011414	6,35
2100-12	12	137	57	011421	6,45
2100-14	14	154	70	011445	10,10
2100-17	17	177	80	011452	14,65
2100-19	19	199	89	011469	17,30
2100-22	22	222	102	011476	28,15
2100-24	24	248	114	011483	35,90
2100-27	27	277	127	011490	59,15

2100 Sada úhlových šroubováků

- Plastový držák
- Povrch: niklováno
- DIN ISO 2936



HAZET No.	EAN-No. 4000896+	€
2100 • O 3 • 4 • 5 • 6 • 8 • 10		
2100/6 H	011551	19,55

- Na kroužku
- Povrch: niklováno
- DIN ISO 2936



HAZET No.	EAN-No. 4000896+	€
Metrické rozměry		
2100 • O 2 • 2,5 • 3 • 4 • 5 • 6 • 8		
2100/7 R	011599	10,20
Americké rozměry		
2100 A • O 3/32 • 1/8 • 5/32 • 3/16 • 7/32 • 1/4 • 5/16		
2100 A/7 R	011773	10,20

2100 Sada úhlových šroubováků

- Plastová taška
- Povrch: niklováno
- DIN ISO 2936



HAZET No.	EAN-No. 4000896+	€
Metrické rozměry		
2100 • O 2 • 3 • 4 • 5 • 6 • 7 • 8 • 9 • 10 • 12		
2100/10 P	011506	29,80
Metrické rozměry		
2100 • O 2 • 3 • 4 • 5 • 6 • 7 • 8 • 9 • 10 • 12 • 14 • 17 • 19 • 22		
2100/14 P	011537	81,20
Americké rozměry		
2100 A • O 5/64 • 3/32 • 1/8 • 5/32 • 3/16 • 7/32 • 1/4 • 5/16 • 3/8 • 1/2 • 9/16 • 5/8 • 3/4		
2100 A/13 P	011766	60,65

- Plastový zavírací držák
- Povrch: niklováno
- DIN ISO 2936

s 2,5 • 3 • 4 • 5 • 6 • 8



HAZET No.	EAN-No. 4000896+	€
2100/6 KH	072590	17,30

2105 LG Úhlový šroubovák

- Strana kulové hlavy = rozsah otáčení 20°
- Extra dlouhé provedení
- S kulovou hlavou
- Povrch: niklováno

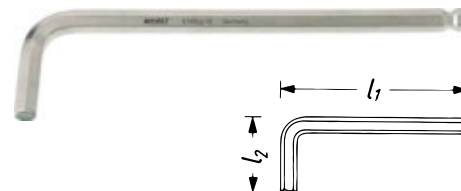
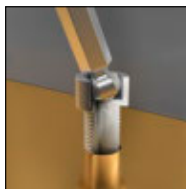

HAZET No.	S mm	l ₁ mm	l ₂ mm	EAN-No. 4000896+	€
2105 Lg-015	1,5	91,5	15,5	011896	2,80
2105 Lg-02	2	102	18	011902	2,80
2105 Lg-025	2,5	114,5	20,5	011919	3,40
2105 Lg-03	3	129	23	011926	3,55
2105 Lg-04	4	144	29	011933	3,55
2105 Lg-05	5	165	33	011940	3,85
2105 Lg-06	6	186	38	011957	5,30
2105 Lg-07	7	197	41	011964	5,65
2105 Lg-08	8	208	44	011971	6,40
2105 Lg-10	10	234	50	011988	8,-
2105 Lg-12	12	262	57	011995	8,90



2105 LG Sada úhlových šroubováků

- Extra dlouhé provedení
- S kulovou hlavou
- Plastový držák
- Povrch: niklováno

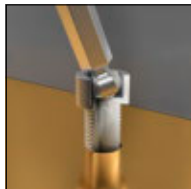

HAZET No.		EAN-No. 4000896+	€
2105 LG • O			
1.5 • 2 • 2.5 • 3 • 4 • 5 • 6 • 8 • 10			
2105 Lg/9 H	9	012015	40,05
O 0.05 • 1/16 • 5/64 • 3/32 • 1/8 • 5/32 • 3/16 • 7/32 • 1/4 • 5/16			
2105 ALG • O			
2105 A Lg/10 H	10	083749	47,10

2115 Úhlový šroubovák

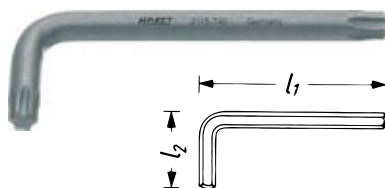

HAZET No.	l ₁ mm	l ₂ mm	mm	EAN-No. 4000896+	€
2115-T 6	44,5	18,5	1,67	012220	4,80
2115-T 7	50,5	18,5	1,99	012244	4,80
2115-T 8	51	19	2,31	012251	4,80
2115-T 9	51	19	2,50	012268	4,80
2115-T 10	54	20	2,74	012121	5,15
2115-T 15	57,5	21,5	3,27	012138	5,35
2115-T 20	61	23	3,86	012145	5,60
2115-T 25	64,5	24,5	4,43	012152	6,35
2115-T 27	69,5	26,5	4,99	012169	6,60
2115-T 30	76	30	5,52	012176	6,85
2115-T 40	83	33	6,65	012183	7,35
2115-T 45	91	37	7,82	012190	8,80
2115-T 50	104	41	8,83	012206	9,80
2115-T 55	120	47	11,22	012213	13,75
2115-T 60	134	52	13,25	012237	18,65

2115 Sada úhlových šroubováků

- Na kroužku



2115 Sada úhlových šroubováků

HAZET No.		EAN-No. 4000896+	€
2115 • O			
T 8 • T 10 • T 15 • T 20 • T 25 • T 30 • T 40			
2115-T/7 R	7	012114	22,10

- Plastová taška



HAZET No.		EAN-No. 4000896+	€
2115 • O			
T 7 • T 8 • T 9 • T 10 • T 15 • T 25 • T 27			
T 30 • T 40 • T 45 • T 50 • T 55 • T 60			
2115-T/13 P	13	012107	50,35

- Plastový zavírací držák
- O T 9 • T 10 • T 15 • T 20 • T 25 • T 27 • T 30 • T 40



HAZET No.		EAN-No. 4000896+	€
2115/8 KH	8	072583	20,45

2116 LG Sada úhlových šroubováků

Germany

- S kulovou hlavou
- Plastový držák
- O T 9 • T 10 • T 15 • T 20 • T 25 • T 27 • T 30 • T 40



HAZET No.		EAN-No. 4000896+	€
2116 Lg/8 H	8	051519	60,65



Přehled

Rozmanitost bitů HAZET

	Popis	Profil	6.3 1/4"	8 5/16"
	Bit Drážka		2208 4-8	2210 5,5-12
	Bit Křížová drážka PH		2215 (S Lg) PH 1-PH 4	2217 PH 1-PH4
	Bit Křížová drážka PZ (Pozidriv)		2216 (S Lg) PHZ 1-PZ 3	2218 PZ 1-PZ 4
	Bit Vnitřní šestihran		2204 (S Lg) 2-8	2206 5-10
	Bit Vnitřní tisícíhran (XZN)		2211 4-5	2212 6-10
	Bit Vnitřní TORX		2223 T 6-T 40	2224 T 25-T 55
	Bit dlouhý Vnitřní TORX		2223 (Lg / S Lg) T 10-T 40	2224 S Lg T 30-T 50
	Bit Tamper TORX		2223 T 7 H-T 40 H	
	Bit Vnitřní pěticípá hvězdička s čepem		2225 10 H-40 H	

Bity a příslušenství

- Speciální ocel pro nejvyšší namáhání
- Maximální rozměrová přesnost hrotů a břitů
- Pro elektricky nebo pneumaticky poháněné strojové šroubováky (utahováky) a pro manuální ovládání
- Tuhý pro závitové šrouby (tuhý šroubový spoj)
- Permanentní tvrdost 59-61 HR C pro náročné požadavky v průmyslu a řemeslech
- Vysoké hodnoty utahovacích momentů, daleko nad rámec normy DIN, dlouhá životnost





2208 Bit

- Pohon šestihran ISO 1173 C6,3 (1/4"), ISO 2351-1 C6,3



HAZET No.	l mm	φ mm	b mm	EAN-No. 4000896+	€
2208- 4	25	0,5	4	014361	2,55
2208- 6	25	0,6	4,5	014385	2,55
2208- 8	25	0,8	5,5	014408	2,55
2208- 9	25	1	6	014415	2,55
2208-10	25	1,2	6,5	014323	2,55
2208-11	25	1,2	8	014347	3,65

2215 Bit

- Pohon šestihran ISO 1173 C6,3 (1/4"), ISO 2351-2 C6,3



- + = Zesílené provedení
- * = Mimo ISO 2351-2

HAZET No.	l mm	EAN-No. 4000896+	€
2215-PH 1	25	014491	2,15
2215-PH 2	25	014521	2,15
2215-PH 3	25	014569	2,90
2215-PH 4 + *	32	014583	3,45

2216 Bit

- Pohon šestihran podobný ISO 1173 C6,3 (1/4")



HAZET No.	l mm	EAN-No. 4000896+	€
2216-PZ 1	25	014606	2,30
2216-PZ 2	25	014613	2,30
2216-PZ 3	25	014620	2,90

2223 Bit

- Pohon šestihran ISO 1173 C6,3 (1/4")



HAZET No.	l mm	φ mm	EAN-No. 4000896+	€
2223-T 6	25	1,67	015023	5,-
2223-T 7	25	1,99	015030	5,-
2223-T 8	25	2,31	015047	5,-
2223-T 9	25	2,50	015054	5,-
2223-T 10	25	2,74	014866	4,80
2223-T 15	25	3,27	014880	4,80
2223-T 20	25	3,86	014903	4,80
2223-T 25	25	4,43	014934	4,80
2223-T 27	25	4,99	014958	4,80
2223-T 30	25	5,52	014972	4,80
2223-T 40	25	6,65	014996	5,-

2223 LG Bit

- Dlouhé provedení
- Pohon šestihran podobný ISO 1173 C6,3 (1/4")



HAZET No.	l mm	φ mm	EAN-No. 4000896+	€
2223 Lg-T 25	65	4,43	015061	7,30

2223 LG Bit

- Dlouhé provedení
- Pohon šestihran podobný ISO 1173 C6,3 (1/4")
- Kruhová čepel
- Hodí se pro všechna osobní vozidla **MERCEDES-BENZ** r.v. → 2011 s příšroubovanou jednotkou airbagu



HAZET No.	l mm	φ mm	EAN-No. 4000896+	€
2223 Lg-T 30	70	5,52	015092	7,30

2223 Bit

- Pohon šestihran ISO 1173 C6,3 (1/4")



HAZET No.	l mm	φ mm	EAN-No. 4000896+	€
2223-T 7 H	25	1,99	058082	6,05
2223-T 8 H	25	2,31	058099	6,05
2223-T 9 H	25	2,50	058105	6,05
2223-T 10 H	25	2,74	014873	5,90
2223-T 15 H	25	3,27	014897	5,90
2223-T 20 H	25	3,86	014910	5,90
2223-T 25 H	25	4,43	014941	5,90
2223-T 27 H	25	4,99	014965	5,90
2223-T 30 H	25	5,52	014989	6,05
2223-T 40 H	25	6,65	015009	6,05

2204 Bit

- Pohon šestihran ISO 1173 C6,3 (1/4"), ISO 2351-3 C6,3



- * = Mimo ISO 2351-3

HAZET No.	s mm	l mm	EAN-No. 4000896+	€
2204-2	2	25	014149	2,55
2204-2.5	2,5	25	014156	2,55
2204-3	3	25	014163	2,55
2204-4	4	25	014170	2,55
2204-5	5	25	014187	2,55
2204-6	6	25	014200	2,55
2204-7 *	7	25	151332	5,85
2204-8 *	8	25	014217	2,80

2211 Bit

- DIN 65254, Pohon šestihran ISO 1173 C6,3 (1/4")



HAZET No.	l mm	EAN-No. 4000896+	€
2211-4	25	056392	5,-
2211-5	25	056408	5,-

2225 5hvězdicový bit

- Manipulace se šrouby s vnitřní 5hvězdou a čepem
- Pohon šestihran ISO 1173 C6,3 (1/4")





Ruční nářadí

Šroubováky/bity



2225 5hvězdicový bit



HAZET No.	l mm	EAN-No. 4000896+	€
2225-10 H	25	097043	7,90
2225-15 H	25	097050	7,90
2225-20 H	25	097067	7,90
2225-25 H	25	097074	8,25
2225-27 H	25	097081	8,25
2225-30 H	25	097098	8,25
2225-40 H	25	097104	9,35

863-Bit Přepínací ráčna · celokovová · na bity

Made in Germany



• 89 mm, krátké provedení

- Robustní provedení, krátký štíhlý tvar
- Ergonomická opěra prstu na konci rukojeti
- Počet zubů: 20
- Úhel ovládání: 18°
- Zahnutí v úhlu 15° – proti nebezpečí skřípnutí
- S pružinovou pojistkou pro bezpečné držení bitů
- Povrch: chromováno

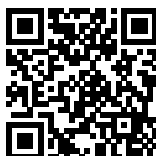

YouTube Clip



HAZET No.	l mm	EAN-No. 4000896+	€
863 M Bit	89	196111	46,80

863-Bit Přepínací ráčna pro bity · jemně ozubená

Made in Germany



• Extrémně větší výkon než u ráčen se srovnatelnými rozměry

- Aretační funkce přepínací páčky nabízí ochranu proti nechtěnému přepnutí
- Prodloužení životnosti použitím nejmodernějších maziv v ráčnovém mechanismu
- Úzké výrobní tolerance zaručují ochranu před vnikající nečistotou
- Interní standardy kvality HAZET zaručují zatížitelnost dalece nad normu
- Chromovaný povrch: Hodnotný, snadné čištění, odolný vůči korozi
- V rukojeti integrovaný prvek pro zavěšení
- VPA ověřeny, statický utahovací moment podle DIN 3122: 120 Nm (DIN: 62 Nm)
- Počet zubů: 90
- Úhel ovládání: 4°
- S pružinovou pojistkou pro bezpečné držení bitů
- 2komponentní rukojeť HAZET
- Povrch: chromováno



HiPer
HIGH PERFORMANCE
THE ORIGINAL
MADE IN GERMANY



120 Nm
HiPer

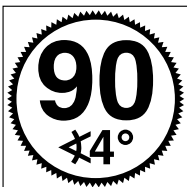

HAZET No.	l mm	EAN-No. 4000896+	€
863 HP B	116	235346	50,-

Opatření? – Žádný problém!

- Nářadí HAZET je vyrobeno v nejvyšší kvalitě. Při dlouhém, intenzivním namáhání dochází i u vysoce kvalitních nástrojů k určitému opotřebení.
- Proto nabízíme pro mnoho našich nástrojů náhradní díly a sady náhradních dílů.

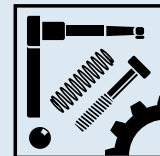

Nezapomeňte na náš obchod s náhradními díly
www.hazet.de/ersatzteil-shop

Úspora nákladů – udržitelnost – šetří zdroje!
Abyste se mohli ze svého nářadí HAZET dlouho těšit

863 Sada náhradních dílů

Made in Germany

- Počet zubů: 20
- Úhel ovládání: 18°

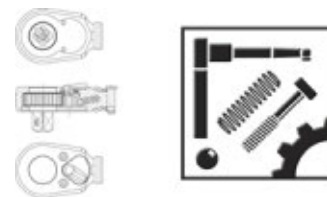

HAZET No.	EAN-No. 4000896+	€
• Sada náhradních dílů ovládací páky obsah sady: ovládací páka · fixační prvek · šrouby · kulička · tlačná pružina Pro přepínací ráčny HAZET 863 K · 863 · 863 G · 863 P · 863 PC · 863 Q · 863 S · 863 ST · 863 BGL · 863 BKC · 863 BK · 863 MC · 863 Mbit · 2264		
863 P/6	144600	7,40
• Sada náhradních dílů kolečka ráčny $\odot 6,3 = \frac{1}{4}"$ obsah sady: kolečko ráčny · fixační prvek · ovládací páka · šrouby · kulička · tlačná pružina Pro přepínací ráčnu HAZET 863 BGL · 863 BKC · 863 BK · 863 Mbit · 2264		
2264/7	015917	24,75

810 BH Držák bitů

• Bajonetový uzávěr



- Mnohostranný a flexibilní pro domácnost a dílnu
- Perfektně se doplňuje se sadami bitů HAZET
- A neodkutálí se pryč díky svému speciálnímu tvaru
- Neklouzává 3komponentní rukojeť HAZET – pro vysoký přenos síly



HAZET No.	l ₁ mm	l ₂ mm	EAN-No. 4000896+	€
810 BH	22,5	132,5	217175	9,05





810 SPC Držák bitů

- Magnet
- Neklouzavá 3komponentní rukojeť HAZET – pro vysoký přenos síly
- Povrch: matně chromováno



HAZET No.	l_1 mm	l_2 mm	EAN-No. 4000896+	€
810 SPC-6.3	100	210	165827	11,35

2255 Držák bitů

Made in Germany

- Flexibilní hřídel
- Plastová rukojeť



HAZET No.	l_1 mm	l_2 mm	EAN-No. 4000896+	€
2255-1	200	310	050079	29,80

2265 Přepínací ráčna pro bity

- Pro pohon bitů $\odot 6,3 = 1/4"$ a $\odot 8 = 5/16"$
- Magnetický držák
- Povrch: leštěný chrom

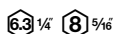

HAZET No.	l mm	EAN-No. 4000896+	€
• Přímé provedení 2265-1	140	079636	35,05

2239 Adaptér

- Permanentní magnet pro bezpečnou fixaci bitů a šroubů
- Dutinka z nerez oceli
- Pohonný šestihran, brunovaný
- DIN 7427-B, ISO 1173
- Pro vrtačky a aku šroubováky $\odot D 6,3 = 1/4"$ $\bullet C 6,3$ mm



HAZET No.	l mm	EAN-No. 4000896+	€
2239-1	60	015375	14,15

Made in Germany



- Permanentní magnet pro bezpečnou fixaci bitů a šroubů
- Dutinka z nerez oceli
- Pohonný šestihran, brunovaný
- DIN 7427-B, ISO 1173
- Pro strojní šroubováky $\odot D 6,3 = 1/4"$ $\bullet E 6,3$ mm např. AEG, Atlas Copco, Black & Decker, Bosch



2239 Adaptér

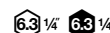

HAZET No.	l mm	EAN-No. 4000896+	€
2239-3	75	015399	18,40

- Permanentní magnet pro bezpečnou fixaci bitů a šroubů
- Pohonný šestihran, brunovaný
- DIN 7427-B, ISO 1173

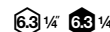

HAZET No.	l mm	EAN-No. 4000896+	€
2239-6	51,4	141418	26,15

2304 Adaptér

- Přídržná kulička
- Povrch: fosfátováno, olejováno



HAZET No.	l mm	EAN-No. 4000896+	€
• Adaptér $\blacksquare 6,3 = 1/4"$ – $\bullet 6,3 = 1/4"$ 2304	25	016020	17,50
• Adaptér $\blacksquare 12,5 = 1/2"$ – $\bullet 10 = 3/8"$ 2311	38	016068	17,55

2238 Adaptér

Made in Germany

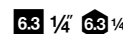

- Spojení s nástrčnými hlavicemi $\square 6,3 = 1/4"$ (DIN 3120 – A 6,3) a nářadím s pohonem $\odot 6,3 = 1/4"$, (ISO 1173-E 6,3)
- Přídržná kulička
- Povrch: mořeno, olejováno



HAZET No.	l mm	EAN-No. 4000896+	€
2238-1	50	063741	16,15

2250 Adaptér

Made in Germany

- Pro ruční manipulaci
- Uchycení vnitřní 4hran a vnitřní 6hran
- Přídržná kulička pro bity
- Povrch: chromováno



HAZET No.	l mm	EAN-No. 4000896+	€
• $\odot 6,3 = 1/4"$ – $\square 6,3 = 1/4"$ 2250-1	23,5	015443	12,-
• $\odot 6,3 = 1/4"$ – $\square 10 = 3/8"$ 2250-2	30	015450	15,95
• $\odot 6,3 = 1/4"$ – $\square 12,5 = 1/2"$ 2250-4	35	015504	17,40



Ruční nářadí

Šroubováky/bity



2272 Sada bitového rázového šroubováku

- Manipulace s pevnými šroubovými spoji
- Povolovací nebo utahovací moment do 80 Nm
- S přepínáním (pravý a levý závit)
- Rukojeť rázového utahováku otočte před každým rázem pro předepnutí doleva (uvolnění nebo pravý závit) nebo doprava (utažení nebo levý závit). 300g kladivem udeřte na horní stranu rázového utahováku
- Nejsou zapotřebí žádný elektrický proud, stlačený vzduch nebo jiné pomůcky



1/9					
-----	--	--	--	--	--

2206 • • • •
5 • 6 • 8 • 10

2217 • • • •
PH 2 • PH 3 • PH 4

2272 • • •

2210 • • • •
0.8x5.5 • 1x5.5 • 1.2x6.5
1.6x8 • 2x12

2224 • • • •
T 30 • T 40 • T 45 • T 50

HAZET No.	d x š x v mm		EAN-No. 4000896+	€
2272/23 N	185x153x52	23	192687	143,40

2210 Bit

- Pohon šestihran ISO 1173 C8 (5/16"), ISO 2351-1 C8



HAZET No.	l mm		b mm	EAN-No. 4000896+	€
2210- 8	41	0,8	5,5	014477	5,15
2210- 9	41	1	5,5	014484	5,15
2210-10	41	1,2	6,5	014422	5,15
2210-12	41	1,6	8	014446	5,15
2210-14	41	2	12	014460	7,05

2217 Bit

- Pohon šestihran ISO 1173 C8 (5/16"), ISO 2351-2 C8



+ = Zesílené provedení

HAZET No.	l mm	EAN-No. 4000896+	€
2217-PH 1	32	014651	3,45
2217-PH 2	32	014668	3,45
2217-PH 3	32	014682	3,45
2217-PH 4 +	38	014699	4,65

2218 Bit

- Pohon šestihran podobný ISO 1173 C8 (5/16")



+ = Zesílené provedení

HAZET No.	l mm	EAN-No. 4000896+	€
2218-PZ 1	32	014705	3,65
2218-PZ 2	32	014712	3,65
2218-PZ 3	32	014729	3,65
2218-PZ 4 +	38	014736	5,-

2224 Bit

- Pohon šestihran ISO 1173 C8 (5/16")



HAZET No.	l mm		EAN-No. 4000896+	€
2224-T 25	35	4,43	015115	5,30
2224-T 27	35	4,99	015122	5,30
2224-T 30	35	5,52	015139	5,30
2224-T 40	35	6,65	015160	6,-
2224-T 45	35	7,82	015177	6,20
2224-T 50	35	8,83	015184	6,45
2224-T 55	35	11,22	015191	6,75

2224 SLG Bit

- Dlouhé provedení
- Pohon šestihran ISO 1173 C8 (5/16")

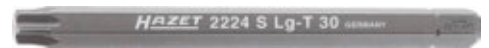

HAZET No.	l mm		EAN-No. 4000896+	€
2224 S Lg-T 30	100	5,52	015245	14,15
2224 S Lg-T 40	100	6,65	015252	15,20
2224 S Lg-T 45	100	7,82	015269	15,20
2224 S Lg-T 50	100	8,83	015283	15,60

2206 Bit

- Pohon šestihran ISO 1173 C8 (5/16"), ISO 2351-3 C8



* = Mimo ISO 2351-3

HAZET No.	s mm	l mm	EAN-No. 4000896+	€
2206- 5	5	30	014262	3,75
2206- 6	6	30	014279	3,75
2206- 7	7	30	151349	6,25
2206- 8	8	30	014286	3,80
2206-10 *	10	30	014255	4,25

2212 Bit

- DIN 65254, Pohon šestihran ISO 1173 C8 (5/16")



HAZET No.	l mm	EAN-No. 4000896+	€
2212- 6	32	056415	6,20
2212- 8	32	056422	6,20
2212-10	32	056439	6,20



2264 Přepínací ráčna pro bity

Made in Germany

• Povrch: chromováno, leštěno



HAZET No.	l mm	EAN-No. 4000896+	€
2264-1	200	015894	52,40

Opotřebení? – Žádný problém!

- Nářadí HAZET je vyrobeno v nejvyšší kvalitě. Při dlouhém, intenzivním namáhání dochází i u vysoce kvalitních nástrojů k určitému opotřebení.
- Proto nabízíme pro mnoho našich nástrojů náhradní díly a sady náhradních dílů.

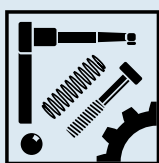

Nezapomeňte na náš obchod s náhradními díly
www.hazet.de/ersatzteil-shop

Úspora nákladů – udržitelnost – šetří zdroje!
Abyste se mohli ze svého nářadí HAZET dlouho těšit

8816 Sada náhradních dílů

Made in Germany

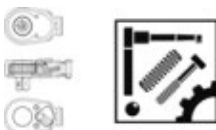

HAZET No.	EAN-No. 4000896+	€
• Sada náhradních dílů ovládací páky obsah sady: ovládací páka · šrouby · kulička · tlačná pružina · fixační prvek Pro přepínací ráčnu HAZET 8816 G · 8816 GK · 8816 P · 8816 S · 8816 ST 916 K · 2264-1 Pro momentový klíč HAZET 5110-2 CT · 5120-2 CT · 5110-3 CT · 5111-3 CT · 5120-3 CT 6110 CT · 6110-1 CT · 6111-1 CT 6114-1 CT · 6115-1 CT 6402-1 · 6402-1 S · 6408-1		
8816 P/6	144617	8,15
• Sada náhradních dílů kolečka ráčny $\odot 8 = \frac{5}{16}$ " obsah sady: kolečko ráčny · fixační prvek · ovládací páka · šrouby · kulička · tlačná pružina Pro přepínací ráčnu HAZET 2264-1 · 6408-1		
2264-1/7	015900	26,10

2272 Bitový rázový šroubovák

- Manipulace s pevnými šroubovými spoji rázem
- Povolovací nebo utahovací moment do 80 Nm
- S přepínáním (pravý a levý závit)
- Rukojeť rázového utahováku otočte před každým rázem pro předeptnutí doleva (uvolnění nebo pravý závit) nebo doprava (utažení nebo levý závit). 300g kladivem udeřte na horní stranu rázového utahováku
- Nejsou zapotřebí žádný elektrický proud, stlačený vzduch nebo jiné pomůcky



HAZET No.	l mm	EAN-No. 4000896+	€
2272	165	015979	77,75

8808 S Adaptér pro rázový · strojový utahovák

Made in Germany



- Uchycení nástrčných klíčů pro strojní šroubováky s \square nástrčným otvorem 10 = $\frac{3}{8}$ "
- S kolíkovou pojistkou
- Povrch: ocelově šedý, olejovaný



HAZET No.	l mm	EAN-No. 4000896+	€
8808 S-1	75	040032	26,70

2250 Adaptér

- Pro ruční manipulaci
- Uchycení vnitřní 4hran a vnitřní 6hran
- Přídržná kulička pro bity
- Povrch: chromováno



HAZET No.	l mm	EAN-No. 4000896+	€
• $\odot 8 = \frac{5}{16}$ " – $\square 10 = \frac{3}{8}$ "			
2250-3	31	015474	16,20
• $\odot 8 = \frac{5}{16}$ " – $\square 12,5 = \frac{1}{2}$ "			
2250-5	36	015511	17,50





Ruční nářadí

Kleště



Kleště



Kombinované kleště [1850] / silové kombinované kleště [1851]		202
Kleště na drát [1802-1804]		202-203
Ploché kleště / úzké ploché kleště [1841]		203
Rabicové/monýrovací kleště [1810]		204
Univerzální kleště [760] / rohové hasáky [2183]		204-205
Kleště na dráty [1811]		205
Kleště na pojistné kroužky [1845/1846/1847]		205-208
Skřípcové kleště [752-758]		209-210
Kleště na hadicové spony [798]		210-213
Kleště s ochrannou izolací [759 VDE / 1816 VDE - 1860 VDE]		249-250
Krimpovací kleště [4656/4658]		251
Kleště na konektory zapalovacích svíček [1849] / kleště na konektory žhavicích svíček [4760]		385/389
Kleště na pístní kroužky [790]		391
Kleště na těsnicí kroužky ventilového dřívku [791/2991]		391-392
Kleště na palivové vedení [4501]		394
Kleště na uvolňování svorek [4590]		394-395
Kleště na brzdové pružiny [796/797]		423
Skřípcové/upínací kleště [1847]		447
Kleště na vyvažovací závaží [665]		450
Nůžky na karosářské plechy [1961] / odsazovací kleště [1932] / děrovací kleště [1964]		460
Kleště pro ruční nýtování [1963]		461



Povrch kleští HAZET

Špičková kvalita pro dlouhou životnost

Chromováno ve vysokém lesku



- Odolnost proti nabíhání
- Odolnost proti vzduchu, vodě, zředěným kyselinám a většině louhů
- Ochrana proti korozi a opotřebení
- Ušlechtilý vzhled

Pískované a leštěné



- Antireflexní materiál
- Vyšší odolnost proti poškrábání, a tudíž delší životnost

Rukojeti

Ergonomicky tvarované



① Maximální bezpečnost díky ochraně proti sesmeknutí

② 2komponentní rukojeť – Vynikající haptika díky promyšlenému rozdělení tvrdých a měkkých zón

③ Ergonomický tvar – odolnost proti únavě při dlouhodobém používání

Třídy drátu

Řezné hodnoty podle DIN ISO 5744:

Příklady materiálů	Tvrdość drátu	Pevnost v tahu N/mm ²		
	Středně tvrdý	cca 800	Hřebík, drátový kolík	
	Tvrdý drát	cca 1600	Ocelový drát, drátěné lano	
	Pianový drát	cca 2300	Pružinový drát	



Legenda k piktogramům

	Pro plochý materiál u kleští
	Pro kulatý materiál u kleští
	Kleště s fazetou
	Kleště bez fazety
	Kulaté kleště

	Ploché kleště
	Půlkulaté kleště
	Vnitřní pojistky
	Vnější pojistky

Malá násobilka kleští HAZET

Druhy kloubů

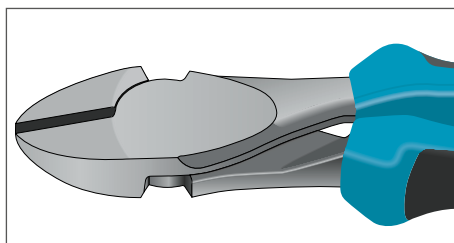

Podepřený kloub:

Zde na sebe obě poloviny kleští dosedají bez zvláštních úprav.

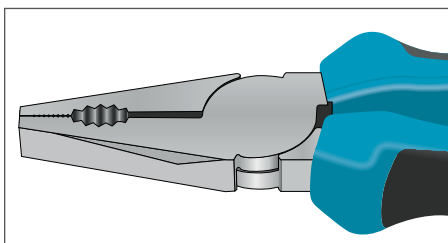

Vložený kloub:

Zde je každé rameno kleští upraveno až do poloviny v příslušné oblasti kloubu tak, aby obě ramena kleští dosedala volitelně do sebe.



Prostrčený kloub:

Zde má jedna polovina ramene kleští drážku, aby druhá polovina byla přesně prostrčena. Výhody: Díky oboustrannému uložení kloubového čepu a dvojitému vedení vnitřních ramen kleští tento kloubový spoj odolává vysokým zátěžím.

Tvary čelistí



Ploché



Úzké ploché

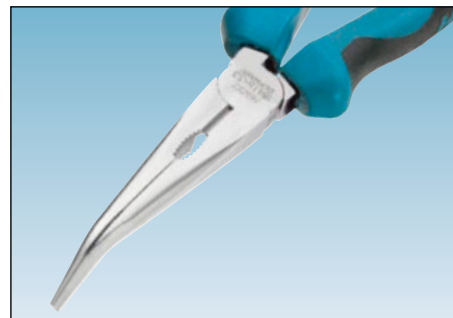

Zahnuté do tupého úhlu

Úchopová plocha

- Rýhováno podle normy DIN ISO 5742





Kleště

1850 Kombinované kleště

Made in Germany

- Indukčně kalený břit s ostřím
- Tvrdost ostří: 60 HRC
- Ergonomické 2komponentní plastové kryty rukojetí HAZET (modrá/černá)
- Povrch: leštěný chrom
- DIN ISO 5746



HAZET No.	l mm	Rm N/mm ² ○ 800	Rm N/mm ² ● 1600	EAN-No. 4000896+	€
1850-22	170	3	2	007141	37,75
1850-33	190	3,2	2,2	007165	42,90

1850 M Kombinované kleště

Made in Germany

- Indukčně kalený břit s ostřím
- Tvrdost ostří: 60 HRC
- Ergonomické 2komponentní plastové kryty rukojetí HAZET (modrá/černá)
- Povrch: leštěno, pískováno
- DIN ISO 5746



HAZET No.	l mm	Rm N/mm ² ○ 800	Rm N/mm ² ● 1600	EAN-No. 4000896+	€
1850 M-22	160	2,5	1,8	145034	21,50
1850 M-33	180	2,8	2,5	144747	23,-

1851 Silové kombinované kleště

Made in Germany

- Snížená námaha díky přesunutí bodu otáčení k břitu

- Indukčně kalený břit s ostřím
- Tvrdost ostří: 64 HRC
- Ergonomické 2komponentní plastové kryty rukojetí HAZET (modrá/černá)
- Povrch: chromováno, lesklá hlava
- DIN ISO 5746



HAZET No.	l mm	Rm N/mm ² ○ 800	Rm N/mm ² ● 1600	Rm N/mm ² ● 2300	EAN-No. 4000896+	€
1851-44	210	3,8	2,7	2,2	055081	50,10

1851 M Silové kombinované kleště

Made in Germany

- Snížená námaha díky přesunutí bodu otáčení k břitu

- Indukčně kalený břit s ostřím
- Tvrdost ostří: 64 HRC
- Ergonomické 2komponentní plastové kryty rukojetí HAZET (modrá/černá)
- Povrch: leštěno, pískováno
- DIN ISO 5746



HAZET No.	l mm	Rm N/mm ² ○ 800	Rm N/mm ² ● 1600	Rm N/mm ² ● 2300	EAN-No. 4000896+	€
1851 M-44	200	3,8	2,7	2,2	144914	30,15

1803 Stranové štípačky

Made in Germany

- Kloub bez vůle, s lehkým chodem
- Vložený kloub
- Indukčně kalený břit s ostřím
- Tvrdost ostří: 62 HRC
- Ergonomické 2komponentní plastové kryty rukojetí HAZET (modrá/černá)
- Povrch: leštěný chrom
- DIN ISO 5749



HAZET No.	l mm	Rm N/mm ² ○ 800	Rm N/mm ² ● 1600	EAN-No. 4000896+	€
1803-11	145	2,5	1,8	093854	43,80
1803-22	165	2,8	2	006106	46,35

1803 M Stranové štípačky

Made in Germany

- Kloub bez vůle, s lehkým chodem
- Vložený kloub
- Indukčně kalený břit s ostřím
- Tvrdost ostří: 62 HRC
- Ergonomické 2komponentní plastové kryty rukojetí HAZET (modrá/černá)
- Povrch: leštěno, pískováno
- DIN ISO 5749



HAZET No.	l mm	Rm N/mm ² ○ 800	Rm N/mm ² ● 1600	EAN-No. 4000896+	€
1803 M-11	145	2,5	1,8	145218	24,35
1803 M-22	165	2,8	2	144945	25,50
1803 M-33	180	3	2,5	145225	28,35

1802 Silové stranové štípačky

Made in Germany

- Menší vynaložení síly díky umístění středu otáčení u čelistí

- Kované provedení
- Kloub bez vůle, s lehkým chodem
- Položený kloub
- Indukčně kalený břit s ostřím
- Tvrdost ostří: 64 HRC
- Ergonomické 2komponentní plastové kryty rukojetí HAZET (modrá/černá)
- Povrch: leštěný chrom
- DIN ISO 5749



HAZET No.	l mm	Rm N/mm ² ○ 800	Rm N/mm ² ● 1600	Rm N/mm ² ● 2300	EAN-No. 4000896+	€
1802-11	160	3,5	2,5	2	006038	44,55
1802-22	180	3,8	2,7	2,2	006052	50,20
1802-33	200	4,2	3	2,5	006076	59,50

1802 M Silové stranové štípačky

Made in Germany

- Menší vynaložení síly díky umístění středu otáčení u čelistí

- Kované provedení
- Kloub bez vůle, s lehkým chodem
- Položený kloub
- Indukčně kalený břit s ostřím
- Tvrdost ostří: 64 HRC
- Ergonomické 2komponentní plastové kryty rukojetí HAZET (modrá/černá)
- Povrch: leštěno, pískováno
- DIN ISO 5749



HAZET No.	l mm	Rm N/mm ² ○ 800	Rm N/mm ² ● 1600	Rm N/mm ² ● 2300	EAN-No. 4000896+	€
1802 M-11	160	3,5	2,5	2	144730	29,75
1802 M-22	180	3,8	2,7	2,2	144525	32,10
1802 M-33	200	4,2	3	2,5	144938	34,80



Ruční nářadí

Kleště



1804 N Pákové stranové štípací kleště

Made in Germany

- Výkonová třída H (pianový drát, tvrzený ocelový drát)
- Pákový převod **redukuje vynaloženou sílu o 40 %**
- Rozevírací pružina a aretace
- Indukčně kalené břity s ostřím
- Tvrdost ostří: 64 HRC
- Rukojeť s povrchovou úpravou máčením
- DIN ISO 5747



HAZET No.	l mm	Rm N/mm ² Ø 800	Rm N/mm ² ● 1600	Rm N/mm ² ● 2300	EAN-No. 4000896+	€
1804 N-2	160	3	2,7	2,2	086276	60,10

Kleště · s ochrannou izolací

Viz kapitola nářadí s ochrannou izolací / elektrikářské nářadí strana 249–250



1841 A Půlkulaté kleště

Made in Germany

- Ploché kulatý tvar, indukčně kalené břity
- Přímé provedení
- Tvrdost ostří: 60 HRC
- Ergonomické 2komponentní plastové kryty rukojetí HAZET (modrá/černá)
- Povrch: leštěný chrom
- DIN ISO 5745



HAZET No.	l mm	Rm N/mm ² Ø 800	Rm N/mm ² ● 1600	EAN-No. 4000896+	€
1841 a-22	165	2,5	1,6	006366	37,75
1841 a-33	205	2,8	1,8	006380	44,45

1841 MA Půlkulaté kleště

Made in Germany

- Ploché kulatý tvar, indukčně kalené břity
- Přímé provedení
- Tvrdost ostří: 60 HRC
- Ergonomické 2komponentní plastové kryty rukojetí HAZET (modrá/černá)
- Povrch: leštěno, pískováno
- DIN ISO 5745



HAZET No.	l mm	Rm N/mm ² Ø 800	Rm N/mm ² ● 1600	EAN-No. 4000896+	€
1841 M a-11	145	2,3	1,6	145232	23,25
1841 M a-22	165	2,5	1,6	144754	23,45
1841 M a-33	205	2,8	1,8	144877	27,05

1841 B Půlkulaté kleště

Made in Germany

- Ploché kulatý tvar, indukčně kalené břity
- Zahnuté provedení (45°)
- Tvrdost ostří: 60 HRC
- Ergonomické 2komponentní plastové kryty rukojetí HAZET (modrá/černá)
- Povrch: leštěný chrom
- DIN ISO 5745



HAZET No.	l mm	Rm N/mm ² Ø 800	Rm N/mm ² ● 1600	EAN-No. 4000896+	€
1841 b-33	200	2,8	1,8	006434	45,55

1841 MB Půlkulaté kleště

Made in Germany

- Ploché kulatý tvar, indukčně kalené břity
- Zahnuté provedení (45°)
- Tvrdost ostří: 60 HRC
- Ergonomické 2komponentní plastové kryty rukojetí HAZET (modrá/černá)
- Povrch: leštěno, pískováno
- DIN ISO 5745



HAZET No.	l mm	Rm N/mm ² Ø 800	Rm N/mm ² ● 1600	EAN-No. 4000896+	€
1841 M b-33	200	2,8	1,8	144891	30,85

1841 A Půlkulaté kleště

Made in Germany

- **Extra dlouhé**
- Ploché kulatý tvar
- Přímé provedení
- Rukojeť s povrchovou úpravou máčením



HAZET No.	l mm	EAN-No. 4000896+	€
1841 A-280	280	051489	50,45
1841 B-280	280	051694	52,40

1816 Ploché kleště

Made in Germany

- Ploché tvar
- Přímé provedení
- Ergonomické 2komponentní plastové kryty rukojetí HAZET (modrá/černá)
- Povrch: leštěný chrom
- Funkční rozměry podle DIN ISO 5745



HAZET No.	l mm	EAN-No. 4000896+	€
1816-22	160	006274	35,85

Made in Germany

- **Obzvlášť plochý tvar pro použití ve zúžených konstrukčních prostorech**

- Ploché tvar
- Přímé provedení
- Rukojeť s povrchovou úpravou máčením

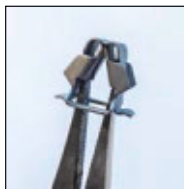

HAZET No.	l mm	EAN-No. 4000896+	€
1816 K-1	135	232949	27,75



1849 Kleště na kabelové koncovky zapalovacích svíček

Made in Germany

• Speciálně pro tepelně izolované konektory

- Použití: Stahování a nasazování konektorů zapalovacích svíček
- Přídavný břit
- Ergonomické 2komponentní plastové kryty rukojetí HAZET (modrá/černá)
- Povrch: chromováno



HAZET No.	l mm	EAN-No. 4000896+	€
1849	195	007080	40,50

Made in Germany

• Bezpečná manipulace díky vyfrézovanému vnitřnímu profilu úchopných pouzder

- Použití: Stahování a nasazování rovných konektorů zapalovacích svíček
- Vhodné zejména pro **MERCEDES-BENZ**
- Ergonomické 2komponentní plastové kryty rukojetí HAZET (modrá/černá)
- Povrch: chromováno



HAZET No.	l mm	EAN-No. 4000896+	€
1849-1	200	128037	41,35

Made in Germany

• Dlouhé provedení pro větší bezpečnou vzdálenost od horkého agregátu

- Použití: Stahování a nasazování rovných konektorů zapalovacích svíček
- Zejména pro **nizko uložené konektory zapalovacích svíček** např. na motorech **AUDI V6** resp. **V8 JAGUAR 12-válc.**
- Ergonomické 2komponentní plastové kryty rukojetí HAZET (modrá/černá)
- Povrch: chromováno



HAZET No.	l mm	EAN-No. 4000896+	€
1849-2	290	007103	47,65

Made in Germany

• Speciálně pro tepelně izolované konektory

- Použití: Stahování a nasazování konektorů zapalovacích svíček
- Dlouhé provedení
- Ergonomické 2komponentní plastové kryty rukojetí HAZET (modrá/černá)
- Povrch: chromováno



HAZET No.	l mm	EAN-No. 4000896+	€
1849-3	265	055098	47,65

1810 Rabicové/monýrovací kleště

Made in Germany

- Tvrdost ostří: 61 HRC
- DIN ISO 9242



HAZET No.	l mm	Rm N/mm ² ○ 800	Rm N/mm ² ● 1600	EAN-No. 4000896+	€
1810-250	250	3,5	2	006236	30,50

760 N Univerzální kleště

Made in Germany

- Vodicí drážky podfrézované
- Čelist indukčně kalená
- Položený drážkovaný kloub
- Povrch: chromováno
- DIN ISO 8976

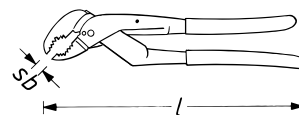

HAZET No.	l mm	sb mm	sb mm	EAN-No. 4000896+	€
760 N-1	180	30	45	030460	38,60
760 N-2	260	50	65	030484	45,80
760 N-3	310	65	80	030514	64,40
760 N-4	415	110	120	030538	92,70

760 Univerzální kleště

Made in Germany

• S rychlým pákovým ovládním: „Vždy skvěle fungují – ...neboť na páce záleží!“

- Komfortní rychlé přestavení díky **dotykové/krokové páčkové funkci**
- **Přestavení bez přehmatávání** – ovladatelné jednou rukou
- S maximálním rozsahem upnutí do SW 50 mm patří tyto kleště k největším ve své třídě
- Integrovaná ochrana proti skřípnutí zamezuje poraněním (např. zhmoždění)
- Rukojeť s povrchovou úpravou máčením
- DIN ISO 8976

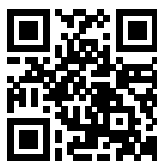
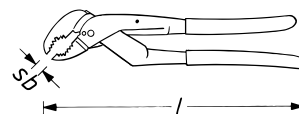

YouTube Clip



HAZET No.	l mm	sb mm	sb mm	EAN-No. 4000896+	€
760-2	260	50	50	188451	46,20



Ruční nářadí

Kleště



2183 Rohové trubkové kleště

- Švédský tvar
- Samosvorné sevření, bezpečné a pevné uchopení, také na hladkých trubkách díky 3bodovému upnutí
- Pracovní rozsah matic a trubek, 25 mm = 1" – 37 mm = 1.½" – 50 mm = 2"
- Profil rukojeti oboustranné T
- Štíhlá čelist ve tvaru S, zahnutá v úhlu 45°
- Indukčně tvrzené ozubení přesazené proti směru otáčení
- Kované provedení
- Povrch: prášková barva, klíč bezbarvý
- DIN 5234



HAZET No.	l mm	sb mm	EAN-No. 4000896+	€
2183-1.5	416	46	013753	78,10
2183-2	535	65	013760	124,20

1811 Kleště na kroucení drátu

• Přídavný břit a kostičkované čelisti

- Pravotočivé
- Zkosené o 30°
- Pro dráty do Ø 1,6 mm
- Celokovové provedení
- Hlava leštěná



HAZET No.	l mm	EAN-No. 4000896+	€
1811-250	250	078936	116,30

1845 A Kleště na pojistné kroužky

• Made in Germany

- Bezpečná a rychlá práce
- Vysoká stabilita pojistných kroužků díky vysoce přesným, konickým, podbroušeným hrotům (fosfátovaným)
- Celoplastové těleso
 - Extrémně odolné kovové jádro sahající hluboko do kleštiny
 - Lehké – ergonomický tvar
- Zpětná pružina
- Zajištění proti přetočení, hroty přivařené k masivnímu ocelovému jádru
- Přímé provedení (tvar A)
- Pro vnější pojistky
- DIN 5254



HAZET No.	l mm	mm	mm	EAN-No. 4000896+	€
1845 A- 3	140	3–10	0,9	048663	20,10
1845 A-10	140	10–25	1,3	048670	20,10
1845 A-19	180	19–60	1,8	048687	24,05

1845 B Kleště na pojistné kroužky

• Made in Germany

- Bezpečná a rychlá práce
- Vysoká stabilita pojistných kroužků díky vysoce přesným, konickým, podbroušeným hrotům (fosfátovaným)
- Celoplastové těleso
 - Extrémně odolné kovové jádro sahající hluboko do kleštiny
 - Lehké – ergonomický tvar
- Zpětná pružina
- Zajištění proti přetočení, hroty přivařené k masivnímu ocelovému jádru
- Hroty zahnuté v úhlu 90° (tvar B)
- Pro vnější pojistky



HAZET No.	l mm	mm	mm	EAN-No. 4000896+	€
1845 B- 3	130	3–10	0,9	048694	20,10
1845 B-10	130	10–25	1,3	048700	20,10
1845 B-19	172	19–60	1,8	048717	24,05

1845 C Kleště na pojistné kroužky

• Made in Germany

- Bezpečná a rychlá práce
- Vysoká stabilita pojistných kroužků díky vysoce přesným, konickým, podbroušeným hrotům (fosfátovaným)
- Celoplastové těleso
 - Extrémně odolné kovové jádro sahající hluboko do kleštiny
 - Lehké – ergonomický tvar
- Zpětná pružina
- Zajištění proti přetočení, hroty přivařené k masivnímu ocelovému jádru
- Přímé provedení (tvar C)
- Pro vnitřní pojistky
- DIN 5256



HAZET No.	l mm	mm	mm	EAN-No. 4000896+	€
1845 C- 8	140	8–11	0,9	048724	20,10
1845 C-12	140	12–25	1,3	048731	20,10
1845 C-19	180	19–60	1,8	048748	24,05





1845 D Kleště na pojistné kroužky

Made in Germany

- Bezpečná a rychlá práce
- Vysoká stabilita pojistných kroužků díky vysoce přesným, konickým, podbroušeným hrotům (fosfátovaným)
- Celoplastové těleso
 - Extrémně odolné kovové jádro sahající hluboko do kleštiny
 - Lehké – ergonomický tvar
- Zpětná pružina
- Zajištění proti přetočení, hroty přivařené k masivnímu ocelovému jádru
- Hroty zahnuté v úhlu 90° (tvar D)
- Pro vnitřní pojistky



HAZET No.	l mm	Ø mm	≡ mm	EAN-No. 4000896+	€
1845 D- 8	133	8–11	0,9	048755	20,10
1845 D-12	133	12–25	1,3	048762	20,10
1845 D-19	170	19–60	1,8	048779	24,05

1845 Sada kleští na pojistné kroužky

Made in Germany

- Bezpečná a rychlá práce
- Vysoká stabilita pojistných kroužků díky vysoce přesným, konickým, podbroušeným hrotům (fosfátovaným)
- Celoplastové těleso
 - Extrémně odolné kovové jádro sahající hluboko do kleštiny
 - Lehké – ergonomický tvar
- Zpětná pružina
- Zajištění proti přetočení, hroty přivařené k masivnímu ocelovému jádru
- DIN 5254



1845 A	1845 B	1845 C	1845 D
1845 A-10	1845 B-10	1845 C-8	1845 D-8
1845 A-19	1845 B-19	1845 C-19	1845 D-19

HAZET No.	≡	EAN-No. 4000896+	€
1845/8	8	048656	176,-

1845 Sada kleští na pojistné kroužky

Made in Germany

- Bezpečná a rychlá práce
- Vysoká stabilita pojistných kroužků díky vysoce přesným, konickým, podbroušeným hrotům (fosfátovaným)
- Celoplastové těleso
 - Extrémně odolné kovové jádro sahající hluboko do kleštiny
 - Lehké – ergonomický tvar
- Zpětná pružina
- Zajištění proti přetočení, hroty přivařené k masivnímu ocelovému jádru
- DIN 5254



1845 A-19	1845 B-19	1845 C-19	1845 D-19
-----------	-----------	-----------	-----------

HAZET No.	≡	EAN-No. 4000896+	€
1845/4	4	184132	70,10

Made in Germany

- Safety-Insert-System, 2komponentní vložka z měkké pěny. Vložka vhodná také pro HAZET-Assistent

ⓔ

1/3			
-----	--	--	--



1845 A-19	1845 B-19	1845 C-19	1845 D-19
-----------	-----------	-----------	-----------

HAZET No.	d x š mm	≡	EAN-No. 4000896+	€
163-124/4	342x172	4	153602	92,50

1846 A Kleště na pojistné kroužky

Made in Germany

- Cylindrické hroty natočené v optimálním úhlu
- Přesně definovaný, extra stabilní kuželový nástavec
- Stabilní uložení kroužku bez vůle
- Elektrotermická povrchová úprava
- Přímé provedení (tvar C)
- Pro vnitřní pojistky
- Povrch: chromováno, špička ocelově šedá
- DIN 5256 tvar C



HAZET No.	l mm	Ø mm	≡ mm	EAN-No. 4000896+	€
1846 a-0	139	8– 13	0,9	006793	33,55
1846 a-1	140	12– 25	1,3	006809	33,55
1846 a-2	180	19– 60	1,8	006816	34,80
1846 a-3	225	40–100	2,3	006823	45,95
1846 a-4	310	85–140	3,2	006830	72,-



Ruční nářadí

Kleště



1846 A Kleště na pojistné kroužky

Made in Germany

• Rychle uvolnitelná aretace pro fixaci příslušné demontážní/montážní polohy

- Ramena kleští ocelový plech
- Hroty s povrchovou úpravou, šroubované, vyměnitelné
- Přímé provedení (tvar C)
- Pro vnitřní pojistky
- Povrch: prášková barva



HAZET No.	l mm	Ø mm	≡ mm	EAN-No. 4000896+	€
Rovné pro vnitřní pojistky (otvory)					
1846 a-5	545	122-300	3,5	081271	162,20
Náhradní hroty · rovné					
• Pro 1846 a-5					
1846 a-05/2	-	-	-	081288	19,15
Výměnné hroty · 90° zahnuté					
Pro výměnu u kleští 1846 a-5					
1846 b-05/2	-	-	-	081318	19,15

1846 B Kleště na pojistné kroužky

Made in Germany

- Hroty zahnuté v úhlu 90° (tvar D)
- Pro vnitřní pojistky
- Povrch: chromováno, špička ocelově šedá
- DIN 5256 tvar D



HAZET No.	l mm	Ø mm	≡ mm	EAN-No. 4000896+	€
1846 b-0	139	8- 13	0,9	006847	35,35
1846 b-1	140	10- 25	1,3	006854	35,35
1846 b-2	180	19- 60	1,8	006861	37,-
1846 b-3	225	40-100	2,3	006878	48,60
1846 b-4	310	85-165	3,2	006885	75,45

Made in Germany

• Dlouhé špičky zahnuté 90°

- Čelisti zahnuté v úhlu 90°
- Ergonomické 2komponentní plastové kryty rukojetí HAZET (modrá/černá)
- Povrch: chromováno

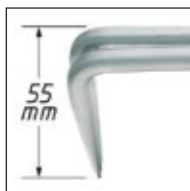

HAZET No.	l mm	Ø mm	≡ mm	EAN-No. 4000896+	€
1846 b-1.6	195	12-30	1,5	061457	49,90

1846 C Kleště na pojistné kroužky

Made in Germany

- Přímé provedení (tvar A)
- Pro vnější pojistky
- Povrch: chromováno, špička ocelově šedá
- DIN 5254 tvar A



1846 C Kleště na pojistné kroužky

HAZET No.	l mm	Ø mm	≡ mm	EAN-No. 4000896+	€
1846 c-0	139	3- 10	0,9	006892	36,55
1846 c-1	140	10- 25	1,3	006908	36,55
1846 c-2	180	19- 60	1,8	006915	37,70
1846 c-3	225	40-100	2,3	006922	49,20
1846 c-4	310	85-140	3,2	006939	76,75

Made in Germany

- Ramena kleští ocelový plech
- Hroty s povrchovou úpravou, šroubované, vyměnitelné
- Přímé provedení (tvar A)
- Pro vnější pojistky
- Povrch: prášková barva



HAZET No.	l mm	Ø mm	≡ mm	EAN-No. 4000896+	€
Přímé pro vnější pojistky (hřídele)					
1846 c-5	538	122-300	3,5	081332	162,20
Náhradní hroty · rovné					
• Pro 1846 c-5					
1846 c-05/2	-	-	-	081349	19,15
Výměnné hroty · 90° zahnuté					
Pro výměnu u kleští 1846 c-5					
1846 d-05/2	-	-	-	081370	19,15

1846 D Kleště na pojistné kroužky

Made in Germany

- Hroty zahnuté v úhlu 90° (tvar B)
- Pro vnější pojistky
- Povrch: chromováno, špička ocelově šedá
- DIN 5254 tvar B



HAZET No.	l mm	Ø mm	≡ mm	EAN-No. 4000896+	€
1846 d-0	139	3- 10	0,9	006946	38,20
1846 d-1	140	10- 25	1,3	006953	38,20
1846 d-2	180	19- 60	1,8	006960	40,40
1846 d-3	225	40-100	2,3	006977	52,15
1846 d-4	310	85-140	3,2	006984	79,70





1847 Kleště na pojistné kroužky

Made in Germany

- Čelisti zahnuté v úhlu 90°, čtverečkové hroty
- Pro vnější pojistky
- Povrch: chromováno



HAZET No.	l mm	EAN-No. 4000896+	€
1847-2	200	007011	41,35

Made in Germany

- Pro stejnoběžný kloub nebo hnací hřídel
- Čelisti zahnuté v úhlu 10°, čtverečkové hroty
- Pro vnější pojistky
- Povrch: chromováno



HAZET No.	l mm	EAN-No. 4000896+	€
1847-3	200	007028	41,35

Made in Germany

- Čelisti zahnuté v úhlu 30°
- Povrch: chromováno



HAZET No.	l mm	EAN-No. 4000896+	€
1847-6	200	050468	41,35

Made in Germany

- Čelisti zahnuté v úhlu 30°
- Povrch: chromováno



HAZET No.	l mm	EAN-No. 4000896+	€
1847-61	200	058761	41,35

1847 Sada kleští na pojistné kroužky

Made in Germany

Snadná montáž kloubu hnacího hřídele bez poškození: Poškození ozubení kloubu a hřídele je při montáži kloubu hnacího hřídele s uvnitř ležícím pojistným kroužkem zabráněno

- Snadná fixace přidržovacích kleští nad pojistným kroužkem
- Při naražení kloubu sklouznou kleště automaticky dolů
- Bezpečná práce bez poškození vlnovce
- Pro hnací hřídele všech výrobců
- Ovládání kleští jednou rukou
- Nejsou potřebné žádné další pomocné nástroje

Tip pro uživatele:

- Vsaďte do kleští vhodné poloskořepiny (průměru hřídele)
- Nasadte kleště na ozubení s předmontovaným pojistným kroužkem a upněte
- Předběžné polohování kloubu díky kónickému tvarování kleští umožňuje snadnější zavedení ozubení bez poškození
- Lze použít pro téměř všechna běžná v Evropě schválená vozidla
- SmartCase (1/3) 165-L
- Safety-Insert-System, 2komponentní vložka z měkké pěny. Vložka vhodná také pro HAZET-Assistent

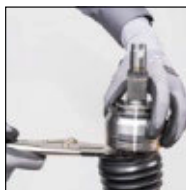

1847-12	1847-123/2	1847-126/2
1847-121/2	1847-124/2	
1847-122/2	1847-125/2	1847-127/2



YouTube Clip

HAZET No.	d x š x v mm	€	EAN-No. 4000896+	€
1847-12/15	355x235x65	15	221288	372,60

1847 Jednotlivé díly

Made in Germany

HAZET No.	EAN-No. 4000896+	€
Kleště na pojistné kroužky		
1847-12	222117	96,35
Pár poloskořepin (Ø 19 mm)		
1847-121/2	221295	36,05
Pár poloskořepin (Ø 21,4 mm)		
1847-122/2	221301	36,05
Pár poloskořepin (Ø 22,3 – 23 mm)		
1847-123/2	221318	36,05
Pár poloskořepin (Ø 23,8 – 24,6 mm)		
1847-124/2	221325	36,05
Pár poloskořepin (Ø 26,2 – 26,9 mm)		
1847-125/2	221332	36,05
Pár poloskořepin (Ø 28,5 – 29,2 mm)		
1847-126/2	221349	36,05
Pár poloskořepin (Ø 30 mm)		
1847-127/2	221356	36,05



Ruční nářadí

Kleště



757 Skřipcové kleště

Made in Germany

- Polokulaté čelisti
- Páka pro rychlé odjištění
- Odšťihovač drátu
- Povrch: niklováno

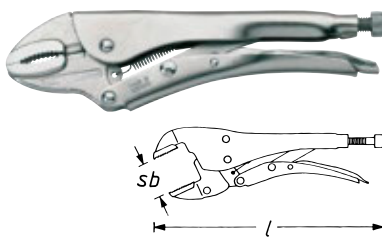

HAZET No.	l mm	sb mm	EAN-No. 4000896+	€
757- 5	140	30	062300	28,20
757- 7	180	35	030347	32,70
757-10	250	50	030293	34,50
757-12	300	65	030323	58,50

753 Skřipcové kleště

Made in Germany

- Pro drobné kulaté díly a neskladné nářadí
- Upínací čelisti planoparalelní – funkce šroubových svěrek
- Jednostranný prizmatický výřez
- Dlouhý kluzný třmen
- Páka pro rychlé odjištění
- Povrch: niklováno

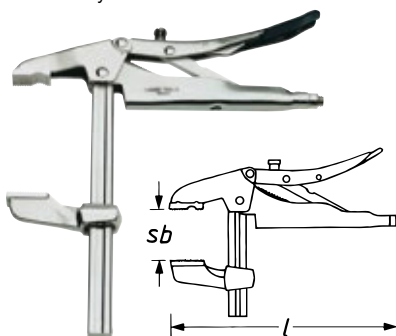

HAZET No.	l mm	sb mm	sb mm	EAN-No. 4000896+	€
753-2	260	200	5–75	030231	120,70

Made in Germany

- Rovné čelisti – pro ploché materiál
- Páka pro rychlé odjištění
- Povrch: niklováno

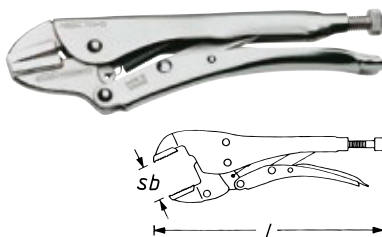

HAZET No.	l mm	sb mm	EAN-No. 4000896+	€
753-10	250	40	030200	33,80

Made in Germany

- Kombinované rozevírání, s jednou otočnou čelistí pro ploché a asymetrický materiál
- Povrch: niklováno

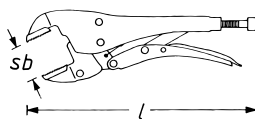

HAZET No.	l mm	sb mm	sb mm	EAN-No. 4000896+	€
753-10 S	250	45	16–45	030217	45,95

758 Skřipcové kleště

Made in Germany

- Čelisti z temperované litiny – extrémně žáruvzdorné – obzvlášť odolné proti usazování okují

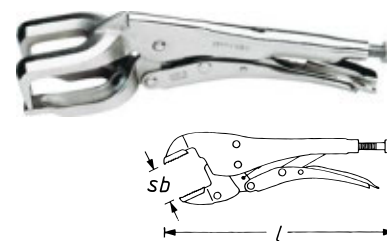

- Páka pro rychlé odjištění
- Úhel čelistí 90°
- Povrch: niklováno

HAZET No.	l mm	sb mm	sb mm	EAN-No. 4000896+	€
758-1	280	51	35–70	030361	51,80

Made in Germany

- Páka pro rychlé odjištění
- Povrch: niklováno



HAZET No.	l mm	sb mm	st mm	EAN-No. 4000896+	€
758-2	280	90	95–77	030378	58,-

755 Skřipcové kleště · samonastavovací

- Ovládání jednou rukou a automatické nastavení
- Variabilní nastavení svěrné síly
- Jednoduché a bezpečné odjištění – kleště zůstanou zavřené, dokud je stisknutý odjišťovací mechanismus
- Vačkový mechanismus – zaručuje automatické nastavení na jakoukoli velikost se zachováním konstantní svěrné síly
- Odšťihovač drátu
- Protiskluzový povrch

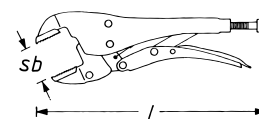
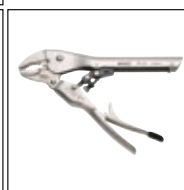

HAZET No.	l mm	sb mm	EAN-No. 4000896+	€
755- 6 A	161	0–32	126569	47,90
755- 7 A	192	0–44	126576	52,15
755-10 A	230	0–44	126590	55,30



752 Skřípcové kleště

- Díky úzkému tvaru se hodí zejména pro práci na zaoblení
- Upínací síla v axiálním směru
- Páka pro rychlé odjištění
- Povrch: leštěný zinek
- Pro práci na U-profilech a svarech v záhybu

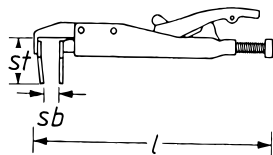
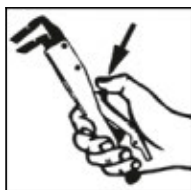

HAZET No.	l mm	sb mm	b mm	st mm	EAN-No. 4000896+	€
752-2	205	15	18	18	030125	52,15

798 Kleště na hadicové spony

- Použití: Jednoduché hadicové spony např. u mycích strojů
- Otočné čelisti – pro stísněné prostorové podmínky
- Povrch: chromováno



HAZET No.	l mm	sb mm	EAN-No. 4000896+	€
798	206	40	031832	40,15

798 Kleště na hadicové spony

- Aretace, nastavitelné rozevření



- Použití: Jednoduché hadicové spony
- Otočné čelisti – pro stísněné prostorové podmínky
- Povrch: chromováno



HAZET No.	l mm	sb mm	EAN-No. 4000896+	€
798-1	285	45	031900	76,55

798 Kleště na hadicové spony Clic

Made in Germany



- Použití: Opětovně použitelné hadicové spony typu CLIC na vedeních paliva
- Např. u VW · AUDI · OPEL · PEUGEOT a ALFA
- Odjištění a uzavření spony otočením kleští o 180°
- Pevné čelisti, zahnuté o 90°

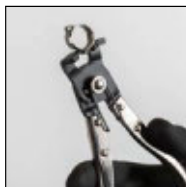

YouTube Clip

HAZET No.	l mm	sb mm	EAN-No. 4000896+	€
798-2	175	20	051397	54,95

798 Kleště na hadicové spony

Made in Germany



- Použití: Manipulace s opakovaně použitelnými hadicovými sponami typu Clic
- AUDI · VW · OPEL · PEUGEOT · SMART a MERCEDES-BENZ
- Odjištění a uzavření otočením kleští o 180°
- Otočné čelisti – pro stísněné prostorové podmínky
- Povrch: niklováno

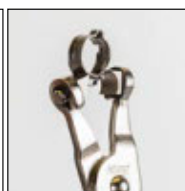

HAZET No.	l mm	sb mm	EAN-No. 4000896+	€
798-3	206	35	102433	55,95

Made in Germany



- Použití: Samoupínací pružné upínací spony
- Otočné čelisti – pro stísněné prostorové podmínky

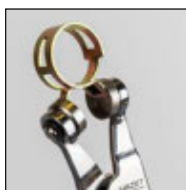

HAZET No.	l mm	sb mm	EAN-No. 4000896+	€
798-4	205	35	031948	56,15



Ruční nářadí

Kleště



798 Kleště na hadicové spony

Made in Germany

- Použití: Pro pružné upínací spony např. na VW, AUDI a OPEL
- Otočné čelisti – pro stísněné prostorové podmínky



HAZET No.	l mm	sb mm	EAN-No. 4000896+	€
798-5	210	6-40	031955	44,60

Made in Germany

- Použití: Pro pružné upínací spony 12 a 15 mm široké, 13 – 22 mm Ø
- Otočné bezpečnostní čelisti

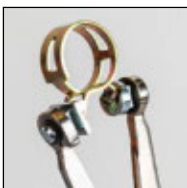

YouTube Clip

HAZET No.	l mm	sb mm	EAN-No. 4000896+	€
798-6	235	39	031962	92,40

Made in Germany

- Práce bez vynaložení velké síly také na velkých pružných sponách díky samonastavitelnému kloubu



- Použití: Pro samoupínací pružné spony 12 a 15 mm široké
- Aretace
- Samonastavitelný kloub
- Otočné bezpečnostní čelisti
- Rukojeť s povrchovou úpravou máčením

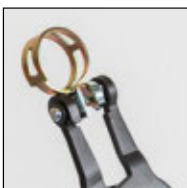

HAZET No.	l mm	sb mm	EAN-No. 4000896+	€
798-8	290	45	076697	103,70

798 Kleště na hadicové spony

Made in Germany

- Aretace



- Použití: Zejména pro pružné upínací spony o šířce 12 a 15 mm, např. u systému chlazení a vytápění
- Otočné čelisti, zahnuté v úhlu 110° – pro stísněné prostorové podmínky
- Rukojeť s povrchovou úpravou máčením

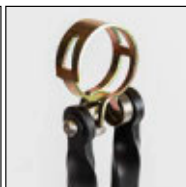

YouTube Clip

HAZET No.	l mm	sb mm	EAN-No. 4000896+	€
798-9	250	60	072163	79,30

Made in Germany

- Aretace



- Použití: Pro spony pružinových pásů – zejména pro pružné upínací spony o šířce 12 mm a 15 mm, např. u vozidel OPEL, VW, FORD, RENAULT, FIAT, PEUGEOT, CITROËN, PORSCHE, ALFA-ROMEO, MERCEDES-BENZ, SMART

- Nastavitelné rozsvěření
- Pevné čelisti



HAZET No.	l mm	sb mm	EAN-No. 4000896+	€
798-10	320	90	031917	146,90

Made in Germany

- Aretace



- Použití: Samoupínací pružné upínací spony
- Nastavitelné rozsvěření
- Rukojeť s povrchovou úpravou máčením

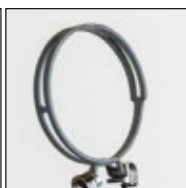

HAZET No.	l mm	sb mm	EAN-No. 4000896+	€
798-12	320	80	031931	161,70



798 Kleště na hadicové spony

Made in Germany

• Použití i ve stísněných prostorech, u kterých nelze na objímku dosáhnout přímo

• Použití: Manipulace s pružnými svorkami, jejichž tři konce leží přímo na hadici, např. na hadicích pro odvětrání nádrže a benzinových hadicích na VW, AUDI, SEAT a ŠKODA

• Otočné čelisti – pro stísněné prostorové podmínky



HAZET No.	l mm	sb mm	EAN-No. 4000896+	€
798-13	192	27	155248	65,30

Made in Germany

• Použití: Manipulace s pružinovými pásovými sponami, jejichž tři konce jsou přímo u hadice
• Např. u benzinových hadic a hadic pro odvětrání nádrže u VW · AUDI · SEAT · ŠKODA
• Povrch: niklováno



HAZET No.	l mm	sb mm	EAN-No. 4000896+	€
798-14	177	8–20	109128	52,55

Made in Germany

• Díky lanovodu (610 mm) lze používat i ve velmi úzkém prostoru, který nedovoluje přímé použití kleští

• Použití: Manipulace se samonapínacími pružnými upínacími sponami a sponami k úspoře místa sb Ø 7–60 mm, např. v oblasti chladicích a topných systémů

• Snadné ovládání díky automatické vícenásobné aretaci

• Posuvné vedení s integrovanou napínací pružinou a nastavitelnou oboustrannou deskou

• Rukojeť s povrchovou úpravou máčením



798 Kleště na hadicové spony

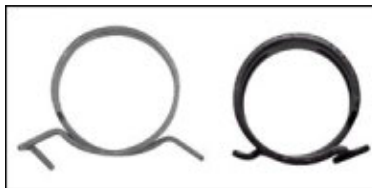

HAZET No.	l mm	sb mm	EAN-No. 4000896+	€
798-15 A	875	7–60	097258	151,60
• Lankové táhlo · kompletní Lankové táhlo · opláštění · 2 stavěcí šrouby · pružina pro 798-15 A				
798-0151 A	–	–	097753	39,20
• Lankové táhlo pro 798-15 A a B				
798-0152 A	–	–	097760	14,50
• Posuvné vedení pro 798-15 A a B				
798-0153 A	–	–	097784	21,60

Made in Germany

• Vhodné zejména ve velmi stísněném prostoru, kde není možné přímé použití kleští

• Použití: Ovládání samopínacích pružinových a prostorově úsporných svorek v oblasti chladicího a topného systému

• Pláštěm opláštěné, polopružné bowdenové táhlo

• Bowdenové táhlo umožňuje práci bez vedení rukou

• Posuvné vedení s integrovanou napínací pružinou a nastavitelnou oboustrannou deskou

• Snadné ovládání díky automatické vícenásobné aretaci

• Rukojeť s povrchovou úpravou máčením



HAZET No.	l mm	sb mm	EAN-No. 4000896+	€
798-15 B	875	7–60	117727	170,20
• Flexibilní hadice pro 798-15 B				
798-0150 B	–	–	142439	47,90
• Lankové táhlo pro 798-15 A a B				
798-0152 A	–	–	097760	14,50
• Posuvné vedení pro 798-15 A a B				
798-0153 A	–	–	097784	21,60



Ruční nářadí

Kleště



798 Kleště na hadicové spony

Made in Germany



• **Zesílené bowdenové táhlo a posuvné vedení**

- Použití: **Speciální spona s paralelně ležícím koncem spony** např. u hrdla chladiče plicního vzduchu u **VW Passat** nebo **T5**
- Bowdenové táhlo lze používat i ve stísněných prostorech
- Vícenásobná aretace a ovládání jednou rukou
- Uvolnění aretačního zařízení pomocí tlačné páčky v oblasti úchopu
- Rukojeť s povrchovou úpravou máčením



HAZET No.	l mm	sb mm	EAN-No. 4000896+	€
798-16	875	3-50	149032	157,70
• Lankové táhlo pro 798-16				
798-0162	-	-	149056	10,35
• Posuvné vedení pro 798-16				
798-0163	-	-	149063	48,60

798 Kleště na hadicové spony

Made in Germany



- Použití: Manipulace se samoupínacími **prostorově úspornými sponami** na hadicích chlazení a u palivových hadic v celém prostoru vozidla, zejména u **VW, AUDI, SEAT, ŠKODA**
- **Otočné čelisti** – pro stísněné prostorové podmínky

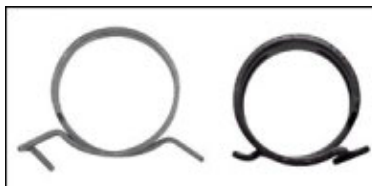

HAZET No.	l mm	sb mm	EAN-No. 4000896+	€
798-17	210	40	186068	47,10

798 Sada kleští na hadicové spony

Made in Germany

- **Safety-Insert-System**, 2komponentní vložka z měkké pěny.
- Vložka vhodná také pro HAZET-Assistent

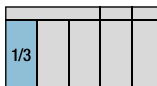

HAZET No.	d x š mm	l mm		EAN-No. 4000896+	€
798					
798-3 • 798-13 • 798-17					
163-425/3	342x172	342	3	202614	149,-

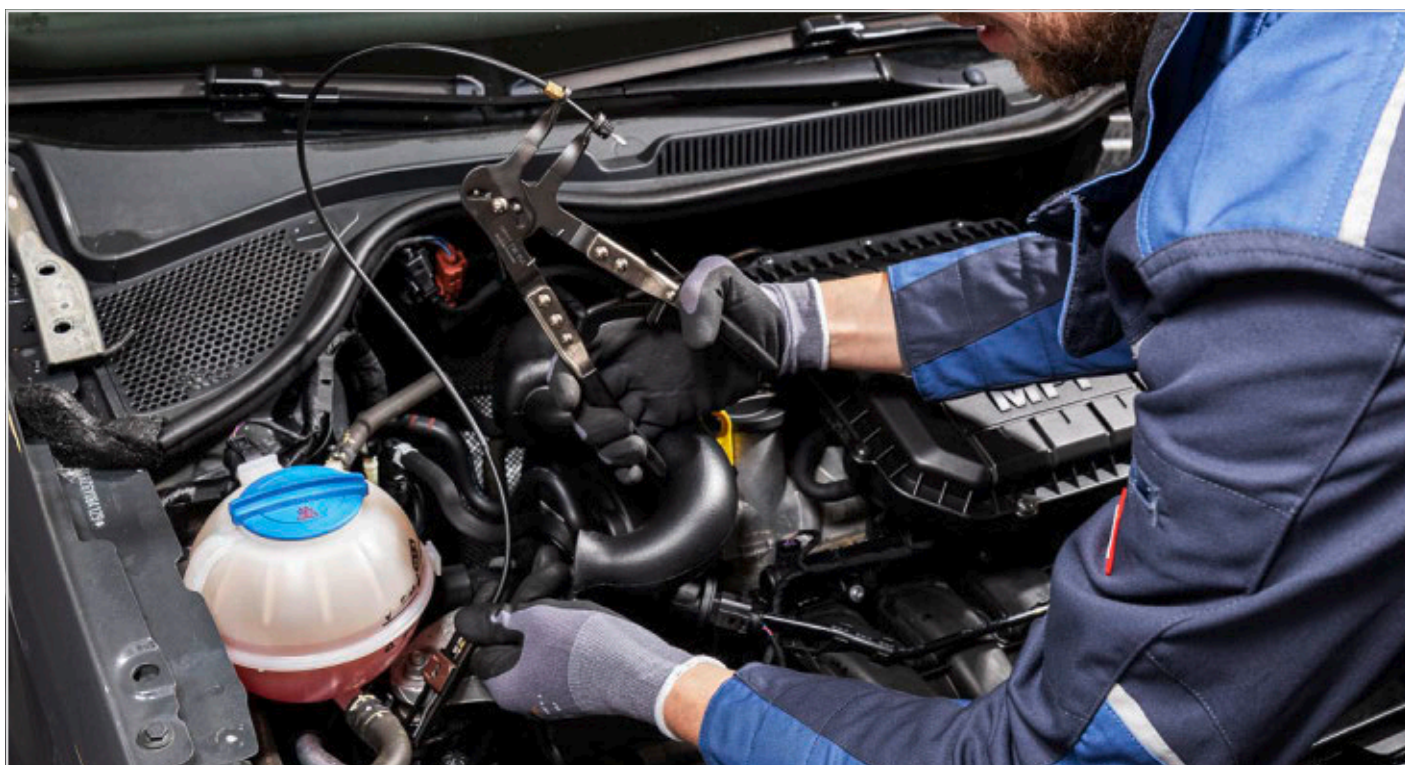



Kladivo HAZET

Vyšší bezpečnost na pracovišti!

BluGuard:



Ocelový ochranný kryt násady Maximální ochrana před zlomením násady při chybných úderech

Ergonomická násada z hikorového dřeva

Dolní konec držadla je nalakovaný černou barvou. Optimalizuje úchop

Pinne & Bahn

Výbrus obou konců kladiva je definován normou DIN 1193. Dráha (plochý konec) je rovná a po obvodu zkosená. Nos kladiva je rovnoměrně zakulacený a po stranách zkosený

Vyražená norma DIN 1041 a údaj o hmotnosti

Zakončení kruhového klínu a oka kladiva v jedné rovině

Zaklínění



Vyšší pevnost v ohybu díky stabilizačnímu okraji kolem dokola

Ocelový ochranný kryt násady: vyšší bezpečnost výrobku HAZET

- Maximální ochrana před zlomením násady při chybných úderech
- Vyšší pevnost v ohybu díky zahnutému stabilizačnímu okraji kolem dokola
- Ocelový ochranný kryt násady HAZET zaručuje maximální ochranu při chybných úderech



BluGuard: Ochranný ocelový kryt násady HAZET po chybném úderu:

- žádné deformace, → jen malé škrábance
- velmi přesné usazení



Násada bez ocelového ochranného krytu:

- výrazně viditelná poškození násady
- zkrácení životnosti a zvýšené nebezpečí prasknutí

BluGuard:

Made in Germany



Ruční nářadí

Kladiva/sekáče/důlčíky



Zámečnické kladivo
BluGuard:



Kladivo



Zámečnické kladivo, anglické



Palička
BluGuard:



Plastové šetrné kladívko



Plastové kladívko



Gumové kladivo



Měděné kladivo

Násady ze dřeva bílého jasanu zaručují vyšší bezpečnost – Proč?

- Třikrát až čtyřikrát vyšší odolnost proti zatížení oproti standardním násadám z jasanového dřeva
- Struktura dřeva s dlouhými vlákny: násada drží pohromadě i při poškození, což zajišťuje výrazně větší bezpečnost při zlomení násady
- Hlavy kladiva při stárnutí dřevěné násady neodletí
- Tlumí vibrace, extrémně pevné v ohybu a trvanlivé



Násada ze dřeva bílého jasanu
Hikorové dřevo drží díky svým dlouhým vláknům násadu pohromadě i v případě, že se násada zlomí.

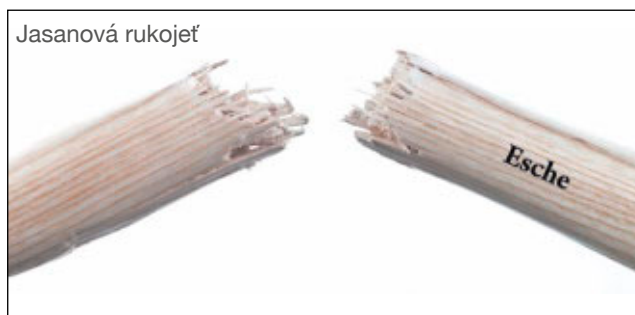



2140 Zámečnické kladivo BluGuard

Made in Germany

- Třída jakosti A
- **Ocelový ochranný kryt násady – Extra bezpečné řešení od firmy HAZET**
 - Maximální ochrana před zlomením násady při chybných úderech
 - Vyšší pevnost v ohybu díky stabilizačnímu okraji kolem dokola
 - Ocelový ochranný kryt násady HAZET zaručuje maximální ochranu při chybných úderech
- Násada z hikorového dřeva
- S ochranným pouzdem násady
- DIN 1041



360°



BluGuard



HAZET No.		l mm	EAN-No. 4000896+	€
2140- 20	200 g	280	196135	23,10
2140- 30	300 g	300	196142	26,05
2140- 40	400 g	310	196159	28,10
2140- 50	500 g	320	196166	30,65
2140- 80	800 g	350	196173	40,20
2140-100	1000 g	360	196180	45,45

2142 Palice BluGuard

Made in Germany

- **Ocelový ochranný kryt násady – Extra bezpečné řešení od firmy HAZET**
 - Maximální ochrana před zlomením násady při chybných úderech
 - Vyšší pevnost v ohybu díky stabilizačnímu okraji kolem dokola
 - Ocelový ochranný kryt násady HAZET zaručuje maximální ochranu při chybných úderech
- Násada z hikorového dřeva
- S ochranným pouzdem násady
- DIN 6475



BluGuard



HAZET No.		l mm	EAN-No. 4000896+	€
2142-1	1000 g	260	196227	33,95
2142-2	1250 g	260	196234	35,85
2142-3	1500 g	280	196241	38,45
2142-4	2000 g	300	196258	43,90

2139 Kladivo

Made in Germany

- Obzvláště bezpečné díky dvojitému zaklínování (1 kruhový klín + 1 dřevěný klín)
- Násada z hikorového dřeva
- DIN 1042



2139 Kladivo

HAZET No.		l mm	EAN-No. 4000896+	€
2139-1	3000 g	600	196197	58,70
2139-2	5000 g	800	196203	82,50

2141 Zámečnické kladivo · anglický tvar

Made in Germany

- Kulatá ploška a kulička
- Násada z hikorového dřeva



HAZET No.		l mm	EAN-No. 4000896+	€
2141-4	2 lbs	380	012787	49,35

1953 Plastové kladivo

Made in Germany

- **Bez zpětného rázu:** díky výplni střední části hlavy kladiva kovovými kuličkami a přesně sladěnému materiálu úderových hlav
- Vyměnitelné hlavy z polyuretanu, netřísťivé a nedrolivé
- Šetrné k materiálu
- Vysoká odolnost vůči oděru s dlouhými dobami upotřebitelnosti
- Rukojeť z PVC odolná vůči oleji a benzínu



HAZET No.	l mm	Ø mm	Délka hlavy kladiva	EAN-No. 4000896+	€
1953 N-30	295	30	110	227075	43,70
1953 N-35	300	35	110	227068	46,25
1953 N-40	305	40	115	227051	53,45
1953 N-50	315	50	120	227044	66,80
1953 N-60	335	60	145	227037	107,90

1953 Náhradní hlava

Made in Germany

- Polyuretan, netřísťivé a nedrolivé
- Opatřované hlavy vytvořte pomocí svěráku
- Nové hlavy narazte několika rázy kladivem



HAZET No.	Ø mm	EAN-No. 4000896+	€
Náhradní hlavy (pár) pro plastové šetrné kladívko HAZET 1953 N-30			
1953 N-030	30	227167	11,30
Náhradní hlavy (pár) pro plastové šetrné kladívko HAZET 1953 N-35			
1953 N-035	35	227150	13,10
Náhradní hlavy (pár) pro plastové šetrné kladívko HAZET 1953 N-40			
1953 N-040	40	227792	15,95
Náhradní hlavy (pár) pro plastové šetrné kladívko HAZET 1953 N-50			
1953 N-050	50	227785	20,40
Náhradní hlavy (pár) pro plastové šetrné kladívko HAZET 1953 N-60			
1953 N-060	60	227778	33,80



1952 Plastová palice

Made in Germany

- Vyměnitelné hlavy z materiálu Desmopan® z malým zpětným rázem
- Ergonomická rukojeť, šetrná ke kloubům
- Střední část ze zinkového tlakového odlitku s vodícím a ochranným pouzdem pro násadu
- Násada s jasanového dřeva



HAZET No.	l mm	Ø mm	EAN-No. 4000896+	€
1952-28	269	28	008506	27,20
1952-35	290	35	008520	32,10
1952-40	317	40	008544	38,55
1952-50	342	50	008551	51,80

1952 Náhradní hlava

Made in Germany

- Z mimořádně tuhého materiálu Desmopan®
- Opatřované hlavy odstraníte silným otočením doleva.
- Nové hlavy narazíte bez otáčení rázem nebo tlakem



HAZET No.	Ø mm	EAN-No. 4000896+	€
• Náhradní hlavy · pár pro plastové šetrné kladívko HAZET 1952-28			
1952-028	28	008391	5,65
• Náhradní hlavy · pár pro plastové šetrné kladívko HAZET 1952-35			
1952-035	35	008414	7,75
• Náhradní hlavy · pár pro plastové šetrné kladívko HAZET 1952-40			
1952-040	40	008438	10,05
• Náhradní hlavy · pár pro plastové šetrné kladívko HAZET 1952-50			
1952-050	50	008452	14,25

2143 Gumové kladivo

Made in Germany

- Z houževnaté pryže (90 Shore), nepružící, se silným účinkem rázu
- Násada s jasanového dřeva
- DIN 5128



HAZET No.	l mm	Ø mm	EAN-No. 4000896+	€
2143	320	54	012794	14,45
2143-1	340	64	196265	11,25

1951 Plastové kladivo · bez zpětného rázu

Made in Germany

- Vyměnitelné hlavy z nárazuvzdorného acetátu celulózy
- Bez zpětného rázu
- Násada s jasanového dřeva



1951 Plastové kladivo · bez zpětného rázu

HAZET No.	l mm	Ø mm	EAN-No. 4000896+	€
1951-27	265	27	196326	10,25
1951-32	280	32	196333	13,50
1951-40	320	40	196357	18,25

2144 Měděné kladivo

Made in Germany

- Násada z hikorového dřeva



HAZET No.	l mm	EAN-No. 4000896+	€	
2144-1	750 g	330	196289	78,95
2144-2	1000 g	350	196296	104,-
2144-3	1500 g	360	196302	142,40
2144-4	2000 g	400	196319	185,30

2132 Ruční sekera

Made in Germany

- Snadné proniknutí do dřeva díky speciálně leštěnému břitu (lamelová brusná technika)
- Protiskluzový konec rukojeti

- Hlava nářadí a dřevěná násada s trojím bezpečnostním zaklínováním (2132-600 s dvojitým zaklínováním)
- Vysoce kvalitní nástrojová ocel C60 (2135-3000: nástrojová ocel C45)
- Originál USA Hickory dřevěná násada, ergonomicky tvarovaná
- Protiskluzová komfortní rukojeť
- Univerzálně použitelná při práci na zahradě a v lese
- Délka (násada): 360 mm
- Použitelná také jako kuchyňská sekera



HAZET No.	EAN-No. 4000896+	€
2132-600	231140	26,75

2133 Sekera na dřevo

Made in Germany

- Snadné proniknutí do dřeva díky speciálně leštěnému břitu (lamelová brusná technika)
- Protiskluzový konec rukojeti

- Hlava nářadí a dřevěná násada s trojím bezpečnostním zaklínováním (2132-600 s dvojitým zaklínováním)
- Vysoce kvalitní nástrojová ocel C60 (2135-3000: nástrojová ocel C45)
- Originál USA Hickory dřevěná násada, ergonomicky tvarovaná
- Protiskluzová komfortní rukojeť
- Délka (násada): 700 mm
- Rázový ochranný kryt ke zvýšení životnosti při chybných úderech



HAZET No.	EAN-No. 4000896+	€
2133-1250	231133	51,40



2134 Štípací sekera

Made in Germany

- Snadné proniknutí do dřeva díky speciálně leštěnému břítu (lamelová brusná technika)
- Protiskluzový konec rukojeti

- Hlava nářadí a dřevěná násada s trojím bezpečnostním zaklínováním (2132-600 s dvojitým zaklínováním)
- Vysoce kvalitní nástrojová ocel C60 (2135-3000: nástrojová ocel C45)
- Originál USA Hickory dřevěná násada, ergonomicky tvarovaná
- Protiskluzová komfortní rukojeť
- Účinné štípaní díky optimalizovanému tvaru hlavy
- Duté kované rozpěrné klíny zabraňují sevření sekery ve dřevu
- Délka (násada): 500 mm
- Rázový ochranný kryt ke zvýšení životnosti při chybných úderech
- Ochrana proti pořezání z umělé kůže



HAZET No.	EAN-No. 4000896+	€
2134-1250	229529	54,50

2135 Štípací kladivo

Made in Germany

- Snadné proniknutí do dřeva díky speciálně leštěnému břítu (lamelová brusná technika)
- Protiskluzový konec rukojeti

- Hlava nářadí a dřevěná násada s trojím bezpečnostním zaklínováním (2132-600 s dvojitým zaklínováním)
- Vysoce kvalitní nástrojová ocel C60 (2135-3000: nástrojová ocel C45)
- Originál USA Hickory dřevěná násada, ergonomicky tvarovaná
- Protiskluzová komfortní rukojeť
- Vykovaná otočná špička ke snadnému vytažení nebo otáčení kusů dřeva
- Délka (násada): 900 mm
- Rázový ochranný kryt ke zvýšení životnosti při chybných úderech
- Ochrana proti pořezání z umělé kůže



HAZET No.	EAN-No. 4000896+	€
2135-3000	231157	60,65

730 Sekáč, plochý

Made in Germany

- Kované provedení
- Průběžně tvrzená podle DIN (54–58 HRC)
- Úderník popuštěný dle DIN (38–46 HRC)
- Broušené bříty nože
- Přebušování bez dodatečného tvrzení
- Plochooávný dřík
- Povrch: lakováno máčením
- DIN 6453



HAZET No.	l mm	mm	EAN-No. 4000896+	€
730-2	125	15	029563	10,15
730-3	150	18	029570	12,10
730-5	175	21	029594	16,25
730-6	200	24	029600	19,65
730-7	250	25	029617	27,85
730-8	300	26	029624	33,75

730 HS Ochrana rukou

Made in Germany



HAZET No.	EAN-No. 4000896+	€
730 HS	029631	8,75

731 Sekáč, plochý

Made in Germany

- Kované provedení
- Průběžně tvrzená podle DIN (54–58 HRC)
- Úderník popuštěný dle DIN (38–46 HRC)
- Broušené bříty nože
- Přebušování bez dodatečného tvrzení
- Osmihranný dřík
- Povrch: lakováno máčením



HAZET No.	l mm	mm	EAN-No. 4000896+	€
731-2	125	11	029648	8,65
731-5	150	15	029655	11,50

740 Křížový sekáč

Made in Germany

- Kované provedení
- Průběžně tvrzená podle DIN (54–58 HRC)
- Úderník popuštěný dle DIN (38–46 HRC)
- Broušené bříty nože
- Přebušování bez dodatečného tvrzení
- Plochooávný dřík
- Povrch: lakováno máčením
- DIN 6451



HAZET No.	l mm	mm	EAN-No. 4000896+	€
740-3	150	6	029679	11,50

741 Křížový sekáč

Made in Germany

- Kované provedení
- Průběžně tvrzená podle DIN (54–58 HRC)
- Úderník popuštěný dle DIN (38–46 HRC)
- Broušené bříty nože
- Přebušování bez dodatečného tvrzení
- Osmihranný dřík
- Povrch: lakováno máčením



HAZET No.	l mm	mm	EAN-No. 4000896+	€
741-1	125	4	029709	8,70



Ruční nářadí

Kladiva/sekáče/důlčíky



745 Průbojník

- Made in Germany**
- Osmihranný dřík
- Povrch: matná černá
- DIN 6458



HAZET No.	l mm	Ø mm	EAN-No. 4000896+	€
745-1	120	1	029716	6,85
745-2	120	2	029723	6,85
745-3	120	3	029730	6,85

745 A Průbojník

- Made in Germany**
- Těžké provedení (D)
- Osmihranný dřík



HAZET No.	l mm	Ø mm	EAN-No. 4000896+	€
745 a-2	120	2	029778	8,45
745 a-3	120	3	029785	8,45
745 a-4	120	4	029792	8,45
745 a-5	120	5	029808	8,45
745 a-6	120	6	029815	8,45

746 Důlčik

- Made in Germany**
- Osmihranný dřík
- DIN 7250



HAZET No.	l mm	Ø mm	EAN-No. 4000896+	€
746-1	120	10	029846	6,80
746-2	120	13	029853	8,40

750 Sada sekáč · průbojník · důlčik

- Made in Germany**



HAZET No.	ks	EAN-No. 4000896+	€
750 731-2 • 731-5 • 741-1 • 745-3 • 745 a-4 • 746-1	6	030026	40,10
750 730-3 • 730-6 • 740-3 • 745-2 • 745 a-4 • 746-2	6	030033	60,65

747 Důlkovač · samočinný

- Made in Germany**
- Plynule nastavitelná síla úderu od 3 do 30 kg
- Tvrký hrot důlčiku (vyměnitelný)
- Dlouhá životnost
- Síla úderu se uvolní jednoduchým lehkým stlačením horního dílu
- Rýhovaná rukojeť



HAZET No.	l mm	EAN-No. 4000896+	€
747-1	135	051434	40,10
747-02	-	051380	18,70

748 A Vytloukač závlaček

- Made in Germany**
- Osmihranný dřík
- DIN 6450 tvar C



+ = Dlouhé provedení

HAZET No.	l mm	Ø mm	EAN-No. 4000896+	€
748 a- 2	115	2	029884	10,40
748 a- 3	125	3	029891	10,40
748 b- 2	150	2	029907	11,10
748 b- 3	150	3	029914	11,10
748 b- 4	150	4	029921	11,10
748 b- 5	150	5	029938	11,10
748 b- 6	150	6	029945	11,10
748 b- 8	150	8	029952	12,-
748 c- 6 +	180	6	029976	12,50
748 c- 8 +	200	8	029983	13,80
748 c-10 +	200	10	029969	14,45

748 LGB Vytloukač závlaček

- Made in Germany**
- Dlouhé provedení



HAZET No.	l mm	Ø mm	EAN-No. 4000896+	€
748 Lg b-3	175	3	100040	12,-
748 Lg b-4	175	4	029990	12,-

751 Sada vytloukačů závlaček

- Made in Germany**



HAZET No.	ks	EAN-No. 4000896+	€
751 748 a-2 • 748 a-3 • 748 b-4 • 748 b-5 • 748 c-6 • 748 c-8	6	030088	40,10
751 748 b-2 • 748 b-3 • 748 b-4 • 748 b-5 • 748 b-6 • 748 b-8	6	030095	40,10



751 KHS Vytlačkač závlaček · krátký

Made in Germany

- Krátké provedení s ochranou ruky
- 2komponentní rukojeť s ochranou rukou



HAZET No.	l_1 mm	l_2 mm	Ø mm	EAN-No. 4000896+	€
751 K HS-3	10	109	3	159987	10,40
751 K HS-4	10	109	4	159994	10,40

751 HS Sada vytlačkačů závlaček

Made in Germany

- Ergonomická 2komponentní ochrana rukou zaručena:
 - Výrazné snížení rizika zranění
 - Tlumivý účinek (snížení zatížení rukou při úderech)
 - Bezpečné držení

Obsah:

- 5 3 · 4 · 5 · 6 · 8 mm
- 2komponentní rukojeť s ochranou rukou
- DIN 6450 tvar C
- Délka chrániče ruky: 75 mm



HAZET No.	l_1 mm	l_2 mm		EAN-No. 4000896+	€
751 HS/5	75	150	5	148257	49,15

751 LHS Sada vytlačkačů závlaček · dlouhé

Made in Germany

- Ergonomická 2komponentní ochrana rukou zaručena:
 - Výrazné snížení rizika zranění
 - Tlumivý účinek (snížení zatížení rukou při úderech)
 - Bezpečné držení

Obsah:

- 5 3 · 4 · 5 · 6 · 8 mm
- 2komponentní rukojeť s ochranou rukou
- DIN 6450 tvar C
- Délka chrániče ruky: 85 mm



HAZET No.	l_1 mm	l_2 mm		EAN-No. 4000896+	€
751 L HS/5	90	175	5	205530	46,55

2534 Mosazný trn

Made in Germany



HAZET No.	l mm	Ø mm	EAN-No. 4000896+	€
2534	200	20	016365	29,-

2164 Sada silových pák

- Ploché, zešíkmené hroty pro použití i ve stísněných prostorech
- Masivní čtyřhranné čepel pro vysoký přenos sil

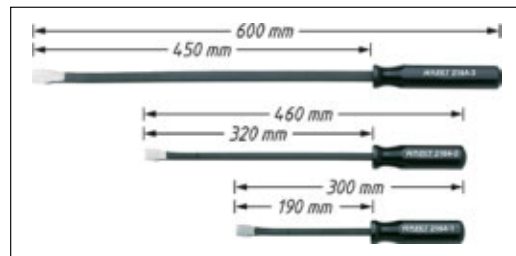

HAZET No.		EAN-No. 4000896+	€
2164/3	3	080281	122,60

2165 Montážní páka

Made in Germany

- Povrch: leštěný zinek



HAZET No.	l mm	EAN-No. 4000896+	€
2165-1	400	013302	53,10
2165-2	400	013319	36,60
2165-3	400	013326	63,75

2166 Železná páka s dvojitou rukojetí pro užitková vozidla

- Nárazuvzdorná ergonomická plastová rukojeť koncipovaná pro práci obouřuč
- Průběžná 6hranná čepel
- Masivní úderová hlava pro vysoké namáhání
- Tvrdené, zušlechťené



HAZET No.	l mm	EAN-No. 4000896+	€
2166-4	1116	161072	186,50



3ramenný stahovák HAZET

Snadné použití díky novému rychlému otočnému/stahovacímu systému



- ① Precizně vyrobená hlava zaručuje rychlé a přesné použití
- ② Bezúdržbová uzavřená mechanika
- ③ Schopnost vysokého tlačného zatížení vřetene a tažného zatížení háků díky kvalitní oceli a termochemické úpravě
- ④ Flexibilní, vyměnitelný hrot umožňuje univerzální použití

Made in Germany

Jednoduchým otáčivým pohybem se hák otevře a automaticky sevře stahovaný díl i při svislém použití (odpadá dodatečné seřizování)

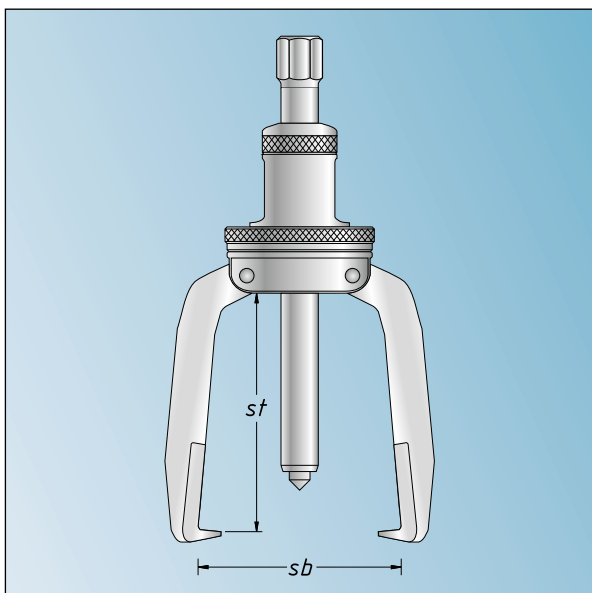



2ramenný stahovák HAZET

S rychloupínáním

- Pro rychlé a bezpečné stažení kuličkových ložisek, přírub, kol apod.

- ① V zápustce **kované** háky a traverzy
- ② Rychlé a bezproblémové nastavení a seřízení ručně ovládaným **rychloupínáním**
- ③ Použití jako **vnější a vnitřní stahovák** díky snadnému přepnutí háků
- ④ Nitridované vřeteno –
Velmi tvrdé!
Bezúdržbové –
není nutné mazání
- ⑤ **Stupnice pro nastavení** umožňující rovnoměrné seřízení stahovacích háků

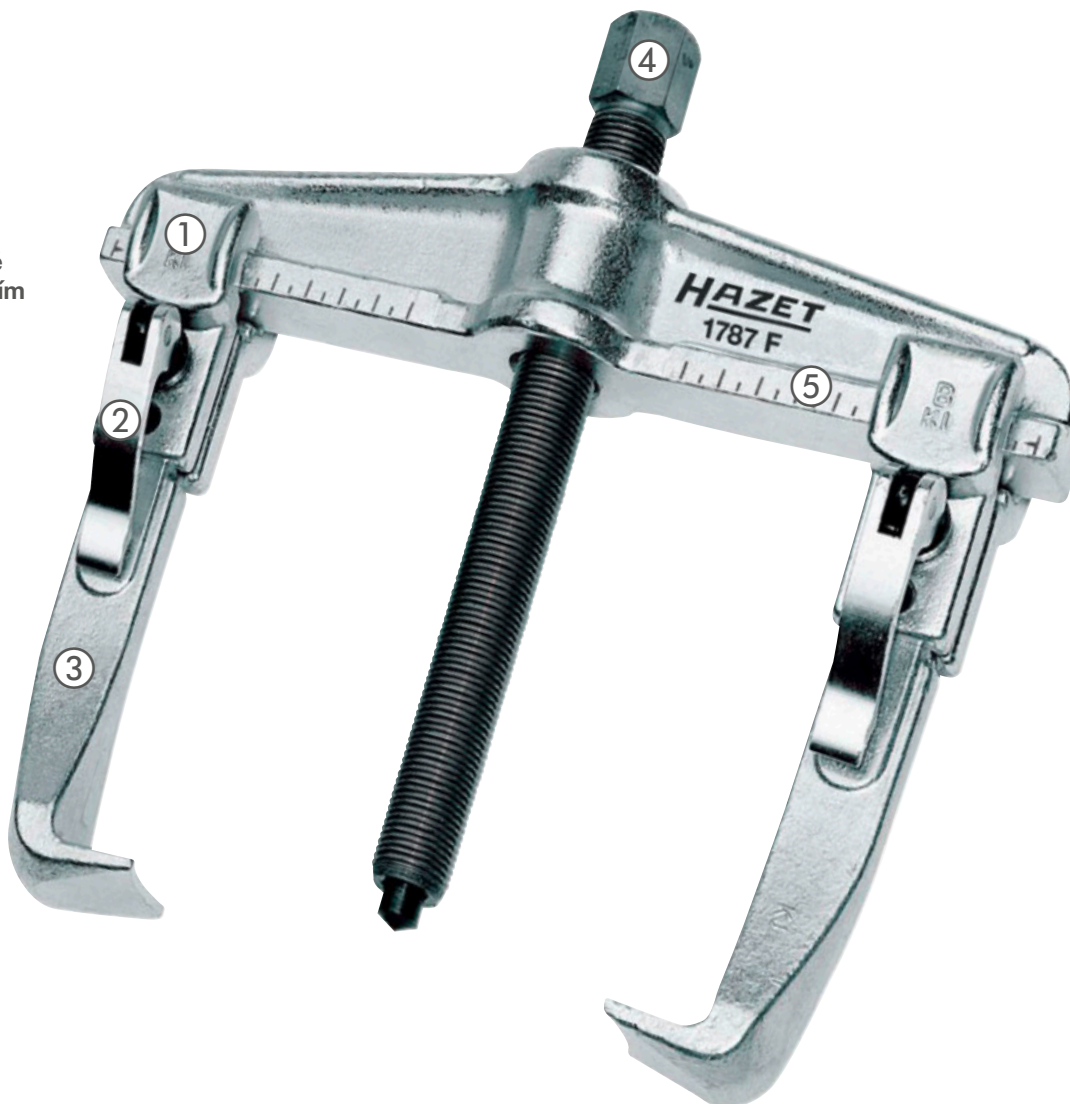

Made in Germany

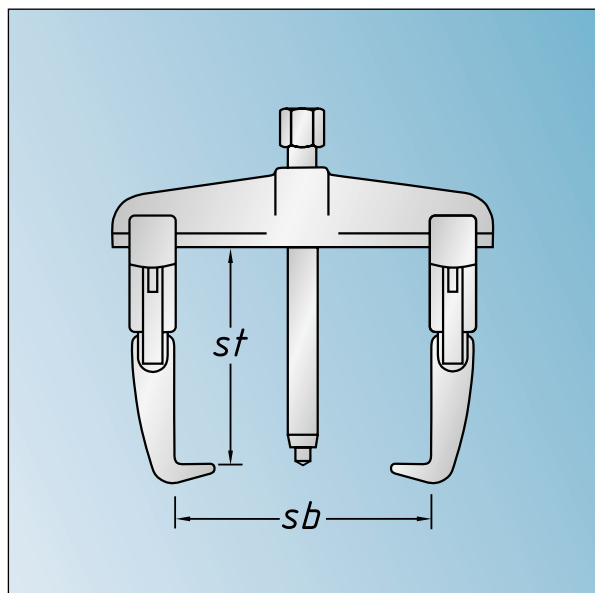



Stahovák 1 x 1

Najděte vždy ten správný stahovák

Vnější stahovák HAZET

Nejčastějším způsobem stahování je stahování zvenčí, tzn. stahovaný díl (kuličkové ložisko, řemenice, ozubené kolo atd.) se uchopí a stáhne z vnější strany. Vlastní proces stahování se provádí ovládáním vřetená.

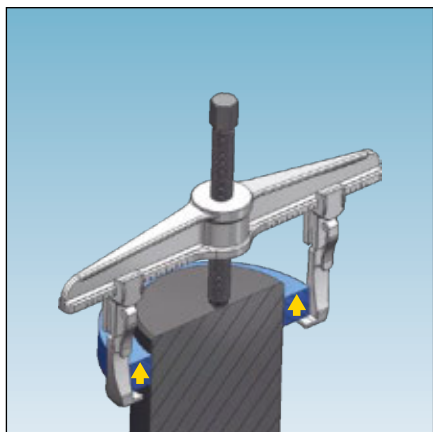

Vnější stahovák HAZET ve standardním provedení

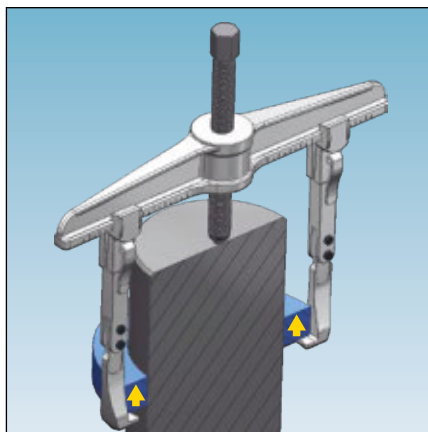

Vnější stahovák HAZET s dlouhým stahovacím hákem

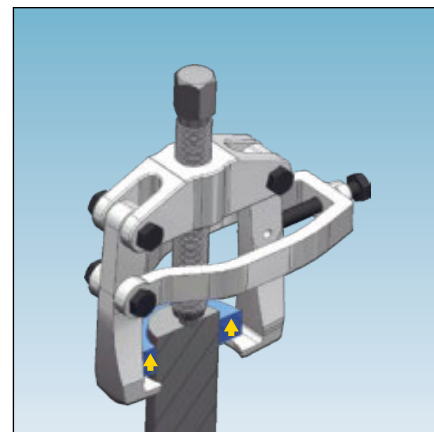

Vnější stahovák HAZET s bočním upínacím svěrákem

Vnější stahovák HAZET použitelný i jako vnitřní stahovák

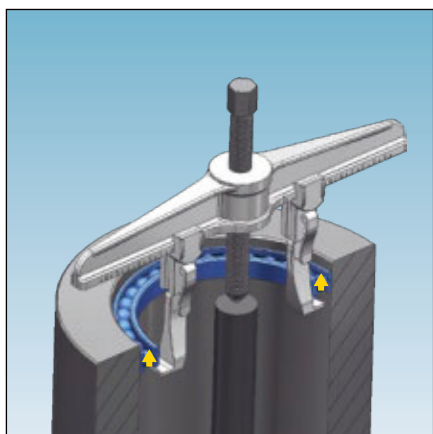

Použití stahováků sérií HAZET č. 1787 F 9-35, 1787-52, 1787 S-1 a 2, 1783-22 **jednoduchým otáčením stahovacích háků** na traverze také jako vnitřní stahovák. Předpokladem je hřídel uprostřed dílu, o který se vřetená opře.

Vnitřní stahovák HAZET

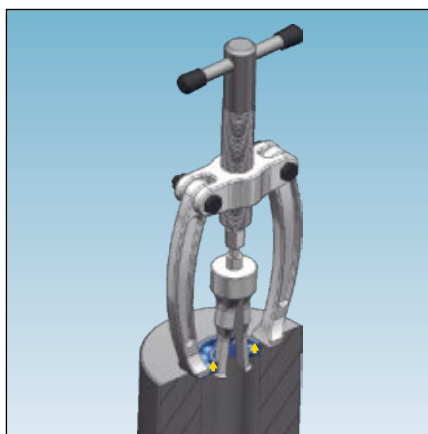

Standardně se při této aplikaci používá vnitřní stahovák a vzpěra.

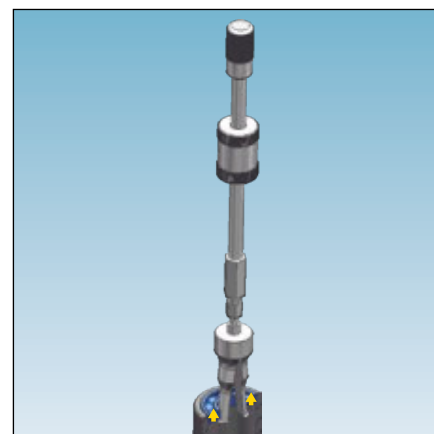

Při nedostatku místa lze upustit od použití podpěry a může se použít kluzné vyťahovací kladiwo.

Příklady použití stahováků se speciálním nářadím

- V průmyslu, u komponentů pro motorová a užitková vozidla
- Ovládací páka na sloupku řízení
- Kulové klouby, kuličková ložiska, destičky, kola
- Ozubená kola, pastorky



Stahovák 1 x 1

Najděte vždy ten správný stahovák

Dělicí a stahovací přípravky HAZET

Pokud nelze použít standardní vnější stahovák, např. u plošně dosedajících dílů, existuje možnost využití takzvaného dělicího stahováku

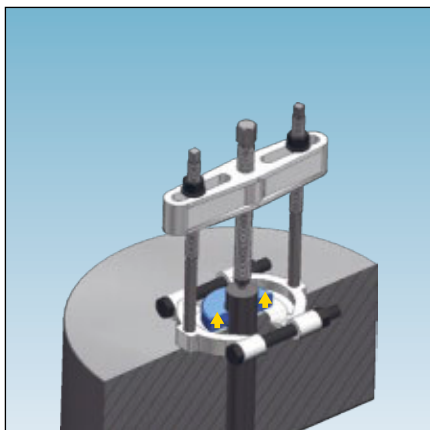

Standardně se při této aplikaci používá dělicí přípravek, v kombinaci se stahovacím přípravkem.

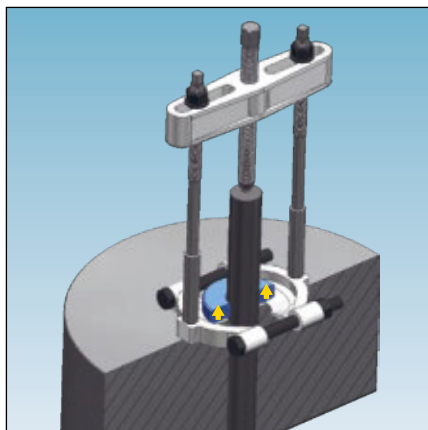

Pro stahování delších hřídelí lze stahovací přípravek prodloužit.

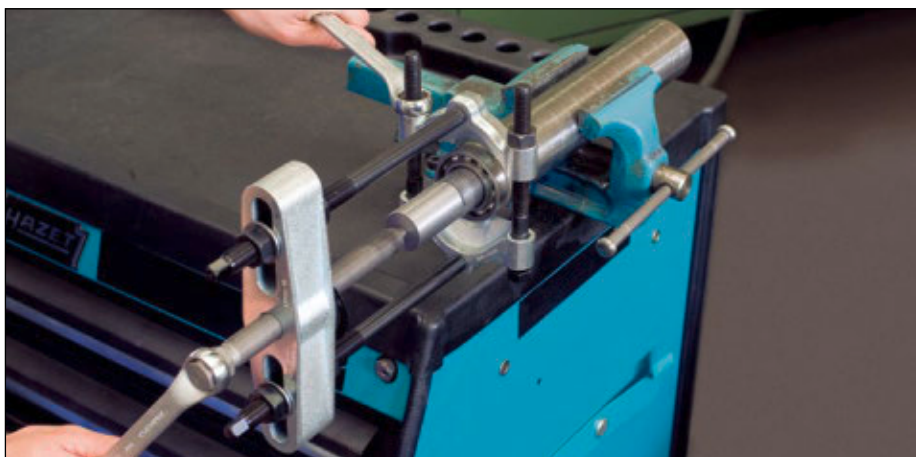

Stahovák ložisek HAZET

Pokud se ložiska nacházejí na hřídeli a ve skříni, používá se stahovák ložisek HAZET.

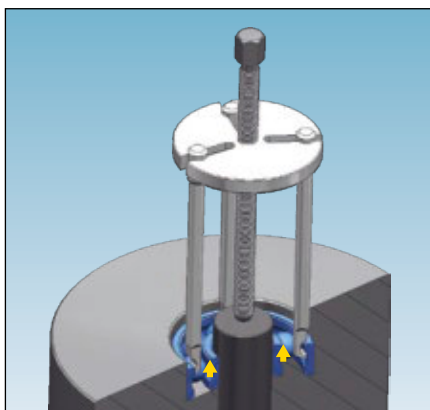

HAZET č. 1778-3/40 zasahuje do klece ložiska

Průmyslová ložiska





Ruční nářadí

Stahovák, 2ramenný



Stahovák, 2ramenný

1787 F Rychloupínací stahovák · 2ramenný

Made in Germany

• Rychloupínání

- Nitridované vřeteno – velmi tvrdé
- Bezúdržbové – není nutný žádný olej
- Použití jako vnější i vnitřní stahovák pomocí jednoduchého přestavení háků
- Rychlé, bezproblémové nastavení a přizpůsobení díky rychloupínání
- Masivní stahovák kovaný v záпустce
- Nastavovací stupnice pro stejnoměrné usazení tažných háků

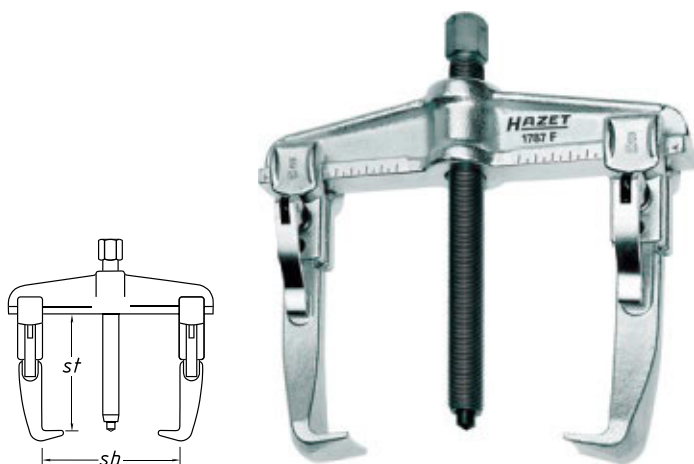

HAZET No.	Max. t	sb mm	st mm	Vřeteno	EAN-No. 4000896+	€
1787 F- 9	3	90	100	M 14x1,5x140 mm	134151	112,50
1787 F-13	3	130	100	M 14x1,5x140 mm	134168	112,80
1787 F-16	5	160	150	G 1/2"x210 mm	134175	163,40
1787 F-20	5	200	150	G 1/2"x210 mm	134182	171,80
1787 F-25	7,5	250	200	G 3/4"x280 mm	134199	281,80
1787 F-35	7,5	350	200	G 3/4"x280 mm	136094	311,80

1787 Stahovák · 2ramenný

Made in Germany

- Stahovací hák lze po přesazení použít jako vnitřní a vnější stahovák
- Vřeteno G1 x 310
- Povrch: zinkováno

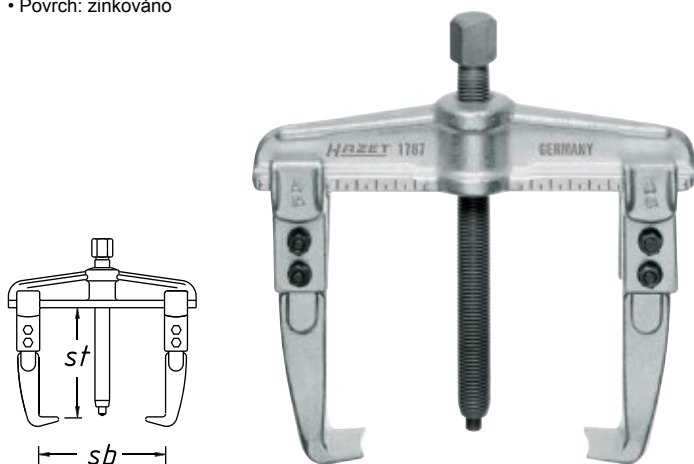

HAZET No.	Max. t	sb mm	st mm	EAN-No. 4000896+	€
1787-52	10	520	208	136100	428,80

1787 F Sada rychloupínacích stahováků · 2ramenných

Made in Germany

- Rychloupínání
- Dvouramenný stahovák
- Do prodejního stojanu



1787 F
1787 F-9 · 1787 F-13 · 1787 F-16
1787 F-20 · 1787 F-25



HAZET No.		EAN-No. 4000896+	€
1787 F/5	5	133017	842,-

1787 S Sada stahováků · 2ramenných

Made in Germany

- Úzké háky
- „3 v 1“
- 6 úzkých kovaných háků ve 3 dvojicích různých délek
- Pro práci ve stísněných prostorech

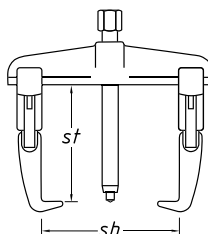

HAZET No.	sb mm	st mm	EAN-No. 4000896+	€
1787 S-1	130	100-200-250	133222	312,90

1783 Univerzální stahovák · 2ramenný

Made in Germany

- Oboustranně použitelné stahovací háky s jednou úzkou stranou pro použití ve stísněných prostorech

- Použití: Stahování ozubených kol a kuličkových ložisek
- Samočinné přitlačení stahovacích háků
- Provedení se 2 rameny
- Povrch: zinkováno

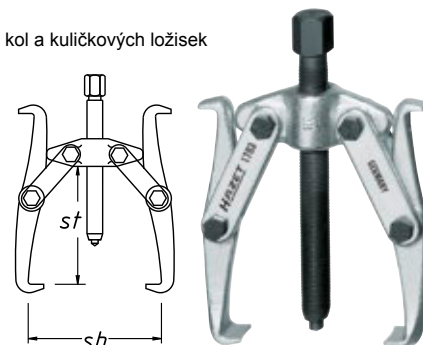

HAZET No.	Max. t	sb mm	st mm	Vřeteno	EAN-No. 4000896+	€
1783-22	5	220	170	M 18x1,5x170 mm	136063	130,-



1792 Stahovák na větráky · 2ramenný

Made in Germany

- 2ramenný
- Speciální, štíhlé stahovací háky s trojitým přestavením hloubky upnutí
- Robustní a kované provedení

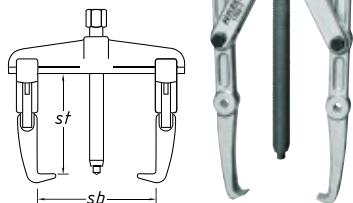

HAZET No.	Max. t	sb mm	st mm	Vřeteno	EAN-No. 4000896+	€
1792-1	2	150	200	M 14x1,5x155 mm	147830	105,70

1776 Stahovák hlavní páky řízení · 2ramenný

Made in Germany

- Pro kuličková ložiska, ozubená kola, pastorky, páky bloku řízení a podobné díly
- Upínací svěrka přitlačí stahovací háky pevně na stanovené díly
- Povrch: zinkováno

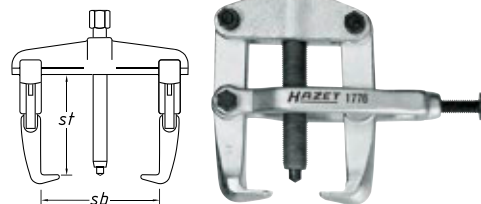

HAZET No.	sb mm	st mm	Vřeteno	EAN-No. 4000896+	€
1776-85	90	85	M18x1,5x130 mm	135943	172,80
1776-100	90	100	M18x1,5x130 mm	135950	155,10
1776-140	150	140	G ½"x175 mm	135967	252,40

Stahovák, 3ramenný

1785 Stahovák · 3ramenný

Made in Germany

- Snadné použití díky rychlému „otočnému/stahovacímu systému“
- Precizně vyrobená hlava zaručuje rychlé a přesné použití
- Schopnost vysokého tlačného zatížení vřeteno a tažného zatížení háků díky kvalitní oceli a termochemické úpravě
- Flexibilní, vyměnitelný hrot umožňuje univerzální použití
- Jednoduchým otáčivým pohybem se hák otevře a automaticky sevře stahovaný díl i při svislém použití (odpadá dodatečné seřizování)
- Bezúdržbová uzavřená mechanika

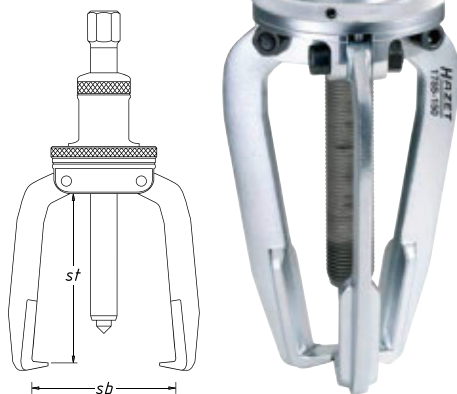

HAZET No.	Max. t	sb mm	st mm	Vřeteno	EAN-No. 4000896+	€
1785-150	6,5	150	130	G ½"x250 mm	133154	364,30
1785-250	6,5	250	250	G ½"x350 mm	133161	521,-



1786 F Rychloupínací stahovák · 3ramenný

Made in Germany

- Rychloupínání
- Zaručuje rovnoměrné rozdělení zatížení, bezpečné uchopení a vystředěnou práci
- Nitrovaná vřeteno – velmi tvrdé
- Bezúdržbové – není nutný žádný olej

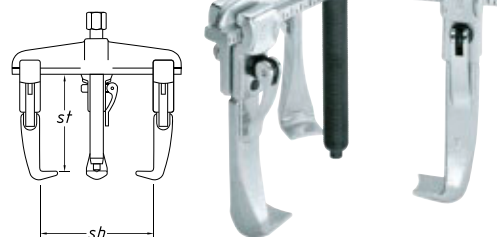

HAZET No.	Max. t	sb mm	st mm	Vřeteno	EAN-No. 4000896+	€
1786 F-13	3	130	100	M 14x1,5x140 mm	133529	171,90
1786 F-16	5	160	150	G ½"x210 mm	133536	213,40
1786 F-20	5	200	150	G ½"x210 mm	133567	233,80
1786 F-25	7,5	250	200	G ¾"x280 mm	133574	402,50

1786 S Sada stahováků · 3ramenných

Made in Germany

- Úzké háky
- „3 v 1“
- 9 úzkých kovaných háků ve 3 dvojicích různých délek
- Pro práci ve stísněných prostorech
- 3ramenný, po 3 háčích
- Zaručuje rovnoměrné zatížení, bezpečné uchopení a vystředěnou práci

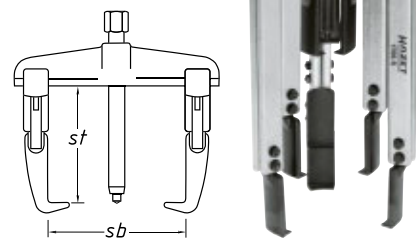

HAZET No.	sb mm	st mm	EAN-No. 4000896+	€
1786 S-1	130	100-200-250	133246	469,20



Ruční nářadí

Komponenty stahováků



1786 FS Sada rychloupínacích stahováků

Made in Germany

- Se 3 háky
- Ideální základní sada s fixační pákou
- Použití jako vnější a vnitřní stahovák díky snadnému přepnutí háků
- Úzká ramena háků nutná zejména při opravách převodovek (běžné stahovací háky nelze z prostorových důvodů použít)
- Plastová skříňka
- Vložka z měkké pěny



HAZET No.	sb mm	st mm	Vřeteno		EAN-No. 4000896+	€
• Sada rychloupínacích stahováků, obsah: 1786-01 1786-21 · 31 1786 FS-100 (3x)						
1786 FS/6	90	100	M 14x1,5x140 mm	6	133871	221,30

1786 S Sada stahováků · 3ramenných

Made in Germany

- S 9 háky
- Rozsáhlá sada pro všechny běžné šířky a hloubky upnutí (100–250 mm)
- Plastová skříňka
- Vložka z měkké pěny



HAZET No.	sb mm	st mm		EAN-No. 4000896+	€
• Sada stahováků, obsah: 1786-01 1786-2 · 3 1786 S-100 (3x) · 1786 S-200 (3x) · 1786 S-250 (3x)					
1786 S/12	120	100–200–250	12	133888	546,-

1789 Univerzální stahovák · 3ramenný

Made in Germany

- Oboustranně použitelné stahovací háky s jednou úzkou stranou pro použití ve stísněných prostorech
- Použití: Stahování ozubených kol a kuličkových ložisek
- Samočinné přitlačení stahovacích háků
- Provedení se 3 rameny
- Povrch: zinkováno



1789 Univerzální stahovák · 3ramenný

HAZET No.	Max. t	sb mm	st mm	Vřeteno	EAN-No. 4000896+	€
1789-9	3	90	80	M 14x1,5x125 mm	147427	93,20
1789-16	5	160	130	M 18x1,5x170 mm	136070	146,30
1789-22	5	220	170	M 18x1,5x170 mm	136087	173,30
1789-32	12	320	260	G 1/2"x350 mm	147731	327,70
1789-40	12	400	320	G 1/2"x350 mm	147748	330,90

1785 Stahovák pólových a bateriových svorek · 3ramenný

Made in Germany

- Snadno ovladatelné, robustní provedení s kovanými háky
- Použití: Stahování malých dílů jako např. svorek baterií, kulových ložisek, podložek, kol atd.
- Samočinné přitlačení háků
- Provedení se 3 rameny



HAZET No.	Max. t	sb mm	st mm	Vřeteno	EAN-No. 4000896+	€
1785-60	0,8	60	60	M 10x1,5x80 mm	133338	49,45

Komponenty stahováků

1787 F Stahovací háky s rychloupínáním

Made in Germany

- Po kusu
- Pro stahováky 1786 F a 1787 F



HAZET No.	st mm	EAN-No. 4000896+	€
• Pro 1786 F-9 · 13 • 1787 F-9 · 13			
1787 F-0913	100	136117	36,05
• Pro 1786 F-16 · 20 • 1787 F-16 · 20			
1787 F-1620	150	136124	54,50
• Pro 1786 F-25 · 35 • 1787 F-25 · 35 • 1787-52			
1787 F-2552	200	136131	87,15

1787 Stahovací háky bez rychloupínání

Made in Germany

- Po kusu
- Pro stahováky
1786 F-25 · 35
1787 F-25 · 35
1787-52



HAZET No.	st mm		EAN-No. 4000896+	€
1787-2552	200	–	136148	84,40
1787 Lg-0913	200	–	136155	40,65
1787 Lg-1620	300	–	136162	68,60
1787 Lg-2552	305	–	136179	112,70
1787 Lg-2552/4	406	4	136186	136,70
1787 Lg-2552/5	504	5	136193	142,90



1786 S Stahovací hák · úzký

Made in Germany

- Po kusu
- Pro stahovky 1786 S-1 a S-2, jakož i 1787 S-1 a S-2



HAZET No.	sť mm	EAN-No. 4000896+	€
Stahovací hák (100 mm) Pro HAZET 1786 S-1 · 1787 S-1 · 1786S/12			
1786 S-100	100	134762	48,35
Stahovací hák (150 mm) Pro HAZET 1786 S-1 · 1787 S-1 · 1786S/12			
1786 S-150	150	134816	79,05
Stahovací hák (200 mm) Pro HAZET 1786 S-1 · 1787 S-1 · 1786S/12			
1786 S-200	200	134779	61,60
Stahovací hák (220 mm) Pro HAZET 1786 S-1 · 1787 S-1 · 1786S/12			
1786 S-220	220	134823	98,55
Stahovací hák (250 mm) Pro HAZET 1786 S-1 · 1787 S-1 · 1786S/12			
1786 S-250	250	134786	66,75
Stahovací hák (300 mm) Pro HAZET 1786 S-1 · 1787 S-1 · 1786S/12			
1786 S-300	300	134830	98,65

Dělicí přípravek

1775 N Dělicí přípravek

Made in Germany

- Upnutí dělicího přípravku probíhá stejnomořným utahováním matic na podpěrných čepích
- Povrch: zinkováno/mořeno



HAZET No.	Ø mm	M	EAN-No. 4000896+	€
1775 N- 60	5–60	M10	135936	68,40
1775 N- 75	12–75	M10	134540	86,20
1775 N-115	22–115	M14x1,5	134656	127,10

1775 N Stahovací přípravek

Made in Germany

- Použití: Stahování kuličkových a válečkových ložisek a vnitřních kroužků
- Ve spojení s dělicím přípravkem HAZET 1775 N-60 · 75 · 115 se tažné čepy šroubují do závitových děr oddělovacích čelistí
- Povrch: zinkováno/mořeno



HAZET No.	s _b mm	Vřeteno	Tažný čep	EAN-No. 4000896+	€
1775 N-12	40–120	M 14x120 mm	M 10	134922	76,20
1775 N-16	60–165	M 15x170 mm	M 10	134588	96,95
1775 N-21	70–215	G ½"x210 mm	M 14x1,5	134618	143,80

1775 N Prodloužení

Made in Germany

- Pro pár
- Povrch: mořeno, olejováno
- Pro 1775 N-12 a -16



HAZET No.	l mm	M	EAN-No. 4000896+	€
1775 N-012	100	M10	134366	14,80

1775 N Sada dělicích a stahovacích přípravků

Made in Germany

- Pro stíněné prostory a licující ložiska

- Dělicí a stahovací přípravky s prodloužením
- Tažné čepy ve spojení s dělicím přípravkem se šroubují do závitových děr oddělovacích čelistí
- Upnutí dělicího přípravku probíhá stejnomořným utahováním matic na podpěrných čepích
- Kovová schránka (modrá HAZET)



HAZET No.	s _b mm	M	EAN-No. 4000896+	€
1775 N 1775 N-16 · 1775 N-75 · 1775 N-012				
1775 N/4	60–165	4	133208	264,70
1775 N 1775 N-21 · 1775 N-115				
1775 N-1/4	70–215	4	133215	357,70

1780 Dělicí a stahovací vidlice

Made in Germany

- Osvědčený a cenově výhodný systém

- Použití: Rychlé ovládní hlav hlavní tyče řízení a spojovací tyče řízení, hlavních pák řízení a ostatních řídicích dílů díky klínové vidlici
- Jednoduchá manipulace
- Demontáž tlumičů a jiné oddělovací práce
- Oddělovací vidlici lze použít i v nejtěsnějších prostorech
- Robustní, kované provedení

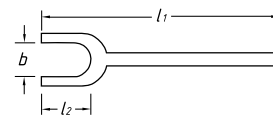

HAZET No.	l ₁ mm	l ₂ mm	b mm	EAN-No. 4000896+	€
1780-18	340	80	18	133345	51,95
1780-23	340	80	23	133352	55,70
1780-29	350	80	29	133376	58,15



Ruční nářadí

Vytahovák, vnitřní



Vytahovák, vnitřní

1788 N Vytahovák, vnitřní

Made in Germany

- Použití: Vytahování kuličkových ložisek, vnějších kroužků kuličkových ložisek a pouzder
- Společně s podpěrným zařízením 1788 N-835 a 4570
- + = Zesílený pás – bezproblémové a bezpečné stahování jehlových ložisek, kuličkových ložisek a také mosazných pouzder



HAZET No.	Ø mm	M	EAN-No. 4000896+	€
1788 N-12 +	12-14	M10	147694	70,35
1788 N-14 +	14-19	M10	147700	73,35
1788 N-15	12-15	M10	134861	51,50
1788 N-19	15-19	M10	134878	54,05
1788 N-25	19-25	M10	134885	55,10
1788 N-30	25-30	M10	134892	57,50
1788 N-35	30-35	M10	134915	64,65
1788 N-45	35-45	M14x1,5	134502	79,05
1788 N-55	45-55	M14x1,5	136209	176,50
1788 N-70	55-70	M14x1,5	136216	239,-

1788 N Opěrné přípravky

Made in Germany

- Pro vnitřní vytahovák HAZET 1788 N-12 až -70
- Povrch: chromováno



HAZET No.	Vřeteno	EAN-No. 4000896+	€
• Pro vnitřní vytahovák 1788 N-12 až 35			
1788 N- 835	M 10 mm	134854	78,70
• Pro vnitřní vytahovák 1788 N-45 až 55			
1788 N-4570	M 14x1,5 mm	134908	104,90

1788 N Sada vnitřních vytahováků

Made in Germany

- Vytahování kuličkových ložisek, vnějších kroužků kuličkových ložisek a pouzder
- Vnitřní vytahovák a opěra
- Kovová schránka (modrá HAZET)



1788 N Sada vnitřních vytahováků

HAZET No.	□	EAN-No. 4000896+	€
1788 N			
1788 N-835 • 1788 N-4570 • 1788 N-15 • 1788 N-19			
1788 N-25 • 1788 N-30 • 1788 N-35 • 1788 N-45			
1788 N/8	8	133185	633,-
1788 N			
1788 N-835 • 1788 N-4570 • 1788 N-15 • 1788 N-19 • 1788 N-25			
1788 N-30 • 1788 N-35 • 1788 N-45 • 1788 N-55 • 1788 N-70			
1788 N/10	10	147939	1049,-

1788 T Sada vnitřních vytahováků

Made in Germany

- Titanem nitrídaný povrch extra tvrdý a odolný vůči opotřebení
- Pro těsně doléhající kuličková ložiska, kroužky, pouzdra a simerinky®
- Flexibilní materiál
- Zlepšený přenos síly díky absolutně precizní výrobní přesnosti
- Snadná manipulace
- Pouhé 4 vnitřní vytahováků pokrývají rozsah od 5 do 36 mm
- Použitelné s kluzným vytahovacím kladivem nebo opěrou
- Atraktivní sestava
- Lepší povrchová ochrana, odolná vůči vysokým teplotám, díky kalenému titanem nitrídanému povrchu, který je odolnější vůči opotřebení
- Použití
 - Zavést vnitřní vytahovák do ložiska a zašroubovat vřeteno
 - Ostré koncové patky se přitlačí na vytahovaný díl ze zadu
 - Nasazení kluzného kladiva nebo opěry
 - Plastová skříňka



HAZET No.	M	l mm	□	EAN-No. 4000896+	€
• Sada vnitřních vytahováků, obsah:					
1788 T-1 • 1788 T-8.5					
1788 T-15 • 24 • 36					
1788 T/5	-	-	5	133666	373,80
• Rázový vytahovací přístroj (kluzné kladivo – kluzná hmotnost 200 g) s přípojným závitem M 10					
• Vytahování krytů s vnitřním závitem, kuličkovým ložiskem, kotouči atd.					
• Ve spojení se sadou závitových čepů 1788 T-1/6 a vnitřním vytahovákem 1788 N-15 do 35					
• Také ve spojení se stahovákem vstříkovačů 4797-5					
1788 T-1	M10	226	-	134304	27,90

1788 T Sada závitových svorníků

Made in Germany

- Použití: Vytažení různých krytů s vnitřním závitem
- 6dílná sada, závitové čepy s přípojovacím závitem M 10, obsah: Po 1 kusu nasazovacího závitu M 4, M 5, M 6, M 8, M 10, M 12
- Použití s kluzným kladivem 1788 T-1



HAZET No.	□	EAN-No. 4000896+	€
1788 T-1/6	6	141647	60,70



1788 T Rázový vytahovací přístroj

Made in Germany

- Použití: Demontáž pevně usazených vstříkovačů Common-Rail bez demontáže hlavy válců



HAZET No.	M	l mm	EAN-No. 4000896+	€
• Rázový vytahovací přístroj (kluzné kladiwo – kluzná hmotnost 200 g) s přípojným závitem M 10				
• Vytahování krytů s vnitřním závitem, kuličkovým ložiskem, kotouči atd.				
• Ve spojení se sadou závitových čepů 1788 T-1/6 a vnitřním vytahovákem 1788 N-15 do 35				
• Také ve spojení se stahovákem vstříkovačů 4797-5				
1788 T-1	M10	226	134304	27,90
Snadné vytahování vstříkovačů ve spojení s rázovým vytahovacím přístrojem např. HAZET 1788 T-1				
• Drapák na vstříkovače s vnitřním závitem M 10 x 1,5 mm				
• MAN motory D08 · D20 · D26 · D28				
• Upravené pro velmi stísněný prostor v hlavě válce				
• Uchopení vstříkovače drapákem v horní části bez poškození				
4797-5	-	174	176137	170,80

1774 Stahovák trámů

Made in Germany

- Kováno v záпустce, zušlechtěné tažné háky

- Použití: Upnutí, tažení, stlačení dřeva
- Stahovák krokvi
- Háky pozinkované, ráčna chromovaná
- Ergonomické – s přepínací ráčnou
- Trapézový závit TR 16x5 s velmi lehkým chodem
- Upínací dráha: 115 mm
- Celková šířka: 440 mm
- Délka ráčny: 275 mm



HAZET No.	EAN-No. 4000896+	€
1774-1	180578	186,40

1778 Sada stahováků kuličkových ložisek

Made in Germany

- Značně jednodušší manipulace než u známých běžných systémů umožňuje ještě vyšší efektivitu a produktivitu

- Použití: Stahování kulových ložisek uložených na jednom hřídeli a v tělese
- Pro více než 40 standardních kuličkových ložisek do velikosti 6311
- Uživatelsky komfortní uchycení stahovacích háků
- 100% přenos síly díky samočinné aretaci

- 40dílná sada
- Pro kuličková ložiska 6000 až 6407

Ložisko	Háky	Úchyt
6000	1778-10	1778-3
6001	1778-10	1778-2
6002	1778-10	1778-1
6003	1778-10	1778-2
6004	1778-30	1778-1
6005	1778-30	1778-1
6006	1778-30	1778-1
6007	1778-40	1778-1
6008	1778-40	1778-1
6009	1778-40	1778-1
6010	1778-40	1778-1
6200	1778-10	1778-2
6201	1778-20	1778-3
6202	1778-20	1778-2
6203	1778-30	1778-2
6204	1778-40	1778-2
6205	1778-40	1778-1
6300	1778-30	1778-1
6301	1778-40	1778-1
6302	1778-40	1778-3
6303	1778-40	1778-3
6304	1778-40	1778-3

Ložisko	Háky	Úchyt
6011	1778-50	1778-4
6012	1778-50	1778-4
6206	1778-50	1778-4
6207	1778-50	1778-4
6208	1778-60	1778-4
6209	1778-60	1778-4
6210	1778-60	1778-4
6211	1778-60	1778-4
6212	1778-70	1778-4
6213	1778-70	1778-6
6305	1778-60	1778-6
6306	1778-60	1778-5
6307	1778-60	1778-5
6308	1778-70	1778-5
6309	1778-70	1778-5
6310	1778-70	1778-5 1)
6311	1778-70	1778-5 2)
6403	1778-60	1778-4
6404	1778-70	1778-4
6405	1778-70	1778-6
6406	1778-70	1778-6
6407	1778-60	1778-6 3)

1) 6310 2) 6311 3) 6309

Upozornění: tato tabulka slouží jako orientační pomůcka při výběru dílů stahováků a nevznášá žádný nárok na správnost a/nebo úplnost



HAZET No.	Úchyt	EAN-No. 4000896+	€
1778-3/40	40	133697	940,-

Nářadí pro stahování kulového kloubu najdete v části
Speciální nářadí → Podvozek → Ložiska kol / náboje kol od strany 434



Brusná, dělicí a obráběcí technika

2128 Kazeta se spirálovými vrtáky

- 25 dílů, Ø 1–13 mm se zvyšováním o 0,5 mm
- HSS
- Úhel špičky 118°
- Zabroušení kuželového pláště
- DIN 338



HAZET No.	EAN-No. 4000896+	€
2128 N-1	218844	79,30

1967 Vrtačka na bodové svary

Germany

- Samořezný středící hrot přebrousitelný

- Rychlořezná ocel, modřená



HAZET No.	l mm	Ø mm	EAN-No. 4000896+	€
1967-70	74	7	009343	24,55
1967-80	79	8	009350	29,20
1967-90	79	9	009367	34,45

1967 Fréza na bodové svary

Germany

- Vhodná pro každou vrtačku
- Šestihránná násada (7 mm) nedochází k překroucení ve sklíčidle
- Vyměnitelná frézovací korunka (pravotočivý závit) z rychlořezné oceli (olejované)
- Korunku lze používat oboustranně
- Nastavení hloubky řezu (*) pomocí stavěcího šroubu



HAZET No.	l mm	Ø mm	EAN-No. 4000896+	€
1967	70	11	009312	35,60
Náhradní korunky, sada po 5 ks, pro 1967				
1967-01/5	–	–	211319	52,40
• Hrot pro frézu svarových bodů HAZET 1967				
1967-02	–	–	009336	3,85

2150 Rýsovací jehla

- Povrch: mořeno, olejováno



HAZET No.	l mm	EAN-No. 4000896+	€
2150	240	013012	7,75

2150 Rýsovací jehla

- Tvrdokov pro dlouhodobé použití
- S upevňovacím úchytem



HAZET No.	l mm	EAN-No. 4000896+	€
2150-1	150	144129	5,05

2119 Půlkulatý pilník

Germany

- Zuby (záseky): 2 = střední
- Plastová rukojeť
- DIN 7261 tvar E

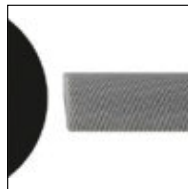

HAZET No.	l mm	EAN-No. 4000896+	€
2119- 8	200	012398	27,65
2119-10	250	012381	36,15

2120 Kulatý pilník

Germany

- Zuby (záseky): 2 = střední
- DIN 7261 tvar F

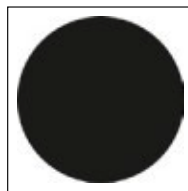

HAZET No.	l mm	EAN-No. 4000896+	€
2120- 8	200	012411	20,15
2120-10	250	012404	26,75

2123 Trojhranný pilník

Germany

- Zuby (záseky): 2 = střední
- DIN 7261 tvar C

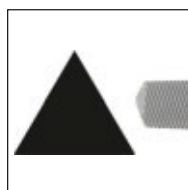

HAZET No.	l mm	EAN-No. 4000896+	€
2123- 8	200	012473	26,55
2123-10	250	012466	35,40



2122 Plochý obdélníkový pilník

Made in Germany

- Zuby (záseky): 2 = střední
- DIN 7261 tvar A

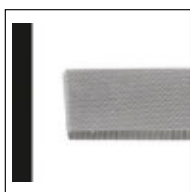

HAZET No.	l mm	EAN-No. 4000896+	€
2122- 8	200	012435	22,15
2122-10	250	012428	27,75

4968 Pilník na brzdové třmeny

Made in Germany

- Jednostranné ozubení zabraňuje poškození prachové manžety na brzdovém pistu

- šířka 12 mm
- Hrubost pilníku: hrubý, jednostranně šikmo ozubený
- Plochá škrabka na čelní straně k odstranění hrubých zbytků nečistot
- Plastová rukojeť

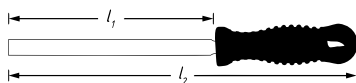

HAZET No.	l ₁ mm	l ₂ mm	EAN-No. 4000896+	€
4968-1	150	260	084739	39,50

Made in Germany

- Extra úzký (šířka 10 mm), zejména vhodný pro japonská vozidla

- Plochá škrabka na čelní straně k odstranění hrubých zbytků nečistot

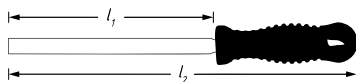

HAZET No.	l ₁ mm	l ₂ mm	EAN-No. 4000896+	€
4968-5	155	265	129379	39,55

Made in Germany

- Extra úzké provedení

- Hranatý pilník na brzdové třmeny
- Velmi dobrá životnost
- 10 x 10 mm
- Plastová rukojeť s otvorem pro zavěšení

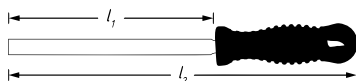

HAZET No.	l ₁ mm	l ₂ mm	EAN-No. 4000896+	€
4968-6	155	265	218431	39,55

824 Škrabka, plochá

Made in Germany

- 824 dlouhá čepel
- 824-1 krátká čepel
- Povrch: zinkováno



824



824-1

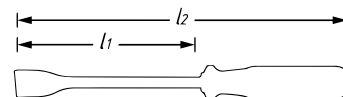

HAZET No.	l ₁ mm	l ₂ mm	± mm	b mm	EAN-No. 4000896+	€
824	150	270	0,5	23	033881	29,50
824-1	55	165	0,5	23	033898	28,05

825 Škrabák, plochý

- Vyměnitelná břitová destička z tvrdokovu



HAZET No.	l ₁ mm	l ₂ mm	± mm	b mm	EAN-No. 4000896+	€
825-25	267	397	0,5	25	033959	99,70
825-025	-	-	-	25	033928	58,70

821 Trojhranná dutá škrabka

Made in Germany

- Hroty zbrošené

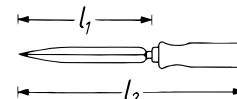

HAZET No.	l ₁ mm	l ₂ mm	EAN-No. 4000896+	€
821-1	150	260	033683	16,85
821-2	200	315	033690	14,30

823 Trojhranná jemná škrabka

Made in Germany

- Ochranný plášť z vysoce odolného a pevně elastického plastu

- S krytkou



HAZET No.	l ₁ mm	l ₂ mm	EAN-No. 4000896+	€
823	25	148	033874	19,55



822 Úhlová škrabka

Made in Germany

• Vyměnitelné bimetálové otočné čepele HSS



- Odškrábání zbytků těsnění, např. na hlavě válce
- Instalace kabelových šachet v cihlách Ytong
- Práce neohrožují životní prostředí:
 - nevytváří se prach
 - nevzniká hluk
 - nevytváří se plynný chlór příp. dioxin (jako např. při upalování)
- Povrch: chromováno

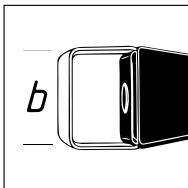

HAZET No.	l mm	b mm	EAN-No. 4000896+	€
• Samostatný držák čepelí 822-01 (plochý)				
822	270	20	033713	50,35
• Sada náhradních břitů pro 822				
5 kusů v sadě				
822-01/5	–	–	033720	32,85

1980 N Pila na kov

- Křídlatý šroub k upnutí pilového listu
- S 1 pilovým listem
- Pro pilové listy 300 mm
- DIN 6494 tvar A



HAZET No.	l mm	EAN-No. 4000896+	€
1980 N	390	009824	40,10
• Pilový list			
• 24 zubů/palec			
• 300 mm délka			
• Jednostranné ozubení			
• Kalený a vysoce elastický			
1980 B-2	300	009817	4,40

1981 Pilka na kov, malá

Made in Germany



- Pro pilové listy 150 mm
- S 1 pilovým listem z chromem legované nástrojové oceli
- Počet zubů/inch: 32 (1 inch/palec = 25,4 mm)
- Rukojeť z plastu vyztuženého skleněnými vlákny
- Speciální ocel – ocel 2 K 40



HAZET No.	l mm	EAN-No. 4000896+	€
1981	252	009831	15,55
• Pilový list z chromem legované nástrojové oceli pro 1981			
• Počet zubů/inch: 32 (1 inch/palec = 25,4 mm)			
1981-01	150	009848	0,70

2158 Univerzální nůžky

• Ergonomické tvarování umožňuje otvírání a zavírání blokování jednou rukou



- Blokování nůžek
- Dodatečně s kulatými břitů k odizolování drátů (1 resp. 1,5 mm²)
- 2komponentní rukojeť HAZET



HAZET No.	l mm	EAN-No. 4000896+	€
2158	194	057856	29,80

2157 Univerzální nůž



- Technický víceúčelový nůž
- Záložní kanál pro náhradní břitů
- 1 oddělovací, trapézový a hákový břit
- Plastový obal vyztužený skleněným vláknem
- Vysunutí a zajištění břitu jednou rukou
- Bezpečné zajištění břitu



HAZET No.	l mm	EAN-No. 4000896+	€
2157	167	013203	11,85
• Odlamovací břitů např. pro univerzální nůž 2157 · 7násobné odlomení 100x18 mm sada po 10 ks			
2157-04	–	013210	10,90
• Trapézové břitů s 2 úchyty · např. pro univerzální nůž 2157 sada po 10 ks			
2157-05	–	013227	14,45
• Hákové břitů · např. pro univerzální nůž 2157 · sada po 10 ks			
2157-06	–	013234	17,65

2157 Nůž, skládací



- Rychlá výměna břitů
- Vč. 5 čepelí
- Komfortní rukojeť z narázuvzdorného ABS
- Příhrádka na čepel s bezpečnostním uzávěrem
- Pošťáček na palec pro práci šetrnou ke kloubům
- Délka v zaklapnutém stavu: 100 mm



360°



HAZET No.	l mm	EAN-No. 4000896+	€
2157-1	159,9	147236	28,50
• Trapézové břitů se 3 úchyty · např. pro 2157-1 sada po 10 ks			
2157-07	–	150977	7,75



2157 Zavírací mininůž

- Rychlá výměna čepelí
- Rychlouzávěr čepelí
- Komfortní rukojeť z ABS
- Uzavření nože stisknutím uvolňovací páčky čepelí s aretací
- Příhrádka na čepel s bezpečnostním uzávěrem
- Vč. 5 náhradních čepelí
- Délka v zaklapnutém stavu: 57 mm



HAZET No.	l mm	EAN-No. 4000896+	€
2157-2	100	164318	18,60
• Náhradní trapézové břity pro zavírací nůž Mini HAZET 2157-2 sada po 10 ks			
2157-08	-	166022	2,75

2157 Zavírací nůž

- Fixace čepelí v otevřeném stavu – již není možné zavření omylem
- Hliníková rukojeť s prohlubněmi pro prsty
- Čepel z vysoce kvalitní nerezové oceli
- Lehká a příručná
- Praktický klip na pásek
- Délka v zaklapnutém stavu: 115 mm



HAZET No.	EAN-No. 4000896+	€
2157-3	231089	12,25

2180 Teleskopická řezačka trubek

- K řezání hliníku, mědi a tenkostěnných kovových trubek

- 4 vodící kolečka pro optimální držení trubky při řezání
- Integrovaná odhroťovací čepel NOGA, kompletně vysouvatelná
- Systém rychlé výměny umožňuje rychlou výměnu řezacího kolečka bez použití nářadí
- Včetně 2 řezacích koleček (2180 N-021): vždy 1 namontováno v hlavě a krytce otočné rukojeti
- Vřeteno uloženo v ocelovém ložisku pro lepší skluz kluznice
- Tělo z magneziového tlakového odlitku
- Kluznice a otočný knoflík ze zinkového tlakového odlitku



HAZET No.	l mm	Ø mm	EAN-No. 4000896+	€
2180 N-2	145	6–35	198986	67,90
• Náhradní řezací kolečko pro 2180 N-2 a 2181 N-1				
2180 N-021	-	-	198993	4,90

4682 Řetězový řezák trubek

- Jednoduché nastavení pomocí křídlového šroubu během řezání

- Použití: **Oddělování např. výfukových trubek** zejména z oceli V2A do tloušťky stěny 2,5 mm a Ø 75 mm
- Větších průměrů řezání lze dosáhnout prodloužením pomocí řetězu 4682-01
- Malé vynaložení síly, zafixováno **technikou uchopení**
- Povrch: niklováno



HAZET No.	l mm	Ø mm	EAN-No. 4000896+	€
4682	255	15–75	022168	159,40
• Náhradní řetěz pro 4682				
4682-01	-	-	022175	78,75
• Sada náhradních dílů · 9-dílná pro opravu řezného řetězu 4682-01 Pro 4682				
4682-01/9	-	-	057214	14,95

- Jednoduché nastavení pomocí křídlového šroubu během řezání

- Použití: **Oddělení trubek** z pozinkované nebo nerezové (V2A) oceli, mědi, PVC a hliníku až do tloušťky stěny 6 mm a Ø 115 mm
- 15 řezacích koleček z legované oceli
- Povrch: niklováno



HAZET No.	l mm	Ø mm	EAN-No. 4000896+	€
4682-1	315	20–115	149384	168,30
• Náhradní řetěz pro 4682-1				
4682-03	-	-	149421	116,90

2181 Řezačka trubek, malá

- Řezání hliníkových, měděných a tenkostěnných kovových trubek

- „Instant Change System (ICS)“ umožňuje rychlou výměnu řezného kolečka bez použití nářadí
- Vřeteno uloženo v ocelovém ložisku pro lepší skluz kluznice
- Extrémně zredukovaný pracovní poloměr
- Vč. 1 řezného kolečka (2180 N-021)
- Ergonomický otočný knoflík pro optimální manipulaci
- Tělo, kluznice a otočný knoflík ze zinkového tlakového odlitku
- Povrch: lakovaný



HAZET No.	l mm	Ø mm	EAN-No. 4000896+	€
2181 N-1	52	3–16	198979	16,25
• Náhradní řezací kolečko pro 2180 N-2 a 2181 N-1				
2180 N-021	-	-	198993	4,90



2130 Drátěný kartáč

Made in Germany
• Odolné drátěné štětiny



- 4řadý
- Výška drátu: 25 mm
- Dřevěné tělo
- Otvor pro zavěšení



HAZET No.	l mm	EAN-No. 4000896+	€
2130	290	012510	4,65

- 4řadý
- Štětiny V2A
- Dřevěné tělo
- Otvor pro zavěšení



HAZET No.	l mm	EAN-No. 4000896+	€
2130-1	280	012527	19,30

2131 Kartáč na zapalovací svíčky

Made in Germany
• Vlnité speciální mosazné drátěné štětiny



- Použití: Čištění elektrod a kontaktů zapalovacích svíček
- 3řadý
- Výška drátu 15 mm
- Dřevěné tělo



HAZET No.	l mm	EAN-No. 4000896+	€
2131	150	012541	3,60

4968 Kartáč na brzdový třmen

Made in Germany
• Úzké provedení



- Použití: Odstranění tvrdého prachu z brzd, špíny na kotoučových brzdových třmenech
- Plastová rukojeť s otvorem pro zavěšení



HAZET No.	l mm	EAN-No. 4000896+	€
4968-2	225	084821	10,50

4968 Mosazný kartáč na brzdový třmen

Made in Germany
• Práce šetrná k materiálům díky měkkým mosazným štětinkám



- Použití: Čištění hliníkových brzdových sedel
- Úzké provedení – pro úzké šachty brzdových sedel
- Plastová rukojeť s otvorem pro zavěšení



HAZET No.	l mm	EAN-No. 4000896+	€
4968-3	225	089147	15,-





Opravy závitů

840 Vytahovák šroubů

Made in Germany

• Broušený



HAZET No.	Ø mm	M	Ø mm	EAN-No. 4000896+	€
840-1	1,4–3,6	3–6	1,8	035687	3,55
840-2	2,1–4,9	6–8	2,6	035694	4,05
840-3	3,1–6,5	8–11	3,7	035700	4,75
840-4	4,8–8,8	11–14	5,5	035717	6,-
840-5	6,2–11	14–18	7	035724	6,85

840 Sada vytahováků šroubů

Made in Germany

• Plastová skříňka



HAZET No.		EAN-No. 4000896+	€
• Sada vytahováků šroubů, obsah: 840-1 · 2 · 3 · 4 · 5			
840/5	5	035762	19,55
• Sada vytahováků šroubů, obsah: 840-1 · 2 · 3 · 4 · 5 · 6 · 7 · 8			
840/8	8	035786	60,65

841 Sada vytahovačů čepů

• Plastová skříňka

• Povrch: mořeno, olejováno

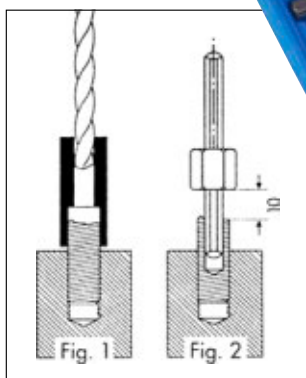

841 Sada vytahovačů čepů

HAZET No.		EAN-No. 4000896+	€
25dílná, v plastovém boxu			
841/25	25	060993	132,60
• Převlečná matice Pro 841/25			
841-01	-	074433	10,75
841-02	-	074440	12,05
841-03	-	074457	12,45
841-04	-	074464	12,85
841-05	-	074471	13,65
• Navrtávací pouzdro Pro 841/25			
841-06	-	074488	11,65
841-07	-	074495	11,65
841-08	-	074501	11,65
841-09	-	074518	11,65
841-010	-	074525	11,65
841-011	-	074532	11,65
841-012	-	074549	11,65
841-013	-	074556	11,65
841-014	-	074563	11,65
841-015	-	074570	11,65
• Vytahovák čepů Pro 841/25			
841-016	-	074587	10,20
841-017	-	074594	12,50
841-018	-	074600	15,10
841-019	-	074617	17,70
841-020	-	074624	28,60

Navrtávací pouzdro	Ø vrtáku mm	Vytahovák čepů	Vhodné pro	
841-06	4	841-016	M 5	3/16"
841-07	4	841-016	M 6	9/32" 1/4"
841-08	4	841-016	M 7	9/32"
841-09	4	841-016	M 8	5/16"
841-010	5	841-017	M 8	5/16"
841-011	5	841-017	M 9	11/32"
841-012	5	841-017	M10	3/8"
841-013	6	841-018	M11	7/16"
841-014	7,5	841-019	M12	15/32"
841-015	8,5	841-020	M14	9/16"

844 Vytahovák podpěrných čepů

Made in Germany

125 1/2

- Pro šetrnou montáž a demontáž závitových stavěcích čepů a závitových kolíků s pravým nebo levým závitem
- □ Pohon 12,5 = 1/2" nebo ≤ 21 mm vnější šestihran
- Povrch: chromováno, leštěno



HAZET No.	l mm	Ø mm	Ø mm	EAN-No. 4000896+	€
844- 6	65	23	6	035823	42,10
844- 7	65	23	7	035830	42,10
844- 8	65	23	8	035847	42,10
844-10	75	27	10	035809	45,10
844-12	75	27	12	035816	45,35



Ruční nářadí

Opravy závitů



844 Sada vyťahovačů podpěrných čepů

Germany **Made in Germany**

- SmartCase (1/9) 165-S
- Safety-Insert-System, 2komponentní vložka z měkké pěny. Vložka vhodná také pro HAZET-Assistent
- Povrch: chromováno, leštěno



844 • 1/9
844-6 • 844-7 • 844-8
844-10 • 844-12



HAZET No.	d x š x v mm		FAN-No. 4000896+	€
844/5	185x153x52	5	035878	163,40

842 AG Univerzální dořezávací závitník

• Pro průměr závitu 4–13 mm (5/32"–1/2")

- Použití: Dořezávání pravých a levých závitů (respektovat směr otáčení)
Všechny metrické a nemetrické druhy závitů (boční míra 60°)
- Rychloupínání pomocí stavěcího šroubu
- Automatické nastavení čepele na libovolné stoupání závitu



HAZET No.	M	FAN-No. 4000896+	€
842 AG-1	4–13 mm / 5/32"–1/2"	140718	54,05

• Pro průměr závitu 16–38 mm (5/8"–1.1/2")

- Použití: Dořezávání pravých a levých závitů (respektovat směr otáčení)
metrické a nemetrické druhy závitů (boční míra 60°)
- Rychloupínání pomocí stavěcího šroubu
- Automatické nastavení čepele na libovolné stoupání závitu



HAZET No.	M	FAN-No. 4000896+	€
842 AG-3	16–38 mm / 5/8"–1.1/2"	149230	198,10

842 AIG Sada univerzálního prořezávače závitů

• Pro vnější závit 4–13 mm (5/12"–1/2") a vnitřní závit 5–12 mm (13/64"–1/2")

- Použití: Dořezávání pravých a levých závitů (metrické a nemetrické druhy závitů)
- Snadné a rychlé nastavení pomocí příslušného rýhovacího šroubu
- 1 pro hliníkový závit
- 1 prořezávač vnějších závitů
- 2 prořezávače vnitřních závitů
- Ochranné kryty pro hliníkové závity



HAZET No.		FAN-No. 4000896+	€
842 AIG-1/4	4	153428	197,10

842 N Sada pro opravu závitů

- Pro pancéřování závitů z materiálu s malou pevností ve stříhu, např. ve strojírenství, automobilové, elektro a medicínské technice
- Chromniklová Niro ocel zajišťuje dobrou kvalitu vnitřních závitů, které odolávají působení teplot a koroze
- Plastová skříňka

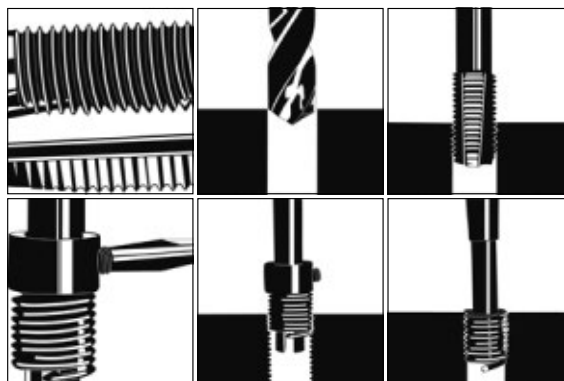

HAZET No.		FAN-No. 4000896+	€
-----------	--	------------------	---

- **118dílná sada**, M 6 až M 14
 - M 14 speciálně pro závity zapalovacích svíček
 - Obsah:
 - Po 25 závitových vložkách
M6 x 1,00 mm x 9,0 mm
M8 x 1,25 mm x 12,0 mm
M10 x 1,50 mm x 15,0 mm
 - 10 závitových vložek M 12 x 1,75 mm x 18,0 mm
 - Po 5 závitových vložkách
M 14 x 1,25 mm x 8,4 mm
M 14 x 1,25 mm x 12,4 mm
M 14 x 1,25 mm x 16,4 mm
 - 4 spirálové vrtáky, 5 závitníků, 5 montážních nástrojů, 4 odlamovače čepů
- | | | | |
|---------------|-----|--------|--------|
| 842 N-614/118 | 118 | 167272 | 341,60 |
|---------------|-----|--------|--------|



849 Sada závitníků

• HSS vysokovýkonný nástroj na řezání závitů

- Použití: Bezproblémové **dořezávání** závitů, i na obtížně přístupných místech
- Ovládání pomocí přepínací ráčny
- SmartCase (1/3) 165-L
- Safety-Insert-System, 2komponentní vložka z měkké pěny. Vložka vhodná také pro HAZET-Assistent
- Sada pro řezání závitů, obsah:
849 IG-M 3 · M 4 · M 5 · M 6 · M 8 · M 10 · M 12
849 AG-M 3 · M 4 · M 5 · M 6 · M 8 · M 10 · M 12
849 IG-6,3 · 8
849 AG-6,3 · 10
2100-025 · 2250-1 · 3



1/3				
-----	--	--	--	--

HAZET No.	d x š x v mm		EAN-No. 4000896+	€
849	355x235x65	21	035984	309,40

849 IG JEDNOTLIVÉ DÍLY

• Made in Germany

- Povrch: niklováno
- DIN ISO 2936

HAZET No.	l mm	l _i mm	l ₂ mm		EAN-No. 4000896+	€
• Závitník pro vnitřní závit						
849 IG-M 3	-	-	-	M3x0,5	036127	16,75
849 IG-M 4	-	-	-	M4x0,7	036134	16,75
849 IG-M 5	-	-	-	M5x0,8	036141	16,75
849 IG-M 6	-	-	-	M6x1,0	036158	16,75
849 IG-M 8	-	-	-	M8x1,25	036165	20,25
849 IG-M 10	-	-	-	M10x1,5	036103	23,05
849 IG-M 12	-	-	-	M12x1,75	036110	28,60
• Závitová čelist pro vnější závit						
849 AG-M 3	-	-	-	M3x0,5	036035	15,20
849 AG-M 4	-	-	-	M4x0,7	036042	15,20
849 AG-M 5	-	-	-	M5x0,8	036059	15,20
849 AG-M 6	-	-	-	M6x1,0	036066	15,20
849 AG-M 8	-	-	-	M8x1,25	036073	15,20
849 AG-M 10	-	-	-	M10x1,5	036011	15,20
849 AG-M 12	-	-	-	M12x1,75	036028	15,20
• Sklíčidlo						
• ● 6,3 = 1/4", pro závitníky 849 IG-M 3 až M 6 (ve spojení s adaptérem 2250-1)						
849 IG-6.3	-	-	-	-	036080	10,95
• Sklíčidlo						
• ● 8 = 5/16", pro závitníky 849 IG-M 8 až M 12 (ve spojení s adaptérem 2250-3)						
849 IG-8	-	-	-	-	036097	14,40
• Držák						
□ Pohon 6,3 = 1/4", pro závitnice 849 AG-M 3 až M 6						
849 AG-6.3	-	-	-	-	036004	31,55
• Držák						
□ Pohon 10 = 3/8", pro závitnice 849 AG-M 8 až M 12						
849 AG-10	-	-	-	-	035991	39,60
• Úhlový šroubovák						
2100-025	-	58,5	20,5	-	011285	2,20
• ○ 6,3 = 1/4" – □ 6,3 = 1/4"						
2250-1	23,5	-	-	-	015443	12,-
• ○ 8 = 5/16" – □ 10 = 3/8"						
2250-3	31	-	-	-	015474	16,20

2126 Závitový pilník

- Použití: Opravování poškozených vnějších a vnitřních závitů
- Povrch: niklováno
- Stoupání 0,8 až 3,0 mm



HAZET No.	l mm	EAN-No. 4000896+	€
2126	230	012497	57,55

847 Trhač matic, mechanický

• Made in Germany

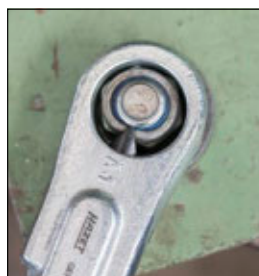

HAZET No.	Ø mm	EAN-No. 4000896+	€
• Trhání matic třídy jakosti 5 a 6			
847-0410 A	7–16	139903	78,60
847-1027 A	13–24	139910	115,-
• Náhradní sekáč pro mechanický trhač matic HAZET 847-0410 A a 1027 A			
847-10 A	-	144150	28,-



Měřicí technika

2154 N Měřicí pásma

- Přichytka na opasek
- Široká měřicí páska redukuje přehýbání
- Lze aretovat pomocí posuvného knoflíku s integrovanou ochranou proti sesmeknutí
- Volný hák (na konci měřicí pásky) pro vnitřní a vnější měření
- Dvoukomponentní pouzdro chráněné proti nárazům
- Kvalitní pružina zaručuje automatické zasunutí měřicí pásky
- Odolný povlak chrání před korozí a opotřebením
- Dvojitá měřicí stupnice (na horním a dolním okraji)

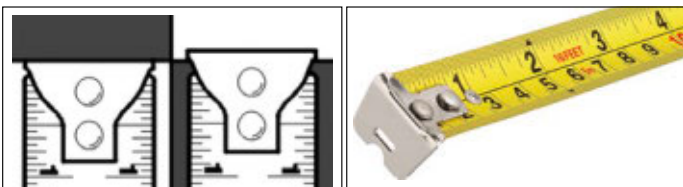

HAZET No.	l mm	b mm	EAN-No. 4000896+	€
2154 N-2	2000	16	143924	4,30
2154 N-3	3000	16	143931	6,15
2154 N-5	5000	19	143948	10,20

2154 N Měřicí pásma

Made in Germany

- Pro vnitřní a vnější měření
- EURO norma II
- 2 m
- Stabilní kryt z umělé hmoty ABS 76x56 mm



HAZET No.	l mm	EAN-No. 4000896+	€
2154-2	2000	013159	17,70



2154 Přesné posuvné měřidlo

Made in Germany

- Rozsah měření do 150 mm
- Tyč pro měření hloubky
- Dělení v mm a palcích
- Nonius 0,05 mm a 1/128"
- Zajišťovací šroub
- V pouzdru
- Z nerezavějící oceli
- DIN 862



HAZET No.	l mm	EAN-No. 4000896+	€
2154-10	234	013142	94,30

2154 Posuvné měřidlo · digitální

- Rozsah měření do 150 mm
- Tyč pro měření hloubky
- Přepnutí z mm na couly
- Datové rozhraní RS 232 C pro sběr dat
- Vypínač
- Včetně baterie
- Z nerezavějící oceli
- Plastová skříňka
- DIN 862



HAZET No.	l mm	EAN-No. 4000896+	€
2154 N-20	234	127696	97,65

2155 N Šroubový mikrometr

- Upínací kroužek a mikrometrický šroub
- Vřeteno zakryté, broušené a tvrzené, seřiditelné
- Izolační destičky
- Měřicí plocha s tvrdokovem
- Stoupání 0,5 mm
- Odečtení 0,01 mm
- Dřevěný box
- DIN 863-3



HAZET No.	EAN-No. 4000896+	€
2155 N-25	127702	66,60
2155-50	073276	167,70



2155 Úchylkoměr



2155-65



HAZET No.	EAN-No. 4000896+	€
-----------	------------------	---

Magnetický stojánek pro úchylkoměr

- Magnetický blok s prismatickou podložkou (např. pro hřídele)
- Magnetickou sílu lze přidávat samostatně
- Upnutí indikátoru pro rukojeť 4,5 mm a 8 mm
- Přidržené rameno s jemným nastavením a kloubem

2155-60	144303	46,-
---------	--------	------

Mechanický indikátor

- Členění stupnice: 0,01 mm
- Rozpětí měření: 8 mm
- 1 otáčka ukazatelem: 1 mm
- Otočná a aretovatelná stupnice
- Požadovaný rozsah lze vymezit pomocí dvou ukazatelů
- Upínací stopka Ø 8 mm
- Vhodný pro měřidlo HÚ 3688-10

2155-65	144501	49,30
---------	--------	-------

2145 Přesné vlasové pravítko

Made in Germany

• Kalená měřicí hrana

- Použití: Zkouška rovnosti (rovinnosti) ploch, např. hlava válce
- Broušeno a lapováno
- Nerezové
- Antireflexní materiál
- Ochrana rukou před teplem
- V pouzdře z umělé kůže
- DIN 874-2



HAZET No.	l mm	EAN-No. 4000896+	€
2145-500	500	073146	247,90

2147 Listová měrka

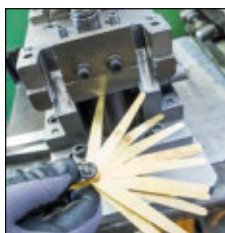

HAZET No.	l mm	mm	EAN-No. 4000896+	€
-----------	------	----	------------------	---

- Rozměry v mm = sada listových měrek D
- 20dílný stoupající o 0,05–1,0 mm
- Délka listů (otvor – špička): 69,73 mm
- Poloměr na špičce 15 mm
- Kontrola vzdálenosti elektrod zapalovacích svíček

2147	106	0,05–1,0	012824	20,50
------	-----	----------	--------	-------

- 2147 MS: z mosazi – **nemagnetické** –
- Nastavení např. snímačů na **na ABS**
- Kontrola vzdálenosti elektrod **na platinových zapalovacích svíčkách**
- 20-dílný stoupající o 0,05–1,0 mm
- Kontrola vzdálenosti elektrod zapalovacích svíček

2147 MS	106	0,05–1,0	057603	40,10
---------	-----	----------	--------	-------

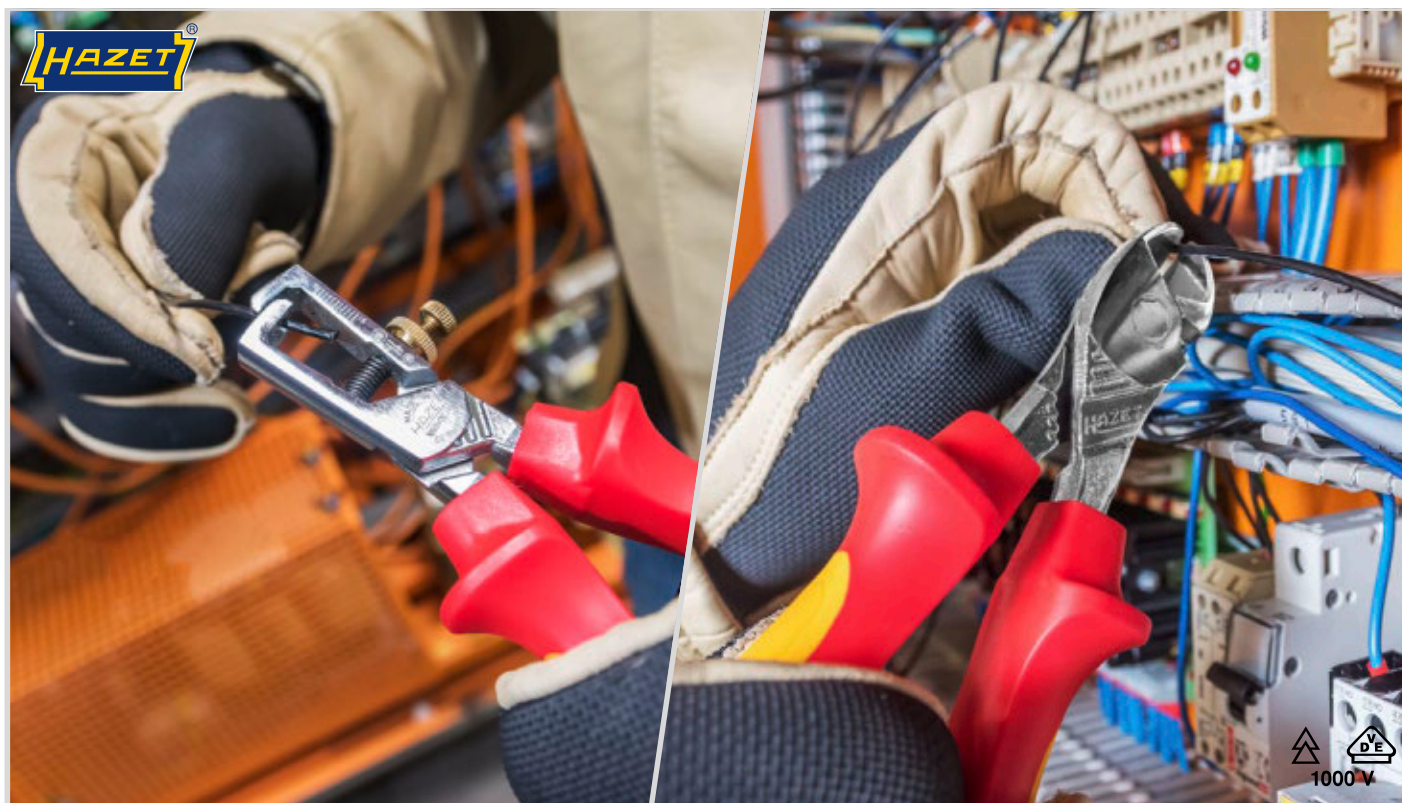



Nářadí s ochrannou izolací / elektrikářské nářadí



Sortiment, s ochrannou izolací

244

Šroubové klíče s ochrannou izolací

245

Nástrčné klíče s ochrannou izolací

245–247

Šroubováky s ochrannou izolací

247–249

Kleště s ochrannou izolací

249–250

Elektrikářské nářadí

250–251

Momentové klíče s ochrannou izolací

252





Nářadí s ochrannou izolací

Pro bezpečné použití do 1000 voltů

Co jsou 1000 V nástroje?

- Nástroje s ochrannou izolací mají speciální ochrannou izolaci a musí být přezkoušeny podle normy IEC 60900.
- Kromě toho norma vyžaduje označení jménem výrobce, označení modelu, typu a roku výroby. Nástroje s ochrannou izolací se poznají podle loga „dvojitého trojúhelníku“ a označení 1000 V hodnoty.
- Všechny požadavky podle normy DIN ISO, např. na utahovací moment, hodnoty síly a tvrdost, musejí být bezpodmínečně dosaženy a dodrženy.

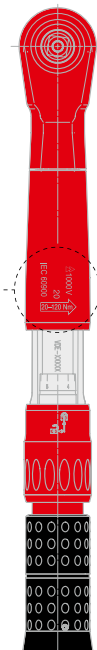
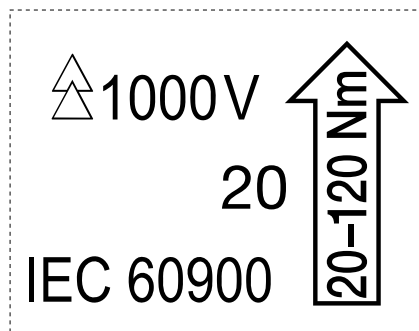

Speciální 1000 V ochranná izolace společnosti HAZET

- Nástroje s ochrannou izolací HAZET mají zpravidla dvoubarevnou vícevrstvou bezpečnostní izolaci, to znamená jednu vnější červenou a jednu vnitřní žlutou izolační vrstvu. Toto provedení podporuje předpis stavebního řádu BGV A3 (VBG-4)
- Izolace nesmí vykazovat žádné optické poškození. Pokud je někde vidět žlutá izolační vrstva, musí být nástroj neprodleně odstraněn – hrozí poranění elektrickým proudem. Práce pod napětím je v takovém případě vyloučená a životu nebezpečná.
- Nástroje s ochrannou izolací s technicky nastříkanou izolací mají pouze jednovrstvou červenou izolaci. Uživatel by proto měl z bezpečnostních důvodů před zahájením práce pod napětím zkontrolovat neporušenost izolace, a tak zajistit svou bezpečnost.

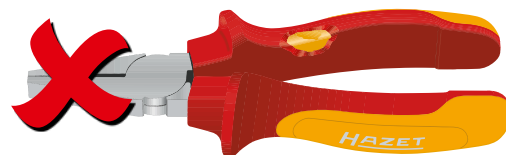
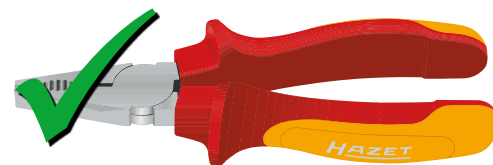

Co byste měli vědět o práci s 1000 V nástroji

Zde naleznete několik bezpečnostních pokynů pro vaši vlastní ochranu a bezpečnost:

- Veškeré práce pod elektrickým napětím smí provádět pouze vyškolený odborný personál
- Přípustné je výhradně nářadí a vybavení, které je opatřeno logem dvojitého trojúhelníku a piktogramem „1000 V“ (viz také konstrukční řád BGV A3)
- Před každou činností je nutné ověřit neporušenost izolace
- Poškozené nářadí zlikvidujte, resp. zajistěte, aby už NEBYLO používáno pro práce pod napětím
- Dodržování předpisů profesních sdružení atd., popř. dodavatelů elektrické energie
- 1000 V nástroje od společnosti HAZET zaručují spolehlivou a bezpečnou práci do 1000 V AC (střídavé napětí) a 1500 V (stejnoseměrné napětí)



Exemplární příklady zkoušek VDE

na modelu momentového klíče HAZET s ochrannou izolací

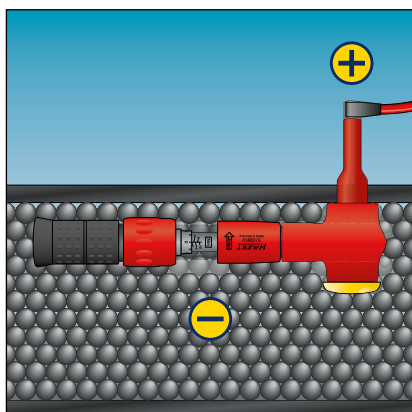

Elektrická zkouška [typová zkouška]:

Po 48 hodinách skladování ve vlhkém prostoru při tříminutovém měření pod 10 000 V nesmí nastat žádné průboje či průrazy v oblasti izolace.

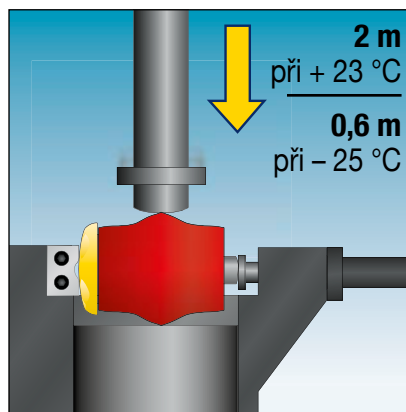

Zkouška odolnosti proti chladu [typová zkouška]:

S dobou setrvání 2 hodiny při teplotě okolního prostředí -25 °C nesmí mít izolace při cílených úderech a nárazech (pádová výška 0,6 m) žádné trhliny nebo jiná poškození.

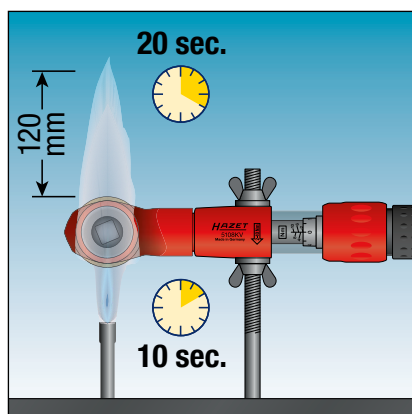

Zkouška hořlavosti [typová zkouška]:

Po 10 vteřinách v plameni nesmí být izolace vyhodnocena jako „snadno hořlavá“.

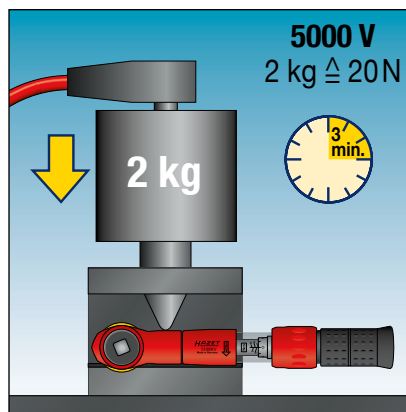

Tlaková zkouška [typová zkouška]:

Po 2hodinovém skladování při teplotě 70 °C nesmí při tlakovém zatížení 20 N a 3minutovém měření pod napětím 5 000 V docházet k žádným průrazům nebo probíjení u izolace.

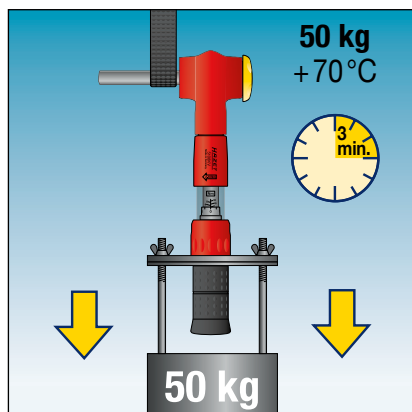

Zkouška adheze:

Po 168 hodinách skladování v klimatické skříni při teplotě $+70\text{ °C}$ se nesmí izolace při 3minutovém zatížení tahem s 500 N uvolnit nebo povolit.



0-20 Sada nářadí · s ochrannou izolací

- Sortiment nářadí pro elektrikáře
- IEC 60900:2018



- | | | |
|--|---------------|-------------|
| 810 VDE • ●
0.4x2.5 • 0.6x3.5 • 0.8x4 | 1816 VDE-22 | 1850 VDE-22 |
| 810 VDE-PH • ●
PH 1 • PH 2 | 1826 VDE-22 | 1862 |
| 839 • ●
0.5x2.8 | 1841 a VDE-22 | 2154 N-3 |
| 1803 VDE-33 | 1841 b VDE-33 | |

HAZET No.		FAN-No. 4000896+	€
0-20/14	14	192526	285,60



0-179 Sada nářadí

- Safety-Insert-System, 2komponentní vložka z měkké pěny. Vložka vhodná také pro HAZET-Assistent
- IEC 60900:2018
- Sada nářadí
- Ve vložkách z měkké pěny Safety Insert System

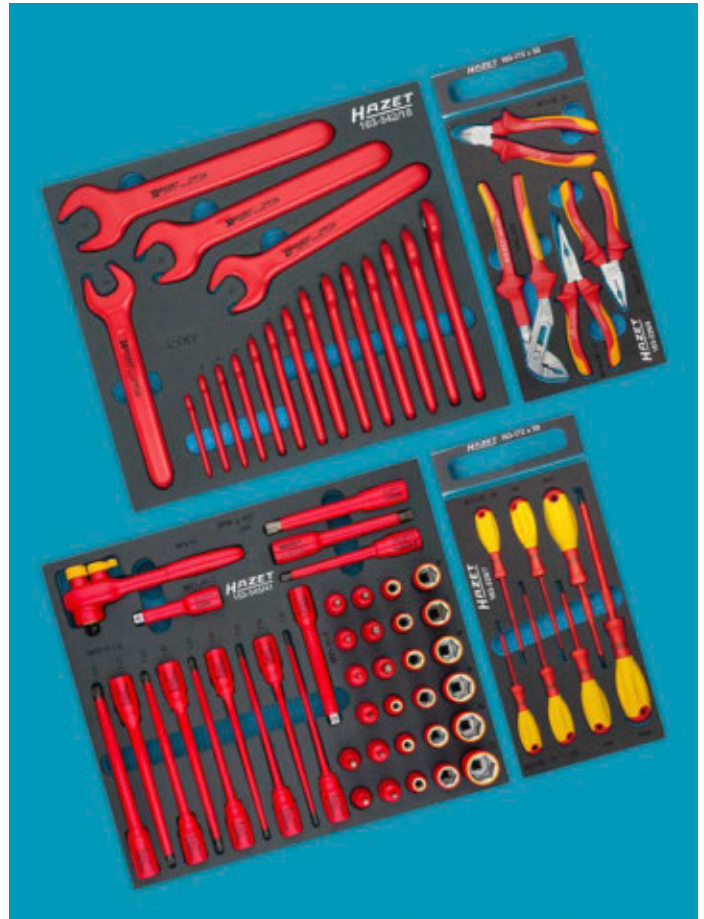

- | | | |
|---|--|---|
| 163-226/4 | 450 KV • ●
163-542/18 | 8801 K-KV • ● • $\frac{10}{32}$
5 • 6 |
| 759 N-2 VDE | 450 KV • ●
163-542/18 | 8802 KV • ● • $\frac{10}{32}$
T 10 • T 15 • T 20
T 25 • T 27 • T 30
T 40 • T 45 • T 50 |
| 1803 VDE-22 | 450 KV • ●
7 • 8 • 9 • 10 • 11
12 • 13 • 14 • 15 • 16
17 • 18 • 19 • 22 • 24
27 • 30 • 32 | 8802 KV-Lg • ● • $\frac{10}{32}$
T 10 • T 15 • T 20 • T 25
T 30 • T 40 • T 45 • T 50 |
| 1841 b VDE-33 | 8808 KV • ● • $\frac{10}{32}$
M 8 • M 10 • M 12 | 8816 KV • $\frac{10}{32}$ |
| 1850 VDE-22 | 880 KV • ● • $\frac{10}{32}$ • $\frac{10}{32}$ • $\frac{10}{32}$ • $\frac{10}{32}$
163-545/41 | 8821 KV • $\frac{10}{32}$ • $\frac{10}{32}$
8821 KV-3 • 8821 KV-5 |
| 810 VDE • ● • ●
163-229/7 | 880 KV • ● • $\frac{10}{32}$
6 • 7 • 8 • 9 • 10
11 • 12 • 13 • 14 • 16
17 • 18 • 19 • 20 • 22 | 163-172x50 |
| 810 VDE • ●
0.4x2.5 • 0.5x3
0.6x3.5 • 0.8x4 | | |
| 810 VDE-PH • ●
PH 1 • PH 2 • PH 3 | | |

HAZET No.		FAN-No. 4000896+	€
0-179/70 KV	70	235575	1700,-



Ruční nářadí

Nářadí s ochrannou izolací / elektrikářské nářadí



450 KV Ploché klíče · s ochrannou izolací

Made in Germany

- Úzká hlava
- Dřík s extra stabilním dvojitým T-profilem HAZET
- Poloha klíče: 15°
- Povrch: ochranná izolace
- IEC 60900:2018

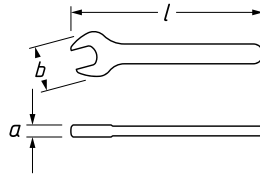

HAZET No.	l mm	a mm	b mm	EAN-No. 4000896+	€
450 KV- 7	88	6,2	19,3	231409	20,35
450 KV- 8	103	6,7	20,3	231416	20,50
450 KV- 9	108	6,7	22,9	231423	20,70
450 KV-10	113	7,2	25,1	231256	21,80
450 KV-11	123	7,6	27,3	231263	22,10
450 KV-12	133	7,7	29,2	231270	22,30
450 KV-13	143	8,5	31,1	231287	22,90
450 KV-14	153	8,7	32,9	231294	24,40
450 KV-15	166	10,4	35,8	231300	25,10
450 KV-16	171	10,4	37,9	231317	25,70
450 KV-17	171	10,9	39,8	231324	26,70
450 KV-18	181	11,4	41,8	231331	28,65
450 KV-19	186	11,4	43,8	231348	29,80
450 KV-22	211	11,9	50	231355	32,40
450 KV-24	238	13,3	54,3	231362	38,30
450 KV-27	258	13,6	60,2	231379	40,70
450 KV-30	278	14,6	66,7	231386	46,40
450 KV-32	298	14,6	70	231393	50,20

450 KV Sada plochých klíčů · s ochrannou izolací

Made in Germany

- Povrch: ochranná izolace
- IEC 60900:2018
- Hodí se pro HAZET *Assistent* s hloubkou zásuvky 398 mm: 173 · 179 · 179 N · 179 W · 179 N W · 179 BIG-1 · 179 XL · 179 N XL · 179 XXL · 179 N XXL · 179 A XXL · 179 T XXL · 180



2/3+			
------	--	--	--



450 KV · 7 · 8 · 9 · 10 · 11 · 12 · 13 · 14 · 15 · 16 · 17 · 18 · 19 · 22 · 24 · 27 · 30 · 32

HAZET No.	d x š mm	l mm	□	EAN-No. 4000896+	€
163-542/18	392x344	392	18	223626	562,-

630 KV Očkový klíč · s ochrannou izolací

Made in Germany

- Hluboče zalomeno
- Tenkostěnné hlavy
- Povrch: ochranná izolace
- IEC 60900:2018



630 KV Očkový klíč · s ochrannou izolací

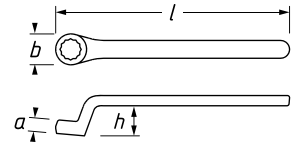

HAZET No.	l mm	h mm	a mm	b mm	EAN-No. 4000896+	€
630 KV- 7	152	15,5	6,4	13,6	231584	24,55
630 KV- 8	164	18	6,8	13,8	231591	24,95
630 KV- 9	164	18	7,3	15,5	231607	24,95
630 KV-10	172	20,5	7,6	17,5	231430	25,90
630 KV-11	178	20,5	8,7	19	231447	25,90
630 KV-12	193	22	8,7	20,5	231454	26,95
630 KV-13	198	22	9,3	22	231461	26,95
630 KV-14	209	23,5	10	23,5	231478	30,05
630 KV-15	214	24	11	24	231485	30,05
630 KV-16	217	26,5	11	27,5	231492	31,60
630 KV-17	223	26,5	11	27,5	231508	31,75
630 KV-18	234	28,5	11,5	30	231515	34,20
630 KV-19	234	28,5	11,5	31	231522	34,30
630 KV-22	263	30	13	35,5	231539	35,60
630 KV-24	280	31	13	38	231546	42,45
630 KV-27	295	32	14	42	231553	42,55
630 KV-30	305	33	16	46	231560	48,70
630 KV-32	312	34	16	48	231577	49,-

630 KV Sada očkových klíčů · s ochrannou izolací

Made in Germany

- Povrch: ochranná izolace
- IEC 60900:2018
- Hodí se pro HAZET *Assistent* s hloubkou zásuvky 398 mm: 173 · 179 · 179 N · 179 W · 179 N W · 179 BIG-1 · 179 XL · 179 N XL · 179 XXL · 179 N XXL · 179 A XXL · 179 T XXL · 180



2/3+			
------	--	--	--



630 KV · 7 · 8 · 9 · 10 · 11 · 12 · 13 · 14 · 15 · 16 · 17 · 18 · 19 · 22 · 24 · 27 · 30 · 32

HAZET No.	d x š mm	l mm	□	EAN-No. 4000896+	€
163-543/18	392x344	392	18	223831	585,-

880 VDE Sada nástrčných klíčů · s ochrannou izolací

- Povrch: ochranná izolace
- IEC 60900:2018



1/3			
-----	--	--	--



880 KV · 6 · 7 · 8 · 9 · 10 · 11 · 12 · 13 · 14 · 16 · 17 · 18 · 19 · 20 · 22



8816 KV · 10%



8821 KV · 10% · 10%
8821 KV-3 · 8821 KV-5

HAZET No.	d x š mm	l mm	□	EAN-No. 4000896+	€
163-580/18	342x172	342	18	235520	467,60



880 KV Sada nástrčných klíčů · s ochrannou izolací

- Povrch: ochranná izolace
- IEC 60900:2018



Hodí se pro HAZET *Assistent* s hloubkou zásuvky 398 mm:
173 · 179 · 179 N · 179 W · 179 N W · 179 BIG-1 · 179 XL · 179 N XL · 179 XXL · 179 N XXL · 179 A XXL · 179 T XXL · 180



2/3+		
------	--	--



880 KV · · 3/8
6 · 7 · 8 · 9 · 10
11 · 12 · 13 · 14 · 16
17 · 18 · 19 · 20 · 22



8802 KV · · 3/8
T 10 · T 15 · T 20
T 25 · T 27 · T 30
T 40 · T 45 · T 50



8808 LgKV · · 3/8
M 8 · M 10 · M 12



8816 KV · 3/8



8801 K-KV · · 3/8
5 · 6



8802 KV-Lg · · 3/8
T 10 · T 15 · T 20 · T 25
T 30 · T 40 · T 45 · T 50

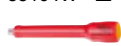

8821 KV · 3/8 · 3/8
8821 KV-3 · 8821 KV-5

HAZET No.	d x š mm		EAN-No. 4000896+	€
163-545/41	392x344	41	223855	954,-

880 KV Nástrčná hlavice · šestihran

Made in Germany

- Krátké provedení
- Povrch: ochranná izolace
- IEC 60900:2018

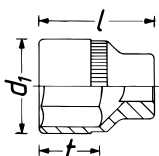
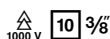

HAZET No.	l mm	d ₁ mm	d ₂ mm	f mm	EAN-No. 4000896+	€
880 KV- 6	40	14	23	6,5	231959	13,25
880 KV- 7	40	15	23	6,5	231966	13,25
880 KV- 8	40	16	23	6,5	231973	13,10
880 KV- 9	40	17,5	23	6,5	231980	13,25
880 KV-10	41	18,5	23	7,3	231843	13,60
880 KV-11	42	20	23	8,4	231850	13,60
880 KV-12	43	21	23	9,3	231867	13,55
880 KV-13	43,5	22,5	23	9,8	231874	13,75
880 KV-14	45,5	23,5	23	11,8	231881	14,-
880 KV-16	45,5	26	23	11,7	231898	14,20
880 KV-17	45,5	27,5	23	11,7	231904	14,55
880 KV-18	47,5	28,5	23	13,7	231911	14,85
880 KV-19	47,5	30	23	13,7	231928	15,05
880 KV-20	47,5	31	23	13,7	231935	15,25
880 KV-22	50	33,5	23	15,6	231942	15,50

8801 K-KV Nástrčná hlavice

Made in Germany

- Krátké provedení
- Povrch: ochranná izolace
- IEC 60900:2018

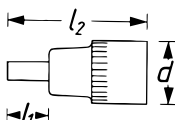
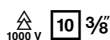

HAZET No.	l ₁ mm	l ₂ mm	d mm	EAN-No. 4000896+	€
8801 K-5 KV	12,5	60	23	231614	16,-
8801 K-6 KV	12,5	60	23	231621	16,-

8802 KV Nástrčná hlavice

Made in Germany

- Krátké provedení
- Povrch: ochranná izolace
- IEC 60900:2018

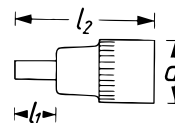
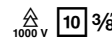

HAZET No.	l ₁ mm	l ₂ mm	d mm	EAN-No. 4000896+	€
8802 KV-T 10	12,5	59,5	23	231720	16,55
8802 KV-T 15	12,5	59,5	23	231737	16,85
8802 KV-T 20	12,5	59,5	23	231744	16,25
8802 KV-T 25	12,5	59,5	23	231751	16,25
8802 KV-T 27	12,5	59,5	23	231768	16,25
8802 KV-T 30	12,5	59,5	23	231775	16,95
8802 KV-T 40	12,5	59,5	23	231782	16,95
8802 KV-T 45	12,5	59,5	23	231799	17,05
8802 KV-T 50	12,5	60,5	23	231805	17,15

8802 KV-Lg Nástrčná hlavice

Made in Germany

- Dlouhé provedení
- Povrch: ochranná izolace
- IEC 60900:2018

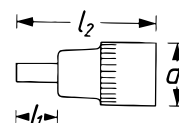
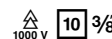

HAZET No.	l ₁ mm	l ₂ mm	d mm	EAN-No. 4000896+	€
8802 KV-Lg-T 10	153	187	23	231638	23,55
8802 KV-Lg-T 15	153	187	23	231645	23,85
8802 KV-Lg-T 20	153	187	23	231652	23,85
8802 KV-Lg-T 25	153	187	23	231669	23,80
8802 KV-Lg-T 27	153	187	23	231676	23,80
8802 KV-Lg-T 30	153	187	23	231683	23,80
8802 KV-Lg-T 40	153	187	23	231690	24,10
8802 KV-Lg-T 45	153	187	23	231706	24,10
8802 KV-Lg-T 50	153	187	23	231713	27,35

8808 LgKV Nástrčná hlavice

Made in Germany

- Dlouhé provedení
- Povrch: ochranná izolace
- IEC 60900:2018

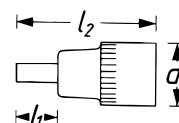
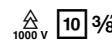

HAZET No.	l ₁ mm	l ₂ mm	d mm	EAN-No. 4000896+	€
8808 Lg- 8 KV	100	145,5	23	231836	23,30
8808 Lg-10 KV	100	144,5	23	231812	23,65
8808 Lg-12 KV	100	145,3	23	231829	19,80



Ruční nářadí

Nářadí s ochrannou izolací / elektrikářské nářadí



8821 KV Prodloužení 1000 voltů

Made in Germany

- S kuličkovou pojistkou
- Povrch: ochranná izolace
- IEC 60900:2018

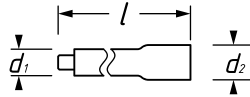
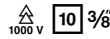

HAZET No.	l mm	d ₁ mm	d ₂ mm	EAN-No. 4000896+	€
8821 KV-3	90	17,5	23	231997	24,65
8821 KV-5	142	17,5	23	232000	24,95

900 KV Sada nástrčných klíčů · s ochrannou izolací

- Povrch: ochranná izolace
- IEC 60900:2018

Hodí se pro HAZET *Assistent* s hloubkou zásuvky 398 mm:
 173 · 179 · 179 N · 179 W · 179 N W ·
 179 BIG-1 · 179 XL · 179 N XL · 179 XXL ·
 179 N XXL · 179 A XXL · 179 T XXL · 180



2/3+			
------	--	--	--



900 KV · 10 · 11 · 12 · 13 · 14 · 15 · 16 · 17 · 18 · 19 · 20 · 22 · 23 · 24 · 26 · 27 · 30 · 32



986 LGKV · 4 · 5 · 6 · 8 · 10



917/918 KV · 917 KV-5 · 918 KV-10



916 KV

HAZET No.	d x š mm	■	EAN-No. 4000896+	€
163-544/26	392x344	26	223848	680,-

900 KV Nástrčná hlavice · šestihran · s ochrannou izolací

Made in Germany

- Povrch: ochranná izolace
- IEC 60900:2018

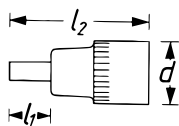
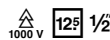

HAZET No.	l mm	d ₁ mm	d ₂ mm	t mm	EAN-No. 4000896+	€
900 KV-10	54	19,5	27	10,8	232017	14,25
900 KV-11	54	20,5	27	10,8	232024	14,20
900 KV-12	54	22	27	11,3	232031	14,30
900 KV-13	54	23	27	11,3	232048	14,25
900 KV-14	54	24,5	27	11,8	232055	14,35
900 KV-15	54	25,5	27	11,8	232062	14,35
900 KV-16	54	27	27	12,2	232079	14,55
900 KV-17	54	28	27	12,7	232086	14,55
900 KV-18	54	29,5	27	14,2	232093	15,45
900 KV-19	54	30,5	27	14,2	232109	15,50
900 KV-20	54	32	27	14,2	232116	15,20
900 KV-22	57,5	34,5	27	17,6	232123	16,-
900 KV-23	57,5	35,5	27	17,6	232130	16,65
900 KV-24	60	36,5	27	18,1	232147	17,05
900 KV-26	60	39	27	17,8	232154	17,35
900 KV-27	62	40	27	19,7	232161	18,20
900 KV-30	66	44	27	23,3	232178	21,50
900 KV-32	66	46,5	27	23	232185	22,40

986 LGKV Nástrčná hlavice šroubováku · s ochrannou izolací

Made in Germany

- Dlouhé provedení
- Povrch: ochranná izolace
- IEC 60900:2018

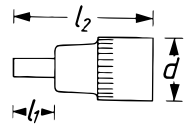
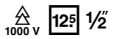

HAZET No.	l ₁ mm	l ₂ mm	d mm	EAN-No. 4000896+	€
986 Lg- 4 KV	102	156	27	232222	20,75
986 Lg- 5 KV	102	156	27	232239	20,85
986 Lg- 6 KV	102	156	27	232246	20,55
986 Lg- 8 KV	102	156	27	232253	19,15
986 Lg-10 KV	102	156	27	232215	19,90

917/918 KV Prodloužení · s ochrannou izolací

Made in Germany

- S kuličkovou pojistkou
- Povrch: ochranná izolace
- IEC 60900:2018

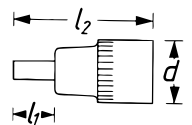
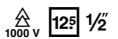

HAZET No.	l mm	EAN-No. 4000896+	€
917 KV- 5	140	232192	27,55
918 KV-10	264	232208	33,20

804 VDE Sada šroubováků · s ochrannou izolací

Made in Germany

- Bezpečnostní nářadí podle DIN ISO 60900



- Všechny šroubováky zkušeny při napětí 10 000 V, zaručující bezpečnou práci do 1 000 V
- Kulatá čepel
- Ergonomická 2komponentní rukojeť HAZET (červená/žlutá)
- Povrch: ochranná izolace
- IEC 60900:2018
- 2,5x0,4 · 3,0x0,5 · 3,5x0,6 · 4,0x0,8 · 5,5x1,0 · 6,5x1,2 mm
- PH 1 · PH 2
- PZ 2
- T 10 · T 15 · T 20



HAZET No.	■	EAN-No. 4000896+	€
804 VDE/14	14	133000	91,15



810 Sada šroubováků · s ochrannou izolací

- IEC 60900:2018
- Zkoušečka napětí, 220–250 V podle VDE 0680



810 VDE · ·
0.4x2.5 · 0.6x3.5 · 0.8x4

810 VDE-PH · ·
PH 1 · PH 2

839 ·
0.5x2.8



HAZET No.		EAN-No. 4000896+	€
810/6 VDE	6	179329	34,35

810 VDE Sada šroubováků · s ochrannou izolací

- Safety-Insert-System, 2komponentní vložka z měkké pěny.
- Vložka vhodná také pro HAZET-Assistent
- Povrch: ochranná izolace
- IEC 60900:2018



1/3			
-----	--	--	--



810 VDE · ·
0.4x2.5 · 0.5x3 · 0.6x3.5 · 0.8x4

810 VDE-PH · ·
PH 1 · PH 2 · PH 3

HAZET No.	$d \times \bar{s}$ mm		EAN-No. 4000896+	€
163-229/7	342x172	7	177844	56,55

810 VDE Sada šroubováků · s ochrannou izolací

- Povrch: ochranná izolace
- IEC 60900:2018



2/3			
-----	--	--	--



810 VDE · ·
0.4x2.5 · 0.5x3
0.6x3.5 · 0.8x4

810 VDE-PH · ·
PH 1 · PH 2 · PH 3

839 ·
0.5x2.8

810 VDE-T · ·
T 20 · T 25 · T 30

2156 VDE-2 ·

HAZET No.	$d \times \bar{s}$ mm		EAN-No. 4000896+	€
163-546/12	344x342	12	223619	101,60

810 VDE Elektrikářský šroubovák · s ochrannou izolací

- Kulatá čepel
- Ergonomická 2komponentní rukojeť HAZET (červená/žlutá)
- Povrch: špička mořená, ochranná izolace
- IEC 60900:2018

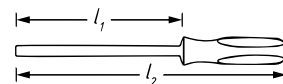
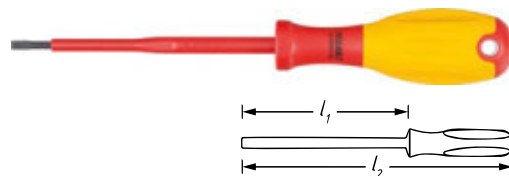

HAZET No.	l_1 mm	l_2 mm	$\frac{r}{mm}$	b mm	EAN-No. 4000896+	€
810 VDE-25	75	155	0,4	2,5	174089	5,05
810 VDE-30	100	180	0,5	3	174355	5,70
810 VDE-35	100	190	0,6	3,5	174362	6,15
810 VDE-40	100	190	0,8	4	174379	10,25

810 VDE-PH Elektrikářský šroubovák · s ochrannou izolací

- Kulatá čepel
- Ergonomická 2komponentní rukojeť HAZET (červená/žlutá)
- Povrch: špička mořená, ochranná izolace
- IEC 60900:2018

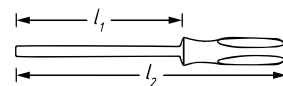
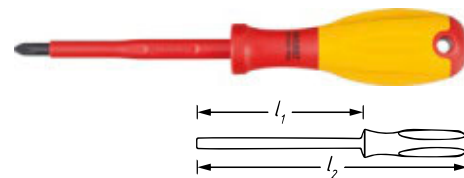

HAZET No.	l_1 mm	l_2 mm	EAN-No. 4000896+	€
810 VDE-PH 1	80	180	174386	6,85
810 VDE-PH 2	100	210	174393	7,35
810 VDE-PH 3	150	270	174409	10,65

810 VDE-T Elektrikářský šroubovák · s ochrannou izolací

- Kulatá čepel
- Ergonomická 2komponentní rukojeť HAZET (červená/žlutá)
- Povrch: špička mořená, ochranná izolace
- IEC 60900:2018

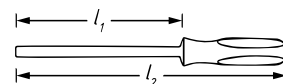
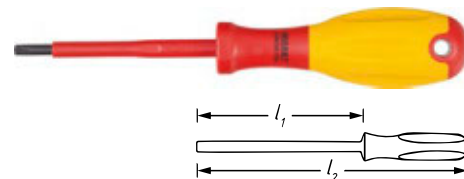

HAZET No.	l_1 mm	l_2 mm	r mm	EAN-No. 4000896+	€
810 VDE-T 20	80	180	3,86	174416	8,-
810 VDE-T 25	80	180	4,43	174423	8,95
810 VDE-T 30	100	210	5,52	174430	10,40





Ruční nářadí

Nářadí s ochrannou izolací / elektrikářské nářadí



839 Zkoušečka napětí

Made in Germany

- 220–250 V podle VDE 0680
- Břit s drážkou s dutým výbrusem
- Velmi dlouhá rukojeť, 92 mm
- Se závěsem
- Defektní žárovku Soffitte nelze podle VDE vyměnit
- Kulatá čepel
- Plastová rukojeť
- IEC 60900:2018

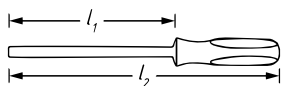

HAZET No.	l ₁ mm	l ₂ mm	φ mm	b mm	EAN-No. 4000896+	€
839-1	58	150	0,5	2,8	035670	4,05

163 Sada kleští · s ochrannou izolací

Made in Germany

- Safety-Insert-System, 2komponentní vložka z měkké pěny. Vložka vhodná také pro HAZET-Assistent
- Povrch: ochranná izolace
- IEC 60900:2018

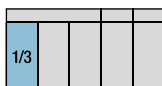

1802 VDE-22



1804 VDE-33



1860 VDE-11

HAZET No.	d x š mm	□	EAN-No. 4000896+	€
163-227/3	342x172	3	177868	161,40

Made in Germany

- Safety-Insert-System, 2komponentní vložka z měkké pěny. Vložka vhodná také pro HAZET-Assistent
- Povrch: ochranná izolace
- IEC 60900:2018



759 N-2 VDE



1803 VDE-22



1841 b VDE-33



1850 VDE-22

HAZET No.	d x š mm	□	EAN-No. 4000896+	€
163-226/4	342x172	4	177875	174,70

1850 VDE Kombinované kleště · s ochrannou izolací

Made in Germany

- Indukčně kalený břit s ostřím
- Tvrdost ostří: 60 HRC
- Ergonomické 2komponentní plastové kryty rukojetí HAZET (červená/žlutá)
- Povrch: leštěný chrom, ochranná izolace
- IEC 60900:2018, DIN ISO 5746



1850 VDE Kombinované kleště · s ochrannou izolací



HAZET No.	l mm	Rm N/mm ² ○ 800	Rm N/mm ² ● 1600	EAN-No. 4000896+	€
1850 VDE-22	160	2,5	1,8	007202	45,20
1850 VDE-33	180	2,8	2,5	007219	49,85
1850 VDE-44	200	3	2,8	007226	56,80

1803 VDE Stranové štípačky · s ochrannou izolací

Made in Germany

- Kloub bez vůle, s lehkým chodem
- Vložený kloub
- Indukčně kalený břit s ostřím
- Tvrdost ostří: 60 HRC
- Ergonomické 2komponentní plastové kryty rukojetí HAZET (červená/žlutá)
- Povrch: leštěný chrom, ochranná izolace
- IEC 60900:2018, DIN ISO 5749



HAZET No.	l mm	Rm N/mm ² ○ 800	Rm N/mm ² ● 1600	EAN-No. 4000896+	€
1803 VDE-22	160	2,8	2	006137	55,10
1803 VDE-33	180	3	2,5	006144	58,50

1802 VDE Silové stranové štípačky · s ochrannou izolací

Made in Germany

- Menší vynaložení síly díky umístění středu otáčení u čelistí



- Kované provedení
- Kloub bez vůle, s lehkým chodem
- Položený kloub
- Indukčně kalený břit s ostřím
- Tvrdost ostří: 64 HRC
- Ergonomické 2komponentní plastové kryty rukojetí HAZET (červená/žlutá)
- Povrch: leštěný chrom, ochranná izolace
- IEC 60900:2018, DIN ISO 5749



HAZET No.	l mm	Rm N/mm ² ○ 800	Rm N/mm ² ● 1600	Rm N/mm ² ● 2300	EAN-No. 4000896+	€
1802 VDE-22	180	3,8	2,7	2,2	086382	53,75

1804 VDE Kleště na kabely · s ochrannou izolací

Made in Germany

- Dvojitý břit
- Pro příčné stříhání měděných a hliníkových kabelů
- Rukojeť s povrchovou úpravou máčením
- Povrch: ochranná izolace
- IEC 60900:2018



HAZET No.	l mm	EAN-No. 4000896+	€
1804 VDE-33	208	173631	72,55



1841 AVDE Ploché kulaté kleště · s ochrannou izolací

Made in Germany

- Plochý kulatý tvar, indukčně kalené břity
- Přímé provedení
- Tvrdost ostří: 60 HRC
- Ergonomické 2komponentní plastové kryty rukojetí HAZET (červená/žlutá)
- Povrch: leštěný chrom, ochranná izolace
- IEC 60900:2018, DIN ISO 5745



HAZET No.	l mm	Rm N/mm ² O 800	Rm N/mm ² ● 1600	EAN-No. 4000896+	€
1841 a VDE-22	160	2,5	1,6	006397	52,85

1841 BVDE Ploché kulaté kleště · s ochrannou izolací

Made in Germany

- Plochý kulatý tvar, indukčně kalené břity
- Zahnuté provedení (45°)
- Tvrdost ostří: 60 HRC
- Ergonomické 2komponentní plastové kryty rukojetí HAZET (červená/žlutá)
- Povrch: leštěný chrom, ochranná izolace
- IEC 60900:2018, DIN ISO 5745



HAZET No.	l mm	Rm N/mm ² O 800	Rm N/mm ² ● 1600	EAN-No. 4000896+	€
1841 b VDE-33	200	2,8	1,8	006441	61,60

1816 VDE Ploché kleště · s ochrannou izolací

Made in Germany

- Dlouhé čelisti
- Plochý tvar
- Přímé provedení
- Ergonomické 2komponentní plastové kryty rukojetí HAZET (červená/žlutá)
- Povrch: leštěný chrom, ochranná izolace
- IEC 60900:2018, DIN ISO 5745



HAZET No.	l mm	EAN-No. 4000896+	€
1816 VDE-22	160	006298	47,50

1826 VDE Kulaté kleště · s ochrannou izolací

Made in Germany

- Dlouhé čelisti
- Kulatý tvar
- Ergonomické 2komponentní plastové kryty rukojetí HAZET (červená/žlutá)
- Povrch: leštěný chrom, ochranná izolace
- IEC 60900:2018, DIN ISO 5745



HAZET No.	l mm	EAN-No. 4000896+	€
1826 VDE-22	160	006328	47,05

759 N-VDE Univerzální kleště · s ochrannou izolací

Made in Germany

- Siko-kleště
- Průchozí kloub
- Hlava a kloub leskle broušené
- Ergonomické 2komponentní plastové kryty rukojetí HAZET (červená/žlutá)
- Povrch: ochranná izolace
- IEC 60900:2018, DIN ISO 8976



HAZET No.	l mm	sb mm	sb mm	EAN-No. 4000896+	€
759 N-2 VDE	251	30	10-36	174072	47,50

1860 VDE Odizolovací kleště · s ochrannou izolací

Made in Germany

- Pro dráty s průřezem vodiče do 6 mm²
- Se stavěcím šroubem a otevírací pružinou
- Ergonomické 2komponentní plastové kryty rukojetí HAZET (červená/žlutá)
- Povrch: leštěný chrom, ochranná izolace
- IEC 60900:2018



HAZET No.	l mm	EAN-No. 4000896+	€
1860 VDE-11	160	007288	52,95

1862 Automatické odizolovací kleště

Made in Germany

- Pro masivní a flexibilní kabely izolované PVC s průřezem vodiče 0,5 až 4 mm²
- Automatické nastavení na průřez vodiče, bezvadné odizolování
- Integrovaný boční řezač pro zkracování drátů
- Plastový kryt
- IEC 60900:2018



HAZET No.	l mm	EAN-No. 4000896+	€
1862	180	007301	37,90

1863 Automatické odizolovací kleště

• Automatické přizpůsobení tloušťce izolace, bezvadné odizolování

- Použití: Odizolování elektrických drátů, lankových vodičů a kabelů
- Pro měděná a hliníková vedení
- Oblast odizolování vodičů izolovaných PVC s průřezem 0,2 až 6 mm²
- Maximálně nastavitelná délka odizolování 18 mm
- Pružné uložené lamelové nože
- Řezač drátu od 4 mm² s jedním drátem do 6 mm² s jemným drátem
- IEC 60900:2018



HAZET No.	l mm	EAN-No. 4000896+	€
1863	205	007325	164,30



Ruční nářadí

Nářadí s ochrannou izolací / elektrikářské nářadí



4656 Konektorové kleště

Made in Germany

• Zpracování vodičového a izolačního krimpů v jedné pracovní operaci

- Intenzivní izolační krimp se speciální profilovou geometrií
- Integrovaný odblokovatelný zámek zajišťuje kompletní krimpování
- Mimořádně namáhané díly jsou speciálně zušlechťené
- Snadná manipulace
- Značení profilu
- Profily: / rozsahy průřezu:
 - červený: 0,5–1,0 mm² / AWG 20–16
 - modrý: 1,5–2,5 mm² / AWG 16–14
 - žlutý: 4,0–6,0 mm² / AWG 12–10
- Ergonomické měkké rukojeti s ochranou proti sesmeknutí
- Povrch: mořeno, olejováno



HAZET No.	l / mm	EAN-No. 4000896+	€
4656-1	220	127351	112,70

4658 Konektorové kleště

Made in Germany

• Rychlovýměnný systém (rychlá a snadná výměna hlavy kleští díky zástrčným čepům)

- Pro celou řadu neizolovaných kabelových a kontaktních spojů
- Integrované blokování zajišťuje úplný proces krimpování
- Nízká ruční síla díky optimálnímu převodovému poměru
- Rovnoměrné tvarování dutinek vodičů bez izolace a s izolací díky lineárnímu zalisování
- Polohování kontaktu nezávisle na zasunutém úseku v krimpovacím profilu pomocí izolačního stavěcího plechu
- Výměnná hlava pro rozsah průřezu 0,35 – 1,5 mm² kompletně včetně základního nástroje
- 1. profil: 0,35 – 0,5 mm²
- 2. profil: 1,5 mm²
- 3. profil: 0,5 – 1,0 mm²
- vodičový krimp = B-krimp / izolační krimp = O-krimp



HAZET No.	l / mm	EAN-No. 4000896+	€
4658-10	150	129515	242,60

2156 Nůž na kabely

- Nerezová čepel
- Plastová rukojeť



HAZET No.	l / mm	EAN-No. 4000896+	€
2156	110	013180	12,10

2156 VDE Kabelový a odizolovací nůž · s ochrannou izolací

Made in Germany

- S krytkou
- Čepel z nerezové oceli
- Plastová rukojeť
- IEC 60900:2018



HAZET No.	l / mm	EAN-No. 4000896+	€
2156 VDE-2	180	173549	18,55

196 VDE Izolační podložka

Made in Germany

• Pro práci na dílech pod vysokým napětím, v přenosné tašce



- Gumová podložka, prověřena: 50 000 V, podle VDE 0303
- Jedna strana hladká, jedna protiskluzová zoubkovaná
- Rozměry: 1000 x 1000 x 4,0 mm

Provedení přenosné tašky

- Odnímatelný popruh
- Délka: 1000 mm
- Průměr: 160 mm
- Polyester, červený
- IEC 60900:2018



HAZET No.	l / mm	EAN-No. 4000896+	€
196 VDE-8/2	2	174836	238,70

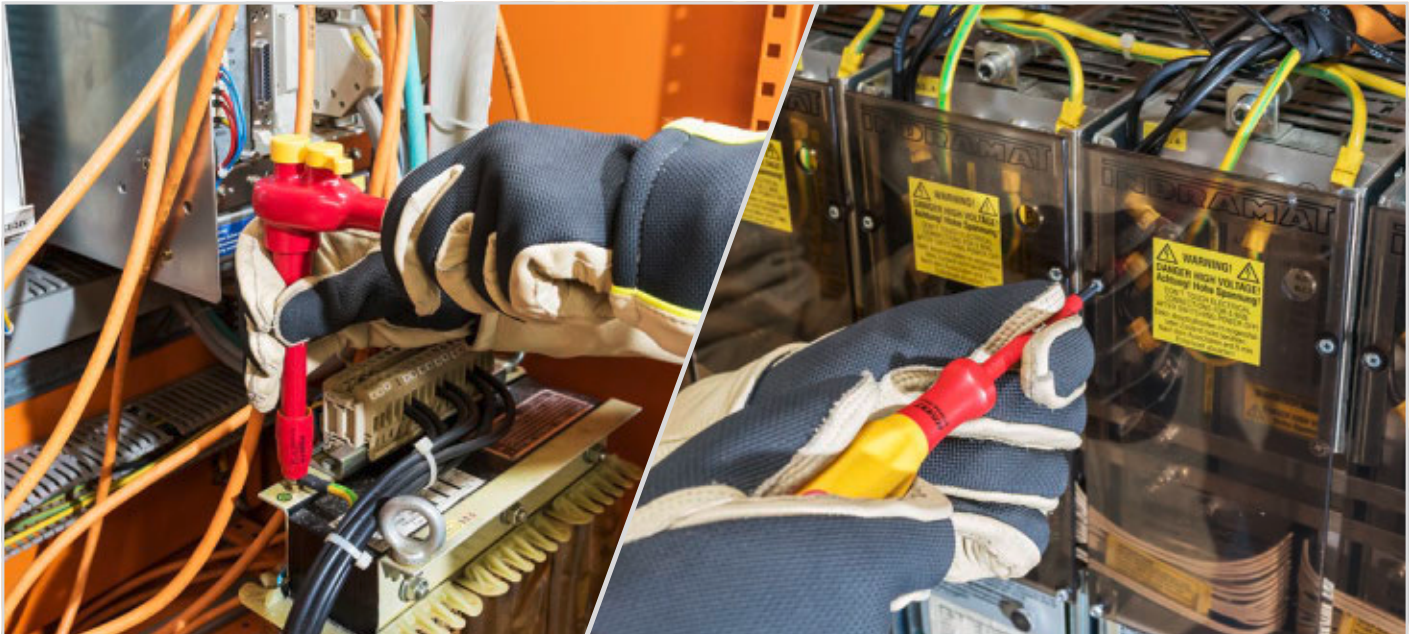



5000 KV Momentový klíč · s ochrannou izolací · SYSTEM 5000 KV (s prostrčným čtyřhranem) · ± 4% přesnost · 5108 KV 6% · 2–120 Nm

Made in Germany

• Lze znovu seřizovat a kalibrovat
Možnost oprav momentových klíčů KV v servisním středisku firmy HAZET

- Dlouhá životnost / přesnost díky možnosti provést:
 - Demontáž
 - Seřizování
 - Opravu (v případě potřeby)
 - Kalibrace
 - Montáž
- Vhodné pro kontrolu zkušebních prostředků
- Trvalé a ekologické
- Jemné dělení stupnice s noniem
- Zablokování proti nechtěné změně nastavené hodnoty
- Bezpečné:
 - Hapticky (krátký posun při vypnutí)
 - Akusticky (zalamovací prvek)
- Spouštění doprava /doleva díky přepínacímu čtyřhranu, díky tomu utahování s nastaveným utahovacím momentem oběma směry – vpravo i vlevo – v rámci uvedené tolerance
- Nízká hmotnost pro dobrou manipulaci a práci bez únavy

Designové prvky výrobu

- Štíhlý design s přísným dodržením potřebných izolačních faktorů (tloušťka materiálu / přesahy)
- Ohebné přechody na spínacích a pohyblivých dílech s ergonomickým tvarem rukojeti a zřetelnou kalibrační drážkou
- Jednotný vzhled i při použití dalších součástí (např. červené izolované nástrčné hlavice)
- Barevně sympatický vzhled pláště a hlavy v signálních barvách červené / žluté
- Černá barva rukojeti pro barevné odlišení a jako ochrana proti rychlému optickému znečištění
- Vyvarování se použití přesahujících, rušivých dílů (např. přepínací páky)
- DIN EN ISO 6789-2:2017, DIN 3120, ISO 1174-1, IEC 60900:2018



YouTube Clip

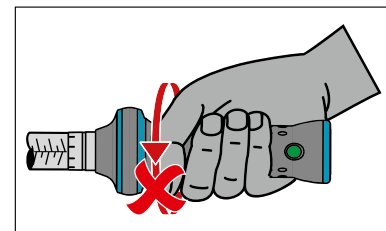

POZOR:

Opravy smí provádět pouze servisní středisko firmy HAZET, protože následně se musí provést kusová zkouška s 10 000 V podle IEC 60900

HAZET No.	Výstup	l mm	Přesnost vypnutí %	Nm	Nm	kg	EAN-No. 4000896+	€
5108 KV	■ 10 = 3/8"	275	6	2–10	0,2	1,0–5,0	235421	388,60
5109 KV	■ 10 = 3/8"	305	4	5–25	0,5	2,1–11,0	235445	399,80
5121 KV	■ 12,5 = 1/2"	420	4	20–120	1	6,0–37,4	233397	410,-



Ruční nářadí

Nářadí s ochrannou izolací / elektrikářské nářadí



SANTA TOOLS

HAZET
Das Werkzeug

Merry Christmas

Coming Soon
2021





Momentová technika



5000-3 CT	S přepínací ráčnou	± 3% / 4%	1–800 Nm		278
5200 CT	S nástrčným čtyřhranem	± 3%	10–200 Nm		279
5000 CLT	S displejem a přepínací ráčnou	± 4%	20–320 Nm		280
5000 KV	S ochrannou izolací, 1000 V přezkoušeno	± 4% / 6%	2 – 120 Nm		252
6000 CT	S přepínací ráčnou	± 2% / 4%	1–800 Nm		280
6000 CT	S možností demontáže, s přepínací ráčnou	± 3% / 4%	400–2000 Nm		282
6000 CT	Norma USA, s přepínací ráčnou	± 3%	5–600 lbf.ft		283
6200 CT	S nástrčným čtyřhranem	± 2% / 4%	2–500 Nm		284
6000 CT	Sady momentového nářadí				286
7000 sTAC	Elektronické, s nástrčným čtyřhranem a přepínací ráčnou	od ± 1% / ± 1 Digit ± 1°	1–1000 Nm		288
6000	Momentový šroubovák pro bity	± 6% / 10%	0,4–5,4 Nm		290
6000	Momentový šroubovák pro bity	± 5%	0,1–6 Nm		290
6300 CT	S nástrčným čtyřhranem a pevně nastavitelnou hodnotou	± 2% / 6%	1–320 Nm		291
	Nástrčné nářadí				293
	Kontrolní přístroje a příslušenství				296



Přehled momentových klíčů HAZET

	HAZET No.	Přesnost vypnutí		Rozsah měření
	5107-3 CT	± 4 %	6.3 1/4"	1–9 Nm
	5108-3 CT	± 3 %	6.3 1/4"	2.5–25 Nm
	5110-3 CT	± 3 %	10 3/8"	10–60 Nm
	5120-3 CT	± 3 %	12 ⁵ 1/2"	10–60 Nm
	5111-3 CT	± 3 %	10 3/8"	20–120 Nm
	5121-3 CT	± 3 %	12 ⁵ 1/2"	20–120 Nm
	5122-3 CT	± 3 %	12 ⁵ 1/2"	40–200 Nm
	5123-3 CT	± 3 %	12 ⁵ 1/2"	60–320 Nm
	5143-3 CT	± 3 %	12 ⁵ 1/2"	100–400 Nm
	5145-3CT	± 3 %	20 3/4"	300–800 Nm
	5290-3 CT	± 3 %	9 x 12	10–60 Nm
	5292-3 CT	± 3 %	14 x 18	40–200 Nm
	5121-2 CLT	± 4 %	12 ⁵ 1/2"	20–120 Nm
	5122-2 CLT	± 4 %	12 ⁵ 1/2"	40–200 Nm
	5123-2 CLT	± 4 %	12 ⁵ 1/2"	60–320 Nm
	5108 KV	± 6 %	10 3/8"	2–10 Nm
	5109 KV	± 4 %	10 3/8"	5–25 Nm
	5121 KV	± 4 %	12 ⁵ 1/2"	20–120 Nm
	6106-1 CT*	± 4 %	6.3 1/4"	1–6 Nm
	6108-1 CT*	± 2 %	6.3 1/4"	2–10 Nm
	6109-2 CT*	± 2 %	6.3 1/4"	4–40 Nm
	6110-1 CT*	± 2 %	10 3/8"	5–60 Nm
	6111-1 CT	± 2 %	10 3/8"	20–120 Nm
	6121-1 CT	± 2 %	12 ⁵ 1/2"	20–120 Nm
	6122-1 CT	± 2 %	12 ⁵ 1/2"	40–200 Nm
	6123-1 CT	± 2 %	12 ⁵ 1/2"	60–320 Nm
	6143-1 CT	± 2 %	20 3/4"	100–400 Nm
	6144-1 CT	± 2 %	20 3/4"	200–500 Nm
	6145-1 CT	± 2 %	20 3/4"	300–800 Nm
	6150-1 CT	± 3 %	20 3/4"	400–1000 Nm
	6160-1 CT	± 3 %	25 1"	600–1600 Nm
	6170-1 CT	± 4 %	25 1"	800–2000 Nm
	6114-1 CT*	± 3 %	10 3/8"	5–40 lbf.ft
	6115-1 CT	± 3 %	10 3/8"	20–100 lbf.ft
	6127-1 CT	± 3 %	12 ⁵ 1/2"	40–200 lbf.ft
	6128-1 CT	± 3 %	12 ⁵ 1/2"	50–250 lbf.ft
	6132-1 CT*	± 3 %	20 3/4"	120–600 lbf.ft

* = Bez signalizačního tlačítka



	HAZET No.	Přesnost vypnutí		Rozsah měření
	6280-1 CT	± 2 %	9 x 12	2–10 Nm
	6282-1 CT	± 2 %	9 x 12	4–40 Nm
	6281-2 CT	± 4 %	9 x 12	5–13 Nm
	6290-1 CT*	± 2 %	9 x 12	5–60 Nm
	6291-2 CT	± 2 %	9 x 12	20–120 Nm
	6291-1 CT	± 2 %	14 x 18	20–120 Nm
	6292-1 CT	± 2 %	14 x 18	40–200 Nm
	6293-1 CT	± 2 %	14 x 18	60–320 Nm
	6294-1 CT	± 2 %	14 x 18	100–400 Nm
	6295-1 CT	± 2 %	14 x 18	200–500 Nm
	6295-1 CT	± 2 %	14 x 18	200–500 Nm
	7280-2 sTAC	± 2 % / 1 digit	9 x 12 6.3 1/4"	1–10 Nm
	7281-2 sTAC	± 2 % / 1 digit	9 x 12 6.3 1/4"	2.5–25 Nm
	7290-2 sTAC	± 1 % / 1 digit	9 x 12 10 3/8"	5–60 Nm
	7291-2 sTAC	± 1 % / 1 digit	9 x 12 10 3/8"	10–100 Nm
	7292-2 sTAC	± 1 % / 1 digit	14 x 18 12.5 1/2"	20–200 Nm
	7294-2 sTAC	± 1 % / 1 digit	14 x 18 20 3/4"	40–400 Nm
	7295-2 sTAC	± 1 % / 1 digit	14 x 18 20 3/4"	65–650 Nm
	7250-2 sTAC	± 1 % / 1 digit	20 3/4"	200–1000 Nm
	7280-5 sTAC	± 2 % / 1 digit	9 x 12 6.3 1/4"	1–10 Nm
	7281-5 sTAC	± 2 % / 1 digit	9 x 12 6.3 1/4"	2.5–25 Nm
	7290-5 sTAC	± 1 % / 1 digit	9 x 12 10 3/8"	5–60 Nm
	7291-5 sTAC	± 1 % / 1 digit	9 x 12 10 3/8"	10–100 Nm
	7292-5 sTAC	± 1 % / 1 digit	14 x 18 12.5 1/2"	20–200 Nm
	7294-5 sTAC	± 1 % / 1 digit	14 x 18 20 3/4"	40–400 Nm
	7295-5 sTAC	± 1 % / 1 digit	14 x 18 20 3/4"	65–650 Nm
7250-5 sTAC	± 1 % / 1 digit	20 3/4"	200–1000 Nm	
	6001-1.4/3	± 10 %	6.3 1/4"	0.4–1.4 Nm
	6001-1.5/3	± 10 %	6.3 1/4"	0.6–1.5 Nm
	6001-3.0/3	± 6 %	6.3 1/4"	1.5–3 Nm
	6001-5.4/3	± 6 %	6.3 1/4"	3–5.4 Nm
	6002 CT	± 5 %	6.3 1/4"	10–120 cNm
	6003 CT	± 5 %	6.3 1/4"	100–600 cNm
	6391-10	± 6 %	9 x 12	1–10 Nm
	6391-12 (V)	± 2 %	9 x 12	2–12 Nm
	6391-25 (V)	± 2 %	9 x 12	2–25 Nm
	6391-35 (V)	± 2 %	9 x 12	15–35 Nm
	6391-50 (V)	± 2 %	9 x 12	5–50 Nm
	6391-85 (V)	± 2 %	9 x 12	15–85 Nm
	6392-200 (V)	± 2 %	14 x 18	50–200 Nm
	6392-320 (V)	± 2 %	14 x 18	60–320 Nm



Legenda k piktogramům

<i>b</i>	Šířka v mm
<i>a</i>	Výška v mm
<i>l</i>	Délka v mm
<i>s</i>	Velikost klíče v mm, resp. palcích
	TORX ® Velikost v mm
	Ovládací síla v kg
	Pro šrouby s vnitřním šestihranem
	Pro šrouby s vnějším šestihranem
	Pro vnitřní TORX ® šrouby

	Šestihranný TRAKČNÍ PROFIL
	Dvojitý šestihran TRAKČNÍ PROFIL
	Jmenovitý rozměr 6,3
	Jmenovitý rozměr 10
	Jmenovitý rozměr 12,5
	Jmenovitý rozměr 20
	Jmenovitý rozměr 25
	Vnitřní čtyřhran
	Vnější čtyřhran

	Vnitřní šestihran
	Vnější šestihran
	Zásuvné uchycení 9 x 12 mm u momentových klíčů
	Zásuvné uchycení 14 x 18 mm u momentových klíčů
	Počet zubů
	Úhel otočení
	Dělení stupnice

Servisní centrum HAZET

Přímý kontakt a pracoviště pro koordinaci služeb týkajících se našich produktů



☎ +49(0)2191/792-355
FAX +49(0)2191/792-523
e-mail service-center@hazet.de

- Nejlepší poprodejní servis s krátkými reakčními dobami a kompletní kompetencí společnosti HAZET získáte v našem speciálně zřízeném servisním centru.
- Servisní centrum HAZET nabízí následující základní služby:
 - Opravy, seřízení, kalibraci a certifikaci momentových klíčů HAZET
 - Provedení servisních činností u momentových klíčů, pneumatického nářadí, dílenských vozíků a ostatního katalogového programu HAZET
 - Krátké čekací doby
 - Kontaktní osoba pro servisní záležitosti

HAZET-WERK
 Service-Center
 Guldenerthor Bahnhofsstraße 25 - 29
 42857 Remscheid

Sehr geehrte Damen und Herren,
 anbei erhalten Sie folgende Werkzeuge zur Rückmeldung:
 Anzahl Artikel-Nr. Seriennummer(n) Rückgabetermin

Durch HAZET Service-Center
 auszuführen
 Eingangsdatum:

Meldungsnummer





HAZET – kompetence pro kalibraci utahovacího momentu a úhlu otáčení

Akreditace podle DIN EN ISO/IEC 17025 pro měřené veličiny:

- Utahovací moment (DIN EN ISO 6789-2:2017)
- Úhel otáčení (VDI/VDE 2648 list 2; bez bodu 4.2)

Splňuje speciální požadavky ISO/TS 16949 na kalibrační laboratoře (povinný předpoklad pro všechny subdodavatele v automobilovém průmyslu)

Vlastní kalibrační laboratoř společnosti HAZET zaručuje na základě akreditace optimální technickou kompetenci ke kalibrování

Opravňuje k vystavování kalibračních listů

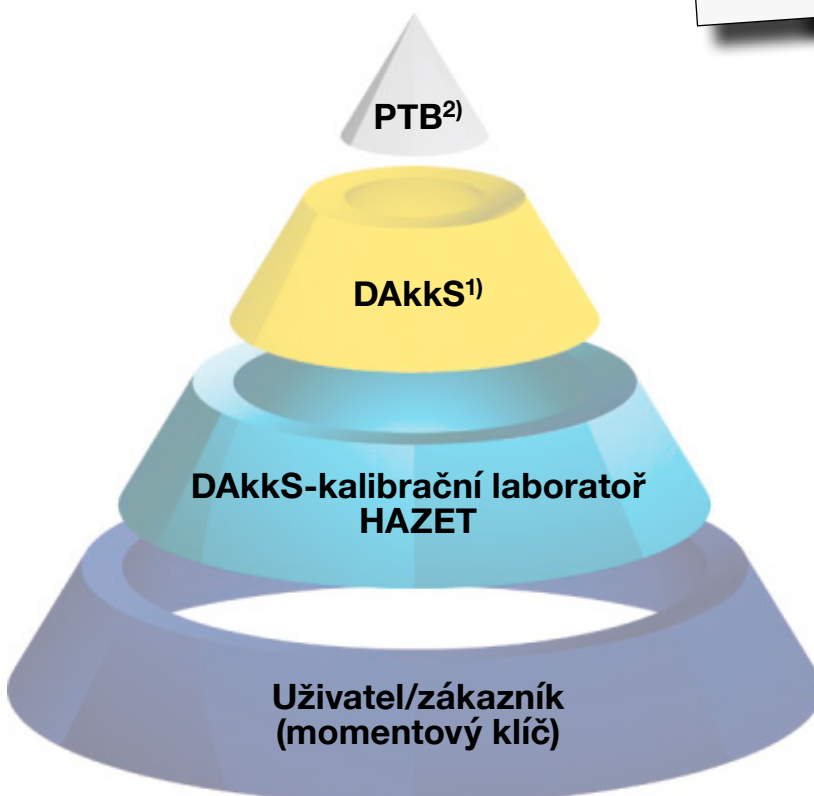
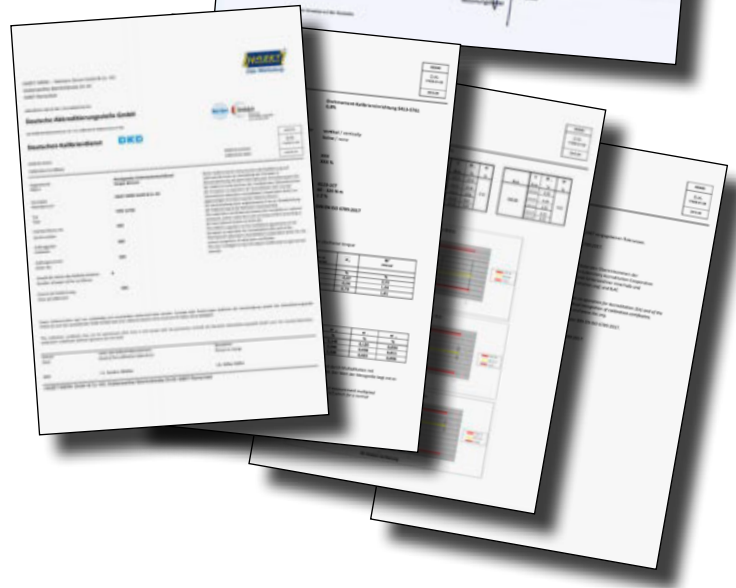

Deutsche Akkreditierungsstelle
D-K-17638-01-00

1) DAkks: Deutsche Akkreditierungsstelle GmbH (nár. německé akreditační pracoviště v Berlíně)

2) PTB: Physikalisch Technische Bundesanstalt (Fyzikálně technický spolkový ústav)



Kalibrační laboratoř DAkkS

Kompetence pro kalibraci utahovacího momentu a úhlu otáčení



Deutsche
Akkreditierungsstelle
D-K-17638-01-00

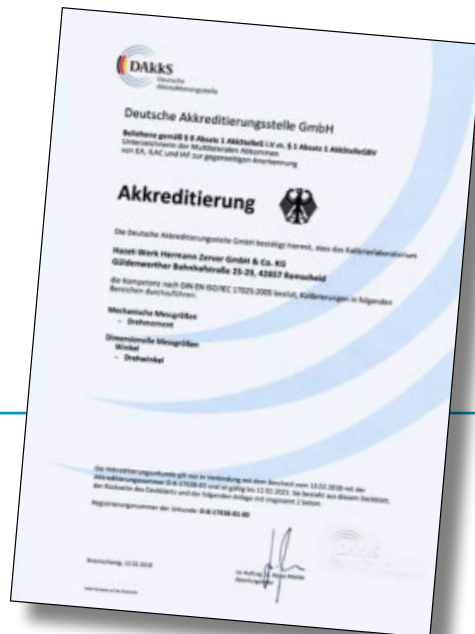

Věděli jste to?

- Akreditace podle DIN EN ISO/IEC 17025 pro měřené veličiny:
 - **Utahovací moment** (DIN EN ISO 6789-2:2017)
 - **Úhel otáčení** (VDI/VDE 2648 list 2; bez bodu 4.2)
- Splňuje speciální požadavky ISO/TS 16949 na kalibrační laboratoře (povinný předpoklad pro všechny subdodavatele v automobilovém průmyslu)
- Vlastní kalibrační laboratoř společnosti HAZET zaručuje na základě akreditace optimální technickou kompetenci ke kalibrování
- Oprávnění k vystavování kalibračních listů

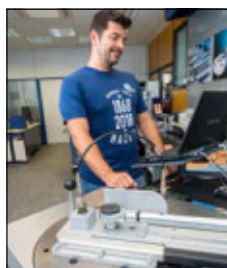

Klíč s kalibračním listem DAkkS

6106-1 CT CAL	6143-1 CT CAL	6290-1 CT CAL	7291-1 eTAC CAL	7280-2 sTAC CAL
6108-1 CT CAL	6144-1 CT CAL	6291-2 CT CAL	7292-1 eTAC CAL	7281-2 sTAC CAL
6109-2 CT CAL	6145-1 CT CAL	6291-1 CT CAL	7294-1 eTAC CAL	7290-2 sTAC CAL
6110-1 CT CAL	6150-1 CT CAL	6292-1 CT CAL	7291-2 eTAC CAL	7291-2 sTAC CAL
6111-1 CT CAL	6160-1 CT CAL	6293-1 CT CAL	7292-2 eTAC CAL	7292-2 sTAC CAL
6121-1 CT CAL	6280-1 CT CAL	6294-1 CT CAL	7294-2 eTAC CAL	7294-2 sTAC CAL
6122-1 CT CAL	6282-1 CT CAL	6295-1 CT CAL		7295-2 sTAC CAL
6123-1 CT CAL	6281-2 CT CAL			7250-2 sTAC CAL

- Možnost kalibrace DAkkS pro stávající klíče



... s maximální bezpečností pro profesionálního uživatele, zejména pro:

- letecký průmysl
- automobilový průmysl
- nové energie, větrné elektrárny, offshore parky
- petrochemický průmysl (ropa/plyn)

Dokumentace se zpětnou sledovatelností zaručuje souvislou doložitelnost!



Zvýšení kvality šroubení díky optimalizaci utahení šroubu

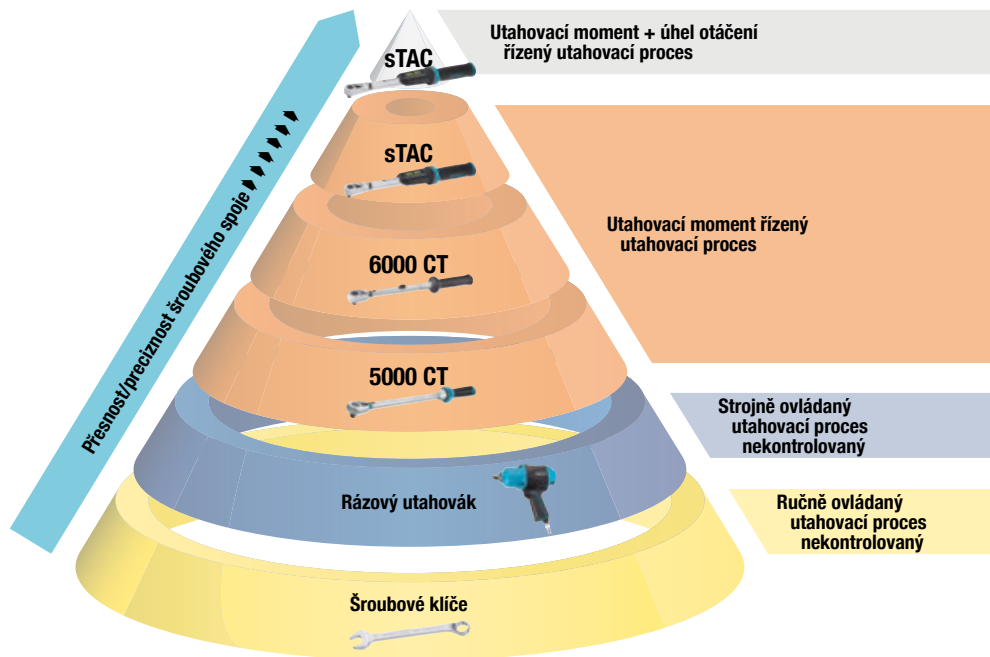

Jen pokud je zároveň v pořádku (O.K.) utahovací moment i úhel otáčení, je O.K. celý šroubový spoj (obr. ③)

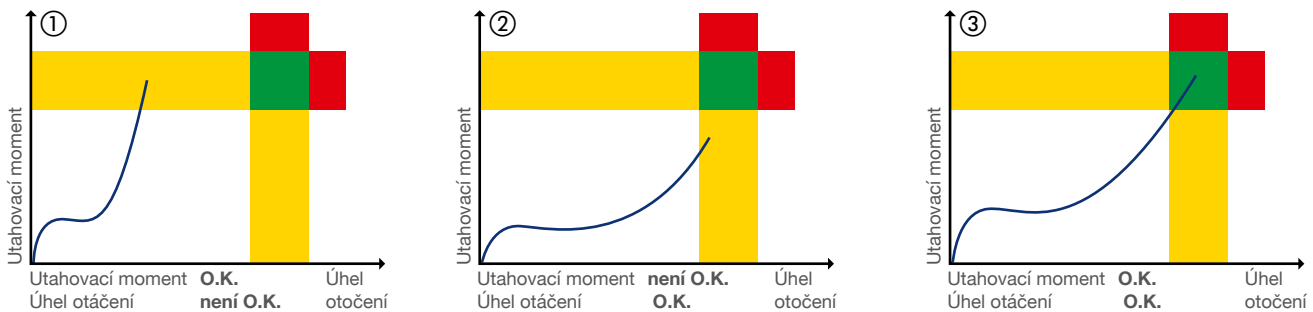

Důležité: Zejména u šroubení kategorie A (podle směrnice VDI 2862), např. pás, airbag nebo rotorové listy u větrných elektráren!

K obrázku 1:
Utahovací moment je dosažen, úhel otáčení není dosažen. – Možné příčiny:

- Použití nesprávného, příliš dlouhého šroubu.
- Součást, kterou je nutné přišroubovat, je příliš tenká a šroub nebo matice zůstávají ve výběhu závitu.
- Tření hlavy a/nebo závitu je příliš velké, např. proto, že povrch je příliš drsný a šroub se zřejmě „zadřel“. Povrchová úprava šroubu nesouhlasí, protože byl použit šroub s jinou povrchovou úpravou nebo je povrchová úprava vadná. Mazání je nedostatečné nebo bylo použito nesprávné mazivo.
- Šroub nebo závit jsou poškozené.
- Závit je chybně vyříznutý nebo nemá dostatečnou hloubku.
- Ve slepé díře závitu jsou třísky z řezání závitu.
- Nebyla instalována podložka nebo těsnění a šroub je tak v přímém kontaktu.

K obrázku 2:
Úhel otáčení je dosažen, utahovací moment není dosažen. – Možné příčiny:

- Použití nesprávného, příliš krátkého šroubu, závit je vytržený.
- Použití nesprávného šroubu s příliš nízkou pevností.
- Tření hlavy a/nebo závitu je příliš nízké, protože povrchová úprava šroubu nesouhlasí. Použití nesprávného šroubu.
- Použití nesprávného maziva.
- Šroub nebo závit jsou poškozené nebo je vytržený závit.
- Instalace nesprávného, příliš měkkého těsnění.



STAC

SYSTÉM 7000 sTAC

Elektronický momentový / úhlový klíč pro vysoce přesné šroubové aplikace s technologií Smart – Ready for Industry 4.0



Made in Germany

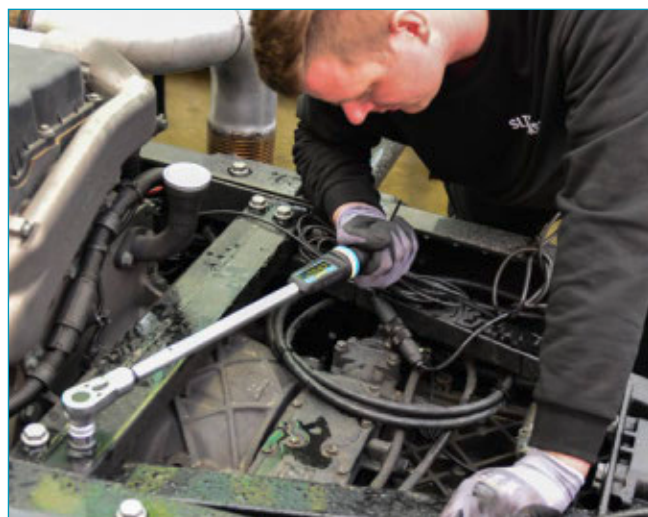



Utahovací moment

+ Úhel otočení

= 1 pracovní operace!

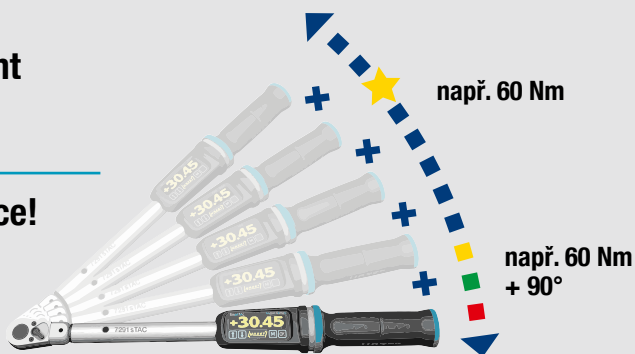

4násobná signalizace pro optimální kontrolu průběhu šroubování

Druh signálu

2 x opticky
pohyblivý číslicový ukazatel
+ 360° indikace LED



+ Akusticky

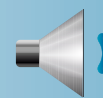
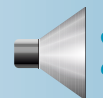
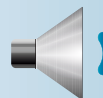

+ Vibrace

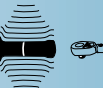
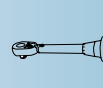
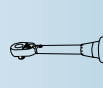

= 4násobně osvědčená bezpečnost šroubování podle principu HAZET!

- Prahová hodnota (stupeň varování předem)

✓ v pořádku

✗ není v pořádku

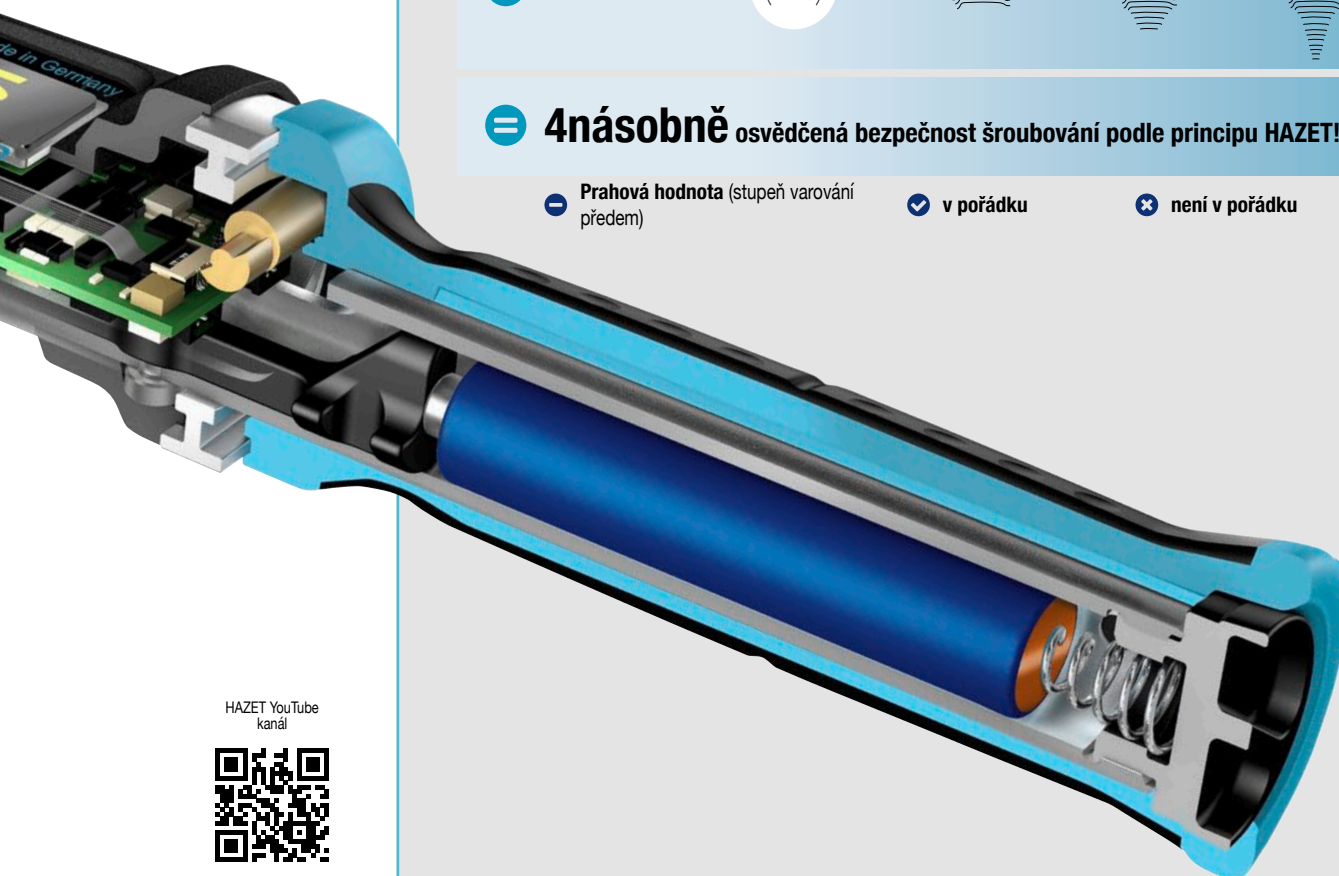

HAZET YouTube
kanál





SmartTAC SYSTEM 7000 sTAC

Elektronický momentový / úhlový klíč pro vysoce přesné šroubové aplikace s technologií Smart – Ready for Industry 4.0

HAZET technologie Smart skládající se z volitelné aplikace SmartTAC a Low Energy Bluetooth rozhraní (může podléhat národním omezením schválení) s bezproblémovou live výměnou dat pro zobrazení průběhu šroubování na mobilních koncových zařízeních jako smartphone (smartwatch) a tabletu či PC, jakož i přes rozhraní USB-C k programování momentového úhlového klíče a dokumentování dat šroubování přes notebook a PC.

Všechny momentové / úhlové klíče sTAC mohou být používány také samostatně, bez aplikace SmartTAC.

SmartTAC Aplikace k dostání pro:



DESKTOP PC



ANDROID



iOS

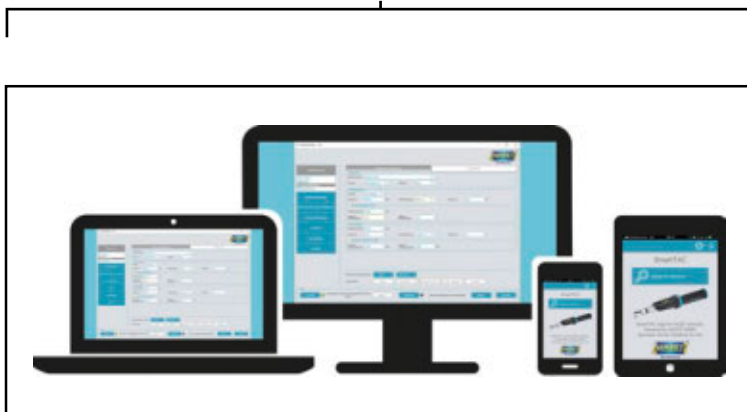



Skvělé vlastnosti

- Pro vysoce přesná šroubení s utahovacím momentem / úhlem otočení, při němž existuje vysoká přesnost nebo povinnost dokumentování, např. součásti motorů, zvláště šrouby hlav válců, stavba strojů se zvýšenými požadavky (mj. robotická technika atd.)
- **Jedinečný ergonomický, na uživatele orientovaný design HAZET veškerého nářadí pro profesionální použití**
- **Třída ochrany IP 40**, Displej a fóliová klávesnice chráněné proti stříkající vodě
- Vyzkoušený podle DIN EN ISO 6789-2:2017
- **USB-C rozhraní** k programování momentového / úhlového klíče a k dokumentování dat šroubování přes notebook a PC
- Včetně běžně prodejného, **výměnného akumulátoru Li-Ion**, typ 14650 / 3,7 voltu, který lze nabíjet přímo na nástroji přes konektor USB-C
- Včetně 1 metru USB 3.1 / A-C kabelu

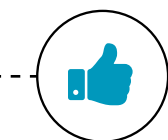
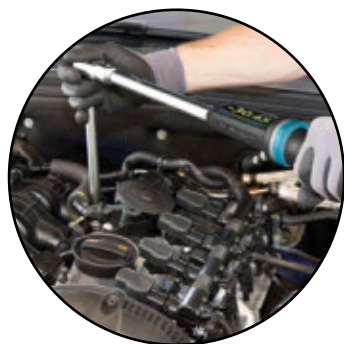

Ergonomický design
HAZET



IP 40
Chráněno proti
stříkající vodě



8 konstrukčních velikostí pro rozsahy utahovacích momentů 1 – 1.000 Nm

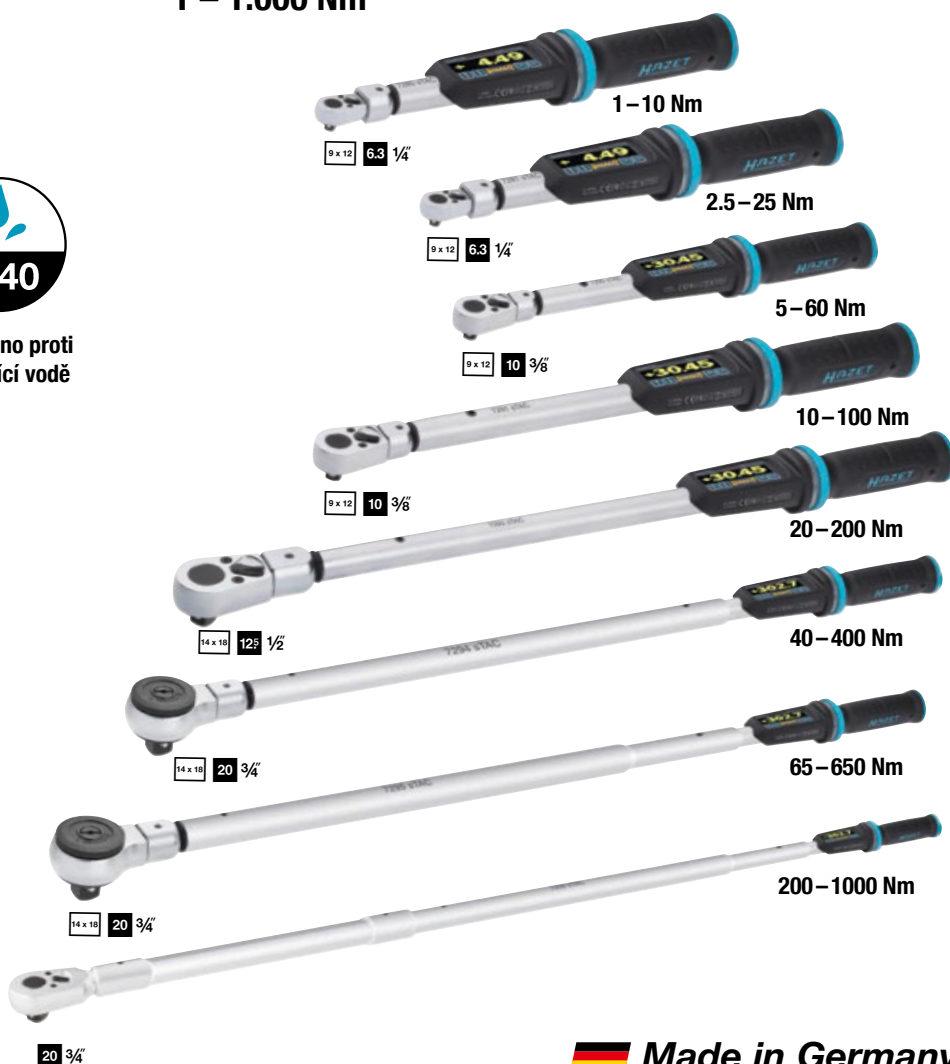

Made in Germany



Momentový klíč SYSTÉM 6000 CT

Vysoce precizní prvotřídní momentové nástroje – Pro nejvyšší nároky!

- **Rozsahy utahovacího momentu 1–2000 Nm**
- Přesnost $\pm 2\%$ z hodnoty stupnice (ve směru manipulace) podle normy DIN EN ISO 6789-2:2017 (3%: 6150-1 CT, 6160-1 CT / 4%: 6106-1 CT, 6170-1 CT)
Přesnost $\pm 3\%$ z hodnoty stupnice podle normy USA: 6114-1 CT až 6132-1 CT
- Přezkoušeno s osvědčením o kalibraci a sériovým číslem
- Otočné tlačítko pro dodatečné zajištění nastavení
- Čtyřhran podle DIN 3120 A, ISO 1174-1
- Individuálně se sériovým číslem
- Přepínací ráčny 6.3 1/4 10 3/8 12 1/2 20 3/4 25 T
- Ergonomický tvar
- Bezpečné:
 - Hapticky (krátký posun při vypnutí)
 - Akusticky (zalamovací prvek)
 - Opticky (podle modelu se signalizačním zařízením)



Také k dispozici s kalibračním listem DAkKS

... s maximální bezpečností pro profesionálního uživatele, zejména pro:

- letecký průmysl
- automobilový průmysl
- nové energie, větrné elektrárny, offshore parky
- petrochemický průmysl (ropa/plyn)

Dokumentace se zpětnou sledovatelností zaručuje souvislou doložitelnost!





Absolutní kvalita

Průřezový model momentového klíče HAZET 6000 CT

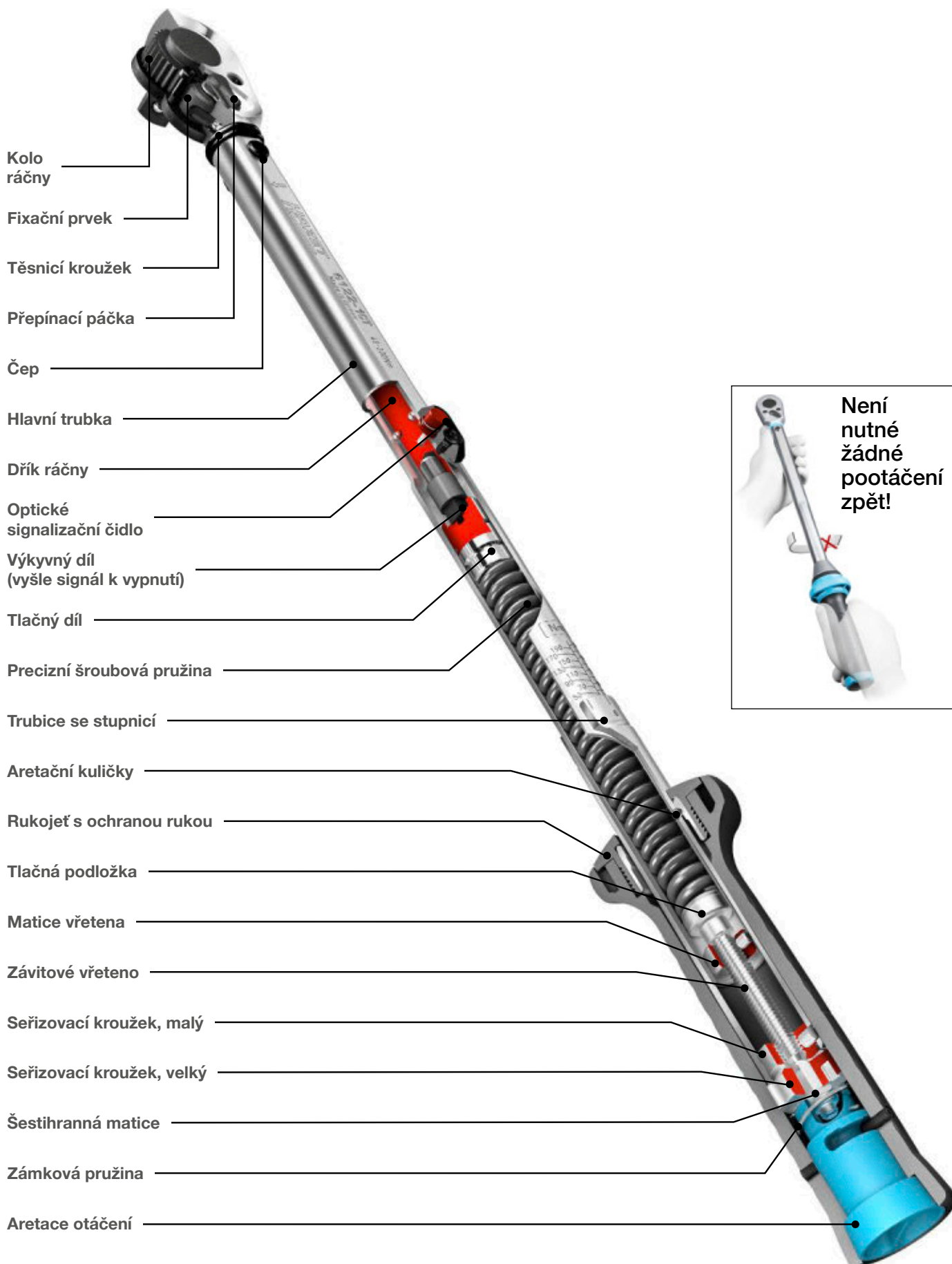



Momentový klíč SYSTÉM 5000-3 CT

Klasické nářadí naší dílny – dobré vybavení pro budoucnost.

Série 5000-3 CT ve třetí generaci

- Rozšířený rozsah měření série díky zvýšeným požadavkům trhu **1 – 800 Nm**
- Pohonný čtyřhran přepínacích ráčen (podle velikosti klíče): **6.3 1/4 10 3/8 12.5 1/2 20 3/4**
- **Přesnost ± 3 %** z hodnoty stupnice (ve směru utahování) (5107-3 CT ± 4 % přesnost spuštění)
- Koncipováno pro drsné dílenské nasazení
- Široké spektrum použití pro kontrolované utahování šroubů při servisu pneumatik, dvukolových aplikacích, u osobních automobilů, užitkových vozidel a rovněž při různých případech použití v průmyslu a řemesle.
- Optimalizovaný těsnicí kroužek na optimální ochranu před cizími tělesy
- Vyzkoušený podle DIN EN ISO 6789-2:2017
- Opravářská ráčnová sada pro zákaznicky orientovanou vlastní montáž umožní použití po desítky let
- Nastavovací pomůcka s aretačními body pro optimalizované vedení obsluhy zaručuje bezpečné a rychlé nastavení požadované hodnoty utahovacího momentu otočením rukojeti
- Možnost upevnění pro lankovou smyčku skrz otvory zajišťovacího otočného věnce
- Integrovaná přepínací páčka
- S osvědčením o kalibraci a sériovým číslem
- Dodávka ve stabilním otočném balení Hexa



HAZET YouTube
kanál



5000-3 CT
Představení
krátká verze

HAZET YouTube
kanál



5000-3 CT
Představení
dlouhá verze



**Není
nutné
žádné
pootáčení
zpět!**



Momentová technika



Pro správné „potočení“ ve správný „moment“ vždy ten správný nástroj!

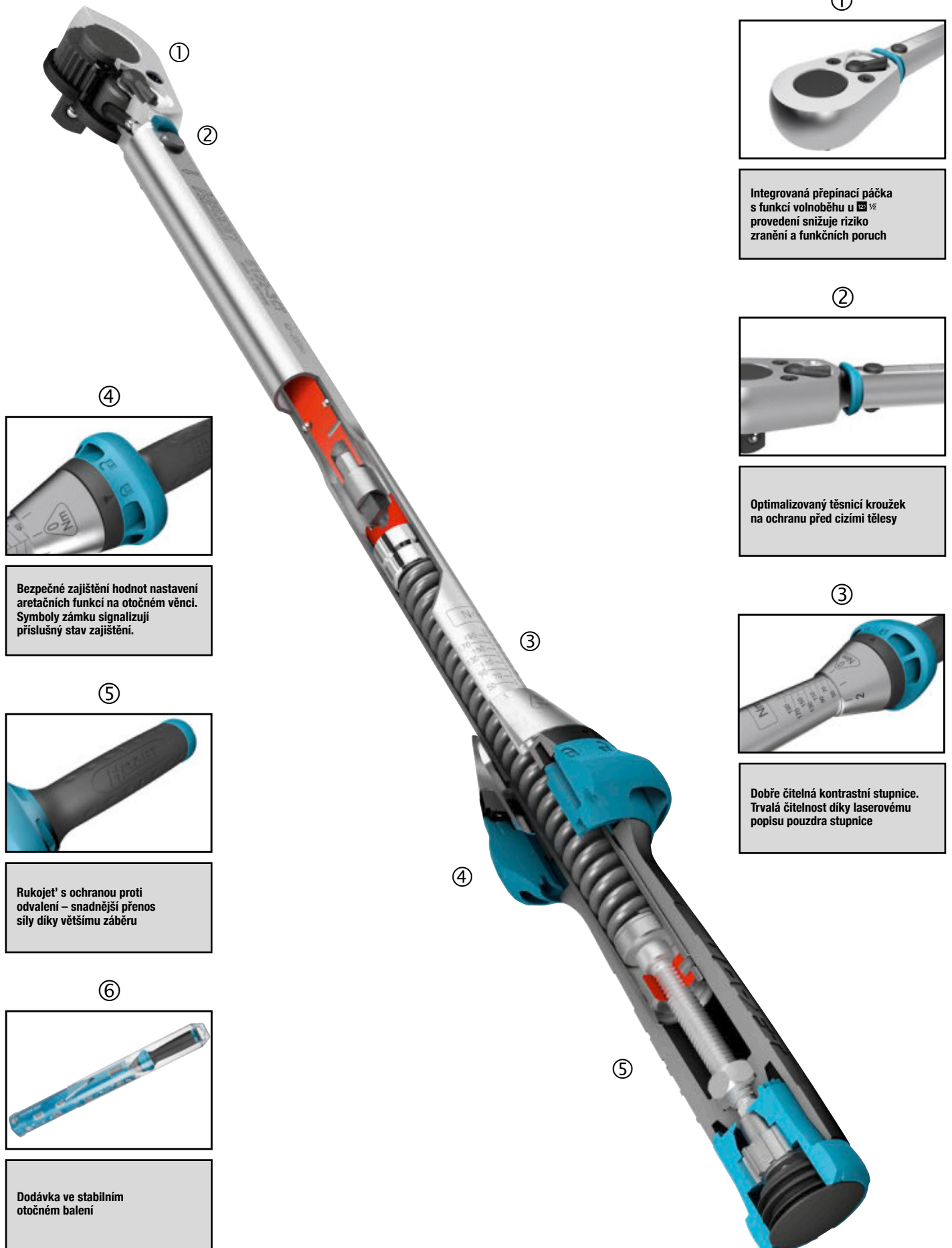

①



Integrovaná přepínací páčka s funkcí volnoběhu u 1/2 provedení snižuje riziko zranění a funkčních poruch

②



Optimalizovaný těsnicí kroužek na ochranu před cizími tělesy

③



Dobře čitelná kontrastní stupnice. Trvalá čitelnost díky laserovému popisu pouzdra stupnice

①

②

④



Bezpečné zajištění hodnot nastavení aretačních funkcí na otočném věnci. Symboly zámku signalizují příslušný stav zajištění.

⑤



Rukojeť s ochranou proti odvalení – snadnější přenos síly díky většímu záběru

⑥



Dodávka ve stabilním otočném balení



Nástrčné momentové klíče

Univerzální – S nejlepšími nastavci

Použitím více než 100 nástrčných nástrojů se zvládne každá výzva!

SYSTÉM 5200-3 CT

- Rozsahy utahovacího momentu 10–200 Nm
- **Přesnost $\pm 3\%$ z hodnoty stupnice**
- Vyzkoušený podle DIN EN ISO 6789-2:2017
- S osvědčením o kalibraci a sériovým číslem
- Rukojeť série 5000-3 CT
 - Aretační body pro rychlé nastavení hodnoty utahovacího momentu
 - Možnost upevnění pro lankovou smyčku
- Zástrčný čtyřhran 9×12 příp. 14×18 pro uchycení nástrčného náradí

SYSTÉM 6200-1 CT

- Rozsahy utahovacího momentu 2–500 Nm
- **Přesnost $\pm 2\%$ z hodnoty stupnice**
- Vyzkoušený podle DIN EN ISO 6789-2:2017
- S osvědčením o kalibraci a sériovým číslem
- Všechny výhody série 6000 CT
- Zástrčný čtyřhran 9×12 příp. 14×18 pro uchycení nástrčného náradí

SYSTÉM 6300

- S napevno nastavitelnou hodnotou – zvláště vhodné **pro použití v průmyslové sériové výrobě**
- Bez stupnice nastavení a signalizačního tlačítka
- **Přesnost opakování po 5.000 utažení $\pm 2\%$ (6391-10 $\pm 6\%$)**
- Automatické krátké vypnutí – dosažení nastavené hodnoty je signalizováno slyšitelně a citelně
- Funkce utahovacího momentu pouze pro pravotočivý závit
- Nastavení požadované hodnoty utahovacího momentu pomocí kombinovaného klíče 6399 ve spojení se zkušebním přístrojem – např. HAZET 7901 E, 7902 E nebo 7903 E
Neoprávněné přestavení je tím vyloučeno
- Rozsahy utahovacího momentu 1–320 Nm
- Vyzkoušeno podle DIN EN ISO 6789-2:2017
- S osvědčením o kalibraci a sériovým číslem
- Zástrčný čtyřhran 9×12 příp. 14×18 pro uchycení nástrčného náradí

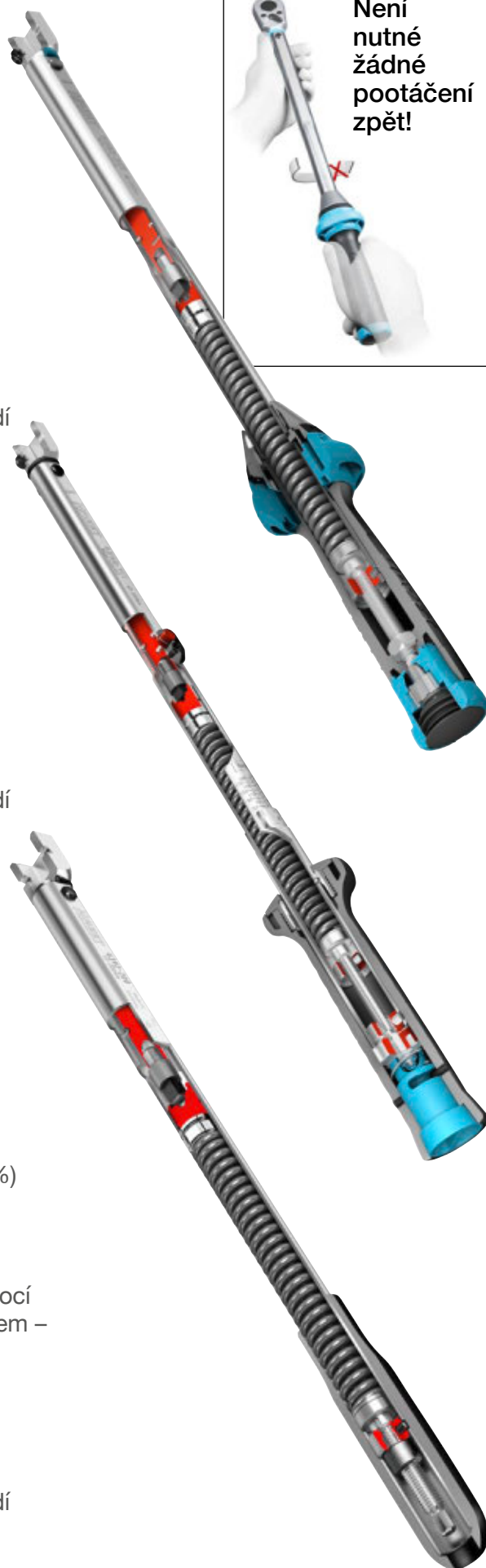



Nástrčné nářadí



Účinné délky u (jiných) nástrčných nástrojů

MDE = nastavený utahovací moment

MDV = předepsaný utahovací moment

l_j = standardní seřizovací délka se seřizovacím nářadím

l_1 = účinná délka momentového klíče

l_2 = odpich seřizovacího nářadí

l_w = odpich zásuvného nářadí

$$MDE = \frac{(l_1 + l_2) \times MDV}{l_1 + l_w}$$

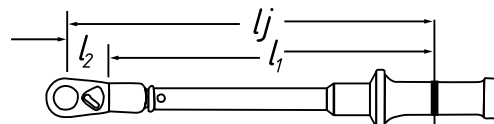

Vzorec: faktor korekce utahovacího momentu při změně účinné délky

Momentové klíče HAZET jsou seřizeny/kalibrovány s „ l_2 -nástrčnými rozměry“. Pokud chcete použít jiné nástrčné nástroje, je nezbytné zohlednit vzorec!

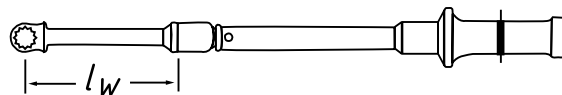

Rozměry různých momentových klíčů HAZET:

HAZET No.	l_1 mm	Seřízení pomocí HAZET č.	l_2 mm
6280-1 CT	140	6401-1 (S)	19,5
6281-2 CT	99	6401 N	17,5
6282-1 CT	200	6401-1 (S)	19,5
6290-1 CT	245	6402-1 (S)	30
6291-1 CT	330	6404-1 (S)	38,5

HAZET No.	l_1 mm	Seřízení pomocí HAZET č.	l_2 mm
6291-2 CT	312	6402-1 (S)	30
6292-1 CT	432	6404-1 (S)	38,5
6293-1 CT	547	6404-1 (S)	38,5
6294-1 CT	649.2	6406	44
6295-1 CT	893.2	6406	44

HAZET No.	l_1 mm	HAZET No.	l_1 mm
6391-10 (V)	102	6391- 50 (V)	201
6391-12 (V)	102	6391- 85 (V)	276
6391-25 (V)	143	6392-200 (V)	359
6391-35 (V)	143	6392-320 (V)	589



Běžné použití



Přepínací nástrčná ráčna 6602-1 · 6604-1



Nástrčný nástroj s očkem/ráčnou 6606 D

Momentové šroubováky

Jemnocitné - pro velmi malé hodnoty utahovacího momentu

- Použití s běžnými 6.3 1/4 bity (např. HAZET 2204 až 2225) a také použitím adaptéru 2304 s 6.3 1/4 nástrčnými hlavicemi
- Rozsahy utahovacího momentu 0,1–6 Nm
- Přesnost (z hodnoty stupnice) ± 5% (6002 CT a 6003 CT) příp. ±6–10% u série 6001





Momentový klíč SYSTÉM 5000 CLT, typ Click-Lens

„Dílenská klasika“ se snadným odečítáním hodnot

- Rozsahy utahovacího momentu 20–320 Nm
- Click-Lens-Type (CLT) s velkým zobrazením na displeji v průhledovém okně zajišťuje bezpečnost pro uživatele
- ± 4% Přesnost spuštění z hodnoty stupnice (ve směru manipulace) podle normy DIN EN ISO 6789-2:2017
- Vypnutí utahovacího momentu
 - citelně - krátkým posunem při vypnutí
 - akusticky – zvukem cvaknutí

Se sériovým číslem a osvědčením o kalibraci



12⁵ 1/2"

Robustní a odolná tvrdě chromovaná konstrukce z ocelových trubek ve štíhlém provedení



Click-Lens-Type (CLT)

- Bezpečné a přesné nastavení požadované hodnoty vypnutím. Optimální a zjednodušené odečítání hodnoty utahovacího momentu
- Velké třímístné číslice pro odečítatelné nastavení utahovacího momentu
- Velké vypouklé průhledové okénko (vyměnitelné) brání chybám při odečtu



– Uloženo v boxu s průhledovým oknem! –



Není nutné žádné pootáčení zpět!

1
Přepínací ráčna pro snadnou obsluhu
Jednoduchý servis (sady pro opravu ráčny pro vlastní montáž orientovanou na zákazníka)
Žádné nebezpečí ztráty čtyřhranu jako u prostrkovací ráčny

2
Integrovaná přepínací páčka s funkcí volnoběhu u 1/2" provedení snižuje riziko zranění a funkčních poruch

4
Ergonomicky tvarovaná rukojeť s nákrůžkem snižuje nebezpečí sesmeknutí nebo zranění
Nastavení požadované hodnoty utahovacího momentu rychle a bezpečně otočením rukojeti

5
Spolehlivá aretace na rukojeti

Oceněno



Made in Germany



Momentový klíč System 5000 KV

S ochrannou izolací – pro bezpečné použití do 1000 voltů

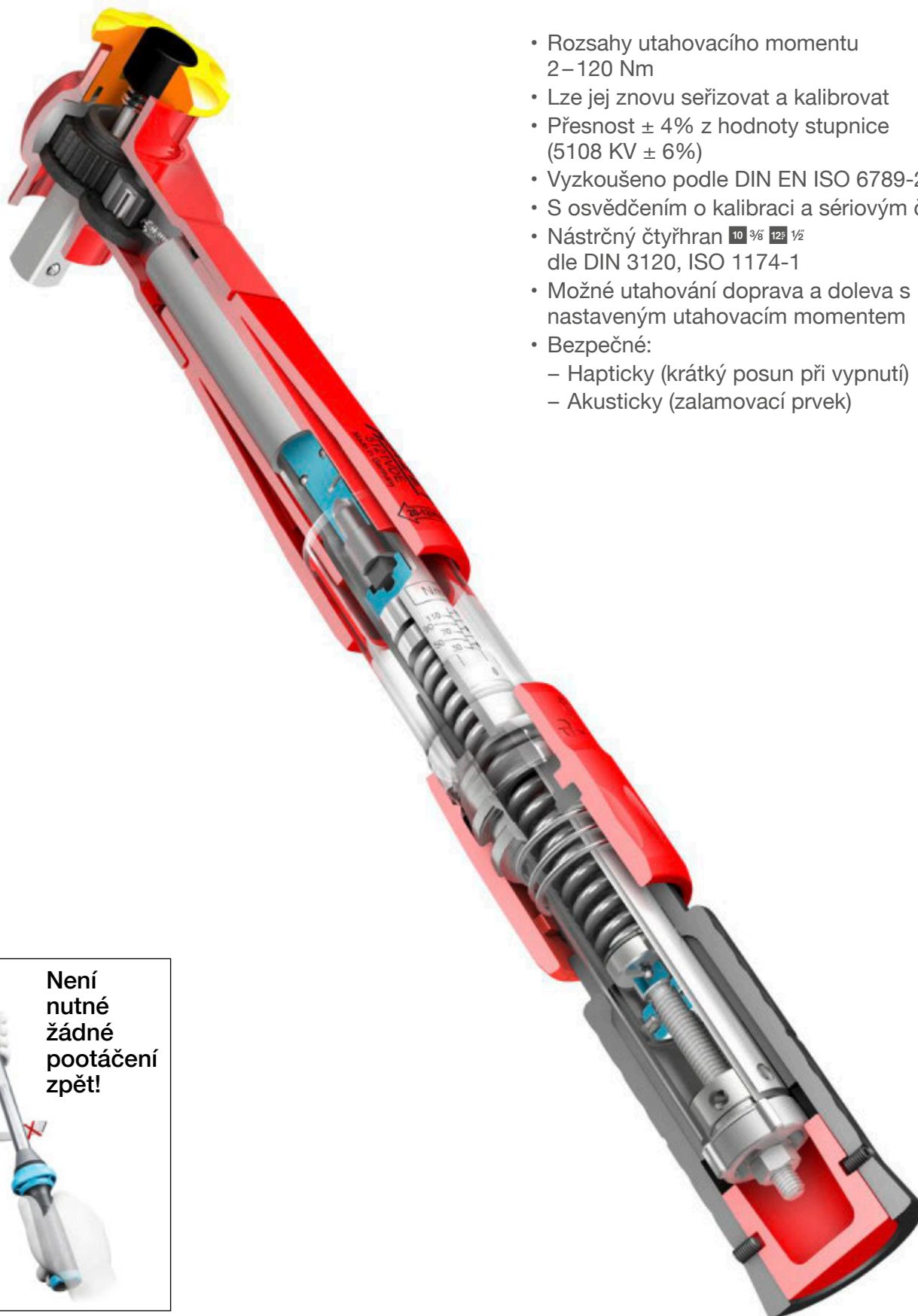

- Rozsahy utahovacího momentu 2–120 Nm
- Lze jej znovu seřizovat a kalibrovat
- Přesnost $\pm 4\%$ z hodnoty stupnice (5108 KV $\pm 6\%$)
- Vyzkoušeno podle DIN EN ISO 6789-2:2017
- S osvědčením o kalibraci a sériovým číslem
- Nástrčný čtyřhran 10 3/8 125 1/2 dle DIN 3120, ISO 1174-1
- Možné utahování doprava a doleva s nastaveným utahovacím momentem
- Bezpečné:
 - Hapticky (krátký posun při vypnutí)
 - Akusticky (zalamovací prvek)





Přepoččet

Převodní faktory pro hodnoty utahovacích momentů

Vzorec přepočtu:

Daná jednotka x faktor = požadovaná jednotka

Příklad:

Přepoččet z: 20 lbf.ft na Nm
 $20 \times 1,356 = 27,12 \text{ Nm}$

Daná jednotka	Požadovaná jednotka						
	mNm	cNm	Nm	kpm	ozf.in	lbf.in	lbf.ft
1 mNm	1	0.1	0.001	0.0001	0.142	0.009	0.0007
1 cNm	10	1	0.01	0.001	1.416	0.088	0.007
1 Nm	1000	100	1	0.102	141.6	8.851	0.738
1 kpm	9807	980.7	9.807	1	1389	86.8	7.233
1 ozf.in	7.062	0.706	0.007	0.0007	1	0.0625	0.005
1 lbf.in	113	11.3	0.113	0.0115	16	1	0.083
1 lbf.ft	1356	135.6	1.356	0.138	192	12	1

Konstrukce a funkce

- Při použití momentový klíč HAZET signalizuje dosažení nastaveného utahovacího momentu
 - slyšitelně cvaknutím,
 - citelně krátkým posunem při vypnutí
 - viditelně vyskočením červeného signalizačního tlačítka ① (podle modelu)
- Poté musí být pracovní operace okamžitě ukončena!
- Čím větší je nastavený utahovací moment, tím silnější jsou akustické a haptické signály.

Trubky kalené a tvrdě chromované

- Optimalizováno: hmotnost / tloušťka stěny
- Robustní a chráněný povrch

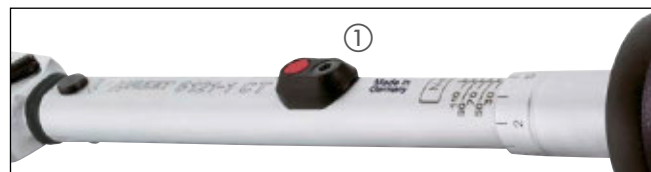

Příklady použití kódovacích kroužků:

- **Rychlá identifikace individuálně nastavených rozsahů Nm**
 např. zelená = vždy 250 Nm
- **Rozpoznání určitých oddílů / pracovních úseků nebo osob**
 např. červená = oddíl údržby/oprav
- **Rychlá identifikace různých momentových klíčů**
 např. žlutá = HAZET 6160-1CT (2dílný);
 červená = HAZET 6170-1CT (3dílný)
- **Jasně přiřazení stanovených pracovních procesů**
 např. červeně označené nástroje = pracovní proces 1,
 zeleně označené nástroje = pracovní proces 2

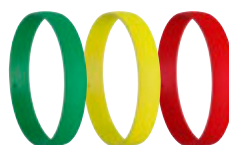

Včetně 3 dalších barevných kódovacích kroužků pro individuální odlišení nebo označení pracovních postupů



Princip funkce rukojeti momentového klíče

- Odblokovat
- Zmáčknout cca 8 mm dopředu a pootočit požadovaným směrem
- Po zacvaknutí rukojeti otáčejte dál, až dosáhnete požadovaného uťahovacího momentu (bez mačkání)
- Pootočte rukojeť kousek zpátky
- Zablokování



Aretace otáčení

● = Připraveno k nastavení / **NELZE** použít
(nastavení není dokončeno)



Otevřít = AUF



Aretace otáčení

● = Připraveno k práci / připraveno k použití



Zavřít = ZU



POZOR: aretace otáčení = ČERVENÁ – nepoužívat, hrozí nechtěné přestavení uťahovacího momentu!

Produktová skupina	Odblokování	Nastavení	Zablokování
5000 VDE	Zasunutí blokovacího pouzdra	Otáčení rukojetí, až je na stupnici dosaženo požadované hodnoty	Uvolnění blokovacího pouzdra
5000-3 CT	Otočný věnec otočit doprava	Otáčení rukojetí, až je na stupnici dosaženo požadované hodnoty	Otočný věnec otočit doleva
5000 CLT	Zablokování otočit doprava	Rukojeť posunout dopředu a otáčení rukojetí, až je v průzoru dosaženo požadované hodnoty	Zablokování otočit doleva
6106-1 CT – 6109-2 CT	Zasunutí blokovacího pouzdra	Otáčení rukojetí, až je na stupnici dosaženo požadované hodnoty	Uvolnění blokovacího pouzdra
6110-1CT – 6170-1 CT	Zablokování otočit doprava	Rukojeť posunout dopředu a otáčení rukojetí, až je na stupnici dosaženo požadované hodnoty	Zablokování otočit doleva
6280-1 CT – 6281-2 CT	Zasunutí blokovacího pouzdra	Otáčení rukojetí, až je na stupnici dosaženo požadované hodnoty	Uvolnění blokovacího pouzdra
6290-1 CT – 6295-1 CT	Zablokování otočit doprava	Rukojeť posunout dopředu a otáčení rukojetí, až je na stupnici dosaženo požadované hodnoty	Zablokování otočit doleva

Není nutné pootáčení zpět

U momentových klíčů HAZET konstrukční řady 5000 a 6000 bylo v rozsáhlých dlouhodobých testech prokázáno, že pootáčení zpět na nejmenší hodnotu dílku stupnice již není nutné pro praktické použití

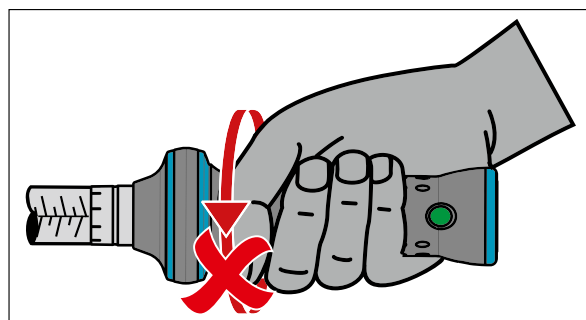



Utahovací momenty pro šrouby DIN 912 podle tříd pevnosti pro normální závit

Rozměry	Velikost klíče	Nástrčné nářadí			Předpínací síla (kN)						Utahovací moment (Nm)					
					Třída pevnosti						Třída pevnosti					
					4.6	5.6	6.8	8.8	10.9	12.9	4.6	5.6	6.8	8.8	10.9	12.9
M 2x0,40	4	-	-	-	0,338	0,422	0,675	0,901	1,267	1,52	0,13	0,163	0,261	0,348	0,489	0,587
M 3x0,50	5,5	-	-	-	0,845	1,056	1,689	2,253	3,168	3,801	0,48	0,6	0,961	1,281	1,801	2,161
M 4x0,70	7	9x12	-	-	1,463	1,829	2,927	3,902	5,487	6,585	1,115	1,393	2,229	2,972	4,18	5,016
M 5x0,80	8	9x12	-	-	2,395	2,994	4,79	6,387	8,982	10,778	2,261	2,827	4,523	6,03	8,48	10,176
M 6x1,00	10	9x12	-	-	3,379	4,224	6,758	9,011	12,671	15,205	3,843	4,803	7,685	10,247	14,41	17,292
M 8x1,25	13	9x12	14x18	-	6,202	7,753	12,404	16,539	23,258	27,909	9,349	11,686	18,698	24,931	35,059	42,07
M 10x1,50	17	9x12	14x18	-	9,876	12,345	19,752	26,336	37,034	44,441	18,54	23,18	37,09	49,45	69,54	83,44
M 12x1,75	19	9x12	14x18	-	14,4	18	28,801	38,401	54,001	64,801	32,37	40,46	64,74	86,32	121,38	145,66
M 14x2,00	22	-	14x18	-	19,775	24,719	39,551	52,734	74,158	88,989	51,77	64,71	103,54	138,06	194,14	232,97
M 16x2,00	24	-	14x18	-	27,221	34,027	54,443	72,591	102,08	122,497	80,62	100,77	161,24	214,98	302,32	362,78
M 18x2,50	27	-	14x18	-	33,078	41,347	66,155	88,207	124,041	148,85	111,09	138,86	222,17	296,23	416,58	499,89
M 20x2,50	30	-	14x18	-	42,534	53,167	85,067	113,423	159,501	191,401	157,46	196,82	314,91	419,88	590,46	708,55
M 22x2,50	32	-	14x18	21/26	53,175	66,469	106,35	141,8	199,406	239,288	215,1	268,9	430,2	573,7	806,7	968
M 24x3,00	36	-	14x18	21/26	61,248	76,56	122,497	163,329	229,681	275,617	272,1	340,1	544,2	725,6	1020,3	1224,4
M 27x3,00	41	-	14x18	21/26	80,67	100,837	161,339	215,119	302,512	363,014	399,9	499,9	799,9	1066,5	1499,7	1799,7
M 30x3,50	46	-	-	21/26	98,027	122,533	196,054	261,405	367,6	441,12	541,7	677,2	1083,4	1444,6	2031,5	2437,7
M 33x3,50	50	-	-	-	122,241	152,801	244,482	325,976	458,404	550,084	738,5	923,2	1477,1	1969,4	2769,5	3323,4
M 36x4,00	55	-	-	-	143,413	179,266	286,826	382,434	537,798	645,358	948	1185	1896	2528	3555	4265,9
M 39x4,00	60	-	-	-	172,42	215,525	344,839	459,786	646,574	775,888	1229	1536	2457	3276	4607	5529
M 42x4,50	65	-	-	-	197,407	246,758	394,813	526,417	740,275	888,329	1519	1899	3038	4050	5696	6835
M 45x4,50	70	-	-	-	231,206	289,007	462,412	616,549	867,022	1040,426	1898	2373	3796	5062	7118	8541
M 48x5,00	75	-	-	-	280,008	325,01	520,015	693,354	975,029	1170,035	2282	2853	4565	6086	8559	10271
M 52x5,00	80	-	-	-	312,056	390,07	624,112	832,149	1170,209	1404,251	2954	3692	5907	7876	11076	13292
M 56x5,50	85	-	-	-	359,843	449,804	719,689	959,581	1349,411	1619,293	3672	4591	7345	9793	13772	16526
M 60x5,50	90	-	-	-	420,651	525,813	841,301	1121,735	1577,44	1892,928	4582	5728	9164	12219	17183	20619
M 64x6,00	95	-	-	-	475,86	594,825	951,72	1268,96	1784,476	2141,371	5536	6920	11071	14762	20759	24911
M 68x6,00	100	-	-	-	545,427	681,784	1090,855	1454,473	2045,353	2454,423	6720	8400	13440	17919	25199	30239

Utahovací momenty pro šrouby DIN 912 podle tříd pevnosti pro přesné závit

Rozměry	Velikost klíče	Nástrčné nářadí			Předpínací síla (kN)						Utahovací moment (Nm)					
					Třída pevnosti						Třída pevnosti					
					4.6	5.6	6.8	8.8	10.9	12.9	4.6	5.6	6.8	8.8	10.9	12.9
M 8x1,00	13	9x12	14x18	-	6,805	8,507	13,611	18,148	25,52	30,624	10,08	12,6	20,15	26,87	37,79	45,35
M 10x1,25	17	9x12	14x18	-	11,418	14,272	22,835	30,447	42,816	51,379	20,83	26,04	41,66	55,55	78,11	93,73
M 12x1,50	19	9x12	14x18	-	15,312	19,14	30,624	40,832	57,42	68,904	34,01	42,51	68,02	90,69	127,54	153,05
M 14x1,50	22	-	14x18	-	21,934	27,418	43,868	58,491	82,253	98,703	56,25	70,32	112,51	150,01	210,96	253,15
M 16x1,50	24	-	14x18	-	29,741	37,177	59,483	79,31	111,53	133,836	86,5	108,12	172,99	230,66	324,36	389,23
M 18x1,50	27	-	14x18	-	38,733	48,417	77,467	103,289	145,25	174,3	125,95	157,44	251,91	335,88	472,33	566,8
M 20x1,50	30	-	14x18	-	48,91	61,138	97,82	130,427	183,413	220,096	175,9	219,8	351,7	468,9	659,4	791,3
M 22x1,50	32	-	14x18	21/26	60,272	75,34	120,543	160,724	226,019	271,223	237,4	296,8	474,8	633,1	890,3	890,3
M 24x2,00	36	-	14x18	21/26	72,818	91,022	145,635	194,18	273,066	327,68	311,8	389,8	623,7	831,6	1169,4	1403,3

Uvedené utahovací momenty jsou směrné hodnoty
Všechny údaje bez záruky



Seřízení/kalibrace

- Momentový klíč HAZET je nutné pravidelně kontrolovat a seřizovat. Kontrola a seřízení jsou doporučeny po cca 5 000 šroubovacích cyklech, nejpozději však po dvanácti měsících.
- Interval mezi termíny kontroly závisí na četnosti používání. K tomuto účelu se hodí zkoušečka HAZET.
- Nemí-li k dispozici vhodná zkoušečka s detekcí bodu zlomu, vezmeme momentový klíč HAZET prostřednictvím vašeho specializovaného prodejce ke kontrole a seřízení do našeho závodu.
- Momentové klíče HAZET a zkoušečky utahovacích momentů HAZET, které jste zaslali společnosti HAZET, obdržíte po přezkoušení a případném nutném seřízení zpět spolu s certifikátem o zkoušce.

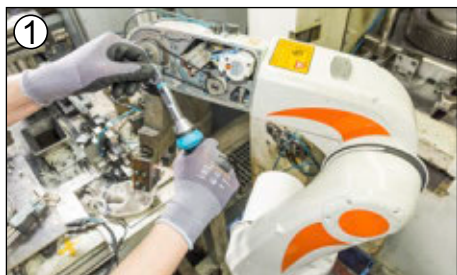

HAZET SERVIS pro momentové klíče a pneumatické nástroje

Všechny momentové a pneumatické nástroje HAZET jsou servisovatelné!

Kromě oprav v servisním centru HAZET nabízíme pro momentové klíče kontroly v závodě až po kalibraci ve vlastní kalibrační laboratoři DAkkS. Ohledně všech výkonů servisního centra HAZET a nabídky servisu na místě Vám rád poradí váš lokální partner HAZET.



SYSTEM 5000 CT

Momentový klíč, s ochrannou izolací

Viz kapitola nářadí s ochrannou izolací / elektrikářské nářadí strana 252



5000-3 CT Momentový klíč · SYSTEM 5000-3 CT (s přepínací ráčnou) · ±3% přesnost · 5107-3 CT 4% · 1–800 Nm

Made in Germany

• Uživatelsky příjemná přepínací ráčna

- **Přesnost ±3 % z hodnoty stupnice** (ve směru utahování) (5107-3 CT ±4 % přesnost z hodnoty stupnice)
- **Bezpečné:**
 - Hapticky (krátký posun při vypnutí)
 - Akusticky (zalamovací prvek)
- Koncipováno pro drsné dílenské nasazení
- Široké spektrum použití pro kontrolované utahování šroubů při servisu pneumatik, jednostopých vozidel, u osobních automobilů, užitkových vozidel a rovněž při různých případech použití v průmyslu a řemesle.
- Optimalizovaný těsnicí kroužek na ochranu před cizími tělesy
- Opravárenská ráčnová sada pro zákazníky orientovanou vlastní montáž umožní použití po desítky let
- Rukojeť s větším záběrem pro snadnější přenos síly
- Nastavovací pomůcka s aretačními body pro optimalizované vedení obsluhy zaručuje bezpečné a rychlé nastavení požadované hodnoty utahovacího momentu otočením rukojeti
- Bezpečné zajištění hodnot nastavení aretační funkcí na otočném věnci
- Otočný věnec ve tvaru trojúhelníku zabraňuje nekontrolovanému odkutálení
- Symboly zámku signalizují příslušný stav zajištění.
- Možnost upevnění pro lankovou smyčku skrz otvory zajišťovacího otočného věnce
- Dobře čitelná kontrastní stupnice
- Trvalá čitelnost díky laserovému popisu pouzdra stupnice
- Integrovaná přepínací páka
- **5121-3 CT – 5123-3 CT:** Přepínací páka s volnoběžnou funkcí – snižuje nebezpečí zranění a poruchy funkce
- Vyzkoušeno podle DIN EN ISO 6789-2:2017
- S osvědčením o kalibraci a sériovým číslem
- Dodávka ve stabilním otočném balení Hexa
- DIN 3120, ISO 1174-1, DIN EN ISO 6789-2:2017

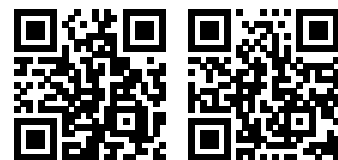

YouTube Clip YouTube Clip

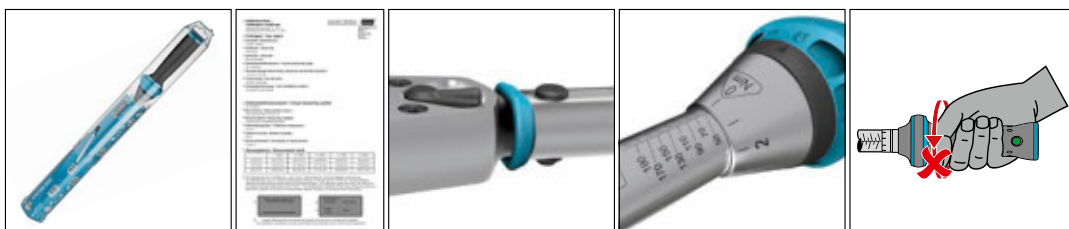
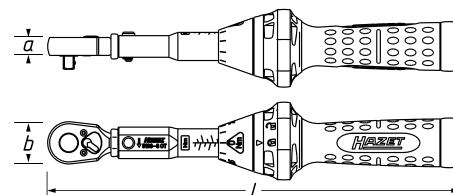

HAZET No.	Výstup	l mm	a mm	b mm	Přesnost vypnutí %	Nm	Nm	kg	EAN-No. 4000896+	€
• Ideální pro práci na jízdních kolech a snímacích tlaku v pneumatikách										
5107-3 CT	■ 6,3 = ¼"	234	10,2	24	4	1–9	0,1	0,6–5,5	218875	185,30
• Ideální pro práci na jednostopých vozidlech										
5108-3 CT	■ 6,3 = ¼"	234	10,2	24	3	2,5–25	0,25	1,4–15,3	218882	185,30
5110-3 CT	■ 10 = ¾"	320	14,5	32	3	10–60	0,5	3,9–25,0	218899	165,20
• Extra krátké provedení – obzvláště kompaktní										
• Speciálně i pro užitková vozidla										
5120-3 CT	■ 12,5 = ½"	320	14,5	32	3	10–60	0,5	3,9–25,0	218905	174,70
• Úzká hlavice ráčny – zvláště se hodí pro použití u motocyklů										
5111-3 CT	■ 10 = ¾"	375	14,5	32	3	20–120	1	6,9–43,5	235384	179,90
5121-3 CT	■ 12,5 = ½"	421	19,6	44	3	20–120	1	6,1–38,0	218912	187,50
5122-3 CT	■ 12,5 = ½"	519	19,6	44	3	40–200	1	9,4–49,5	219001	190,50
5123-3 CT	■ 12,5 = ½"	628	19,6	44	3	60–320	2	11,3–62,2	218998	210,70
• Pro použití s vysokými utahovacími momenty										
– Centrální šrouby nápravy u FIAT Ducato · MERCEDES-BENZ Sprinter										
– Ložiska kol např. u OPEL Movano · PEUGEOT Boxer										
– Třmeny ložisek u zemědělských strojů a trmeny u převodovek užitkových automobilů										
• Díky možnosti použití 12,5 mm (½") nástřných hlav / prodloužení, lze nyní také manipulovat s momentově kontrolovanými šroubeními 100 až 400 Nm ve všech řemeslných a průmyslových oblastech výroby např. se závitů M12 až M16 (třída pevnosti 12.9) nebo M16 až M24 (třída pevnosti 5.6) se zúženými přístupy, např. u přírubových a strojních šroubení										
5143-3 CT	■ 12,5 = ½"	790	28,5	64	3	100–400	2,5	14,8–60,3	235407	575,-
5145-3 CT	■ 20 = ¾"	1271	28,5	64	3	300–800	2,5	26,2–71,0	218929	698,-



Momentová technika

SYSTEM 5000 CT



5200-3 CT Momentový klíč · SYSTEM 5200-3 CT (s nástrčným čtyřhranem) · ±3 % přesnost · 10–200 Nm

Made in Germany

• Zástrčka pro uchycení nástrčného nářadí

- Přesnost ±3 % z hodnoty stupnice (ve směru manipulace)
- Bezpečné:
 - Hapticky (krátký posun při vypnutí)
 - Akusticky (zalamovací prvek)
- Koncipováno pro drsné dílenské nasazení
- Široké spektrum použití pro kontrolované utahování šroubů při servisu pneumatik, dvoukolových aplikacích, u osobních automobilů, užitkových vozidel a rovněž při různých případech použití v průmyslu a řemesle
- Optimalizovaný těsnicí kroužek na ochranu před cizími tělesy
- Rukojeť s větším záběrem pro snadnější přenos síly
- Nastavovací pomůcka s aretačními body pro optimalizované vedení obsluhy zaručuje bezpečné a rychlé nastavení požadované hodnoty utahovacího momentu otočením rukojeti
- Bezpečné zajištění hodnot nastavení aretační funkcí na otočném věnci
- Otočný věnec ve tvaru trojúhelníku zabraňuje nekontrolovanému odkutálení
- Symboly zámku signalizují příslušný stav zajištění
- Možnost upevnění pro lankovou smyčku skrz otvory zajišťovacího otočného věnce
- Dobře čitelná kontrastní stupnice
- Trvalá čitelnost díky laserovému popisu pouzdra stupnice
- Vyzkoušeno podle DIN EN ISO 6789-2:2017
- S osvědčením o kalibraci a sériovým číslem
- Dodávka ve stabilním otočném balení
- DIN EN ISO 6789-2:2017

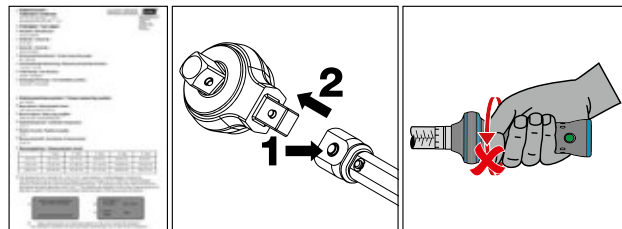
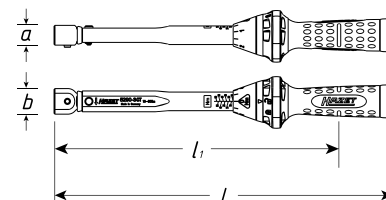

HAZET No.	Výstup	l mm	li mm	a mm	b mm	Přesnost vypnutí %	Nm	Nm		EAN-No. 4000896+	€
5290-3 CT	□ 9x12	291	245	17	22	3	10–60	0,5	3,7–23,4	228904	164,40
5292-3 CT	□ 14x18	484	422	23	30	3	40–200	1	8,9–46,6	228911	179,90





SYSTEM 5000 CLT

5000 CLT Momentový klíč · SYSTEM 5000 CLT · ± 4% přesnost · 20–320 Nm

Made in Germany

• Typ západkové čochky s velkým indikačním displejem v okénku zaručuje bezpečnost uživatele

(E) 12,5 1/2

- ± 4 % přesnost z hodnoty stupnice (ve směru utahování)
- Bezpečné:
 - Hapticky (krátký posun při vypnutí)
 - Akusticky (zalamovací prvek)
- Přepínací ráčna
- Nastavení požadované hodnoty utahovacího momentu rychle a bezpečně otáčením rukojeti
- Otočné tlačítko pro dodatečné zajištění nastavení
- Třímístné, velké číslice pro odečtení nastaveného utahovacího momentu
- S osvědčením o kalibraci a sériovým číslem
- Bezpečné uložení v Safe-Box s průzorem
- Povrch: tvrdochrom
- DIN EN ISO 6789-2:2017, DIN 3120, ISO 1174-1

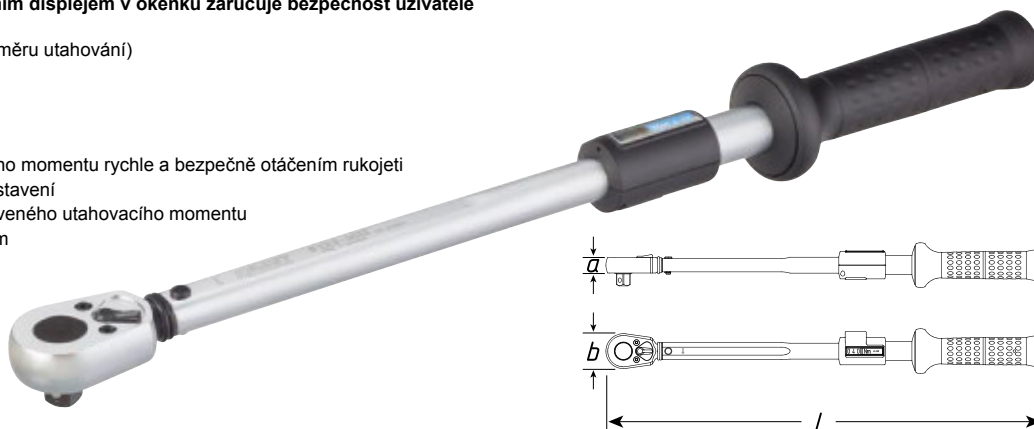

HAZET No.	Výstup	l mm	a mm	b mm	Přesnost vypnutí %	Nm	↘ Nm		EAN-No. 4000896+	€
5121-2 CLT	■ 12,5 = 1/2"	435	19,6	44	4	20–120	1		104215	296,40
5122-2 CLT	■ 12,5 = 1/2"	545	19,6	44	4	40–200	1		104192	307,-
5123-2 CLT	■ 12,5 = 1/2"	660	19,6	44	4	60–320	2		104222	349,30

SYSTEM 6000 CT

6000-1 CT Momentový klíč · SYSTEM 6000 CT · ± 2% přesnost · 6106-1 CT 4% · 1–40 Nm

Made in Germany

(E) 6,3 1/4

- Bezpečné:
 - Hapticky (krátký posun při vypnutí)
 - Akusticky (zalamovací prvek)
- Nastavení požadované hodnoty utahovacího momentu rychle a jistě otočením rukojeti
- Zvláště úzké provedení díky tažnému pouzdru ovládanému pružinou k zablokování nastavitelných hodnot
- Přesnost ± 2 % z hodnoty stupnice (ve směru utahování)
- 6106-1 CT: ± 4 % přesnost z hodnoty stupnice
- Použití v oblasti motorů, převodovek, průmyslu, strojů, staveb modelů
- S osvědčením o kalibraci a sériovým číslem
- DIN EN ISO 6789-2:2017, DIN 3120, ISO 1174-1



360°

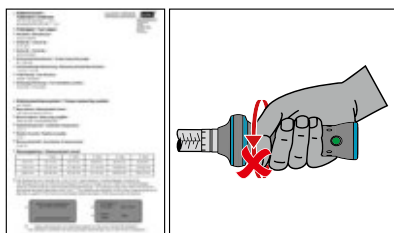
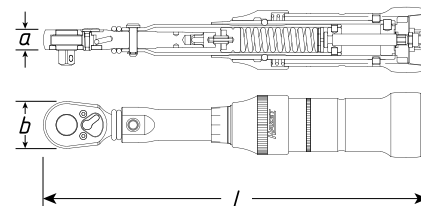

* = 6109-2 CT a 6109-2 CT CAL mimo řadu DIN, protože je překročena v normě 6789-1:2017 uvedená maximální hodnota utahovacího momentu čtyřhranu

HAZET No.	Výstup	l mm	a mm	b mm	Přesnost vypnutí %	Nm	↘ Nm	Signalizační tlačítko		EAN-No. 4000896+	€
6106-1 CT	■ 6,3 = 1/4"	197	10,2	24	4	1–6	0,1	✗		173167	287,70
6108-1 CT	■ 6,3 = 1/4"	198	10,2	24	2	2–10	0,2	✗		062218	297,-
6109-2 CT *	■ 6,3 = 1/4"	256	10,2	24	2	4–40	0,4	✗		080564	323,70
• Momentový klíč včetně kalibračního listu DAkkS											
6106-1 CT CAL	■ 6,3 = 1/4"	197	10,2	24	4	1–6	0,1	✗		192892	515,-
6108-1 CT CAL	■ 6,3 = 1/4"	198	10,2	24	2	2–10	0,2	✗		192908	526,-
6109-2 CT CAL *	■ 6,3 = 1/4"	256	10,2	24	2	4–40	0,4	✗		193318	552,-



Momentová technika

SYSTEM 6000 CT



6000-1 CT Momentový klíč · SYSTEM 6000 CT · ±2 % přesnost · 5–800 Nm

Made in Germany

- ±2 % přesnost z hodnoty stupnice (ve směru utahování)
- Vysoce precizní prvotřídní momentové nástroje – pro nejvyšší nároky
- Robustní a odolná **tvrdě chromovaná** ocelová trubková konstrukce v úzkém provedení
- Bezpečné uložení v Safe-Box s průzorem
- Bezpečné:
 - Hapticky (krátký posun při vypnutí)
 - Akusticky (zalamovací prvek)
 - Opticky (modely se signalizačním tlačítkem)
- Uživatelsky komfortní přepínací ráčna
- **Snadná údržba** (opravné sady pro ráčna určené zákazníkům pro vlastní montáž)
- Integrovaná přepínací páčka
- Nastavení požadované hodnoty utahovacího momentu rychle a bezpečně otáčením rukojeti
- Otočné tlačítko pro dodatečné zajištění nastavení
- Ergonomicky tvarovaná rukojeť s nákrůžkem **snižuje nebezpečí sklouznutí/zranění**
- Přesné jemné dělení stupnice
- 6121-1 CT – 6123-1 CT: Přepínací páka s volnoběžnou funkcí – snižuje nebezpečí zranění a poruchy funkce
- S osvědčením o kalibraci a sériovým číslem
- Povrch: tvrdochrom
- DIN EN ISO 6789-2:2017, DIN 3120, ISO 1174-1

Ⓔ

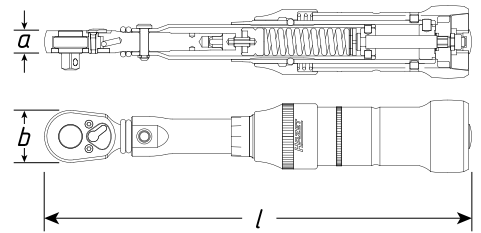

HAZET No.	Výstup	l mm	a mm	b mm	Přesnost vypnutí %	Nm	Nm	Signalizační tlačítko	kg	EAN-No. 4000896+	€
6110-1 CT	■ 10 = 3/8"	335	14,5	32	2	5–60	0,5	✗	1,9–24,7	025022	372,60
6111-1 CT	■ 10 = 3/8"	389	14,5	32	2	20–120	1	✓	6,7–42,4	025077	372,60
6121-1 CT	■ 12,5 = 1/2"	435	19,6	44	2	20–120	1	✓	6,0–37,4	025220	376,20
6122-1 CT	■ 12,5 = 1/2"	543	19,6	44	2	40–200	1	✓	9,0–47,5	025268	421,10
6123-1 CT	■ 12,5 = 1/2"	659	19,6	44	2	60–320	2	✓	10,8–59,6	025367	532,-

- **2komponentní rukojeť** pro lepší úchop
- Zjednodušená aretace pro nastavení hodnoty utahovacího momentu
- Průzor pro optickou kontrolu blokování
- 3 další barevné kódovací kroužky k označení při personalizacích nebo speciálních pracovních postupech
- Bez signalizačního tlačítka

6143-1 CT	■ 20 = 3/4"	802	28,5	64	2	100–400	2,5	✗	14,5–59,2	025466	758,-
6144-1 CT	■ 20 = 3/4"	1046	28,5	64	2	200–500	2,5	✗	21,6–54,6	025541	1008,-
6145-1 CT	■ 20 = 3/4"	1283	28,5	64	2	300–800	2,5	✗	25,9–70,2	025565	1057,-

• Momentový klíč včetně kalibračního listu DAKKS

6110-1 CT CAL	■ 10 = 3/8"	335	14,5	32	2	5–60	0,5	✗	1,9–24,7	192915	603,-
6111-1 CT CAL	■ 10 = 3/8"	389	14,5	32	2	20–120	1	✓	6,7–42,4	193011	603,-
6121-1 CT CAL	■ 12,5 = 1/2"	435	19,6	44	2	20–120	1	✓	6,0–37,4	193028	607,-
6122-1 CT CAL	■ 12,5 = 1/2"	543	19,6	44	2	40–200	1	✓	9,0–47,5	193233	651,-
6123-1 CT CAL	■ 12,5 = 1/2"	659	19,6	44	2	60–320	2	✓	10,8–59,6	193240	760,-

• Momentový klíč včetně kalibračního listu DAKKS

6143-1 CT CAL	■ 20 = 3/4"	802	28,5	64	2	100–400	2,5	✗	14,5–59,2	192922	1079,-
6144-1 CT CAL	■ 20 = 3/4"	1046	28,5	64	2	200–500	2,5	✗	21,6–54,6	193035	1233,-
6145-1 CT CAL	■ 20 = 3/4"	1283	28,5	64	2	300–800	2,5	✗	25,9–70,2	193042	1380,-



6000-1 CT Momentový klíč · SYSTEM 6000 CT · ±3 % přesnost (6170-1 CT 4 %) · 400–2000 Nm

🇩🇪 **Made in Germany**

• Pro nejvyšší hodnoty utahovacího momentu

ⓔ

- **±3 % přesnost z hodnoty stupnice** (ve směru utahování) (6170-1 CT ±4 %)
- Ideální pro průmyslové lezce
- Použití na větrných elektrárnách, v loděnicích, v letectví a těžkém průmyslu, u UV apod.
- Rozložitelný na 2 díly (6170-1 CT 3 díly) s odemkacím nářadím
- Včetně brašny pro bezpečné uložení a nošení v ruce nebo na zádech
- Rychlé šroubování je možné také jen s násadou ráčny, utahování na moment provádějte pouze s kompletním klíčem
- **2komponentní rukojeť** pro lepší úchop
- Zjednodušená aretace pro nastavení hodnoty utahovacího momentu
- Průzor pro optickou kontrolu blokování
- 3 další barevné kódovací kroužky k označení při personalizacích nebo speciálních pracovních postupech
- DIN EN ISO 6789-2:2017, DIN 3120, ISO 1174-1

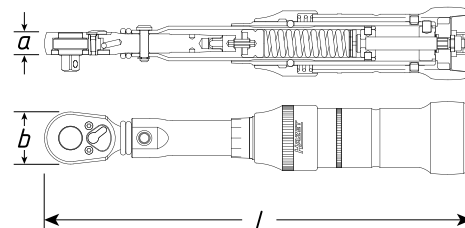

HAZET No.	Výstup	l mm	a mm	b mm	Přesnost vypnutí %	Nm	Nm	Signalizační tlačítko	kg	EAN-No. 4000896+	€
1000Nm momentový klíč Hmotnost jen asi 10 kg											
• Ovládací síla jen 590 N (60 kg) při 1000 Nm											
• Délka násady ráčny 903 mm, rukojeť 930 mm											
6150-1 CT	■ 20 = 3/4"	1789	36	77	3	400–1000	5	✘	24,2–61,0	141067	1392,-
1600Nm momentový klíč Hmotnost jen asi 14 kg											
• Ovládací síla jen 685 N (70 kg) při 1600 Nm											
• Délka násady ráčny 1205 mm, rukojeť 1320 mm											
6160-1 CT	■ 25 = 1"	2455	36	77	3	600–1600	5	✘	26,1–70,1	155316	1678,-
2000Nm momentový klíč Hmotnost jen asi 18 kg											
• Ovládací síla jen 685 N (70 kg) při 2000 Nm											
• Kalibrace podle podnikové normy											
6170-1 CT	■ 25 = 1"	3033	36	77	4	800–2000	6	✘	27,9–70,1	177776	2352,-
• Momentový klíč včetně kalibračního listu DAkkS											
6150-1 CT CAL	■ 20 = 3/4"	1789	36	77	3	400–1000	5	✘	24,2–61,0	193059	1798,-
6160-1 CT CAL	■ 25 = 1"	2455	36	77	3	600–1600	5	✘	26,1–70,1	193066	2085,-



Momentová technika

SYSTEM 6000 CT



6000-1 CT-US Momentový klíč · SYSTEM 6000 CT · US-STANDARD · ±3 % přesnost · 5–600 lbf.ft

Made in Germany

• Podle US-standardu

• Dělení stupnice v lbf.ft

• ±3 % přesnost z hodnoty stupnice (ve směru utahování)

• Bezpečné:

– Hapticky (krátký posun při vypnutí)

– Akusticky (zalamovací prvek)

• Nastavení požadované hodnoty utahovacího momentu rychle a bezpečně otáčením rukojeti

• Přepínací ráčna

• Otočné tlačítko pro dodatečné zajištění nastavení

• 6127-1 CT – 6128-1 CT: Přepínací páka s volnoběžnou funkcí

– snižuje nebezpečí zranění a poruchy funkce

• Bezpečné uložení v Safe-Box s průzorem

• S osvědčením o kalibraci a sériovým číslem

• DIN EN ISO 6789-2:2017, DIN 3120, ISO 1174-1

Ⓔ

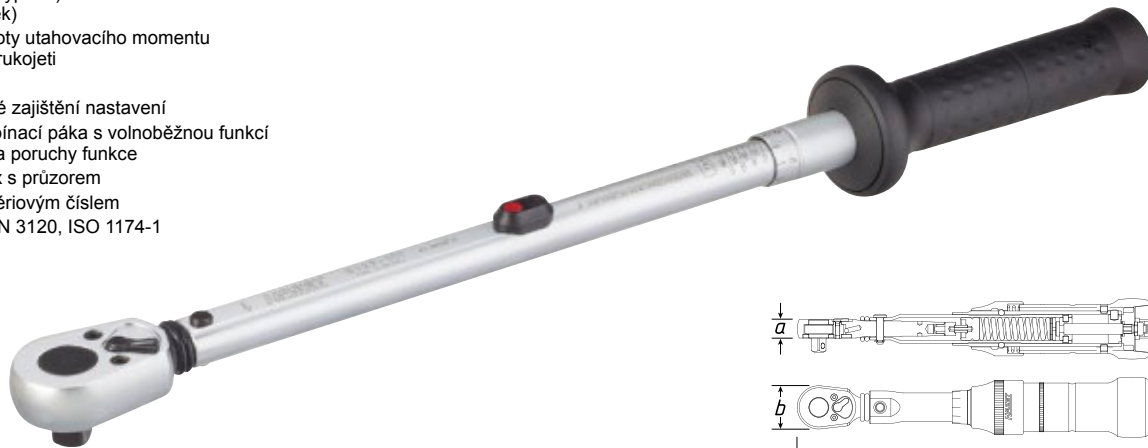

HAZET No.	Výstup	l mm	a mm	b mm	Přesnost vypnutí %	lbf.ft.	Nm	lbf.ft.	Signalizační tlačítko		EAN-No. 4000896+	€
6114-1 CT	■ 10 = 3/8"	333	14,5	32	3	5–40	6,8–54,2	0,5	✗	2,6–21,8	078424	301,20
6115-1 CT	■ 10 = 3/8"	390	14,5	32	3	20–100	27,1–135,6	0,5	✓	9,1–48,2	025084	370,30
6127-1 CT	■ 12,5 = 1/2"	545	19,6	44	3	40–200	54,2–271,2	1	✓	12,3–64,6	025381	421,10
6128-1 CT	■ 12,5 = 1/2"	660	19,6	44	3	50–250	67,8–339	2	✓	12,2–62,6	076116	532,-

• 2komponentní rukojeť pro lepší úchop

• Zjednodušená aretace pro nastavení hodnoty utahovacího momentu

• Průzor pro optickou kontrolu blokování

• 3 další barevné kódovací kroužky k označení při personalizacích nebo speciálních pracovních postupech

• Bez signalizačního tlačítka

6132-1 CT	■ 20 = 3/4"	1284	28,5	64	3	120–600	162,7–813,5	2	✗	14,0–71,6	078455	1214,-
-----------	-------------	------	------	----	---	---------	-------------	---	---	-----------	--------	--------





6200-1 CT Momentový klíč · SYSTEM 6000 CT · ±2 % přesnost · 2–40 Nm

Made in Germany

- Zástrčka pro uchycení nástrčného nářadí
- **Přesnost ±2 % z hodnoty stupnice** (ve směru utahování)
- Bezpečné:
 - Hapticky (krátký posun při vypnutí)
 - Akusticky (zalamovací prvek)
- S osvědčením o kalibraci a sériovým číslem
- Zvláště úzké provedení díky tažnému pouzdru ovládanému pružinou k zablokování nastavitelných hodnot
- Nastavení požadované hodnoty utahovacího momentu rychle a bezpečně otáčením rukojeti
- DIN EN ISO 6789-2:2017

E 9 x 12

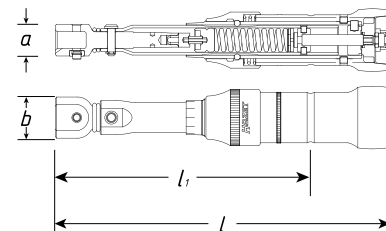
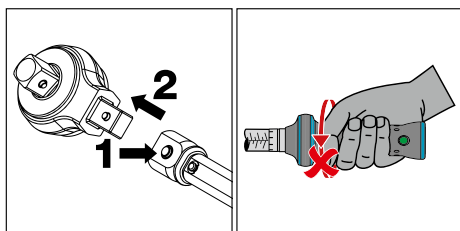

* = 6282-1 CT a 6282-1 CT CAL mimo řadu DIN, protože je překročena v normě 6789-1:2017 uvedená maximální hodnota utahovacího momentu čtyřhranu

HAZET No.	Výstup	l mm	l_1 mm	a mm	b mm	Přesnost vypnutí %	Nm	Nm	Signalizační tlačítko		EAN-No. 4000896+	€
6280-1 CT	<input type="checkbox"/> 9x12	181	141	17	22	2	2–10	0,2	✗	1,3–6,6	026005	242,50
6282-1 CT *	<input type="checkbox"/> 9x12	240	200	17	22	2	4–40	0,4	✗	1,9–19,8	080540	264,-
• Momentový klíč včetně kalibračního listu DAkkS												
6280-1 CT CAL	<input type="checkbox"/> 9x12	181	141	17	22	2	2–10	0,2	✗	1,3–6,6	193073	469,20
6282-1 CT CAL *	<input type="checkbox"/> 9x12	240	200	17	22	2	4–40	0,4	✗	1,9–19,8	193080	490,90

6200-1 CT Momentový klíč · SYSTEM 6000 CT · ±4 % přesnost · 5–13 Nm

Made in Germany

- **Obzvlášť krátká konstrukce pro úzké prostory**

9 x 12

- Zástrčka pro uchycení nástrčného nářadí
- **Přesnost ± 4 % z hodnoty stupnice** (ve směru utahování)
- Povrch: tvrdochrom
- DIN EN ISO 6789-2:2017

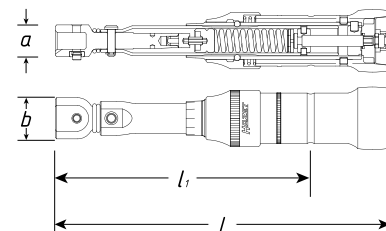
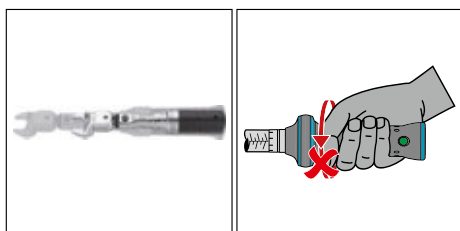

HAZET No.	Výstup	l mm	l_1 mm	a mm	b mm	Přesnost vypnutí %	Nm	Nm	Signalizační tlačítko		EAN-No. 4000896+	€
6281-2 CT	<input type="checkbox"/> 9x12	125,4	99	17	22	4	5–13	0,2	✗	4,4–11,8	183326	248,60
• Momentový klíč včetně kalibračního listu DAkkS												
6281-2 CT CAL	<input type="checkbox"/> 9x12	125,4	99	17	22	4	5–13	0,2	✗	4,4–11,8	193295	475,30



Momentová technika

SYSTEM 6000 CT



6200-1 CT Momentový klíč · SYSTEM 6000 CT · ±2 % přesnost · 5–320 Nm

Made in Germany

- Zástrčka pro uchycení nástrčného nářadí
- **Přesnost ±2 % z hodnoty stupnice** (ve směru utahování)
- Bezpečné:
 - Hapticky (krátký posun při vypnutí)
 - Akusticky (zalamovací prvek)
- S osvědčením o kalibraci a sériovým číslem
- Nastavení požadované hodnoty utahovacího momentu rychle a bezpečně otáčením rukojeti
- Bezpečné uložení v Safe-Box s průzorem
- DIN EN ISO 6789-2:2017

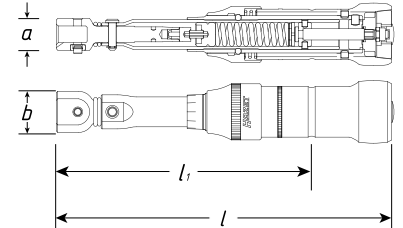
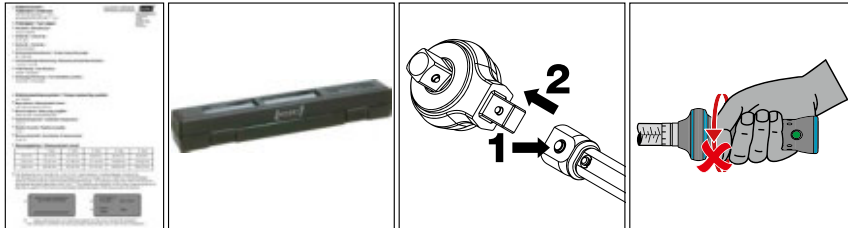

HAZET No.	Výstup	l mm	li mm	a mm	b mm	Přesnost vypnutí %	Nm	Nm	Signalizační tlačítko	EAN-No. 4000896+	€	
6290-1 CT	□ 9x12	306	252	17	22	2	5–60	0,5	✗	1,8–23,1	026043	318,40
6291-2 CT	□ 9x12	389	318	18	23	2	20–120	1	✓	5,9–36,6	026104	318,40
6291-1 CT	□ 14x18	401	330	23	30	2	20–120	1	✓	5,5–34,5	026074	326,20
6292-1 CT	□ 14x18	511	440	23	30	2	40–200	1	✓	8,5–44,8	026135	371,50
6293-1 CT	□ 14x18	625	554	23	30	2	60–320	2	✓	10,3–56,8	026173	480,10
• Momentový klíč včetně kalibračního listu DAkkS												
6290-1 CT CAL	□ 9x12	306	252	17	22	2	5–60	0,5	✗	1,8–23,1	193097	547,-
6291-2 CT CAL	□ 9x12	389	318	18	23	2	20–120	1	✓	5,9–36,6	193257	547,-
6291-1 CT CAL	□ 14x18	401	330	23	30	2	20–120	1	✓	5,5–34,5	193264	554,-
6292-1 CT CAL	□ 14x18	511	440	23	30	2	40–200	1	✓	8,5–44,8	193271	602,-
6293-1 CT CAL	□ 14x18	625	554	23	30	2	60–320	2	✓	10,3–56,8	193288	710,-

6200-1 CT Momentový klíč · SYSTEM 6000 CT · ±2 % přesnost · 100–500 Nm

Made in Germany

- Zástrčka pro uchycení nástrčného nářadí
- **Přesnost ±2 % z hodnoty stupnice** (ve směru utahování)
- Bezpečné:
 - Hapticky (krátký posun při vypnutí)
 - Akusticky (zalamovací prvek)
- S osvědčením o kalibraci a sériovým číslem
- Nastavení požadované hodnoty utahovacího momentu rychle a bezpečně otáčením rukojeti
- Bezpečné uložení v Safe-Box s průzorem
- **2komponentní rukojeť** pro lepší úchop
- Zjednodušená aretace pro nastavení hodnoty utahovacího momentu
- Průzor pro optickou kontrolu blokování
- Otočné tlačítko pro dodatečné zajištění nastavení
- 3 další barevné kódovací kroužky k označení při personalizacích nebo speciálních pracovních postupech
- Bez signalizačního tlačítka
- DIN EN ISO 6789-2:2017

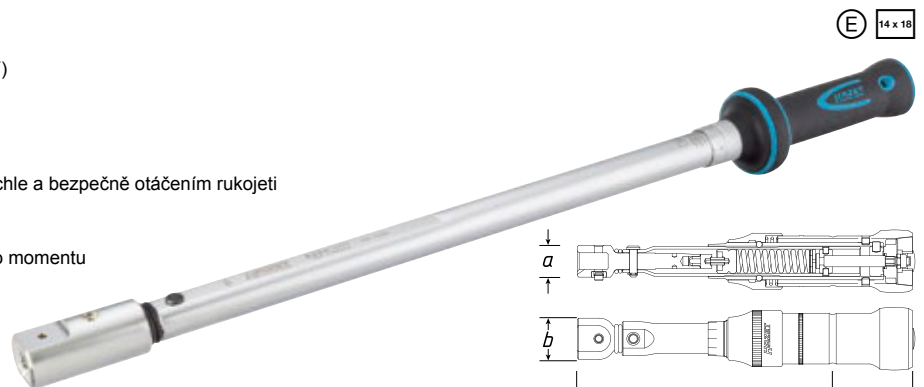

HAZET No.	Výstup	l mm	li mm	b mm	Přesnost vypnutí %	Nm	Nm	Signalizační tlačítko	EAN-No. 4000896+	€	
6294-1 CT	□ 14x18	718	649	35,5	2	100–400	2,5	✗	14,7–59,9	026197	680,-
6295-1 CT	□ 14x18	962	893	35,5	2	200–500	2,5	✗	21,8–55,1	026203	1080,-
• Momentový klíč včetně kalibračního listu DAkkS											
6294-1 CT CAL	□ 14x18	718	649	35,5	2	100–400	2,5	✗	14,7–59,9	193103	1001,-
6295-1 CT CAL	□ 14x18	962	893	35,5	2	200–500	2,5	✗	21,8–55,1	193110	1404,-



6290 Sada momentového nářadí

Made in Germany

- Kovová schránka (modrá HAZET)
- 2komponentní měkká pěnová vložka



6200-1 CT •
 6290-1 CT



6450 C •
 7 • 8 • 9 • 10 • 11 • 12
 13 • 14 • 15 • 16 • 17



6630 C •
 7 • 8 • 10 • 11 • 12
 13 • 14 • 15 • 16 • 17



6402-1 • •



6612 C •
 10 • 11 • 12 • 13 • 14 • 17

HAZET No.	d x š x v mm		EAN-No. 4000896+	€
6290-1 CT/29	435x215x62	29	026067	1488,-

6292 Sada momentového nářadí

Made in Germany

- Kovová schránka (modrá HAZET)
- 2komponentní měkká pěnová vložka



6200-1 CT •
 6292-1 CT



6404-1 • •



6450 D •
 13 • 14 • 15 • 16
 17 • 18 • 19 • 21
 22 • 24 • 27 • 30
 32



6630 D •
 13 • 14 • 15 • 16
 17 • 18 • 19 • 21
 22 • 24 • 27 • 30
 32

HAZET No.	d x š x v mm		EAN-No. 4000896+	€
6292-1 CT/28	578x235x88	28	026166	1785,-

6400 Sadu nástrčného nářadí

Made in Germany

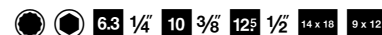

6401-1 • •



6413-4 • •



6612 C •
 10 • 14 • 19 • 22



6402-1 • •



6414 • •



6630 C •
 8 • 10 • 11 • 12
 13 • 14 • 15 • 16



6404-1 • •



6423 C • •



6630 D •
 13 • 16 • 17 • 18 • 19
 21 • 22 • 24 • 27



6408 • •



6450 D •
 24

HAZET No.		EAN-No. 4000896+	€
6400 CD/29	29	233458	920,-

Opatřeni? – Žádný problém!

- Nářadí HAZET je vyrobeno v nejvyšší kvalitě. Při dlouhém, intenzivním namáhání dochází i u vysoce kvalitních nástrojů k určitému opotřeben.
- Proto nabízíme pro mnoho našich nástrojů náhradní díly a sady náhradních dílů.

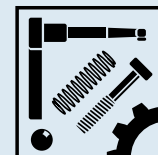

Nezapomeňte na náš obchod s náhradními díly www.hazet.de/ersatzteil-shop

Úspora nákladů – udržitelnost – šetří zdroje!
Abyste se mohli ze svého nářadí HAZET dlouho těšit



6100 Sada náhradních dílů

Made in Germany

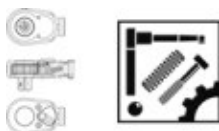

HAZET No.	EAN-No. 4000896+	€
<p>• Sada náhradních dílů otočného zajištění se skládá z: otočného zajištění · uzamykací pružiny a šroubu s válcovou hlavou Pro momentové klíče HAZET r. v. 2014 → 6132-1 CT · 6143-1 CT · 6144-1 CT · 6145-1 CT · 6150-1 CT · 6160-1 CT · 6170-1 CT · 6243-1 CT · 6244-1 CT · 6245-1 CT · 6146-1 CT · 6246-1 CT · 6294-1 CT · 6295-1 CT · 6296-1 CT</p>		
6144-02/3	192557	8,05
<p>• Sada náhradních dílů ovládací páky obsah sady: ovládací páka · šrouby · kulička · tlačná pružina Pro přepínací ráčnu HAZET 1016 · 1016/2 Pro momentový klíč HAZET 5145-3 CT · 6132-1 CT · 6143 CT · 6143-1 CT · 6144 CT · 6144-1 CT · 6145 CT · 6145-1 CT · 6146-1 CT</p>		
1016/6	001972	3,85
<p>• Sada náhradních dílů kolečka ráčny 20 = 3/4" ■, obsah sady: kolečko ráčny · fixační prvek · ovládací páka · šrouby · kulička · tlačná pružina Pro přepínací ráčnu HAZET 1016 · 1016/2 Pro momentové klíče HAZET 5145-3 CT · 6132-1 CT · 6143 CT · 6143-1 CT · 6144 CT · 6144-1 CT · 6145 CT · 6145-1 CT · 6146-1 CT</p>		
1016/8 N	001989	55,-
<p>• Sada náhradních dílů ovládací páky obsah sady: ovládací páka · šrouby · kulička · tlačná pružina Pro přepínací ráčnu HAZET 1116 Pro momentové klíče HAZET 6150-1 CT · 6160-1 CT · 6170-1 CT · 7250-2 sTAC · 7250-5 sTAC</p>		
1116/6	003228	5,-
<p>• Sada náhradních dílů kolečka ráčny 25 = 1" ■, obsah sady: ovládací páka · šrouby · kulička · tlačná pružina · fixační prvek · kolečko ráčny Pro přepínací ráčnu HAZET 1116 Pro momentové klíče HAZET 6160-1 CT · 6170-1 CT</p>		
1116/8 N	003235	65,90
<p>• Sada náhradních dílů ovládací páky obsah sady: ovládací páka · šrouby · kulička · tlačná pružina · fixační prvek Pro přepínací ráčnu HAZET 8816 G · 8816 GK · 8816 P · 8816 S · 8816 ST 916 K · 2264-1 Pro momentový klíč HAZET 5110-2 CT · 5120-2 CT · 5110-3 CT · 5111-3 CT · 5120-3 CT · 6110 CT · 6110-1 CT · 6111-1 CT · 6114-1 CT · 6115-1 CT · 6402-1 · 6402-1 S · 6408-1</p>		
8816 P/6	144617	8,15
<p>• Sada náhradních dílů kolečka ráčny 10 = 3/8" ■, obsah sady: kolečko ráčny · fixační prvek · ovládací páka · šrouby · kulička · tlačná pružina Pro přepínací ráčnu HAZET 8816 G · 8816 GK · 8816 P · 8816 ST Pro momentové klíče HAZET 5110-2 CT · 5110-3 CT · 5111-3 CT · 6110 CT · 6110-1 CT · 6111-1 CT · 6114-1 CT · 6115-1 CT · 6402-1</p>		
8816 P/7 N	042234	20,85
<p>• Sada náhradních dílů kolečka ráčny 12,5 = 1/2" ■, obsah sady: kolečko ráčny · fixační prvek · ovládací páka · šrouby · kulička · tlačná pružina · pérová podložka · pojistný kroužek Pro momentové klíče HAZET 5121-2 CT · 5122-2 CT · 5123-2 CT · 5121-3 CT · 5122-3 CT · 5123-3 CT · 5121-2 CLT · 5122-2 CLT · 5123-2 CLT · 5128-2 CLT · 5122 ST-1 · 6121 CT · 6122 CT · 6123 CT · 6121-1 CT · 6122-1 CT · 6123-1 CT · 6127-1 CT · 6128-1 CT · 6722 TAC</p>		
6122/9 N	025343	29,45
<p>• Sada náhradních dílů kolečka ráčny 12,5 = 1/2" ■, obsah sady: kolečko ráčny · fixační prvek · ovládací páka · šrouby · kulička · tlačná pružina Pro momentové klíče HAZET 5120-2 CT · 5120-3 CT</p>		
5120/7	235490	16,65
<p>• Sada náhradních dílů kolečka ráčny 20 = 3/4" ■, obsah sady: kolečko ráčny · fixační prvek · ovládací páka · šrouby · kulička · tlačná pružina Pro 6150-1 CT · 7250-2 sTAC · 7250-5 sTAC</p>		
6150/8	151431	69,45
<p>• Sada náhradních dílů ovládací páky obsah sady: ovládací páka · šrouby · kulička · tlačná pružina Pro momentové klíče HAZET 5107-2 CT · 5107-3 CT · 5108-2 CT · 5108-3 CT · 6106-1 CT · 6108-1 CT · 6109-1 CT · 6109-2 CT · 6401-1 · 6401-1 S · 6408</p>		
6401-1/6	146048	12,85

6100 Sada náhradních dílů



HAZET No.	EAN-No. 4000896+	€
<p>• Sada náhradních dílů kolečka ráčny 6,3 = 1/4" ■, obsah sady: kolečko ráčny · fixační prvek · ovládací páka · šrouby · kulička · tlačná pružina Pro momentové klíče HAZET 5107-2 CT · 5107-3 CT · 5108-2 CT · 5108-3 CT · 6108-1 CT · 6109-1 CT · 6109-2 CT · 6401-1</p>		
6401/7	111169	17,90
<p>• Sada náhradních dílů kolečka ráčny 6,3 = 1/4" ■, obsah sady: kolečko ráčny se spouštěcím tlačítkem · fixační prvek · ovládací páka · šrouby · kulička · tlačná pružina Pro 6401-1 S a k přestavení nástrčných přepínacích ráčen 5107-2 CT · 5107-3 CT · 5108-2 CT · 5108-3 CT · 6106-1 CT · 6108-1 CT · 6109-2 CT</p>		
6401-1 S/7	111152	25,10
<p>• Sada náhradní ovládací páky obsah sady: ovládací páka · 2 šrouby · kulička · tlačná pružina · pružná podložka a pojistný kroužek Pro nástrčnou přepínací ráčnu HAZET 6403-1 · 6403-1 S · 6404-1 · 6404-1 S</p>		
6403-1/7	070756	13,55
<p>• Sada náhradních dílů kolečka ráčny 12,5 = 1/2" ■, obsah sady: kolečko ráčny · fixační prvek · ovládací páka · šrouby · kulička · tlačná pružina · pružná podložka · pojistný kroužek Pro 6403-1 · 6404-1</p>		
6403-1/9	070749	32,40
<p>• Sada náhradních dílů kolečka ráčny 12,5 = 1/2" ■, obsah sady: kolečko ráčny se spouštěcím tlačítkem · fixační prvek · ovládací páka · šrouby · kulička · tlačná pružina · pružná podložka · pojistný kroužek Pro 6403-1 S · 6404-1 S</p>		
6403-1 S/9	070817	51,50
<p>• Náhradní sada otočného zajištění se skládá z: uzamykací pružiny · otočného zajištění se 2 závitovými kolíky Pro momentové klíče HAZET 6010-1 CT · 6110-1 CT · 6114-1 CT · 6290-1 CT</p>		
6110-2/7	025053	5,90
<p>• Sada náhradních dílů otočného zajištění se skládá z: uzamykací pružiny · otočného zajištění se 2 závitovými kolíky Pro momentové klíče HAZET 5121-2 CLT · 5122-2 CLT · 5123-2 CLT · 5128-2 CLT · 6021-1 CT · 6022-1 CT · 6023-1 CT · 6111-1 CT · 6115-1 CT · 6121-1 CT · 6122-1 CT · 6123-1 CT · 6127-1 CT · 6128-1 CT · 6291-1 CT · 6292-1 CT · 6293-1 CT · 6722 TAC · 6291-2 CT</p>		
6122-2/7	025299	6,40
<p>• Sada náhradních dílů optického vysílače signálu obsahující: červené tlačítko · přitlačnou pružinu · černou skříňku · kolík · šroub Pro momentové klíče HAZET 6021-1 CT · 6022-1 CT · 6023-1 CT · 6110 CT · 6110-1 CT · 6111-1 CT · 6114-1 CT · 6115-1 CT · 6121 CT · 6121-1 CT · 6122 CT · 6122-1 CT · 6123 CT · 6123-1 CT · 6127-1 CT · 6128-1 CT · 6291-1 CT · 6291-2 CT · 6290-1 CT · 6291 CT · 6292-1 CT · 6293-1 CT</p>		
6122-2/9	025305	8,55
<p>• Sada náhradních dílů ovládací páky obsah sady: ovládací páka · šrouby · kulička · tlačná pružina · pružná podložka · pojistný kroužek Pro momentové klíče HAZET 5121-2 CLT · 5121-2 CT · 5121-3 CT · 5122-2 CLT · 5122-2 CT · 5122-3 CT · 5122 ST-1 · 5123-2 CLT · 5123-2 CT · 5123-3 CT · 5128-2 CLT · 6121-1 CT · 6121 CT · 6122-1 CT · 6122 CT · 6123-1 CT · 6123 CT · 6127-1 CT · 6128-1 CT · 6722 TAC</p>		
6122/7	025329	13,75
<p>• Přepínací ráčna se šroubem kompletní vyměnitelná: ■ 20 = 3/4" r. v. → konec roku 2004 Pro momentové klíče HAZET 6132-1 CT · 6143 CT · 6143-1 CT · 6144 CT · 6144-1 CT · 6145 CT · 6145-1 CT · 6146-1 CT</p>		
6143-01	111190	167,80
<p>• Sada náhradních dílů otočného zajištění se skládá z: otočného zajištění · uzamykací pružiny a šroubu s válcovou hlavou Pro momentové klíče HAZET r. v. → 2013 6132-1 CT · 6143-1 CT · 6144-1 CT · 6145-1 CT · 6150-1 CT · 6160-1 CT · 6170-1 CT · 6243-1 CT · 6244-1 CT · 6245-1 CT · 6146-1 CT · 6246-1 CT · 6294-1 CT · 6295-1 CT · 6296-1 CT</p>		
6144-01/3	025527	8,20
<p>• Přepínací ráčna se šroubem kompletní vyměnitelná: ■ 20 = 3/4" r. v. 2005 → Pro momentové klíče HAZET 5145-3 CT · 6132-1 CT · 6144 CT · 6144-1 CT · 6145 CT · 6145-1 CT · 6146-1 CT</p>		
6145-01	111206	176,-



SYSTÉM 7000 sTAC

7000 STAC Momentový / úhlový klíč · elektronický · SmartTAC SYSTEM 7000 sTAC · 1–1000 Nm

Made in Germany

• Technologie Smart – Ready for Industrie 4.0

• HAZET technologie Smart skládající se z aplikace SmartTAC a rozhraní Low Energy Bluetooth 4.1 (skupina produktů 7000-2 sTAC – může podléhat národním omezením schválení) s bezproblémovou live výměnou dat pro zobrazení průběhu šroubování na mobilních koncových zařízeních jako Smartphone (smartwatch) a tabletu či PC, jakož i přes rozhraní USB-C k programování momentového úhlového klíče a dokumentování dat šroubování přes notebook a PC. Všechny sTAC momentové úhlové klíče lze používat také samostatně, bez aplikace SmartTAC

• Jedinečný ergonomický, na uživatele orientovaný design HAZET veškerého nářadí pro profesionální použití

• Zmenšením konstrukční velikosti a rovněž integrací desky do hlavní trubky vznikly rozměry, které vůbec poprvé umožňují malý momentový / úhlový klíč od 1 Nm

• Třída ochrany IP 40

• Displej a fóliová klávesnice chráněné proti stříkající vodě

• USB-C rozhraní k programování momentového / úhlového klíče a k dokumentování dat šroubování přes notebook a PC

• Včetně běžně prodejného, výměnného akumulátoru Li-Ion, typ 14650 / 3,7 voltu, který lze nabíjet přímo na nástroji přes konektor USB-C

• Včetně 1 metru USB 3.1 / A-C kabelu

Funkce: 7000 sTAC

• Velký, kontrastně svítící, dobře čitelný displej OLED, stmívací a otočný o 180°

• Indikace naměřené hodnoty písmem o velikosti 13 mm vč. OK/NOK hodnocení šroubového spoje

• Odchylna indikace utahovacího momentu vpravo a vlevo: od $\pm 1\%$ / ± 1 digitálně

• Odchylna indikace úhlu otočení vpravo a vlevo: $\pm 1\%$ / $\pm 1^\circ$

• Rozsah úhlu otáčení sečteno: 0 až 999°

• Tolerance úhlu otočení pro indikaci OK (zelená): Nastavitelná ± 1 až 10%

• Tolerance úhlu otočení pro indikaci OK (zelená): Nastavitelná 1 až 90°

• Nastavitelné jednotky utahovacího momentu: Nm, lbf ft, lbf in nebo kgf m

• Účinná délka jiného nástrčného nářadí nastavitelná/programovatelná 0 až 250 mm (předpoklad pro korektní měření utahovacího momentu / úhlu otáčení)

• 4násobná signalizace průběhu utahování akustickým signálem (bzučák), vibracemi, pohyblivým číslicovým ukazatelem a z každé polohy viditelnou 360° LED indikací s „funkcí semaforu“

• Prahová hodnota, předběžný výstražný stupeň: Nastavitelný 50 až 99%

• Nastavitelná signalizace, Zap / Vyp akustický signál (bzučák) a vibrace

• Funkce resetu, návrat na tovární nastavení

• Doba stand-by: Nastavitelná 1 až 10 min.

• Zobrazení stavu baterie a paměti

• Paměť včetně data a času: Až pro 3000 měření

• Možnost programování parametrů a postupů: 25 a 25

• 2 kontrolní funkce: Programovatelná kontrola utahovacího momentu při úhlovém utahování a kontrola úhlu při momentovém utahování

• Funkce zablokování menu před nepovolenou změnou nastavených hodnot s volitelným čtyřmístným kódem

• Zobrazení verze softwaru se sériovým číslem, datem kalibrace a ukazatelem servisu / počítadlem použití

• Jazyky menu: Němčina, angličtina, francouzština, italština, čínština

• Volitelné: Programovací a vyhodnocovací software pro notebook a PC

• Aplikace SmartTAC pro koncová zařízení Android a

Apple iOS pro konstrukční řadu 7000-2 sTAC

• Momentové / úhlové klíče SmartTAC **konstrukční řady 7000-2 sTAC s rozhraním Bluetooth** mají platné rádiové schválení ve všech zemích EU, ve Švýcarsku, v Norsku, v Číně, v Indii, v Jižní Koreji a v Turecku a smějí se tam prodávat. Rádiová schválení pro Mexiko, Jižní Afriku, USA a Kanadu se aktuálně připravují. Další země na vyžádání.

• Pro země bez rádiového schválení nabízíme možnost získat momentové / úhlové klíče SmartTAC **konstrukční řady 7000-5 sTAC bez rozhraní Bluetooth**. Ty lze přes připojení USB připojit k notebooku a PC a spojit s volitelným programovatelným a vyhodnocovacím softwarem. Použití aplikace SmartTAC pro mobilní koncová zařízení není možné z důvodu chybějícího rozhraní Bluetooth.

• **S funkcí Bluetooth**

• Přesnost spuštění dle DIN EN ISO 6789-2:2017



SYSTEM 7000 sTAC



YouTube Clip

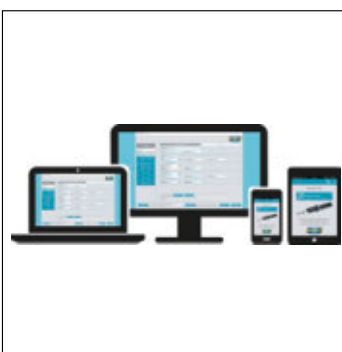



Momentová technika

SYSTÉM 7000 sTAC



7000 STAC Momentový / úhlový klíč · elektronický · SmartTAC SYSTEM 7000 sTAC · 1 – 1000 Nm

HAZET No.	Výstup	l / mm	Přesnost vypnutí %	lbf.ft.	Nm		Rozhraní Bluetooth	EAN-No. 4000896+	€
<ul style="list-style-type: none"> • Včetně přepínací nástrčné ráčny 6401-1 ■ 6,3 = 1/4" • Délka s/bez nástrčného nářadí: 290,5 mm / 260 mm 									
7280-5 sTAC	□ 9x12, ■ 6,3 = 1/4"	260	2	0,75–7,5	1–10	0,5–4,6	✗	223183	1684,-
7281-5 sTAC	□ 9x12, ■ 6,3 = 1/4"	260	2	1,85–18,5	2,5–25	1,1–11,4	✗	223176	1684,-
<ul style="list-style-type: none"> • Včetně přepínací nástrčné ráčny 6402-1 ■ 10 = 3/8" • Délka s/bez nástrčného nářadí: 347 mm / 302 mm 									
7290-5 sTAC	□ 9x12, ■ 10 = 3/8"	302	1	3,5–44	5–60	1,8–22,2	✗	223169	1733,-
<ul style="list-style-type: none"> • Včetně přepínací nástrčné ráčny 6402-1 ■ 10 = 3/8" • Délka s/bez nástrčného nářadí: 428 mm / 383 mm 									
7291-5 sTAC	□ 9x12, ■ 10 = 3/8"	383	1	7,5–75	10–100	2,9–28,7	✗	223152	1792,-
<ul style="list-style-type: none"> • Včetně přepínací nástrčné ráčny 6404-1 ■ 12,5 = 1/2" • Délka s/bez nástrčného nářadí: 578,5 mm / 520 mm 									
7292-5 sTAC	□ 14x18, ■ 12,5 = 1/2"	520	1	15–150	20–200	4,1–40,7	✗	223145	1847,-
<ul style="list-style-type: none"> • Včetně přepínací nástrčné ráčny 6406 ■ 20 = 3/4" • Délka s/bez nástrčného nářadí: 1021 mm / 945 mm 									
7294-5 sTAC	□ 14x18, ■ 20 = 3/4"	945	1	30–300	40–400	4,4–43,8	✗	223138	2269,-
<ul style="list-style-type: none"> • Včetně přepínací nástrčné ráčny 6406 ■ 20 = 3/4" • Délka s/bez nástrčného nářadí: 1217 mm / 1141 mm 									
7295-5 sTAC	□ 14x18, ■ 20 = 3/4"	1141	1	48–480	65–650	5,9–58,7	✗	222926	2336,-
<ul style="list-style-type: none"> • Integrovaná přepínací ráčna ■ 20 = 3/4" 									
7250-5 sTAC	■ 20 = 3/4"	1772	1	150–750	200–1000	12,2–60,8	✗	222919	2631,-
<ul style="list-style-type: none"> • Včetně přepínací nástrčné ráčny 6401-1 ■ 6,3 = 1/4" • Délka s/bez nástrčného nářadí: 290,5 mm / 260 mm 									
7280-2 sTAC	□ 9x12, ■ 6,3 = 1/4"	260	2	0,75–7,5	1–10	0,5–4,6	✓	215294	1700,-
7281-2 sTAC	□ 9x12, ■ 6,3 = 1/4"	260	2	1,85–18,5	2,5–25	1,1–11,4	✓	215317	1700,-
<ul style="list-style-type: none"> • Včetně přepínací nástrčné ráčny 6402-1 ■ 10 = 3/8" • Délka s/bez nástrčného nářadí: 347 mm / 302 mm 									
7290-2 sTAC	□ 9x12, ■ 10 = 3/8"	302	1	3,5–44	5–60	1,8–22,2	✓	215324	1748,-
<ul style="list-style-type: none"> • Včetně přepínací nástrčné ráčny 6402-1 ■ 10 = 3/8" • Délka s/bez nástrčného nářadí: 428 mm / 383 mm 									
7291-2 sTAC	□ 9x12, ■ 10 = 3/8"	383	1	7,5–75	10–100	2,9–28,7	✓	215430	1809,-
<ul style="list-style-type: none"> • Včetně přepínací nástrčné ráčny 6404-1 ■ 12,5 = 1/2" • Délka s/bez nástrčného nářadí: 578,5 mm / 520 mm 									
7292-2 sTAC	□ 14x18, ■ 12,5 = 1/2"	520	1	15–150	20–200	4,1–40,7	✓	215447	1862,-
<ul style="list-style-type: none"> • Včetně přepínací nástrčné ráčny 6406 ■ 20 = 3/4" • Délka s/bez nástrčného nářadí: 1021 mm / 945 mm 									
7294-2 sTAC	□ 14x18, ■ 20 = 3/4"	945	1	30–300	40–400	4,4–43,8	✓	215454	2285,-
<ul style="list-style-type: none"> • Včetně přepínací nástrčné ráčny 6406 ■ 20 = 3/4" • Délka s/bez nástrčného nářadí: 1217 mm / 1141 mm 									
7295-2 sTAC	□ 14x18, ■ 20 = 3/4"	1141	1	48–480	65–650	5,9–58,7	✓	215461	2351,-
<ul style="list-style-type: none"> • Integrovaná přepínací ráčna ■ 20 = 3/4" 									
7250-2 sTAC	■ 20 = 3/4"	1772	1	150–750	200–1000	12,2–60,8	✓	215478	2646,-
<ul style="list-style-type: none"> • Momentový klíč včetně kalibračního listu DAkkS • Včetně přepínací nástrčné ráčny 6401-1 ■ 6,3 = 1/4" • Délka s/bez nástrčného nářadí: 290,5 mm / 260 mm 									
7280-2 sTAC CAL	□ 9x12, ■ 6,3 = 1/4"	260	2	0,75–7,5	1–10	0,5–4,6	✓	220359	2106,-
7281-2 sTAC CAL	□ 9x12, ■ 6,3 = 1/4"	260	2	1,85–18,5	2,5–25	1,1–11,4	✓	220366	2106,-
<ul style="list-style-type: none"> • Momentový klíč včetně kalibračního listu DAkkS • Včetně přepínací nástrčné ráčny 6402-1 ■ 10 = 3/8" • Délka s/bez nástrčného nářadí: 347 mm / 302 mm 									
7290-2 sTAC CAL	□ 9x12, ■ 10 = 3/8"	302	1	3,5–44	5–60	1,8–22,2	✓	220373	2155,-
<ul style="list-style-type: none"> • Momentový klíč včetně kalibračního listu DAkkS • Včetně přepínací nástrčné ráčny 6402-1 ■ 10 = 3/8" • Délka s/bez nástrčného nářadí: 428 mm / 383 mm 									
7291-2 sTAC CAL	□ 9x12, ■ 10 = 3/8"	383	1	7,5–75	10–100	2,9–28,7	✓	220380	2215,-
<ul style="list-style-type: none"> • Momentový klíč včetně kalibračního listu DAkkS • Včetně přepínací nástrčné ráčny 6404-1 ■ 12,5 = 1/2" • Délka s/bez nástrčného nářadí: 578,5 mm / 520 mm 									
7292-2 sTAC CAL	□ 14x18, ■ 12,5 = 1/2"	520	1	15–150	20–200	4,1–40,7	✓	220397	2269,-
<ul style="list-style-type: none"> • Momentový klíč včetně kalibračního listu DAkkS • Včetně přepínací nástrčné ráčny 6406 ■ 20 = 3/4" • Délka s/bez nástrčného nářadí: 1021 mm / 945 mm 									
7294-2 sTAC CAL	□ 14x18, ■ 20 = 3/4"	945	1	30–300	40–400	4,4–43,8	✓	220403	2692,-
<ul style="list-style-type: none"> • Včetně přepínací nástrčné ráčny 6406 ■ 20 = 3/4" • Délka s/bez nástrčného nářadí: 1217 mm / 1141 mm 									
7295-2 sTAC CAL	□ 14x18, ■ 20 = 3/4"	1141	1	48–480	65–650	5,9–58,7	✓	220410	2758,-
<ul style="list-style-type: none"> • Momentový klíč včetně kalibračního listu DAkkS • Integrovaná přepínací ráčna ■ 20 = 3/4" 									
7250-2 sTAC CAL	■ 20 = 3/4"	1772	1	150–750	200–1000	12,2–60,8	✓	220342	3053,-
<ul style="list-style-type: none"> • Nástroj SmartTAC · programovatelný a vyhodnocovací software SmartTAC pro momentové / úhlové klíče HAZET série 7000 sTAC, také ke stažení na „www.hazet.de“ • Cena pro 1 uživatele 									
7910-sTAC	-	-	-	-	-	-	-	221875	154,20



Momentový šroubovák

6001 Momentový šroubovák · 6001 · 0,4–5,4 Nm

Made in Germany

• Pro všechna šroubení s nízkým utahovacím momentem, např. kotoučové brzdy na jízdním kole



- Zřetelné citelné a slyšitelné vypnutí utahovacího momentu při dosažení nastaveného utahovacího momentu na ráčně
- Možnost uvolnění bez funkce utahovacího momentu
- Rychlé a přesné nastavení hodnot utahovacího momentu pomocí zahnutého šroubováku (HAZET 2100-06, je součástí dodávky)
- Nástrčný držák bitů s magnetem pro všechny bity s nástrčným otvorem nebo adaptérem HAZET 2304 pro spojení s nástrčnými hlavicemi HAZET 850
- Přesnost (tolerance) na základě EN ISO 6789

Obsah:
momentová rukojeť s nástrčným držákem bitů
2239-7, zahnutý šroubovák 2100-06

- Plastová rukojeť



HAZET No.	Výstup	l mm	Přesnost vypnutí %	Nm		EAN-No. 4000896+	€
• Pro všechna šroubení s nízkým utahovacím momentem, např. ventilky u snímačů tlaku v pneumatikách							
• Pro utahovací momenty od 0,4 – 1,4 Nm							
6001-1.4/3	⊙ 6,3 = 1/4"	–	10	0,4–1,4	3	190980	75,30
• Pro utahovací momenty od 0,6 do 1,5 Nm							
6001-1.5/3	⊙ 6,3 = 1/4"	–	10	0,6–1,5	3	141678	70,85
• Podle servisních informací VW např. pro upevňovací šrouby tělesa vzduchového filtru na motoru 1,4 l s turbodmychadlem u VW Eos, Golf, Golf Plus a Passat							
6001-3.0/3	⊙ 6,3 = 1/4"	–	6	1,5–3	3	141685	70,85
6001-5.4/3	⊙ 6,3 = 1/4"	–	6	3–5,4	3	141692	70,85
• Adaptér ■ 6,3 = 1/4" – ● 6,3 = 1/4"							
2304	–	25	–	–	–	016020	17,50

6000 CT Momentový šroubovák · SYSTEM 6000 CT · ±5 % přesnost vypnutí · 0,1–6 Nm

- Přesnost ± 5 % z hodnoty stupnice (ve směru utahování)
- Pro bity s 6,3 = 1/4" pohon s vnějším šestihranem
- Ovládání nástrčných hlavic (□ nástrčný otvor 6,3 = 1/4") pomocí adaptéru HAZET 2304
- Plastová rukojeť
- DIN EN ISO 6789



HAZET No.	Výstup	l mm	Přesnost vypnutí %	Nm	cNm		EAN-No. 4000896+	€
6002 CT	⊙ 6,3 = 1/4"	170	5	0,1–1,2	10–120	0,01	023004	393,10
6003 CT	⊙ 6,3 = 1/4"	230	5	1–6	100–600	0,1	023011	409,70
• Adaptér ■ 6,3 = 1/4" – ● 6,3 = 1/4"								
2304	–	25	–	–	–	–	016020	17,50



Momentová technika

SYSTÉM 6300 CT



SYSTÉM 6300 CT

- **S pevně nastavitelnou hodnotou**
 - Obzvláště vhodné pro použití v průmyslové sériové výrobě
- Nastavení požadované hodnoty utahovacího momentu pomocí kombinovaného klíče 6399 ve spojení se zkoušečkou HAZET 7901 E, 7902 E, 7903 E nebo jiným vhodným přístrojem.
- Všechny klíče této konstrukční řady (HAZET 6391–6392) jsou provedeny bez stupnice pro nastavení a signalizačního tlačítka**

6300 Momentový klíč · ±2% přesnost · 6391-10 6% · 1–12 Nm

Made in Germany

- Zvláště šikový díky krátkému provedení
- Univerzálně použitelný díky uchycení pro zásuvné nářadí
- Přesnost ±2 % (6391-10: 6 %) z nastavené hodnoty (ve směru utahování)
- Utahování doleva je možné se stejnou přesností otočením klíče
- Zástrčka pro uchycení nástrčného nářadí
- **Napevno nastavitelná hodnota**
- Obzvláště vhodné pro použití v průmyslové sériové výrobě
- Nastavení požadované hodnoty utahovacího momentu pomocí kombinovaného klíče 6399 ve spojení se zkušebním přístrojem HAZET 7901 E, 7902 E, 7903 E nebo jiným vhodným přístrojem.
- **Všechny klíče této konstrukční řady (HAZET 6391-6392) jsou bez stupnice nastavení a signalizačního tlačítka**
- S osvědčením o kalibraci a sériovým číslem
- DIN EN ISO 6789-2:2017

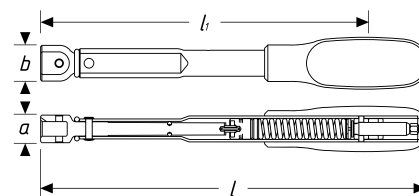

HAZET No.	Výstup	l mm	l _t mm	a mm	b mm	Přesnost vypnutí %	Nm		EAN-No. 4000896+	€
6391-10	□ 9x12	124	102	17	22	6	1–10	0,8–8,4	208951	171,50
6391-12	□ 9x12	124	102	17	22	2	2–12	1,7–10,1	027026	171,50
• Ze závodu podle Vašich přání předem nastavená spouštěcí hodnota										
6391-12 V	□ 9x12	124	102	17	22	2	2–12	1,7–10,1	145850	171,50

6300 Momentový klíč · ±2 % přesnost · 2–35 Nm

Made in Germany

- Přesnost ±2 % z nastavené hodnoty (ve směru utahování)
- Utahování doleva je možné se stejnou přesností otočením klíče
- Zástrčka pro uchycení nástrčného nářadí
- **Napevno nastavitelná hodnota**
- Obzvláště vhodné pro použití v průmyslové sériové výrobě
- Nastavení požadované hodnoty utahovacího momentu pomocí kombinovaného klíče 6399 ve spojení se zkušebním přístrojem HAZET 7901 E, 7902 E, 7903 E nebo jiným vhodným přístrojem
- **Všechny klíče této konstrukční řady (HAZET 6391-6392) jsou bez stupnice nastavení a signalizačního tlačítka**
- S osvědčením o kalibraci a sériovým číslem
- DIN EN ISO 6789-2:2017

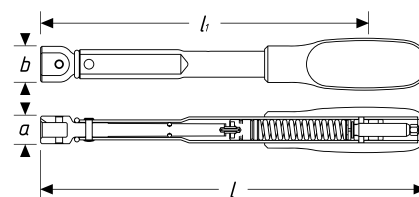

HAZET No.	Výstup	l mm	l _t mm	a mm	b mm	Přesnost vypnutí %	Nm		EAN-No. 4000896+	€
6391-25	□ 9x12	183	143	17	22	2	2–25	1,2–14,7	027040	138,30
6391-35	□ 9x12	183	143	17	22	2	15–35	8,8–20,6	027057	141,90
• Ze závodu podle Vašich přání předem nastavená spouštěcí hodnota										
6391-25 V	□ 9x12	183	143	17	22	2	2–25	1,2–14,7	145867	138,30
6391-35 V	□ 9x12	183	143	17	22	2	15–35	8,8–20,6	145874	141,90



6300 Momentový klíč · ±2 % přesnost · 5–85 Nm

Made in Germany

- **Přesnost ±2 % z nastavené hodnoty** (ve směru utahování)
Utahování doleva je možné se stejnou přesností otočením klíče
- Zástrčka pro uchycení nástrčného nářadí
- **Napevno nastavitelná hodnota**
- Obzvláště vhodné pro použití v průmyslové sériové výrobě
- Nastavení požadované hodnoty utahovacího momentu pomocí kombinovaného klíče 6399 ve spojení se zkušebním přístrojem HAZET 7901 E, 7902 E, 7903 E nebo jiným vhodným přístrojem
- **Všechny klíče této konstrukční řady (HAZET 6391-6392) jsou bez stupnice nastavení a signalizačního tlačítka**
- S osvědčením o kalibraci a sériovým číslem
- DIN EN ISO 6789-2:2017

E 9 x 12



HAZET No.	Výstup	l mm	l _t mm	a mm	b mm	Přesnost vypnutí %	Nm		EAN-No. 4000896+	€
6391-50	□ 9x12	241	201	17	22	2	5–50	2,2–22,1	027064	132,-
6391-85	□ 9x12	316	276	17	22	2	15–85	5,0–28,3	027071	135,70
• Ze závodu podle Vašich přání předem nastavená spouštěcí hodnota										
6391-50 V	□ 9x12	241	201	17	22	2	5–50	2,2–22,1	145881	132,-
6391-85 V	□ 9x12	316	276	17	22	2	15–85	5,0–28,3	145898	135,70

6300 Momentový klíč · ±2 % přesnost · 50–320 Nm

Made in Germany

- **Přesnost ±2 % z nastavené hodnoty** (ve směru utahování)
Utahování doleva je možné se stejnou přesností otočením klíče
- Zástrčka pro uchycení nástrčného nářadí
- **Napevno nastavitelná hodnota**
- Obzvláště vhodné pro použití v průmyslové sériové výrobě
- Nastavení požadované hodnoty utahovacího momentu pomocí kombinovaného klíče 6399 ve spojení se zkušebním přístrojem HAZET 7901 E, 7902 E, 7903 E nebo jiným vhodným přístrojem
- **Všechny klíče této konstrukční řady (HAZET 6391-6392) jsou bez stupnice nastavení a signalizačního tlačítka**
- S osvědčením o kalibraci a sériovým číslem
- DIN EN ISO 6789-2:2017

E 14 x 18

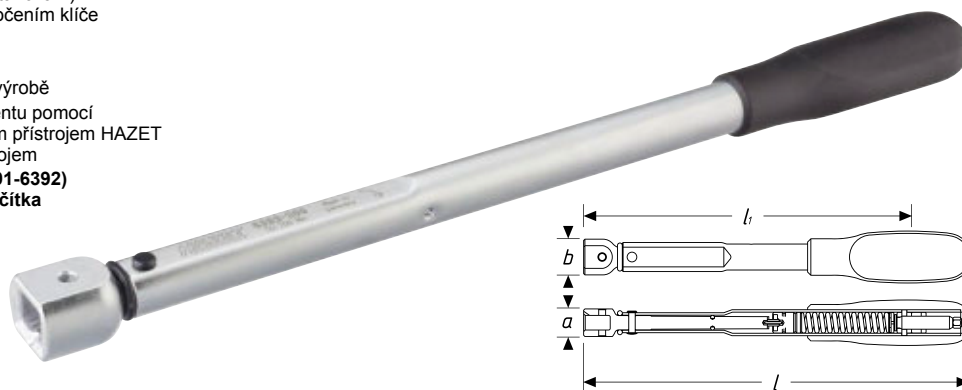

HAZET No.	Výstup	l mm	l _t mm	a mm	b mm	Přesnost vypnutí %	Nm		EAN-No. 4000896+	€
6392-200	□ 14x18	401	359	23	30	2	50–200	12,8–51,4	027118	155,80
6392-320	□ 14x18	631	589	23	30	2	60–320	9,8–52,0	027125	163,80
• Ze závodu podle Vašich přání předem nastavená spouštěcí hodnota										
6392-200 V	□ 14x18	401	359	23	30	2	50–200	12,8–51,4	145904	155,80
6392-320 V	□ 14x18	631	589	23	30	2	60–320	9,8–52,0	145911	163,80

6399 Kombinovaný klíč

Made in Germany

- Pro momentové klíče HAZET 6391 až 6392 (V)



HAZET No.	l mm	EAN-No. 4000896+	€
6399	167	027170	52,65



Nástrčné nářadí

6396 Držák nářadí

Made in Germany

• Z plného materiálu

• **Zástrčka**

pro uchycení nástrčného nářadí

• **Bez funkce utahovacího momentu**



HAZET No.	Výstup	l mm	EAN-No. 4000896+	€
6396	□ 9x12	405	027132	54,80
6397	□ 14x18	635	027149	71,85

6602 Nástrčná přepínací ráčna

Made in Germany

• 40 zubů

• maximálně 200 Nm (6602-1)

• maximálně 320 Nm (6604-1)

• Povrch: chromováno

• DIN 3120, ISO 1174-1

14 x 18

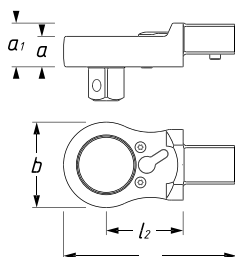

HAZET No.	Pohon	Výstup	l mm	l ₂ mm	a mm	a ₁ mm	b mm	EAN-No. 4000896+	€
6602-1	■ 14x18	■ 10 = 3/8"	81	36	14,3	20,5	40	179695	100,50
6604-1	■ 14x18	■ 12,5 = 1/2"	81	36	14,3	20,5	40	179701	107,50

6401-1 Nástrčná přepínací ráčna

Made in Germany

• 6401-1 20 zubů – maximálně 40 Nm
6402-1 30 zubů – maximálně 120 Nm
6403-1 32 zubů – maximálně 120 Nm
6404-1 32 zubů – maximálně 300 Nm

• Kováno v zápustce

• Povrch: chromováno

• DIN 3120, ISO 1174-1

E

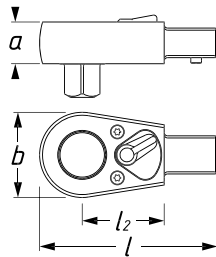
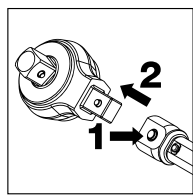

HAZET No.	Pohon	Výstup	l mm	l ₂ mm	a mm	b mm	EAN-No. 4000896+	€
6401-1	■ 9x12	■ 6,3 = 1/4"	46,5	19,5	9,9	21,8	027439	78,80
6402-1	■ 9x12	■ 10 = 3/8"	61	30	15	30	027460	99,35
6403-1	■ 9x12	■ 12,5 = 1/2"	74,5	38,5	19,6	40	027521	103,-
6404-1	■ 14x18	■ 12,5 = 1/2"	83,5	38,5	19,6	40	027552	106,30

6401 Nástrčná přepínací ráčna

Made in Germany

• Jemné ozubení, **72 zubů**, úhel otáčení 5°

• Kováno v zápustce

• Povrch: chromováno

• DIN 3120, ISO 1174-1

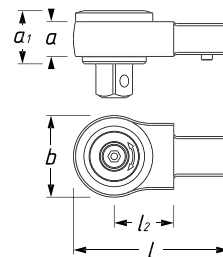
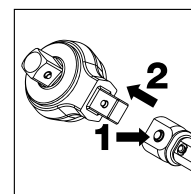

HAZET No.	Pohon	Výstup	l mm	l ₂ mm	a mm	a ₁ mm	b mm	EAN-No. 4000896+	€
6401 N	■ 9x12	■ 6,3 = 1/4"	46	17,5	11	16,5	25	115204	83,30
6402	■ 9x12	■ 10 = 3/8"	58,5	26	14,5	22,7	34,5	027453	77,60
6403	■ 9x12	■ 12,5 = 1/2"	58,5	26	14,5	22,5	34,5	027514	82,55
6404	■ 14x18	■ 12,5 = 1/2"	70,5	27	15,7	24,1	37	027545	86,65
6406	■ 14x18	■ 20 = 3/4"	101	44	24	35,6	64	027576	135,70

6401 S Nástrčná přepínací ráčna

Made in Germany

• **Rychlounvolňovací bezpečné spojení**

• 6401-1 S 20 zubů

• 6402-1 S 30 zubů

• 6403-1 S 32 zubů

• 6404-1 S 32 zubů

• Kováno v zápustce

• Povrch: chromováno

• DIN 3120, ISO 1174-1

E

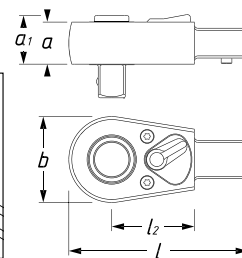
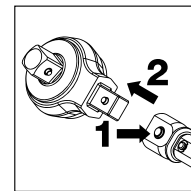

HAZET No.	Pohon	Výstup	l mm	l ₂ mm	a mm	a ₁ mm	b mm	EAN-No. 4000896+	€
6401-1 S	■ 9x12	■ 6,3 = 1/4"	46,5	19,5	9,9	12,2	21,8	027446	91,05
6402-1 S	■ 9x12	■ 10 = 3/8"	61	30	15	17,2	30	027477	111,90
6403-1 S	■ 9x12	■ 12,5 = 1/2"	74,5	38,5	19,6	22,7	40	027538	121,-
6404-1 S	■ 14x18	■ 12,5 = 1/2"	83,5	38,5	19,6	22,7	40	027569	126,10



6408 Přepínací ráčna na nástrčné bity

Made in Germany

- Uchycení bitů
- Kováno v zápustce
- Povrch: chromováno

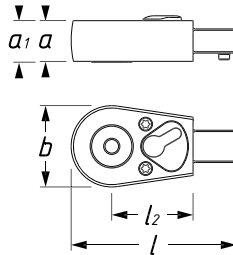
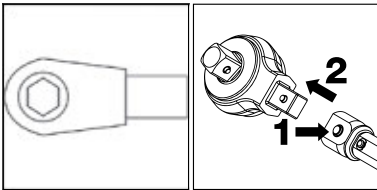

HAZET No.	Pohon	Výstup	l mm	l ₂ mm	a mm	a ₁ mm	b mm	EAN-No. 4000896+	€
6408	■ 9x12 ○ 6,3 = 1/4"	○	46,5	19,5	9,9	11,7	21,8	027583	72,45
• ○ Pohon 8 = 5/16" • 30 zubů									
6408-1	■ 9x12 ○ 8 = 5/8"	○	46,5	30	15	15,3	30	027590	89,20

Opotřebení? – Žádný problém!

- Nářadí HAZET je vyrobeno v nejvyšší kvalitě. Při dlouhém, intenzivním namáhání dochází i u vysoce kvalitních nástrojů k určitému opotřebení.
- Proto nabízíme pro mnoho našich nástrojů náhradní díly a sady náhradních dílů.

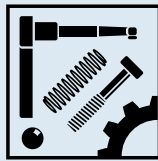

Nezapomeňte na náš obchod s náhradními díly
www.hazet.de/ersatzteil-shop

Úspora nákladů – udržitelnost – šetří zdroje!
 Abyste se mohli ze svého nářadí HAZET dlouho těšit

8816 Sada náhradních dílů

Made in Germany

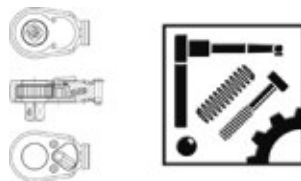

HAZET No.	Pohon	Výstup	l mm	l ₂ mm	a mm	b mm	EAN-No. 4000896+	€
• Sada náhradních dílů ovládací páky obsah sady: ovládací páka · šrouby · kulička · tlačná pružina · fixační prvek Pro přepínací ráčnu HAZET 8816 G · 8816 GK · 8816 P · 8816 S · 8816 ST 916 K · 2264-1 Pro momentový klíč HAZET 5110-2 CT · 5120-2 CT · 5110-3 CT · 5111-3 CT · 5120-3 CT 6110 CT · 6110-1 CT · 6111-1 CT 6114-1 CT · 6115-1 CT 6402-1 · 6402-1 S · 6408-1								
8816 P/6							144617	8,15
• Sada náhradních dílů kolečka ráčny 10 = 3/8" ■ obsah sady: kolečko ráčny · fixační prvek · ovládací páka · šrouby · kulička · tlačná pružina Pro přepínací ráčnu HAZET 8816 G · 8816 GK · 8816 P · 8816 ST Pro momentové klíče HAZET 5110-2 CT · 5110-3 CT · 5111-3 CT 6110 CT · 6110-1 CT · 6111-1 CT 6114-1 CT · 6115-1 CT · 6402-1								
8816 P/7 N							042234	20,85

8816 Sada náhradních dílů

HAZET No.	Pohon	Výstup	l mm	l ₂ mm	a mm	b mm	EAN-No. 4000896+	€
• Sada náhradních dílů ovládací páky obsah sady: ovládací páka · šrouby · kulička · tlačná pružina Pro momentové klíče HAZET 5107-2 CT · 5107-3 CT · 5108-2 CT · 5108-3 CT 6106-1 CT · 6108-1 CT · 6109-1 CT · 6109-2 CT · 6401-1 · 6401-1 S · 6408								
6401-1/6							146048	12,85
• Sada náhradních dílů kolečka ráčny 6,3 = 1/4" ■ obsah sady: kolečko ráčny · fixační prvek · ovládací páka · šrouby · kulička · tlačná pružina Pro momentové klíče HAZET 5107-2 CT · 5107-3 CT · 5108-2 CT · 5108-3 CT 6108-1 CT · 6109-1 CT · 6109-2 CT · 6401-1								
6401/7							111169	17,90
• Sada náhradních dílů kolečka ráčny 6,3 = 1/4" ■ obsah sady: kolečko ráčny se spouštěcím tlačítkem · fixační prvek · ovládací páka · šrouby · kulička · tlačná pružina Pro 6401-1 S a k přestavení nástrčných přepínacích ráčen 5107-2 CT · 5107-3 CT · 5108-2 CT · 5108-3 CT 6106-1 CT · 6108-1 CT · 6109-2 CT								
6401-1 S/7							111152	25,10
• Sada náhradní ovládací páky obsah sady: ovládací páka · 2 šrouby · kulička · tlačná pružina · pružná podložka a pojistný kroužek Pro nástrčnou přepínací ráčnu HAZET 6403-1 · 6403-1 S · 6404-1 · 6404-1 S								
6403-1/7							070756	13,55
• Sada náhradních dílů kolečka ráčny 12,5 = 1/2" ■ obsah sady: kolečko ráčny · fixační prvek · ovládací páka · šrouby · kulička · tlačná pružina · pružná podložka · pojistný kroužek Pro 6403-1 · 6404-1								
6403-1/9							070749	32,40
• Sada náhradních dílů kolečka ráčny 12,5 = 1/2" ■ obsah sady: kolečko ráčny se spouštěcím tlačítkem · fixační prvek · ovládací páka · šrouby · kulička · tlačná pružina · pružná podložka · pojistný kroužek Pro 6403-1 S · 6404-1 S								
6403-1 S/9							070817	51,50
• Sada náhradních dílů kolečka ráčny 10 = 3/8" ■ obsah sady: kolečko ráčny se spouštěcím tlačítkem · fixační prvek · ovládací páka · šrouby · kulička · tlačná pružina Pro přepínací ráčnu HAZET 8816 S · 8816 G · 8816 GK · 8816 ST · 6110 CT · 6110-1 CT · 6111-1 CT · 6114-1 CT · 6115-1 CT · 6402-1								
8816 S/7							048465	30,90

6413 Nástrčný držák a čtyřhran pro pohon

Made in Germany

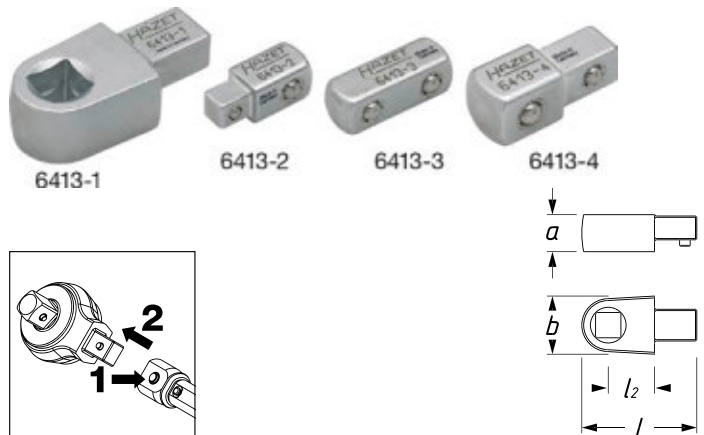

HAZET No.	Pohon	Výstup	l mm	l ₂ mm	a mm	b mm	EAN-No. 4000896+	€
• Držák nástrčného čtyřhranu 9x12 • □ Pohon 10 = 3/8"								
6413-1	■ 9x12 □ 10 = 3/8"		43,5	17,5	14	22	027644	31,80
• Prostrčný čtyřhran								
6413-2	■ 10 = 3/8" ■ 6,3 = 1/4"		22	-	-	-	048908	8,10
6413-3	■ 10 = 3/8" ■ 10 = 3/8"		25	-	-	-	048892	6,85
6413-4	■ 10 = 3/8" ■ 12,5 = 1/2"		30,2	-	-	-	048885	9,20



Momentová technika

Nástrčné nářadí



6414 Pohon nástrčným čtyřhranem

Made in Germany

- Povrch: chromováno
- DIN 3120, ISO 1174-1

14 x 18

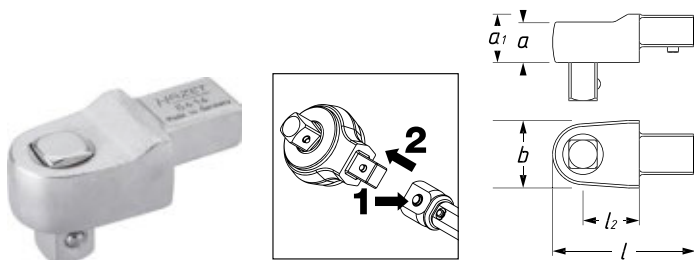

HAZET No.	Pohon	Výstup	l mm	l2 mm	a mm	a1 mm	b mm	EAN-No. 4000896+	€
6414	■ 14x18	■ 12,5 = 1/2"	63,5	25	18	21,5	30	027668	36,15

6420 Nástrčný držák bitů

Made in Germany

- Povrch: chromováno
- ISO 1173

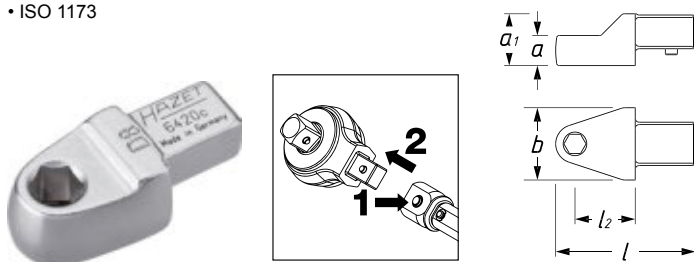

HAZET No.	Pohon	Výstup	l mm	l2 mm	a mm	a1 mm	b mm	EAN-No. 4000896+	€
6420 b	■ 9x12	○ 6,3 = 1/4"	40,5	17,5	10	14,5	20	027903	39,25
6420 c	■ 9x12	○ 8 = 5/16"	41,5	17,5	12,5	14,5	20	027910	37,95
6420 d	■ 14x18	○ 8 = 5/16"	58	25	12,5	21,5	30	027927	79,50

6423 Nástrčný adaptér

Made in Germany

- Povrch: chromováno

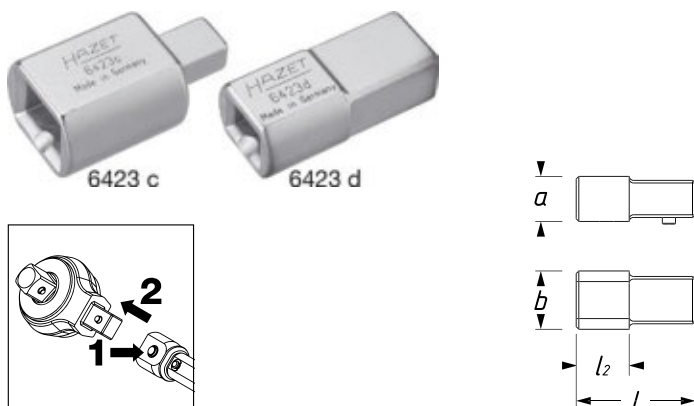

HAZET No.	Pohon	Výstup	l mm	l2 mm	a mm	b mm	EAN-No. 4000896+	€
• Uchycení s čtyřhranem 14 x 18 na 9 x 12								
6423 c	■ 9x12	□ 14x18	50	34	22,9	30	027934	57,10
• Uchycení s čtyřhranem 9 x 12 na 14 x 18								
6423 d	■ 14x18	□ 9x12	45	20	17	22	057559	53,85

6430 Nástrčný navařený díl

Made in Germany

- Dodání včetně pružiny, kolíku a kryty

Pozor: Při navařování nářadí se mohou změnit hodnoty vypínání. Respektujte pracovní délky (viz tabulka přepočtu na straně 271)

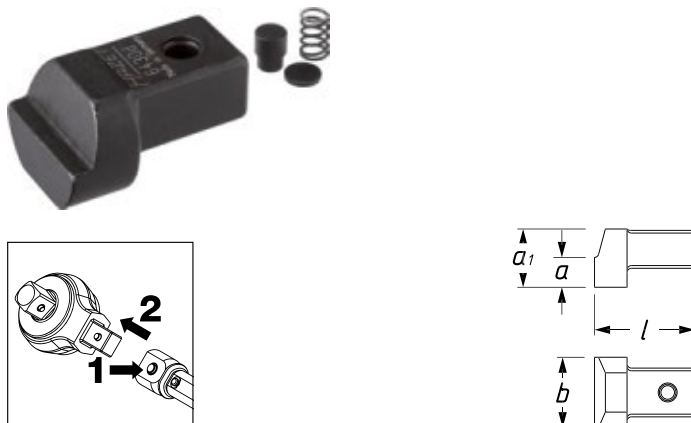

HAZET No.	Pohon	l mm	a mm	a1 mm	b mm	EAN-No. 4000896+	€
6430 c	■ 9x12	25	10	14,5	19	027958	29,65
6430 d	■ 14x18	38	11	21,5	26	027965	35,30

6450 C Nástrčný plochý klíč

Made in Germany

- Povrch: chromováno

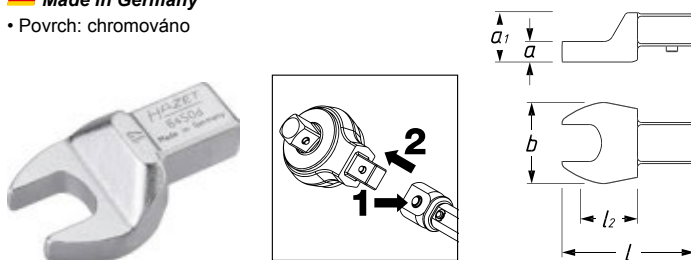

HAZET No.	S mm	Pohon	Výstup	l mm	l2 mm	a mm	a1 mm	b mm	EAN-No. 4000896+	€
6450 c- 7	7	■ 9x12	●	36,5	17,5	5,5	14,5	20	028429	35,65
6450 c- 8	8	■ 9x12	●	37	17,5	5,5	14,5	21,5	028436	35,65
6450 c- 9	9	■ 9x12	●	37,5	17,5	5,5	14,5	23	028443	35,65
6450 c-10	10	■ 9x12	●	38	17,5	5,5	14,5	24,5	028320	35,95
6450 c-11	11	■ 9x12	●	38,5	17,5	5,5	14,5	26	028337	35,65
6450 c-12	12	■ 9x12	●	38,5	17,5	5,5	14,5	27,5	028344	35,65
6450 c-13	13	■ 9x12	●	39	17,5	5,5	14,5	29	028351	35,65
6450 c-14	14	■ 9x12	●	42	20	7,5	14,5	31	028368	35,65
6450 c-15	15	■ 9x12	●	42,5	20	7,5	14,5	33	028375	35,65
6450 c-16	16	■ 9x12	●	43	20	7,5	14,5	35	028382	35,65
6450 c-17	17	■ 9x12	●	43,5	20	7,5	14,5	37	028399	35,65
6450 c-18	18	■ 9x12	●	44	20	7,5	14,5	39	028405	35,65
6450 c-19	19	■ 9x12	●	45	20	7,5	14,5	41	028412	35,65

6450 d-13	13	■ 14x18	●	56,5	25	7	21,5	30	028450	40,85
6450 d-14	14	■ 14x18	●	57	25	7	21,5	32	028467	40,85
6450 d-15	15	■ 14x18	●	57,5	25	7	21,5	34	028474	40,85
6450 d-16	16	■ 14x18	●	58	25	9	21,5	35,5	028481	40,85
6450 d-17	17	■ 14x18	●	58,5	25	9	21,5	37	028498	40,85
6450 d-18	18	■ 14x18	●	59	25	9	21,5	39	028504	40,85
6450 d-19	19	■ 14x18	●	59,5	25	9	21,5	41	028511	40,85
6450 d-21	21	■ 14x18	●	60,5	25	11	21,5	45	028528	48,85
6450 d-22	22	■ 14x18	●	61	25	11	21,5	47	028535	48,85
6450 d-24	24	■ 14x18	●	62	25	11	21,5	51	028542	48,85
6450 d-27	27	■ 14x18	●	68,5	32,5	13	22,5	58,5	028559	48,85
6450 d-30	30	■ 14x18	●	70	32,5	13	22,2	63	028566	54,95
6450 d-32	32	■ 14x18	●	71,5	32,5	13	22,2	65	028573	54,95
6450 d-34	34	■ 14x18	●	73,2	32,5	13	22,2	68,5	050178	54,95
6450 d-36	36	■ 14x18	●	70	32,5	13	22,2	67	072507	56,70
6450 d-38	38	■ 14x18	●	70	32,5	13	22,2	67	072514	56,70
6450 d-41	41	■ 14x18	●	79	40	12,4	22,5	82	028580	58,55



6606 D Nástrčný ráčnový očkový klíč

Made in Germany

• Přepínací funkce



- 40 zubů
- Max.: 320 Nm
- Kováno v záпустce
- Niže uložené přepínání chrání před nechtěným přepnutím
- Obzvláště pro momentový klíč HAZET 6291-1CT – 6293-1CT
- Mimořádně plochý, hluboce zalomený tvar pro práci ve stísněných pracovních podmínkách
- Povrch: chromováno

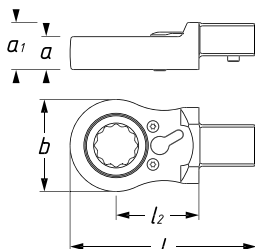

HAZET No.	S mm	Pohon	Výstup	l mm	l ₂ mm	a mm	a ₁ mm	b mm	EAN-No. 4000896+	€
6606 D-16	16	14x18	●	81	36	14,3	20,5	40	179923	92,25
6606 D-17	17	14x18	●	81	36	14,3	20,5	40	179886	92,25
6606 D-18	18	14x18	●	81	36	14,3	20,5	40	179893	93,50
6606 D-19	19	14x18	●	81	36	14,3	20,5	40	179909	95,40
6606 D-21	21	14x18	●	81	36	14,3	20,5	40	179916	96,70

6612 C Nástrčný očkový maticový klíč · otevřený

Made in Germany

• Povrch: chromováno

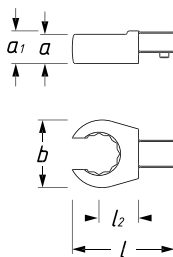
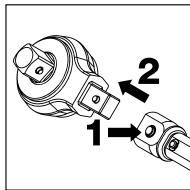

HAZET No.	S mm	Pohon	Výstup	l mm	l ₂ mm	a mm	a ₁ mm	b mm	EAN-No. 4000896+	€
6612 c-10	10	9x12	●	42,3	17,5	12	14,5	22	028726	39,65
6612 c-11	11	9x12	●	42,8	17,5	12	14,5	22,5	028733	39,65
6612 c-12	12	9x12	●	43,4	17,5	12	14,5	24	028740	39,65

6612 C Nástrčný očkový maticový klíč · otevřený

HAZET No.	S mm	Pohon	Výstup	l mm	l ₂ mm	a mm	a ₁ mm	b mm	EAN-No. 4000896+	€
6612 c-13	13	9x12	●	43,7	17,5	12	14,5	25	028757	39,65
6612 c-14	14	9x12	●	44,4	17,5	13	14,5	27	028764	39,65
6612 c-16	16	9x12	●	45,4	17,5	13	14,5	30	028771	39,65
6612 c-17	17	9x12	●	45,9	17,5	13	14,5	31,5	028788	39,65
6612 c-18	18	9x12	●	46,1	17,5	15	15	33	028795	39,65
6612 c-19	19	9x12	●	46,8	17,5	15	15	34,5	028801	39,65
6612 c-21	21	9x12	●	48	17,5	15	15	37,5	028818	39,65
6612 c-22	22	9x12	●	48,8	17,5	15	15	39	028825	39,65

6630 C Nástrčný očkový klíč

Made in Germany

• Povrch: chromováno

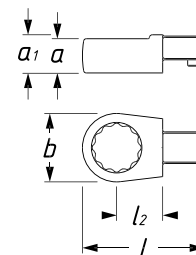
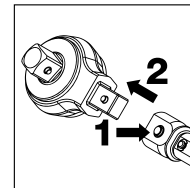

HAZET No.	S mm	Pohon	Výstup	l mm	l ₂ mm	a mm	a ₁ mm	b mm	EAN-No. 4000896+	€
6630 c- 7	7	9x12	●	40	17,5	8	14,5	20	028955	37,75
6630 c- 8	8	9x12	●	40,6	17,5	8	14,5	20	028962	37,75
6630 c-10	10	9x12	●	42,1	17,5	8	14,5	20	028832	37,75
6630 c-11	11	9x12	●	42,8	17,5	8	14,5	20	028849	37,75
6630 c-12	12	9x12	●	43,5	17,5	12	14,5	22	028856	37,75
6630 c-13	13	9x12	●	44,3	17,5	12	14,5	22	028863	37,75
6630 c-14	14	9x12	●	45	17,5	12	14,5	23	028870	37,75
6630 c-15	15	9x12	●	45,5	17,5	12	14,5	24	028887	37,75
6630 c-16	16	9x12	●	46,5	17,5	13	14,5	26	028894	37,75
6630 c-17	17	9x12	●	47	17,5	13	14,5	27	028900	37,75
6630 c-18	18	9x12	●	47,8	17,5	13	14,5	28,5	028917	37,75
6630 c-19	19	9x12	●	48,8	17,5	13	14,5	30,5	028924	37,75
6630 c-21	21	9x12	●	50	17,5	15	15	33	028931	37,75
6630 c-22	22	9x12	●	50,8	17,5	15	15	34,5	028948	37,75

6630 d-13	13	14x18	●	60,8	25	12	21,5	30	028979	41,60
6630 d-14	14	14x18	●	61,5	25	12	21,5	30	028986	41,60
6630 d-15	15	14x18	●	62	25	12	21,5	30	028993	41,60
6630 d-16	16	14x18	●	62,9	25	12	21,5	30	029006	41,60
6630 d-17	17	14x18	●	63,6	25	12	21,5	30	029013	41,60
6630 d-18	18	14x18	●	64,3	25	12	21,5	30	029020	41,60
6630 d-19	19	14x18	●	65,3	25	12	21,5	30,5	029037	41,60
6630 d-21	21	14x18	●	66,5	25	15	21,5	33	029044	49,80
6630 d-22	22	14x18	●	67,3	25	15	21,5	34,5	029051	49,80
6630 d-24	24	14x18	●	68,8	25	15	21,5	37,5	029068	49,80
6630 d-27	27	14x18	●	76,8	31	17,5	21,5	41,5	029075	49,80
6630 d-30	30	14x18	●	78,5	31	17,5	21,5	45	029082	55,95
6630 d-32	32	14x18	●	79,8	31	17,5	21,5	47,5	029099	55,95
6630 d-34	34	14x18	●	81,3	31	19	21,5	50,5	029105	55,95
6630 d-36	36	14x18	●	82,5	31	19	21,5	53	029112	55,95
6630 d-41	41	14x18	●	85,5	31	19	21,5	59	029129	55,95

Zkoušečky utahovacího momentu a příslušenství

6690 Úhelník, mechanický

Made in Germany

• Flexibilní, magnetický držák pro pevný bod

- K použití pro manipulační nářadí s pohonem 12,5 = 1/2" (resp. 20 = 3/4") a nástroje s pohonem 12,5 = 1/2" (resp. 20 = 3/4")
- Rozsah 0–360°, dělení 1°, Ø 95 mm



HAZET No.	Pohon	Výstup	EAN-No. 4000896+	€
6690	<input type="checkbox"/> 12,5 = 1/2"	<input checked="" type="checkbox"/> 12,5 = 1/2"	029266	140,10
6690-1	<input type="checkbox"/> 20 = 3/4"	<input checked="" type="checkbox"/> 20 = 3/4"	029273	187,60



Momentová technika

Zkoušečky utahovacího momentu a příslušenství



7900 E Zkoušečka utahovacího momentu · elektronická · 1–25 Nm

- Měřicí rozsah 1 až 25 Nm (maximální utahovací moment)
- Pevné šestihranné uchycení, ● ISO 1173 C-6,3 = 1/4" včetně adaptéru



- Přesnost ± 1 %
- 3 režimy použití:
 - pohyblivý číslíkový ukazatel (Track)
 - rozeznání zlomového bodu (First Peak)
 - zobrazení vrcholové hodnoty (Final Peak)
- Rozsah dodávky včetně nabíječky a RS-232C propojovacího kabelu k PC resp. tiskárně
- Kompatibilní se zkušebním softwarem 7901 E-D
- Velký, dobře čitelný LED displej s 3 LED pro snadší rozpoznání statusu zobrazení
- Rychlé upevnění pomocí 4 šroubů na rovné povrchy (stůl, stěna atd.)
- Snadná obsluha
- Zobrazení v Nm, bezproblémové přepnutí na lbf.ft a lbf.in
- Jednoduché zadání cílového utahovacího momentu s tolerancí
- Včetně certifikátu o zkoušce
- Hmotnost přístroje: 3,28 kg
- Hmotnost včetně kufru a nabíječky: 4,66 kg
- V 97,5xØ 160 mm



HAZET No.	Pohon	Nm	EAN-No. 4000896+	€
7903 E	● 6,3 = 1/4"	1–25	167425	1455,-

7900 E Zkoušečka utahovacího momentu · elektronická · 10–350 Nm

- Měřicí rozsah 10–350 Nm (maximální utahovací moment)
- Fixní čtyřhranné upínadlo, 12,5 = 1/2"

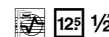

- Přesnost ± 1 %
- 3 režimy použití:
 - pohyblivý číslíkový ukazatel (Track)
 - rozeznání zlomového bodu (First Peak)
 - zobrazení vrcholové hodnoty (Final Peak)
- Rozsah dodávky včetně nabíječky a RS-232C propojovacího kabelu k PC resp. tiskárně
- Kompatibilní se zkušebním softwarem 7901 E-D
- Velký, dobře čitelný LED displej s 3 LED pro snadší rozpoznání statusu zobrazení
- Rychlé upevnění pomocí 4 šroubů na rovné povrchy (stůl, stěna atd.)
- Snadná obsluha
- Zobrazení v Nm, bezproblémové přepnutí na lbf.ft a lbf.in
- Jednoduché zadání cílového utahovacího momentu s tolerancí
- Včetně certifikátu o zkoušce
- Hmotnost přístroje: 3,28 kg
- Hmotnost včetně kufru a nabíječky: 4,66 kg
- V 97,5xØ 160 mm



HAZET No.	Pohon	Nm	EAN-No. 4000896+	€
7901 E	□ 12,5 = 1/2"	10–350	140671	1445,-

7900 E Zkoušečka utahovacího momentu · elektronická · 100–1000 Nm

- Měřicí rozsah 100 až 1000 Nm (maximální utahovací moment)
- Pevné uchycení s šestihranem, s 27°mm



- Přesnost ± 1 %
- 3 režimy použití:
 - pohyblivý číslíkový ukazatel (Track)
 - rozeznání zlomového bodu (First Peak)
 - zobrazení vrcholové hodnoty (Final Peak)
- Rozsah dodávky včetně nabíječky a RS-232C propojovacího kabelu k PC resp. tiskárně
- Kompatibilní se zkušebním softwarem 7901 E-D
- Velký, dobře čitelný LED displej s 3 LED pro snadší rozpoznání statusu zobrazení
- Rychlé upevnění pomocí 4 šroubů na rovné povrchy (stůl, stěna atd.)
- Snadná obsluha
- Zobrazení v Nm, bezproblémové přepnutí na lbf.ft a lbf.in
- Jednoduché zadání cílového utahovacího momentu s tolerancí
- Včetně certifikátu o zkoušce
- Hmotnost přístroje: 3,28 kg
- Hmotnost včetně kufru a nabíječky: 4,66 kg
- H 97,5xØ 160 mm (182 mm včetně zkušebního šestihranu)



HAZET No.	Pohon	Nm	EAN-No. 4000896+	€
7902 E	● 27 mm	100–1000	150229	1958,-



7900 E Kontrolní software Torque-Testing

Made in Germany

• Pro elektronické zkoušečky utahovacího momentu 7901 E, 7902 E a 7903 E

- Včetně databáze (možnost aktualizace) všech aktuálních momentových klíčů HAZET (jejich hodnoty zkoušek jsou v rozsahu od 1 – 1000 Nm) a zásuvných nářadí
- Možnost rozšířit databanku zadáním jiných výrobců, dalších vypinacích momentových klíčů (klikací typ), nástrčného nářadí, měřicího rozsahu, zkušebních hodnot, jednotek, tolerancí a norem
- Software s možností nastavení vlastního rozvržení certifikátu a možností vložení vlastního firemního loga
- S jazykovou podporou. Vedle nastavení německého a anglického jazyka umožňuje jazyková podpora uživateli nastavit uživatelské prostředí, tabulky a názvy polí v jakémkoliv jazyce
- Funkce internetové aktualizace
- Včetně rozsáhlé dokumentace

Předpoklad systému

Operační systém: Windows 7® / Windows 8® / Windows 10® (64 bit)

Paměť: minimálně 50 MB volné paměti na pevném disku

Operační paměť: minimálně 256 MB

Přípojky: 1. USB port pro software

2. přípojka pro zkušební přístroje

COM port (přípojovací kabel v rozsahu dodávky elektronického zkušební přístroje utahovacího momentu)

Grafické rozlišení: Minimálně 1024 x 768

Pozor:

Pokud by hardware neměl žádný COM port, lze zkušební přístroj připojit také s adaptérem USB na COM port (RS 232) (není v rozsahu dodávky)

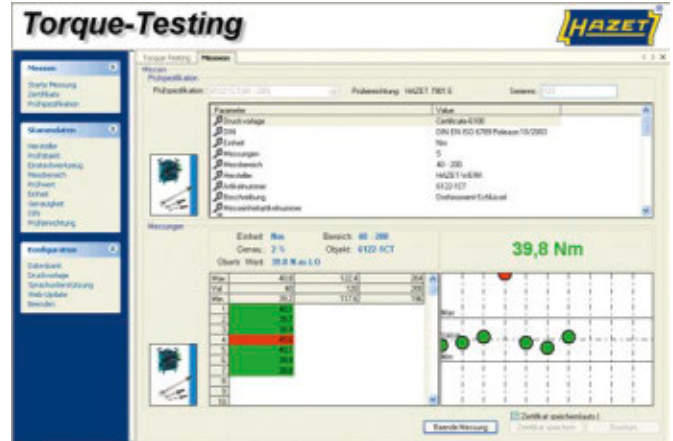

HAZET No.	EAN-No. 4000896+	€
7901 E-D	148202	926,-

7920 E Kalibrační zařízení pro utahovací moment 1–800 Nm

Made in Germany

• Modulární systém díky vysoce kvalitním, vyměnitelným snímačům utahovacího momentu

- Použití: Kalibrace signalizujících a spouštějících momentových klíčů dle DIN EN ISO 6789-1:2017 a -2:2017

Motoricky poháněné kalibrační zařízení pro utahovací moment s řízením integrovaným PC
Vysoce kvalitní snímače utahovacího momentu:

- Vyměnitelné snímače utahovacího momentu ve 2 třídách přesnosti určují oblast utahovacího momentu:
 - 0,25% – pro zobrazující a vypinací momentové klíče s přesností ± 1% (např. pro produktovou skupinu 7000 sTAC · 7000 eTAC)
 - 0,50% – pro zobrazující a vypinací momentové klíče s přesností ± 2% (např. pro produktovou skupinu 6000 CT)
- Systém rychlé výměny pro jmenovité velikosti hlavice **3/8 1/4 10 1/8 1/2 3/4 2 1**
- Automatické rozeznání snímače
- Vytahovací rameno až do cca 1,20 m včetně výškového nastavení
- Ovládací zařízení kalibrovatelné vpravo / vlevo
- Integrované PC (operační systém Windows 10)
Možnosti připojení pro obrazovku, klávesnici a myš (není obsaženo v rozsahu dodávky) a také dálkový přístup přes Remote Desktop
- Včetně softwaru
 - Řízení zkušebního stavu
 - Zaznamenávání měřených dat
 - Kalibrační doklad, prohlášení o shodě nebo kombinace obojího (jako HAZET) také s individualizovanými firemními údaji
 - Obsažena správa artiklů – HAZET Datenpool včetně všech parametrů ke sledování nejistoty měření
 - Správa nástrojů
 - Online aktualizace a údržba přes dálkové ovládání
- Rozměry délka: cca 1140 mm (vytaženo 1680 mm) šířka x výška cca 570 x 600 mm
- Napájení napětím: 200–250 V / PE-N / 50–60 Hz
- 3 výškově nastavitelné nohy k vodorovnému vyrovnání
- Cena na vyžádání, dodací lhůta dle dohody



7920 E-200-1 · -2
7920 E-800-1 · -2



Momentová technika

Zkoušečky utahovacího momentu a příslušenství



7920 E Kalibrační zařízení pro utahovací moment 1–800 Nm

* = cena na vyžádání

HAZET No.	EAN-No. 4000896+	€
• Kalibrační zařízení pro utahovací moment bez snímačů 7920 E	223756	*
• Snímač utahovacího momentu pro kalibrační zařízení 7920 E • 1–200 Nm · třída přesnosti 0,25 % 7920 E-200-1	219230	*
• Snímač utahovacího momentu pro kalibrační zařízení 7920 E • 1–200 Nm · třída přesnosti 0,50 % 7920 E-200-2	219247	*
• Snímač utahovacího momentu pro kalibrační zařízení 7920 E • 60–800 Nm · třída přesnosti 0,25 % 7920 E-800-1	219254	*
• Snímač utahovacího momentu pro kalibrační zařízení 7920 E • 60–800 Nm · třída přesnosti 0,50 % 7920 E-800-2	219223	*

SP-10-30 HAZET SERVIS pro momentové klíče a pneumatické nástroje

Made in Germany

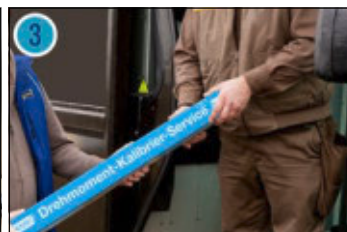

Všechny momentové a pneumatické nástroje HAZET jsou servisovatelné! Kromě oprav v servisním centru HAZET nabízíme pro momentové klíče kontroly v závodě až po kalibraci ve vlastní kalibrační laboratoři DAkkS. Ohledně všech výkonů servisního centra HAZET a nabídky servisu na místě Vám rád poradí váš lokální partner HAZET.







Rázový utahovák

311–316

Ráčnový šroubovák

316–320

Vrtačky a brusky (řezání a třískové obrábění)

320–334

Pistole na slepé nýty

334–335

Vyfukovací nářadí

335–337

Zařízení pro huštění a měření pneumatik

338

Tukové lisy, stříkácí pistole, sací/foukací pistole

339–340

Pneumatické spojovací díly

340–343

Pneumatické příslušenství

344

Box s pneumatickým údržbářským nářadím

345

Aku rázový utahovák, vrtačka, úhlová bruska

348–352

Horkovzdušné ruční přístroje

352–353



Legenda k piktogramům

	Výkonný kolíkový úderník
	Výkonný dvojkladivový úderník
	Jednokladivový úderník
	Přímý kladivový úderník
	TwinTurbo Technologie
	Mini nástroj
	Výstup
	Závít vzduchové přípojky
	Doporučený točivý moment
	Max. točivý moment
	Max. povolovací moment

	Max. otáčky/min.
	Brusný zdvih
	Max. otáčky/min. pravý/levý chod
	Hmotnost (netto) [bez vsuvky]
	Tlaková hadice
	Spotřeba vzduchu
	Provozní tlak
	Hladina akustického tlaku (LpA)
	Hladina akustického výkonu (LpW)
	Vibrační zrychlení
	Velikost šroubu

	Skříčidlo
	Brusný talíř Ø
	Zdvih pily
	Řezný výkon ocelový plech
	Řezný výkon hliník
	Rozsah měření manometru
	Dělení stupnice
	Teplotní rozsah
	Tepleně izolovaná rukojeť
	Počet dílů v sadě / sortiment

Všechny pneumatické stroje pracují s tlakem 6,3 baru.

HAZET SERVIS pro momentové klíče a pneumatické nástroje

Všechny momentové a pneumatické nástroje HAZET jsou servisovatelné! Kromě oprav v servisním centru HAZET nabízíme pro momentové klíče kontroly v závodě až po kalibraci ve vlastní kalibrační laboratoři DAkKS. Ohledně všech výkonů servisního centra HAZET a nabídky servisu na místě Vám rád poradí váš lokální partner HAZET.

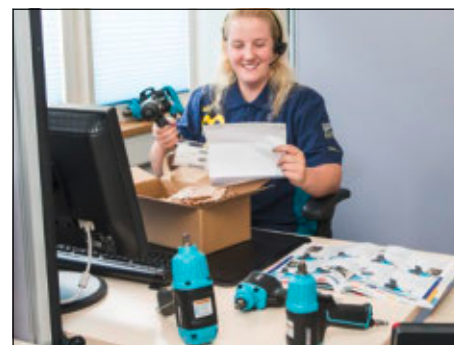

Servisní centrum HAZET

Přímý kontakt a pracoviště pro koordinaci služeb týkajících se našich produktů

+49(0)2191/792-355
 +49(0)2191/792-523
 service-center@hazet.de

- Nejlepší poprodejní servis s krátkými reakčními dobami a kompletní kompetencí společnosti HAZET získáte v našem speciálně zřízeném servisním centru.





Při použití pneumatických nástrojů existují různé parametry, které musí být respektovány, aby se dosáhlo nejlepšího možného výsledku.

Naše provozní návody obsahují technické informace, jako např. údaje o provozním tlaku, průměru hadice, atd.

Tyto údaje je nutně třeba respektovat, protože to může podstatně ovlivnit výkon pneumatického nástroje.

Provozní tlak

- Snížení doporučeného provozního tlaku o 1 bar, vede ke snížení výkonu až do 25%.
 - Příliš malý průměr hadice nebo příliš velká délka hadice snižuje průtočné množství vzduchu a tím výkonnost produktu.
- Vyšší provozní tlak než uvedený, podporuje vyšší opotřebení nástroje.

Kompresor

Pneumatický nástroj je provozován s tlakovým vzduchem (stlačený vzduch). K vytvoření tlakového vzduchu je třeba kompresor. Kompresor musí být zvolen tak, aby mohl kontinuálně vytvářet potřebné množství tlakového vzduchu.

K našemu pneumatickému nářadí uvádíme v provozních návodech, kolik vzduchu je třeba k dosažení potřebného výkonu. Naše rázové utahovačky potřebují podle modelu mezi 70 a 283 litry tlakového vzduchu za minutu při pracovním tlaku asi 6,3 bar.

- Často jsou údaje na kompresoru uvedené „bez tlaku“.
- To znamená, že pokud je na kompresoru uvedeno „150 litrů za minutu“, jde o množství tlakového vzduchu, které kompresor vyrobí **bez** tlaku v zásobníku.

Se zvyšováním potřebného provozního tlaku se výrazně snižuje vyrobené množství vzduchu. Pro výrobu a vytvoření zásoby 150 litrů tlakového vzduchu za minutu při pracovním tlaku 6,3 baru je zapotřebí velký dílenský kompresor. Běžný kompresor pro domácnost s 25 litrovou nádrží na tlakový vzduch vyrobí průměrně 200 litrů tlakového vzduchu za minutu. Motor přitom pracuje (obvykle cca 1,5 kW / 2 PS) minimálně proti tlaku 6,3 baru v nádrži na tlakový vzduch. Často tak zbývá efektivní potenciál jen jedné desetiny, tedy cca 15 litrů za minutu.

- Proto doporučujeme porovnat údaje mezi kompresorem a používaným nářadím.

Pneumatická hadice

- Pro plný výkon pneumatických přístrojů jsou spolurozhodující průměry a délky hadic.
- U hadice by **vnitřní průměr** neměl být menší než 10 mm, aby bylo zaručeno potřebné průtočné množství vzduchu. Čím kratší je hadice z kompresoru k zařízení, tím nižší je ztráta vzniklá třením a zařízení má k dispozici plný tlak vyrobený kompresorem.

Údržba a péče

- Čistý, suchý vzduch a také každodenní olejování jsou zárukou dlouhé životnosti pneumatických přístrojů
- Dlouhá životnost pneumatického nástroje příslušně závisí na údržbě.
- Respektujte údaje v provozním návodu ohledně uschování a údržby.





TwinTurbo Technology by HAZET

Nejsilnější série rázových utahováků HAZET všech dob Exkluzivně pouze u HAZET

- Maximální efektivita díky směrodatné „technologii HAZET TwinTurbo“ umožňuje vysoké točivé momenty při kompaktním způsobu konstrukce
- Inovativní 8 lamelový vzduchový motor s o 25 % vyšším výkonem úderu zaručuje maximální točivý moment
- Vysoká trvanlivost a vysoká efektivita při použití v průmyslu a automobilovém průmyslu
- Vyšším výkonem ovlivní rychlejší povolání šroubového spoje při šroubování a tím je dvakrát tak efektivní.
- Výhoda: Úspora času, protože pracovní postup je rychleji ukončen a tím se spotřebovalo méně vzduchu = úspora nákladů!

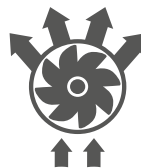

Standard

1x přívod vzduchu

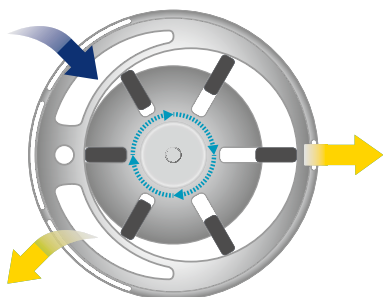

2x odvod vzduchu

TwinTurbo

2x přívod vzduchu

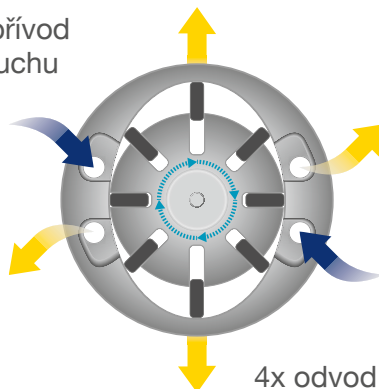

4x odvod vzduchu

Program Mini pneumatické nářadí

- Extrémně malé a příruční
- Vysoká spolehlivost a trvalý provoz
- Včetně bezpečnostní spouštěcí páky (kromě 9023 M-1)
- Inovativní 5 lamelová koncepce pro ještě větší výkon než pohony běžné na trhu



Standard:
4 lamely

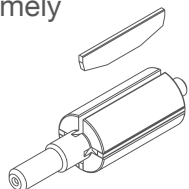

Mini nástroj:
5 lamel

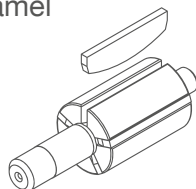



Přehled rázových šroubováků HAZET

		■	max. Nm	Nm	max. Nm	db (A) LpA	db (A) LpW	l/min.	kg	Úderníky	m/s ²
	9011 M	10 3/8"	461	375	461	90.3	101.3	85.2	1.24		7.78
	9012 M	12 5/8"	1100	610	678	97.1	108.1	127	1.242		9.57
	9012 M-1	12 5/8"	1200	610	678	92.2	103.2	127.4	1.27		13.49
	9012 MT	12 5/8"	1400	620	745	92.7	102	135	1.32		8.74
	9012 A TT	12 5/8"	550	450	500	90.1	101.1	113	1.3		4.89
	9012 SPC	12 5/8"	850	550	750	92.1	103.1	127.4	2.6		7.42
	9012 EL-SPC	12 5/8"	1700	881	1054	98	109	139	1.98		10.23
	9012 TT	12 5/8"	2200	948	1356	99.7	110.7	147.2	1.6		8.69
	9013 M	20 3/4"	1890	922	1085	104	93	153	2.1		7.47
	9013 Lg TT	20 3/4"	3800	1758	2020	102.5	113.5	243	5.5		9.017
	9013 TT	20 3/4"	4100	1890	2170	99.5	110.5	243.5	4.5		10.69
	9014 TT	25 1"	4100	1898	2170	101.9	112.9	235	4.6		19.11
	9014 PS-1	25 1"	3400	2400	2712	103.5	114.5	283	7.8		15.94
	9014 P-1	25 1"	3400	2400	2712	103.5	114.5	283	8.58		15.94



Přehled ráčnových šroubováků HAZET

			max. Nm	db (A) LpA	db (A) LpW	I/min.	kg	Úderníky	m/s ²
	9020-2	6.3 1/4"	35	83	89	180	0.5		3.3
	9020 P-2	6.3 1/4"	40	90	101	72	0.5		3.3
	9023 M-1	6.3 1/4" 10 3/8" 6.3 1/4"	54	82.8	93.8	84	0.48		3.2
	9021-3	10 3/8"	35	83	89	180	0.5		3.3
	9021 P-2	10 3/8"	54	92	103	103	0.5		3.9
	9021 SR-1	10 3/8"	68	82	93	68	0.67		9.84
	9022-2	12 ⁵ 1/2"	70	88	95	180	1.2		8.5
	9022 P-2	12 ⁵ 1/2"	108	99	110	113	1.24		9.1
	9022 P-1	12 ⁵ 1/2"	95	88.3	99.3	77	1.39		3
	9022-360	12 ⁵ 1/2"	120	91.2	102.2	107.6	1.55		4.87
	9022 SR-1	12 ⁵ 1/2"	102	91	98	113	1.28		4.53
	9022 P-X Lg	12 ⁵ 1/2"	94.8	93.7	104.7	99.12	2.1		5.6



Výkonný kolíkový úderník

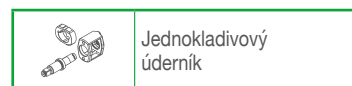

Jednokladivový úderník

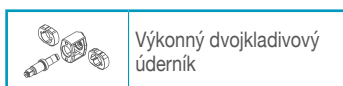

Výkonný dvojkladivový úderník

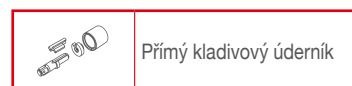

Přímý kladivový úderník



Přehled vrtaček a brusek HAZET

		db (A) LpA	db (A) LpW	l/min.	kg	m/s ²
	9030 N-1	88.7	99.7	113	1	2.1
	9030 N-5	85	96	113	1.2	0.5
	9030 P-1	88.4	99.4	113	1.3	1.2
	9032 M	80.4	86.4	75	0.23	0.8
	9032 M-36	78.7	85.8	43.7	0.38	1.8
	9032 N-1	79	85	74	0.4	0.4
	9032 N-5	78	82	74	0.5	0.5
	9032 P-1	87	98	150	0.8	0.46
	9032 Lg-1	81	78	99	0.6	0.5
	9032 M-1	82.4	93.4	84	0.33	1.8
	9032 M-5	81.9	92.9	84	0.48	5.1
	9033-2	88.8		57	0.9	
	9033 N-4	83.8	94.8	94	0.81	1.88
	9033 N-5	80	93	79	0.64	0.77
	9033 N-6	79	82	102	1.2	0.8



Přehled vrtaček a brusek HAZET

		db (A) LpA	db (A) LpW	l/min.	kg	m/s ²
	9033 N-9	85.76	96.76	91	0.72	2.43
	9033 N-7	85	96	113	2	6.5
	9033 P-8	89.5	100.5	113	1.7	3.65
	9033-10	88	88	114	0.9	1.8
	9033-11/17	75	86	79	0.54	3.11
	9033 M-7	85.8	96.8	84	0.53	1.9
	9033 M-9	83.6	94.4	84	0.6	1.9
	9033 M-11	84.2	95.2	84	0.44	1.8
	9034 P-2	86.7	97.7	99	0.4	6.13
	9035-5	97		170	2.6	
	9035 M-5	87.9	98.8	48.1	0.48	
	9035 H/6	92-105		57-594	2.5	
	9035 V/6	92-105		57-594	2.5	
	9036 N-1	80	87	104	1	1.9
	9036 N-5	80	86	104	1	1.6



Přehled pistolí na slepé nýty HAZET

		db (A) LpA	db (A) LpW	l/zdvih	kg	m/s ²
	9037 SPC	73		1	1.5	
	9037 N-2			2.64	2.11	

Přehled vyfukovacího nářadí HAZET

		db (A) LpA	db (A) LpW	l/min.	kg	m/s ²
	9040 P-1	84		290	0.105	
	9040 P-2	84		290	0.19	
	9040 P-3	76.8		245	0.1	
	9040 P-4	83.7		235	0.165	
	9040 P-5	78		450	0.095	
	9040-3					
	9040-4	86		330	0.205	
	9040 Lg-3/2			450	0.313	

Osvědčené baterie – akumulátory Li-Ion:

- Nemají paměťový efekt
- Sestávají z článků po 3,6 V
- Mají po úplném nabití vyšší napětí než 3,6 V, tzn. 5 článků po 3,6 V = 18 V – ale po úplném nabití je možné špičkové napětí do 20 V.
- Pozor: pro dlouhou životnost akumulátoru jej skladujte nabité jen na 50 až 80 %
- Mají více než dvojnásobnou hustotu energie než např. niklokadmiové akumulátory
- Disponují přibližně třikrát vyšším jmenovitým napětím než nikl-metalhydridové akumulátory
- Potřebují více kompletních nabíjecích cyklů, aby se dosáhlo plně kapacity



Přehled tukových lisů, stříkacích pistolí, sacích/foukacích pistolí HAZET

		db (A) LpA	db (A) LpW	l/min.	kg	m/s ²
	9042 N-1			230	2	
	9042 P-4					
	9043 N-10	92	97	96	0.403	0.4
	9045 P-1			280	0.46	

Přehled akumulátorových rázových šroubováků HAZET

			max. Nm	Nm	max. Nm	db (A) LpA	db (A) LpW	kg	m/s ²
	9212 SPC-1	1 1/2"	260	200	200	100	111	1.45	14.912
	9212 M-1	1 1/2"	270	220	220	99.6	110.6	1.34	15.4
	9212-3	1 1/2"	700	500	500	99.4	110.4	1.857	20.3
	9212-1000	1 1/2"	1400		1000	101	112	3.64	17.8
	9213-1000	3/4"	1400		1000	101	112	3.7	17.8

Přehled akumulátorových vrtaček / úhlových brusek HAZET

		max. Nm	1	2	db (A) LpA	db (A) LpW	kg	m/s ²
	9230-2	60	0-560	0-1900	68		1.68	79
	9233-7		8000		89		2.28	7.9



Pneumatické nářadí / stroje

Rázový utahovák



Rázový utahovák

9011 M Rázový utahovák · extra krátký

• Povolovací moment: 461 Nm

ⓔ 10 3/8

- Odvětrání přes rukojeť směrem dolů
- Nízké vibrace
- Jednoduché ovládání
- **Extra krátký – jen 92 mm**
- Jednokladivový úderník
- Vzduchová přípojka vstup: Vnitřní závit 12,91 mm (1/4")
- Spojovací konektor: jmenovitá velikost 7,2 (včetně)
- Doporučený utahovací moment: 375 Nm
- Průměr hadice (doporučeno): 10 mm
- Pracovní tlak [bar]: 6,3
- Hladina akustického výkonu (při provozním tlaku): 101,3 db(A) Lp W
- Vibrační zrychlení: 7,78 m/s²
- Povolovací moment (max.) zjištěný s velikostí šroubu M: 13
- Pravý/levý chod: třístupňový (otáčení doprava), jednostupňový (otáčení doleva)
- Rukojeť s izolací vůči chladu
- **Extrémně kompaktní konstrukce umožňuje práci i ve stísněných prostorech**
- Jednoruční ovládání pro praváky a leváky



9012 Rázový utahovák · extra krátký

• Povolovací moment: 1100 Nm

ⓔ 12 1/2

- Odvětrání přes rukojeť směrem dolů
- Nízké vibrace
- Jednoduché ovládání
- **Extra krátký – jen 92 mm**
- Jednokladivový úderník
- Vzduchová přípojka vstup: Vnitřní závit 12,91 mm (1/4")
- Spojovací konektor: jmenovitá velikost 7,2 (včetně)
- Doporučený utahovací moment: 610 Nm
- Průměr hadice (doporučeno): 10 mm
- Pracovní tlak [bar]: 6,3
- Hladina akustického výkonu (při provozním tlaku): 108,1 db(A) Lp W
- Vibrační zrychlení: 9,57 m/s²
- Povolovací moment (max.) zjištěný s velikostí šroubu M: 16
- Pravý/levý chod: třístupňový (otáčení doprava), jednostupňový (otáčení doleva)
- Rukojeť s izolací vůči chladu
- **Extrémně kompaktní konstrukce umožňuje práci i ve stísněných prostorech**
- Jednoruční ovládání pro praváky a leváky



YouTube Clip

360°

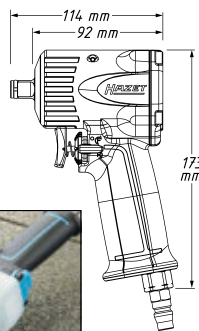

YouTube Clip

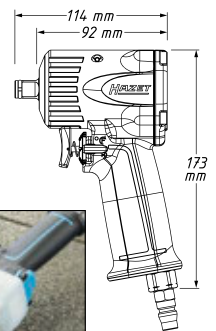
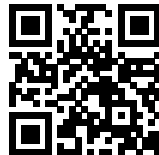

9012 M-S



9012 M-S

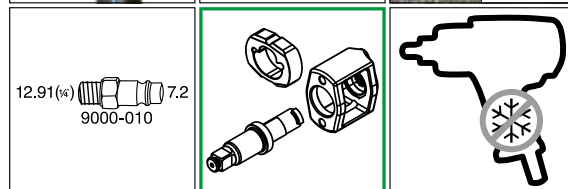
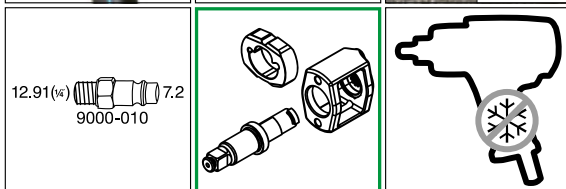

HAZET No.	max. Nm	max. Nm	l/min.	ot./min.	db (A) LpA	g	EAN-No. 4000896+	€
9011 M	461	461	85,2	6500	90,3	1240	201570	207,90
Silikonový ochranný obal pro 9011 M a 9012 M								
9012 M-S	-	-	-	-	-	-	202232	6,85

HAZET No.	max. Nm	max. Nm	l/min.	ot./min.	db (A) LpA	g	EAN-No. 4000896+	€
9012 M	1100	678	127	10000	97,1	1242	188987	220,60
Silikonový ochranný obal pro 9011 M a 9012 M								
9012 M-S	-	-	-	-	-	-	202232	6,85





9012 Rázový utahovák · extra krátký

• Povolovací moment: 1200 Nm

12½ 1/2

- Odvětrání přes rukojeť směrem dolů
- Nízké vibrace
- Jednoduché ovládání
- **Extra krátký – jen 80 mm**
- Jednokladikový úderník
- Vzduchová přípojka vstup: Vnitřní závit 12,91 mm (1/4")
- Spojovací konektor: jmenovitá velikost 7,2 (včetně)
- Doporučený utahovací moment: 610 Nm
- Průměr hadice (doporučeno): 10 mm
- Pracovní tlak [bar]: 6,3
- Hladina akustického výkonu (při provozním tlaku): 103,2 db(A) Lp W
- Vibrační zrychlení: 13,49 m/s²
- Povolovací moment (max.) zjištěný s velikostí šroubu M: 16
- Právý/levý chod: třístupňový (otáčení doprava)
- Rukojeť s izolací vůči chladu
- Jednoruční ovládání pro praváky a leváky

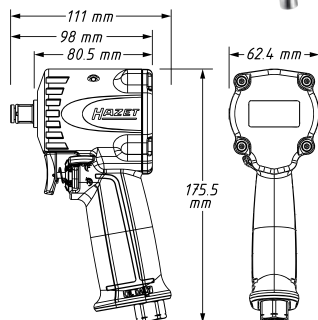

YouTube Clip

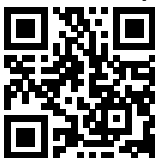

12.91 (1/4) 7.2
9000-010

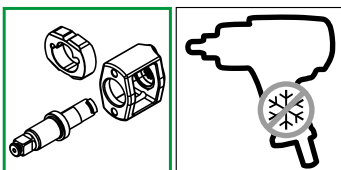

HAZET No.	max. Nm	max. Nm	l/min.	ot./min.	db (A) LpA	g	EAN-No. 4000896+	€
9012 M-1	1200	678	127,4	8800	92,2	1270	218356	220,-
Silikonový ochranný obal pro 9012 M-1								
9012 M-1-S	-	-	-	-	-	-	222735	6,85

• Povolovací moment: 1400 Nm

12½ 1/2

- Odvětrání přes rukojeť směrem dolů
- Nízké vibrace
- Jednoduché ovládání
- **Extra krátký – jen 100 mm**
- Výkonný dvojkcladikový úderník
- Vzduchová přípojka vstup: Vnitřní závit 16,41 mm (5/8")
- Spojovací konektor: jmenovitá velikost 7,2 (včetně)
- Doporučený utahovací moment: 620 Nm
- Průměr hadice (doporučeno): 10 mm
- Pracovní tlak [bar]: 6,3
- Hladina akustického výkonu (při provozním tlaku): 102 db(A) Lp W
- Vibrační zrychlení: 8,74 m/s²
- Povolovací moment (max.) zjištěný s velikostí šroubu M: 16
- Právý/levý chod: třístupňový (otáčení doprava a doleva)
- Rukojeť s izolací vůči chladu
- Závěsná spona
- Jednoruční ovládání – stejně použitelné pro praváky i leváky



YouTube Clip



9012 Rázový utahovák · extra krátký

12½ 1/2

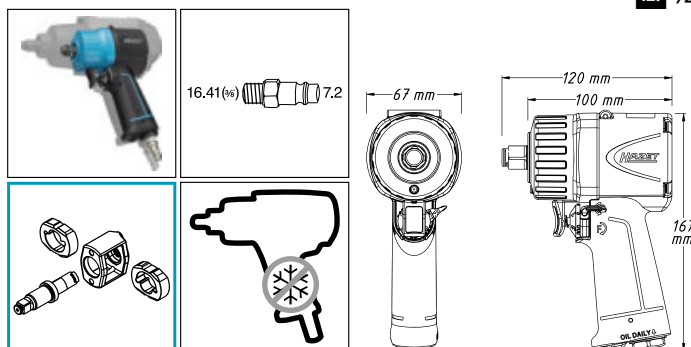

HAZET No.	max. Nm	max. Nm	l/min.	ot./min.	db (A) LpA	g	EAN-No. 4000896+	€
9012 MT	1400	745	135	9000	92,7	1320	203598	265,10

9012 ATT Twin Turbo Rázový utahovák

• Povolovací moment: 550 Nm

12½ 1/2

- Odvětrání přes rukojeť směrem dolů
- Nízké vibrace
- Jednoduché ovládání
- Kolem vlastní osy nastavitelná rukojeť / spouštěč k optimální manipulaci umožňuje zacházení v každé poloze
- Inovativní otočný mechanismus pro rozšířenou oblast použití zaručuje skvělou dostupnost
- Nízké vibrace
- Jednoduchá obsluha
- Krátká, kompaktní, zahnutá konstrukce – jen 70 mm
- Obsluha jednou rukou pro leváky a praváky
- Výkonný dvojkcladikový úderník
- Vzduchová přípojka vstup: Vnitřní závit 12,91 mm (1/4")
- Spojovací konektor: jmenovitá velikost 7,2 (včetně)
- Doporučený utahovací moment: 450 Nm
- Průměr hadice (doporučeno): 10 mm
- Pracovní tlak [bar]: 6,3
- Hladina akustického výkonu (při provozním tlaku): 101,1 db(A) Lp W
- Vibrační zrychlení: 4,89 m/s²
- Povolovací moment (max.) zjištěný s velikostí šroubu M: 16
- Právý/levý chod: jednostupňové (doprava/doleva)
- Rukojeť s izolací vůči chladu

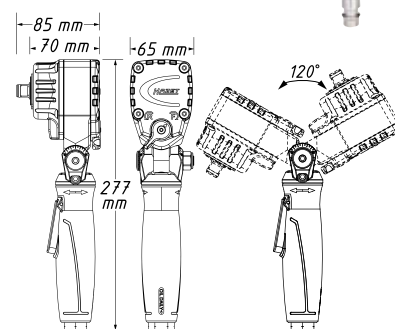

YouTube Clip

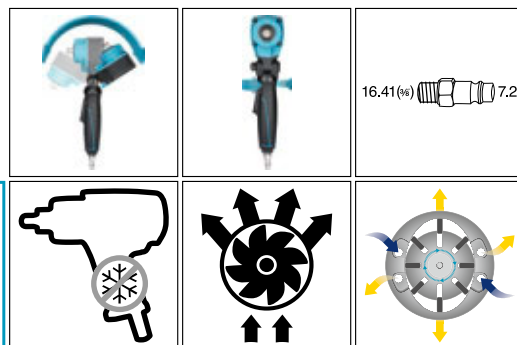

HAZET No.	max. Nm	max. Nm	l/min.	ot./min.	db (A) LpA	g	EAN-No. 4000896+	€
9012 A TT	550	500	113	8000	90,1	1300	234738	231,20



Pneumatické nářadí / stroje

Rázový utahovák



9012 Rázový utahovák

• Povolovací moment: 850 Nm

ⓔ 12½ 1/2

- Odvětrání přes rukojeť směrem dolů
- Nízké vibrace
- Jednoduché ovládání
- Výkonný kolíkový úderník
- Vzduchová přípojka vstup: Vnitřní závit 12,91 mm (1/4")
- Spojovací konektor: jmenovitá velikost 7,2 (včetně)
- Doporučený utahovací moment: 550 Nm
- Průměr hadice (doporučeno): 10 mm
- Pracovní tlak [bar]: 6,3
- Hladina akustického výkonu (při provozním tlaku): 103,1 db(A) Lp W
- Vibrační zrychlení: 7,42 m/s²
- Povolovací moment (max.) zjištěný s velikostí šroubu M: 16
- Pravý/levý chod: třístupňový (otáčení doprava), jednostupňový (otáčení doleva)
- Rukojeť s izolací vůči chladu
- Vyšší dosažený výkon díky nově vyvinutému vzduchovému motoru, jakož i lepšímu vedení vzduchu a zlepšené odezvy momentu vzduchového motoru
- Vnitřní části speciálně tepelně zpracované pro nižší opotřebení
- Ergonomicky tvarovaná rukojeť a tělo pro lepší manipulaci a obsluhu

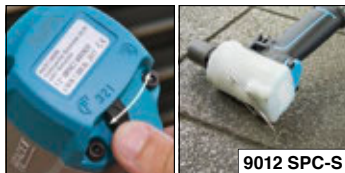

9012 SPC-S

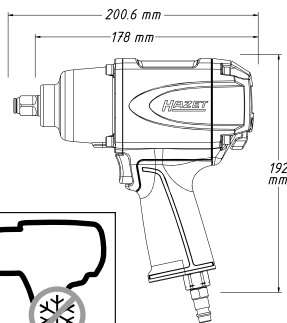
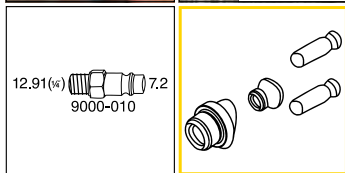

HAZET No.	max. Nm	max. Nm	l/min.	ot./min.	db (A) LpA	g	EAN-No. 4000896+	€
9012 SPC	850	750	127,4	7000	92,1	2600	119639	182,70
Silikonový ochranný obal pro 9012 SPC · 9012-1 SPC · 9012 P-1								
9012 SPC-S	-	-	-	-	-	-	222476	10,50

• Povolovací moment: 1700 Nm

ⓔ 12½ 1/2

- Odvětrání přes rukojeť směrem dolů
- Nízké vibrace
- Jednoduché ovládání
- Výkonný dvojkřídový úderník
- Vzduchová přípojka vstup: Vnitřní závit 12,91 mm (1/4")
- Spojovací konektor: jmenovitá velikost 7,2 (včetně)
- Doporučený utahovací moment: 881 Nm
- Průměr hadice (doporučeno): 10 mm
- Pracovní tlak [bar]: 6,3
- Hladina akustického výkonu (při provozním tlaku): 109 db(A) Lp W
- Vibrační zrychlení: 10,23 m/s²
- Povolovací moment (max.) zjištěný s velikostí šroubu M: 16
- Pravý/levý chod: čtyřstupňový (pravý chod), jednostupňový (levý chod)
- Rukojeť s izolací vůči chladu
- Ovládání jednou rukou díky inovativnímu přepínání na zadní straně přístroje



9012 EL-SPC-S

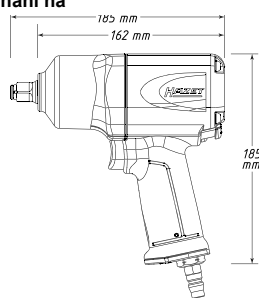

9012 Rázový utahovák

ⓔ 12½ 1/2

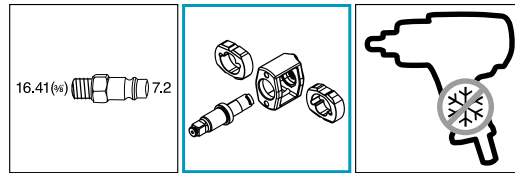

HAZET No.	max. Nm	max. Nm	l/min.	ot./min.	db (A) LpA	g	EAN-No. 4000896+	€
9012 EL-SPC	1700	1054	139	8000	98	1980	188444	268,20
Silikonový ochranný obal pro 9012 EL-SPC								
9012 EL-SPC-S	-	-	-	-	-	-	222520	10,50

9012 TT Twin Turbo Rázový utahovák

• Povolovací moment: 2200 Nm

12½ 1/2

- Odvětrání přes rukojeť směrem dolů
- Nízké vibrace
- Jednoduché ovládání
- Krátká konstrukce – jen 128 mm
- HAZET Twin Turbo technologii – vysoké točivé momenty při kompaktním způsobu konstrukce
- Inovativní 8 lamelový vzduchový motor s o 25 % vyšším výkonem úderu zaručuje maximální točivý moment
- Jednoruční ovládání pro praváky a leváky
- Výkonný dvojkřídový úderník
- Vzduchová přípojka vstup: Vnitřní závit 12,91 mm (1/4")
- Spojovací konektor: jmenovitá velikost 7,2 (včetně)
- Doporučený utahovací moment: 948 Nm
- Průměr hadice (doporučeno): 10 mm
- Pracovní tlak [bar]: 6,3
- Hladina akustického výkonu (při provozním tlaku): 110,7 db(A) Lp W
- Vibrační zrychlení: 8,69 m/s²
- Povolovací moment (max.) zjištěný s velikostí šroubu M: 16
- Pravý/levý chod: dvoustupňový (chod vpravo), jednostupňový (chod vlevo)
- Rukojeť s izolací vůči chladu

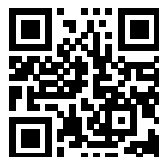

YouTube Clip

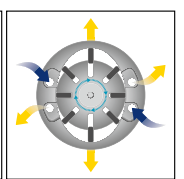
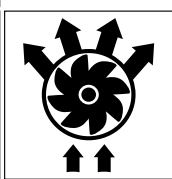
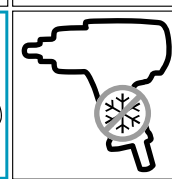
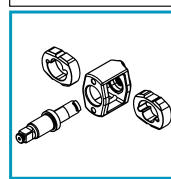
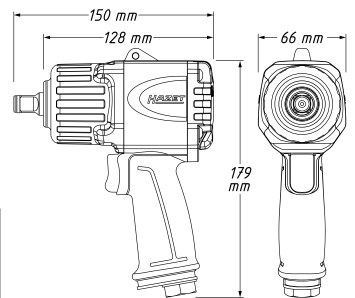

HAZET No.	max. Nm	max. Nm	l/min.	ot./min.	db (A) LpA	g	EAN-No. 4000896+	€
9012 TT	2200	1356	147,2	8300	99,7	1600	226924	267,50
Hadice tlumící hluk ke snížení hluku rázových utahováků HAZET Twin Turbo 9012 MTT · 9012 TT								
Pružinová svorka k připevnění hadice u rukojeti								
9040-012	-	-	-	-	-	-	232987	24,15



9013 Rázový utahovák

• Povolovací moment: 1890 Nm

20 3/4"

- Odvětrání přes rukojeť směrem dolů
- Nízké vibrace
- Jednoduché ovládání
- **20 mm (3/4") rázový utahovák v tělese o velikosti 12,5 mm (1/2")**
- Výkonný dvojkřídový úderník
- Vzduchová přípojka vstup: Vnitřní závit 16,41 mm (5/8")
- Spojovací konektor: jmenovitá velikost 7,2 (včetně)
- Doporučený utahovací moment: 922 Nm
- Průměr hadice (doporučeno): 10 mm
- Pracovní tlak [bar]: 6,3
- Hladina akustického výkonu (při provozním tlaku): 93 db(A) Lp W
- Vibrační zrychlení: 7,47 m/s²
- Povolovací moment (max.) zjištěný s velikostí šroubu M: 32
- Pravý/levý chod: tříступňový (otáčení doprava), jednostupňový (otáčení doleva)
- Rukojeť s izolací vůči chladu



YouTube Clip

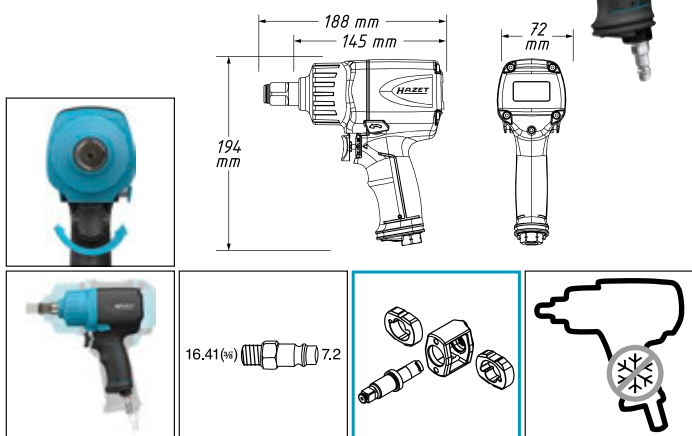

HAZET No.	max. Nm	max. Nm	l/min.	ot./min.	db(A) LpA	g	EAN-No. 4000896+	€
9013 M	1890	1085	153	7300	104	2100	212347	460,20

9013 TT Twin Turbo Rázový utahovák

• Povolovací moment: 4100 Nm

20 3/4"

- Odvětrání přes rukojeť směrem dolů
- Nízké vibrace
- Jednoduché ovládání
- Krátká konstrukce – jen 184 mm
- Nejsilnější rázový utahovák HAZET všech dob
- Odnímatelný ruční třmen, nastavitelný o 360°
- HAZET Twin Turbo technologii – vysoké točivé momenty při kompaktním způsobu konstrukce
- Inovativní 8 lamelový vzduchový motor s o 25% vyšším výkonem úderu zaručuje maximální točivý moment
- Jednoruční ovládání pro praváky a leváky
- Výkonný dvojkřídový úderník
- Vzduchová přípojka vstup: Vnitřní závit 16,41 mm (5/8")
- Spojovací konektor: jmenovitá velikost 7,2 (včetně)
- Doporučený utahovací moment: 1890 Nm
- Průměr hadice (doporučeno): 13 mm
- Pracovní tlak [bar]: 6,3
- Hladina akustického výkonu (při provozním tlaku): 110,5 db(A) Lp W
- Vibrační zrychlení: 10,69 m/s²
- Povolovací moment (max.) zjištěný s velikostí šroubu M: 32
- Pravý/levý chod: dvoustupňový (chod vpravo), jednostupňový (chod vlevo)
- Rukojeť s izolací vůči chladu



9013 TT Twin Turbo Rázový utahovák

20 3/4"



YouTube Clip

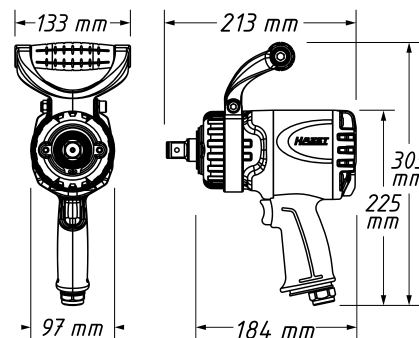

HAZET No.	max. Nm	max. Nm	l/min.	ot./min.	db(A) LpA	g	EAN-No. 4000896+	€
9013 TT	4100	2170	243,5	5200	99,5	4500	227143	700,-

Hadice tlumící hluk ke snížení hluku rázových utahováků HAZET Twin Turbo 9013 TT · 9013 Lg TT
Pružinová svorka k připevnění hadice u rukojeti

9040-013	-	-	-	-	-	-	232994	30,35
----------	---	---	---	---	---	---	--------	-------

9013 TT Twin Turbo Rázový utahovák

• Povolovací moment: 3800 Nm

20 3/4"

- Odvětrání přes rukojeť směrem dolů
- Nízké vibrace
- Jednoduché ovládání
- Délka vřetene 186 mm – k dosažení na hluboko uložené šroubení
- Nejsilnější rázový utahovák HAZET všech dob
- Odnímatelný přídržný třmen, nastavitelný o 360°
- HAZET Twin Turbo technologii – vysoké točivé momenty při kompaktním způsobu konstrukce
- Inovativní 8 lamelový vzduchový motor s o 25% vyšším výkonem úderu zaručuje maximální točivý moment
- Jednoruční ovládání pro praváky a leváky
- Výkonný dvojkřídový úderník
- Vzduchová přípojka vstup: Vnitřní závit 16,41 mm (5/8")
- Spojovací konektor: jmenovitá velikost 7,2 (včetně)
- Doporučený utahovací moment: 1758 Nm
- Průměr hadice (doporučeno): 13 mm
- Pracovní tlak [bar]: 6,3
- Hladina akustického výkonu (při provozním tlaku): 113,5 db(A) Lp W
- Vibrační zrychlení: 9,02 m/s²
- Povolovací moment (max.) zjištěný s velikostí šroubu M: 32
- Pravý/levý chod: dvoustupňový (chod vpravo), jednostupňový (chod vlevo)
- Rukojeť s izolací vůči chladu





Pneumatické nářadí / stroje

Rázový utahovák



9013 TT Twin Turbo Rázový utahovák

20 3/4"

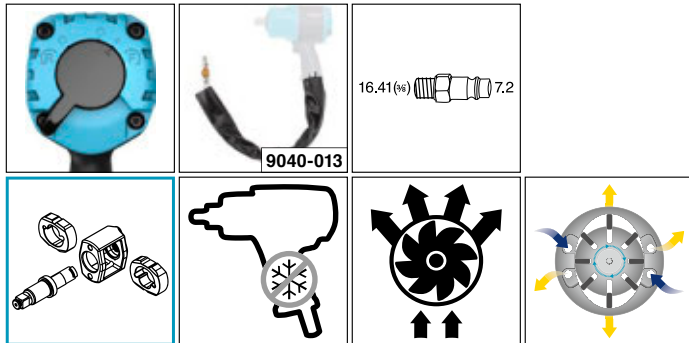
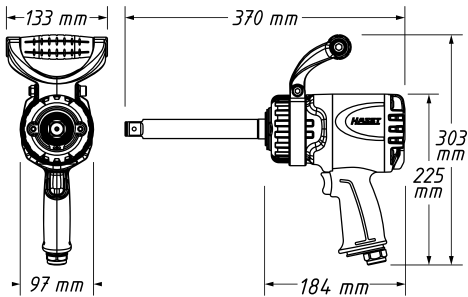

HAZET No.	max. Nm	max. Nm	l/min.	ot./min.	db (A) LpA	g	EAN-No. 4000896+	€
9013 Lg TT	3800	2020	243	5200	102,5	5500	232277	719,-
Hadice tlumící hluk ke snížení hluku rázových utahováků HAZET Twin Turbo 9013 TT - 9013 Lg TT Pružinová svorka k připevnění hadice u rukojeti								
9040-013	-	-	-	-	-	-	232994	30,35

9014 TT Twin Turbo Rázový utahovák

• Povolovací moment: 4100 Nm

25 1"

- Odvětrání přes rukojeť směrem dolů
- Nízké vibrace
- Jednoduché ovládání
- Krátká, kompaktní konstrukce
- Obsluha jednou rukou pro leváky a praváky
- Odnímatelný ruční třmen, nastavitelný o 360°
- Připoj pro hadici tlumící hluk
- HAZET Twin Turbo technologii – vysoké točivé momenty při kompaktním způsobu konstrukce
- Inovativní 8 lamelový vzduchový motor s o 25 % vyšším výkonem úderu zaručuje maximální točivý moment
- Výkonný dvojkladivový úderník
- Vzduchová přípojka vstup: Vnitřní závit 16,41 mm (5/8")
- Spojovací konektor: jmenovitá velikost 7,2 (včetně)
- Doporučený utahovací moment: 1898 Nm
- Průměr hadice (doporučeno): 13 mm
- Pracovní tlak [bar]: 6,3
- Hladina akustického výkonu (při provozním tlaku): 112,9 db(A) Lp W
- Vibrační zrychlení: 19,11 m/s²
- Povolovací moment (max.) zjištěný s velikostí šroubu M: 32
- Pravý/levý chod: dvoustupňový (chod vpravo), jednostupňový (chod vlevo)
- Rukojeť s izolací vůči chladu

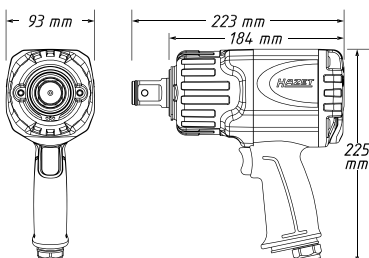

9014 TT Twin Turbo Rázový utahovák

25 1"

YouTube Clip

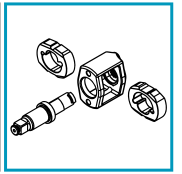
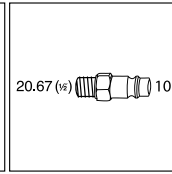
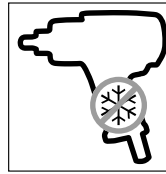
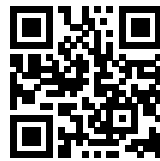

HAZET No.	max. Nm	max. Nm	l/min.	ot./min.	db (A) LpA	g	EAN-No. 4000896+	€
9014 TT	4100	2170	235	5200	101,9	4600	234684	725,-

9014 P Rázový utahovák

• Povolovací moment: 3400 Nm

25 1"

- Odvětrání přes rukojeť směrem dolů
- Nízké vibrace
- Jednoduché ovládání
- Kladivový úderník
- Vzduchová přípojka vstup: Vnitřní závit 20,67 mm (1/2")
- Spojovací konektor: jmenovitá šifka 10 (včetně)
- Doporučený utahovací moment: 2400 Nm
- Průměr hadice (doporučeno): 19 mm
- Pracovní tlak [bar]: 6,3
- Hladina akustického výkonu (při provozním tlaku): 114,5 db(A) Lp W
- Vibrační zrychlení: 15,94 m/s²
- Povolovací moment (max.) zjištěný s velikostí šroubu M: 36
- Pravý/levý chod: třístupňový (otáčení doprava a doleva)
- Rukojeť s izolací vůči chladu
- Výstup s otvorem pro zakolíkovaní nástrojů a rovněž provedený s přídržným kroužkem nástrčného klíče
- Oboustranně optimalizovaná obsluha pro praváky i leváky
- Přepínání jednou rukou
- Extrémně silný nástroj
- Optimalizovaná haptika
- Připojení vzduchu je možné u rukojeti dole a vzadu

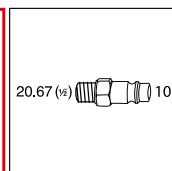
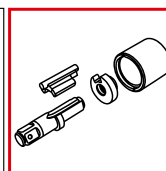
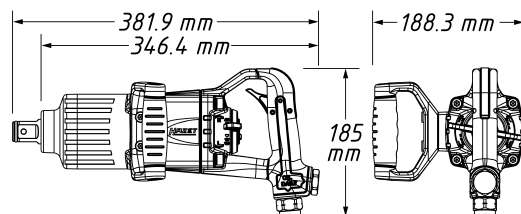
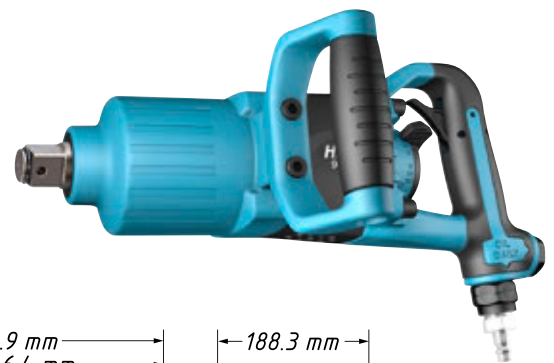

HAZET No.	max. Nm	max. Nm	l/min.	ot./min.	db (A) LpA	g	EAN-No. 4000896+	€
9014 PS-1	3400	2712	283	5500	103,5	7800	222490	1195,-



9014 P Rázový utahovák

• Povolovací moment: 3400 Nm

- Odvětrání přes rukojeť směrem dolů
- Nízké vibrace
- Jednoduché ovládání
- **Dlouhé vřeteno (240 mm)** pro optimální dosažitelnost šroubových spojení kol
- Kladivový úderník
- Vzduchová přípojka vstup: Vnitřní závit 20,67 mm (1/2")
- Spojovací konektor: jmenovitá šířka 10 (včetně)
- Doporučený utahovací moment: 2400 Nm
- Průměr hadice (doporučeno): 19 mm
- Pracovní tlak [bar]: 6,3
- Hladina akustického výkonu (při provozním tlaku): 114,5 db(A) Lp W
- Vibrační zrychlení: 15,94 m/s²
- Povolovací moment (max.) zjištěný s velikostí šroubu M: 36
- Pravý/levý chod: třístupňový (otáčení doprava a doleva)
- Rukojeť s izolací vůči chladu
- Výstup s otvorem pro zakolíkovaní nástrojů a rovněž provedený s přídržným kroužkem nástřného klíče
- Oboustranně optimalizovaná obsluha pro praváky i leváky
- Přepínání jednou rukou
- Extrémně silný nástroj
- Optimalizovaná haptika
- Připojení vzduchu je možné u rukojeti dole a vzadu

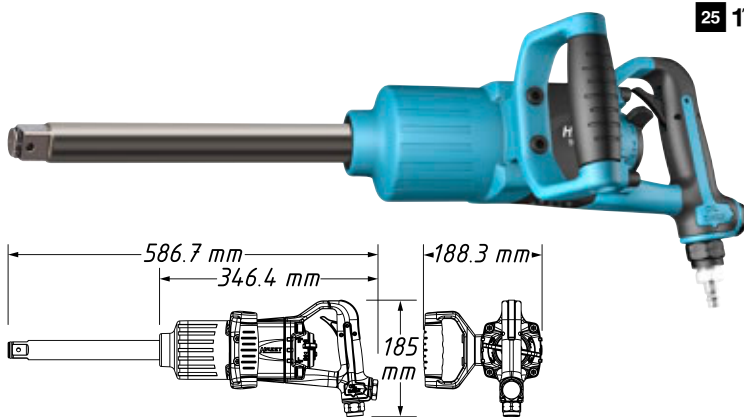

25 1'

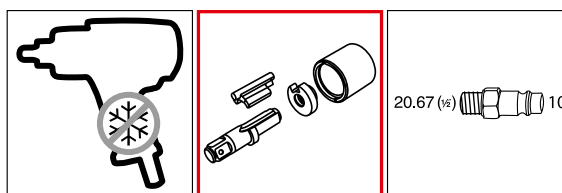

YouTube Clip



HAZET No.	max. Nm	max. Nm	l/min.	ot./min.	db(A) LpA	g	EAN-No. 4000896+	€
9014 P-1	3400	2712	283	5500	103,5	8580	218332	1206,-

Ráčnový šroubovák

9020 Pneumatická ráčna

- Nízké vibrace
- Vzduchová přípojka vstup: Vnitřní závit 12,91 mm (1/4")
- Spojovací konektor: jmenovitá velikost 7,2 (včetně)
- Pracovní tlak [bar]: 6,3
- Hladina akustického výkonu (při provozním tlaku): 89 db(A) Lp W
- Vibrační zrychlení: 3,30 m/s²
- Pravý/levý chod: jednostupňové (doprava/doleva)
- Rukojeť s izolací vůči chladu

E 6.3 1/4'

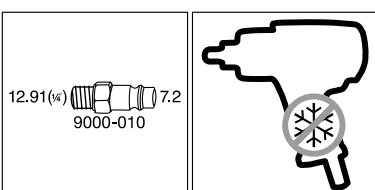
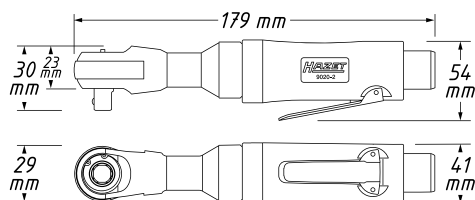

HAZET No.	max. Nm	l/min.	ot./min.	db(A) LpA	g	EAN-No. 4000896+	€
9020-2	35	180	170	83	500	109432	132,10

9020 Pneumatická miniráčna

- **Krátká konstrukce**
- **Pro ruční utažení s momentem >60 Nm**

E 6.3 1/4'

- Kompletně uzavřená hlava zabraňuje vstupu špon apod.
- Nízké vibrace
- Vzduchová přípojka vstup: Vnitřní závit 12,91 mm (1/4")
- Spojovací konektor: jmenovitá velikost 7,2 (včetně)
- Průměr hadice (doporučeno): 10 mm
- Pracovní tlak [bar]: 6,3
- Hladina akustického výkonu (při provozním tlaku): 101 db(A) Lp W
- Vibrační zrychlení: 3,30 m/s²
- Pravý/levý chod: jednostupňové (doprava/doleva)
- Rukojeť s izolací vůči chladu

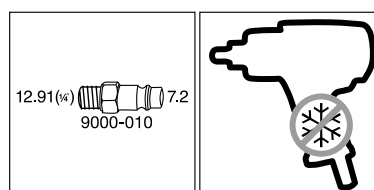
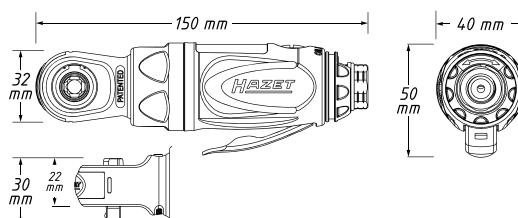

YouTube Clip



HAZET No.	max. Nm	l/min.	ot./min.	db(A) LpA	g	EAN-No. 4000896+	€
9020 P-2	40	72	250	90	500	184323	163,70



Pneumatické nářadí / stroje

Ráčnový šroubovák



9023 M Multifunkční pneumatická miniráčna

• S výměnou ráčnových hlavice lze použít pro $\frac{3}{8}$ " $\frac{1}{2}$ " a $\frac{3}{4}$ "

6.3 $\frac{1}{4}$ " 10 $\frac{3}{8}$ " $\frac{6.3}{16}$ " $\frac{1}{4}$ "

- Použití: Umožňuje s otevřeným 17 mm vnitřním šestihranem zpracování také extra dlouhých závitů
- Krátká konstrukce
- Nízké vibrace
- Odvětrání přes rukojeť směrem dolů
- Pro ruční utažení s momentem 70 Nm
- Vzduchová přípojka vstup: Vnitřní závit 12,91 mm ($\frac{1}{4}$ "
- Spojovací konektor: jmenovitá velikost 7,2 (včetně)
- Průměr hadice (doporučeno): 10 mm
- Pracovní tlak [bar]: 6,3
- Hladina akustického výkonu (při provozním tlaku): 93,8 db(A) Lp W
- Vibrační zrychlení: 3,20 m/s²
- Právý/levý chod: jednostupňové (doprava/doleva)
- Rukojeť s izolací vůči chladu

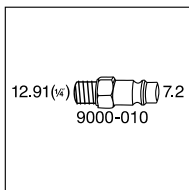
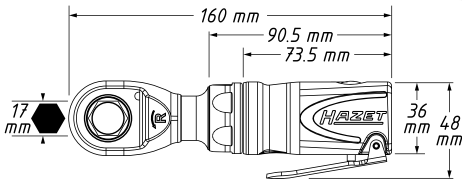

HAZET No.	max. Nm	l/min.	ot./min.	db (A) LpA	g	EAN-No. 4000896+	€
• Obsah: Průstrčná ráčna nástrčná hlavice čtyřhran 6,3 mm ($\frac{1}{4}$ palce) nástrčná hlavice čtyřhran 10 mm ($\frac{3}{8}$ palce) šestihran bit 6,3 mm ($\frac{1}{4}$ palce)							
9023 M-1	54	159	84	400	82,8	480 4 227112	189,50
• Nástrčná hlavice čtyřhran 6,3 mm ($\frac{1}{4}$ palce)							
9023 M-1-020	-	-	-	-	-	- 228225	17,95
• Nástrčná hlavice čtyřhran 10 mm ($\frac{3}{8}$ palce)							
9023 M-1-021	-	-	-	-	-	- 228232	17,95
• Šestihran bit 6,3 mm ($\frac{1}{4}$ palce)							
9023 M-1-B	-	-	-	-	-	- 228249	17,95



9021 Pneumatická ráčna

• Nízké vibrace E 10 $\frac{3}{8}$ "

- Vzduchová přípojka vstup: Vnitřní závit 12,91 mm ($\frac{1}{4}$ "
- Spojovací konektor: jmenovitá velikost 7,2 (včetně)
- Pracovní tlak [bar]: 6,3
- Hladina akustického výkonu (při provozním tlaku): 89 db(A) Lp W
- Vibrační zrychlení: 3,30 m/s²
- Právý/levý chod: jednostupňové (doprava/doleva)
- Rukojeť s izolací vůči chladu

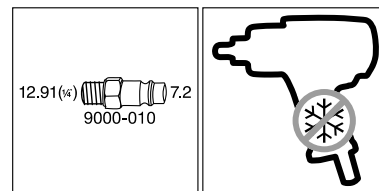
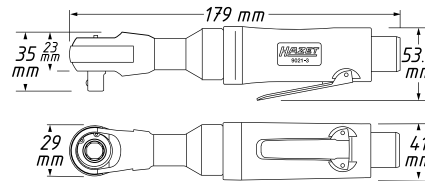

HAZET No.	max. Nm	l/min.	ot./min.	db (A) LpA	g	EAN-No. 4000896+	€
9021-3	35	180	170	83	500	116614	132,10

9021 Pneumatická miniráčna

• Krátká konstrukce E 10 $\frac{3}{8}$ "

• Pro ruční utažení s momentem >260 Nm

- Kompletně uzavřená hlava zabraňuje vstupu špon apod.
- Nízké vibrace
- Vzduchová přípojka vstup: Vnitřní závit 12,91 mm ($\frac{1}{4}$ "
- Spojovací konektor: jmenovitá velikost 7,2 (včetně)
- Průměr hadice (doporučeno): 10 mm
- Pracovní tlak [bar]: 6,3
- Hladina akustického výkonu (při provozním tlaku): 103 db(A) Lp W
- Vibrační zrychlení: 3,90 m/s²
- Právý/levý chod: jednostupňové (doprava/doleva)
- Rukojeť s izolací vůči chladu

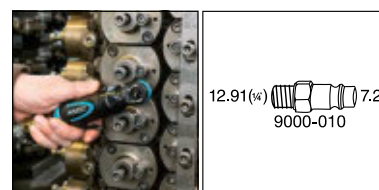
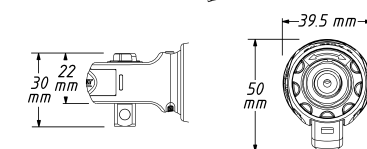
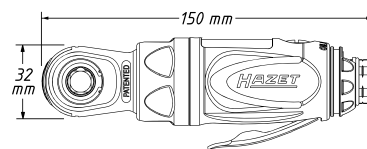

HAZET No.	max. Nm	l/min.	ot./min.	db (A) LpA	g	EAN-No. 4000896+	€
9021 P-2	54	103	300	92	500	184545	163,70



9022 Rázová pneumatická ráčna

- Maximální bezpečnost práce díky nepřítomnosti reakce úderníku **E 10** 3/8
- Šetrné vůči kloubům
- Gumový ochranný kryt hlavice ráčny na ochranu před nárazy a vniknutím nečistoty

- Použití: Použití ve stísněných montážních prostorech
- Pro ruční utažení s momentem: 260 Nm
- Výkonný dvojkřídlový úderník
- Vzduchová přípojka vstup: Vnitřní závit 12,91 mm (1/4")
- Spojovací konektor: jmenovitá velikost 7,2 (včetně)
- Průměr hadice (doporučeno): 10 mm
- Pracovní tlak [bar]: 6,3
- Hladina akustického výkonu (při provozním tlaku): 93 db(A) Lp W
- Vibrační zrychlení: 9,84 m/s²
- Právý/levý chod: jednostupňové (doprava/doleva)
- Rukojeť s izolací vůči chladu

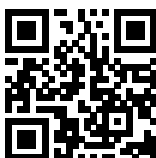

YouTube Clip

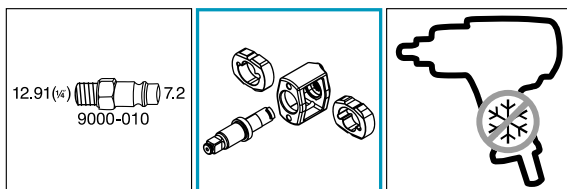
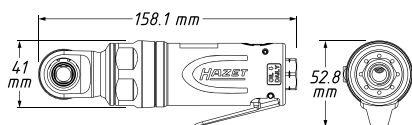
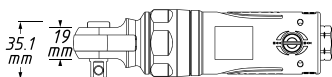

HAZET No.	max. Nm	l. mm	l/min.	ot./min.	db (A) LpA	g	EAN-No. 4000896+	€
9021 SR-1	68	158	68	500	82	670	218295	218,10



9022 Pneumatická ráčna

- Nízké vibrace **E 12** 1/2
- Vzduchová přípojka vstup: Vnitřní závit 12,91 mm (1/4")
- Spojovací konektor: jmenovitá velikost 7,2 (včetně)
- Pracovní tlak [bar]: 6,3
- Hladina akustického výkonu (při provozním tlaku): 95 db(A) Lp W
- Vibrační zrychlení: 8,50 m/s²
- Právý/levý chod: jednostupňové (doprava/doleva)
- Rukojeť s izolací vůči chladu

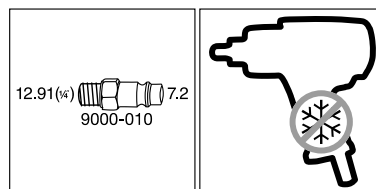
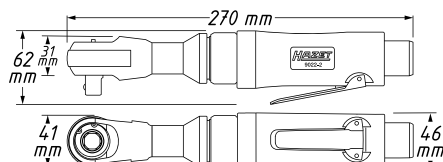

HAZET No.	max. Nm	l/min.	ot./min.	db (A) LpA	g	EAN-No. 4000896+	€
9022-2	70	180	160	88	1200	109456	132,10

Pro ruční utažení s momentem >400 Nm

E 12 1/2

- Kompletně uzavřená hlava zabraňuje vstupu špon apod.
- Nízké vibrace
- Vzduchová přípojka vstup: Vnitřní závit 12,91 mm (1/4")
- Spojovací konektor: jmenovitá velikost 7,2 (včetně)
- Průměr hadice (doporučeno): 10 mm
- Pracovní tlak [bar]: 6,3
- Hladina akustického výkonu (při provozním tlaku): 110 db(A) Lp W
- Vibrační zrychlení: 9,10 m/s²
- Právý/levý chod: jednostupňové (doprava/doleva)
- Rukojeť s izolací vůči chladu

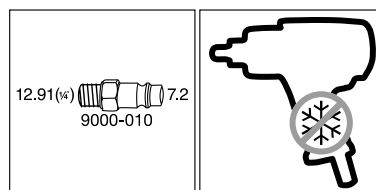
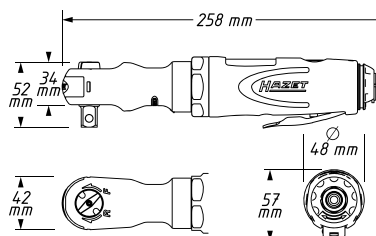

HAZET No.	max. Nm	l/min.	ot./min.	db (A) LpA	g	EAN-No. 4000896+	€
9022 P-2	108	113	280	99	1240	184538	231,20



Pneumatické nářadí / stroje

Ráčnový šroubovák



9022 Výkonná pneumatická ráčna

- Robustní dílenské provedení – vhodné zejména pro dlouhodobé použití v průmyslové výrobě
- Extra silná hlava z mimořádně tepelně zpracované speciální oceli
- Masivní hlava ráčny pro **konstantně vysoké trvalé zatížení** (sériová montáž a podobně)
- Kompletně uzavřená hlava zabraňuje vstupu špon apod.
- **Vysoká životnost** a zatížení přístroje (vysoká životnost = vysoká použitelnost nářadí)
- Pro ruční dotažení utahovacími momenty: 350 Nm (konkurenční výrobek cca 250 Nm)
- Vzduchová přípojka vstup: Vnitřní závit 12,91 mm (1/4")
- Spojovací konektor: jmenovitá velikost 7,2 (včetně)
- Hladina akustického výkonu (při provozním tlaku): 99,3 db(A) Lp W
- Vibrační zrychlení: 3,00 m/s²
- Právý/levý chod: jednostupňové (doprava/doleva)

E 12³ 1/2

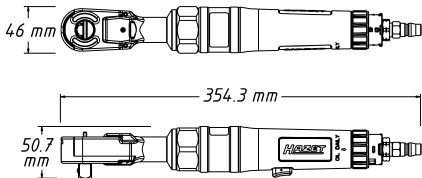

12.91(1/4) 7.2
9000-010

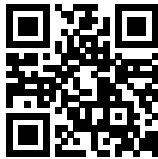

YouTube Clip

HAZET No.	max. Nm	l/min.	ot./min.	db (A) LpA	g	EAN-No. 4000896+	€
9022 P-1	95	77	160	88,3	1390	172269	169,20

- Uvolňovací páka otočná o 360°
- O 30% nižší hlasitost díky redukovatelnosti hlučnosti chodu / Quiet Mode
- Extrémně plochá hlava bez rušivé hrany kvůli přepínací páčce
- Přepínání doprava / doleva stavěcím kroužkem na rukojeti

12³ 1/2

- Extrémně silný výrobek pro použití za stísněných poměrů
- Robustní dílenské provedení
- Hlava z mimořádně tepelně zpracované speciální oceli
- **Vysoká životnost** a zatížení přístroje (vysoká životnost = vysoká použitelnost nářadí)
- Volící přepínač ke snížení emisí hluku o cca 10 db (tichý režim):
 - Hladina akustického výkonu: 92,5 db(A) Lp W
 - Hladina akustického tlaku: 81,5 dB(A) Lp A
- Pro ruční dotažení utahovacími momenty: 500 Nm (konkurenční výrobek cca 250 Nm)
- Vzduchová přípojka vstup: Vnitřní závit 12,91 mm (1/4")
- Spojovací konektor: jmenovitá velikost 7,2 (včetně)
- Průměr hadice (doporučeno): 10 mm
- Pracovní tlak [bar]: 6,3
- Hladina akustického výkonu (při provozním tlaku): 102,2 db(A) Lp W
- Vibrační zrychlení: 4,87 m/s²
- Právý/levý chod: jednostupňové (doprava/doleva)
- Rukojeť s izolací vůči chladu



9022 Výkonná pneumatická ráčna

12³ 1/2

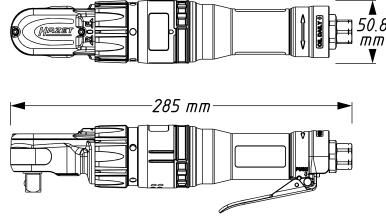

YouTube Clip

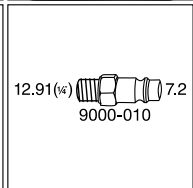

HAZET No.	max. Nm	l/min.	ot./min.	db (A) LpA	g	EAN-No. 4000896+	€	
9022-360	120	285	107,6	200	91,2	1550	209781	265,10

9022 Rázová pneumatická ráčna

E 12³ 1/2

- Maximální bezpečnost práce díky nepřítomnosti reakce úderníku
- Šetrné vůči kloubům

- Vysoký krouticí moment – cca o 30 % vyšší než u standardních přístrojů
- Otáčky – cca 3x vyšší než u standardních přístrojů
- Vhodné pro ruční dotažení utahovacími momenty → 270 Nm (konkurenční výrobek jen cca 250 Nm)
- Výkonný kolíkový úderník
- Vzduchová přípojka vstup: Vnitřní závit 12,91 mm (1/4")
- Spojovací konektor: jmenovitá velikost 7,2 (včetně)
- Průměr hadice (doporučeno): 10 mm
- Pracovní tlak [bar]: 6,3
- Hladina akustického výkonu (při provozním tlaku): 98 db(A) Lp W
- Vibrační zrychlení: 4,53 m/s²
- Právý/levý chod: jednostupňové (doprava/doleva)
- Rukojeť s izolací vůči chladu

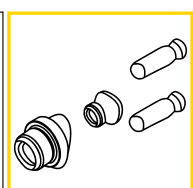
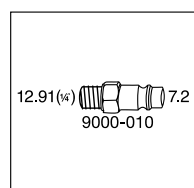
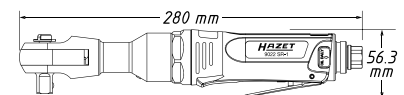

HAZET No.	max. Nm	l/min.	ot./min.	db (A) LpA	g	EAN-No. 4000896+	€	
9022 SR-1	102	280	113	400	91	1280	170593	245,60



9022 Ráčnový šroubovák · extra dlouhý

• Dosáhne i do extrémně konstrukčně skrytých prostor a toleruje vysoké síly ručního utahování

12½ 1/2

- Použití: Štíhlé provedení např. k montáži/demontáži krytů řetězů
- Pro ruční utahování s utahovacími momenty až do 400 Nm
- Nízké vibrace
- Vzduchová přípojka vstup: Vnitřní závit 12,91 mm (1/4")
- Spojovací konektor: jmenovitá velikost 7,2 (včetně)
- Průměr hadice (doporučeno): 10 mm
- Pracovní tlak [bar]: 6,3
- Hladina akustického výkonu (při provozním tlaku): 104,7 db(A) Lp W
- Vibrační zrychlení: 5,60 m/s²
- Právý/levý chod: jednostupňové (doprava/doleva)
- Rukojeť s izolací vůči chladu

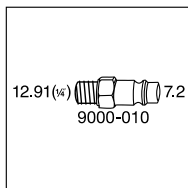

YouTube Clip

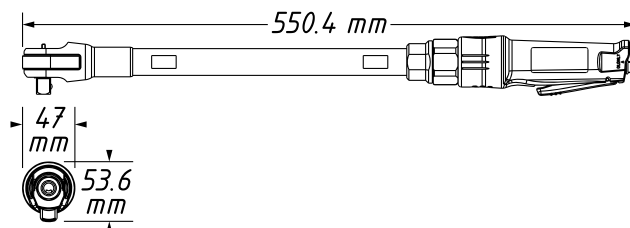
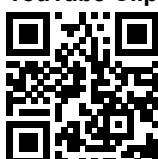

HAZET No.	max. Nm	l mm	l/min.	ot./min.	db (A) LpA	g	EAN-No. 4000896+	€
9022 P-X Lg	94,8	551	99,12	160	93,7	2100	222513	248,80

Vrtačky a brusky

9030 Vrtačka

• Odvětrání přes rukojeť směrem dolů



- Použití: Praktický nástroj zejména pro karosářské práce a průmysl
- Rychloupínací sklíčidlo bez nářadí
- Robustní tělo přístroje
- Vhodné pro trvalý provoz
- Vzduchová přípojka vstup: Vnitřní závit 12,91 mm (1/4")
- Spojovací konektor: jmenovitá velikost 7,2 (včetně)
- Průměr hadice (doporučeno): 10 mm
- Pracovní tlak [bar]: 6,3
- Hladina akustického výkonu (při provozním tlaku): 99,7 db(A) Lp W
- Vibrační zrychlení: 2,10 m/s²
- Sklíčidlo: 1–10
- Právý/levý chod: jednostupňové (doprava/doleva)
- Výkon W: 373 watt
- Rukojeť s izolací vůči chladu

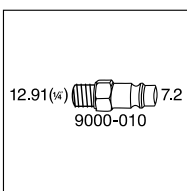

HAZET No.	l/min.	ot./min.	db (A) LpA	g	EAN-No. 4000896+	€
9030 N-1	113	2000	88,7	1000	206377	132,10

9030 Úhlová vrtačka

• Po obtížné přístupná místa



- Rychloupínací sklíčidlo
- Odvětrání přes rukojeť směrem dolů
- Vzduchová přípojka vstup: Vnitřní závit 12,91 mm (1/4")
- Spojovací konektor: jmenovitá velikost 7,2 (včetně)
- Průměr hadice (doporučeno): 10 mm
- Pracovní tlak [bar]: 6,3
- Hladina akustického výkonu (při provozním tlaku): 96 db(A) Lp W
- Vibrační zrychlení: 0,50 m/s²
- Sklíčidlo: 1–10
- Právý/levý chod: jednostupňové (doprava/doleva)
- Výkon W: 373 watt
- Rukojeť s izolací vůči chladu

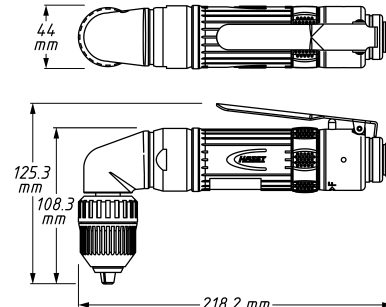
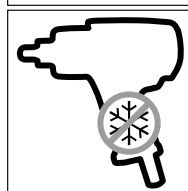
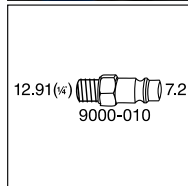

HAZET No.	l/min.	ot./min.	db (A) LpA	g	EAN-No. 4000896+	€
9030 N-5	113	1400	85	1200	205554	172,70



Pneumatické nářadí / stroje

Vrtačky a brusky



9030 Vrtačka

• Snadno ovladatelný nástroj se sklíčidlem vrtáku 1–13 mm



- Použití: Karosářské práce a průmysl
- Odvětrání přes rukojeť směrem dolů
- Rychloupínací sklíčidlo bez nářadí
- Robustní tělo přístroje
- Vhodné pro trvalý provoz
- Vzduchová přípojka vstup: Vnitřní závit 12,91 mm (1/4")
- Spojovací konektor: jmenovitá velikost 7,2 (včetně)
- Průměr hadice (doporučeno): 10 mm
- Pracovní tlak [bar]: 6,3
- Hladina akustického výkonu (při provozním tlaku): 99,4 db(A) Lp W
- Vibrační zrychlení: 1,20 m/s²
- Sklíčidlo: 1–13
- Pravý/levý chod: jednostupňově (doprava/doleva)
- Výkon W: 373 watt
- Rukojeť s izolací vůči chladu

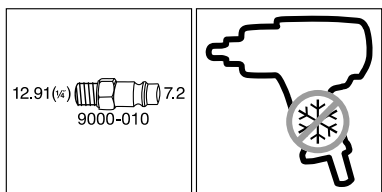
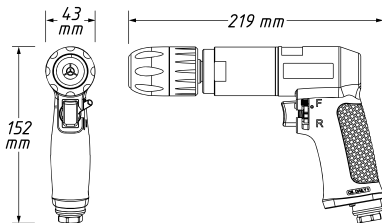

HAZET No.	l/min.	ot./min.	db (A) LpA	g	EAN-No. 4000896+	€
9030 P-1	113	800	88,4	1300	212354	170,-

9032 Stopková mikrobruska

• Precizní opracování obrobků také v extrémně stísněných prostorových podmínkách



- Délka hadice: 1500 mm
- Vzduchová přípojka vstup: Vnitřní závit 12,91 mm (1/4")
- Spojovací konektor: jmenovitá velikost 7,2 (včetně)
- Průměr hadice (doporučeno): 5 mm
- Pracovní tlak [bar]: 6,3
- Hladina akustického výkonu (při provozním tlaku): 86,4 db(A) Lp W
- Vibrační zrychlení: 0,80 m/s²
- Sklíčidlo: 3 mm
- Výkon W: 190 watt



YouTube Clip

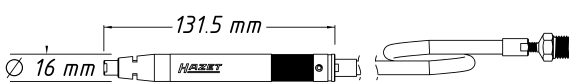

9032 Stopková mikrobruska

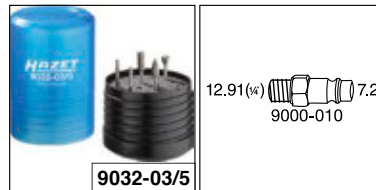

HAZET No.	l/min.	ot./min.	db (A) LpA	g	€	EAN-No. 4000896+
9032 M	75	60000	80,4	230	113,80	195152
9032-03/5	-	-	-	-	100,60	222483

9032 Stopková minibruska

• Tichý provoz: integrovaná odvětrávací hadice odvádí odpadní vzduch od obrobku a tlumí hluk

- Použití: Přesná práce s 3 mm a 6 mm brousícími nástroji i za stísněných poměrů
- Štíhlý tvar
- 6 mm sklíčidlo s adaptérem 3 mm k uchycení obou rozměrů brousícího nástroje
- Délka nástroje: 150 mm
- Průměr nástroje: 22,2 mm
- Délka hadice: 1500 mm
- Vzduchová přípojka vstup: Vnitřní závit 12,91 mm (1/4")
- Spojovací konektor: jmenovitá velikost 7,2 (včetně)
- Průměr hadice (doporučeno): 5 mm
- Pracovní tlak [bar]: 6,3
- Hladina akustického výkonu (při provozním tlaku): 85,8 db(A) Lp W
- Vibrační zrychlení: 1,80 m/s²
- Sklíčidlo: 6
- Výkon W: 224 watt

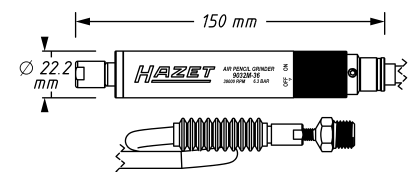
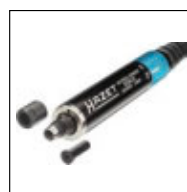

HAZET No.	l/min.	ot./min.	db (A) LpA	g	€	EAN-No. 4000896+
9032 M-36	43,7	30000	78,7	380	167,-	209606
9032-03/5	-	-	-	-	100,60	222483
9032-06/3	-	-	-	-	81,55	222667



9032 Stopková bruska · přímá

• Lehký, dobře ovladatelný přístroj k broušení, leštění broušením, hlazení a odhrotování

(E)

- **Přímé provedení**
- Plynulá regulace otáček pomocí regulačního kolečka na horní straně přístroje
- Výstup vzduchu přestavitelný o 360°
- Vzduchová přípojka vstup: Vnitřní závit 12,91 mm (1/4")
- Spojovací konektor: jmenovitá velikost 7,2 (včetně)
- Průměr hadice (doporučeno): 10 mm
- Pracovní tlak [bar]: 6,3
- Hladina akustického výkonu (při provozním tlaku): 85 db(A) Lp W
- Vibrační zrychlení: 0,40 m/s²
- Sklíčidlo: 6 mm
- Výkon W: 224 watt
- Rukojeť s izolací vůči chladu

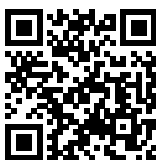
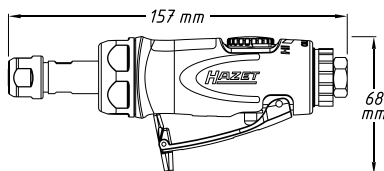

YouTube Clip

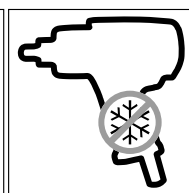
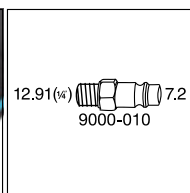

HAZET No.	l/min.	ot./min.	db(A) LpA	g	□	EAN-No. 4000896+	€
9032 N-1	74	2000–25000	79	400	–	189359	118,40
• Náhradní sklíčidlo pro 9032 M-1 · 9032 M-5 · 9032 N-1 · 9032 N-5 · 9032 P-1							
• Ø 3 mm							
9032-03 S	–	–	–	–	–	228928	10,20
• Sada s 3 různými frézami ve válcovém, kuželovitém a kulovém tvaru							
• Průměr hlavy (válcový tvar): 10 mm							
• Průměr hlavy (kulový tvar): cca 9 mm							
9032-06/3	–	–	–	–	3	222667	81,55

9032 Stopková bruska · zahnutá

• Broušení, leštění broušením, hlazení a odhrotování i ve stísněných podmínkách

(E)

- **Zahnuté provedení**
- Plynulá regulace otáček pomocí regulačního kolečka na horní straně přístroje
- Výstup vzduchu přestavitelný o 360°
- Vzduchová přípojka vstup: Vnitřní závit 12,91 mm (1/4")
- Spojovací konektor: jmenovitá velikost 7,2 (včetně)
- Průměr hadice (doporučeno): 10 mm
- Pracovní tlak [bar]: 6,3
- Hladina akustického výkonu (při provozním tlaku): 82 db(A) Lp W
- Vibrační zrychlení: 0,50 m/s²
- Sklíčidlo: 6 mm
- Výkon W: 224 watt
- Rukojeť s izolací vůči chladu



YouTube Clip

9032 Stopková bruska · zahnutá

(E)

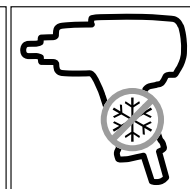
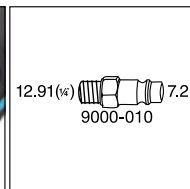
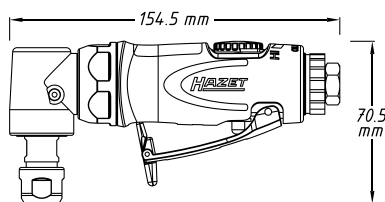

HAZET No.	l/min.	ot./min.	db(A) LpA	g	□	EAN-No. 4000896+	€
9032 N-5	74	2000–20000	78	500	–	198788	142,40
• Náhradní sklíčidlo pro 9032 M-1 · 9032 M-5 · 9032 N-1 · 9032 N-5 · 9032 P-1							
• Ø 3 mm							
9032-03 S	–	–	–	–	–	228928	10,20
• Sada s 3 různými frézami ve válcovém, kuželovitém a kulovém tvaru							
• Průměr hlavy (válcový tvar): 10 mm							
• Průměr hlavy (kulový tvar): cca 9 mm							
9032-06/3	–	–	–	–	3	222667	81,55

9032 Stopková bruska · přímá

• Extrémně výkonově silný přístroj (700 watt)

(E)

- Použití: Broušení, hlazení, leštění a odhrotování
- **Přímé provedení**
- Vysoký provozní komfort
- Ergonomický design
- Vzduchová přípojka vstup: Vnitřní závit 12,91 mm (1/4")
- Spojovací konektor: jmenovitá velikost 7,2 (včetně)
- Průměr hadice (doporučeno): 10 mm
- Pracovní tlak [bar]: 6,3
- Hladina akustického výkonu (při provozním tlaku): 98 db(A) Lp W
- Vibrační zrychlení: 0,46 m/s²
- Sklíčidlo: 6
- Výkon W: 700 watt
- Rukojeť s izolací vůči chladu



YouTube Clip

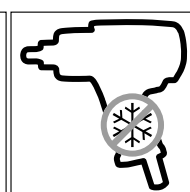
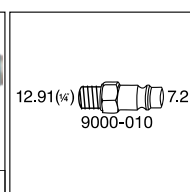
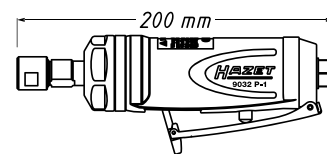
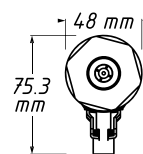

HAZET No.	l/min.	ot./min.	db(A) LpA	g	□	EAN-No. 4000896+	€
9032 P-1	150	22000	87	800	–	190508	232,50
• Náhradní sklíčidlo pro 9032 M-1 · 9032 M-5 · 9032 N-1 · 9032 N-5 · 9032 P-1							
• Ø 3 mm							
9032-03 S	–	–	–	–	–	228928	10,20



Pneumatické nářadí / stroje

Vrtačky a brusky



9032 Stopková bruska · přímá



HAZET No.	l/min.	ot./min.	db (A) LpA	g	EAN-No. 4000896+	€
9000-040	-	-	88	-	195350	41,80
9032-06/3	-	-	-	3	222667	81,55

- Kloub otočný o 360° ve 2 osách
- Regulace průtoku vzduchu pomocí regulačního kolečka
- Sada s 3 různými frézami ve válcovém, kuželovitém a kulovém tvaru
- Průměr hlavy (válcový tvar): 10 mm
- Průměr hlavy (kulový tvar): cca 9 mm

9032 Stopková bruska · přímá · dlouhá

• Přímé, dlouhé provedení pro lepší manipulaci / vedení

- Použití: Dobře ovladatelný přístroj k broušení, leštění broušením, hlazení a odhroťování
- Plynulá regulace otáček pomocí regulačního kolečka na horní straně přístroje
- Čtyřčelistové sklíčidlo
- Široká styčná plocha spouště pro snadnou manipulaci
- Optimalizovaný převod spouště nabízí nejlepší dávkování
- Vzduchová přípojka vstup: Vnitřní závit 12,91 mm (1/4")
- Spojovací konektor: jmenovitá velikost 7,2 (včetně)
- Průměr hadice (doporučeno): 10 mm
- Pracovní tlak [bar]: 6,3
- Hladina akustického výkonu (při provozním tlaku): 78 db(A) Lp W
- Vibrační zrychlení: 0,50 m/s²
- Sklíčidlo: 6 mm
- Výkon W: 360 watt
- Rukojeť s izolací vůči chladu

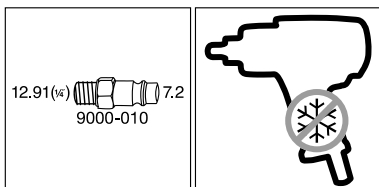
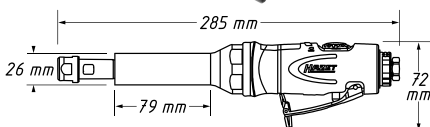

HAZET No.	l/min.	ot./min.	db (A) LpA	g	EAN-No. 4000896+	€
9032 Lg-1	99	2000-22000	81	600	209675	160,30
9032-06/3	-	-	-	3	222667	81,55

- Sada s 3 různými frézami ve válcovém, kuželovitém a kulovém tvaru
- Průměr hlavy (válcový tvar): 10 mm
- Průměr hlavy (kulový tvar): cca 9 mm

9032 Stopková minibruska · přímá

• Pro práce ve zúžených prostorech

- Použití: Extrémně lehký, dobře ovladatelný přístroj k broušení, leštění broušením, hlazení a odhroťování
- Přímé provedení
- Odvětrání přes rukojeť směrem dolů
- Vzduchová přípojka vstup: Vnitřní závit 12,91 mm (1/4")
- Spojovací konektor: jmenovitá velikost 7,2 (včetně)
- Průměr hadice (doporučeno): 10 mm
- Pracovní tlak [bar]: 6,3
- Hladina akustického výkonu (při provozním tlaku): 93,4 db(A) Lp W
- Vibrační zrychlení: 1,80 m/s²
- Sklíčidlo: 6 mm
- Výkon W: 224 watt
- Rukojeť s izolací vůči chladu

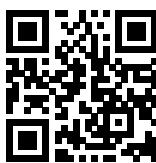

YouTube Clip



9032 Stopková minibruska · přímá

12.91(1/4) 7.2 9000-010

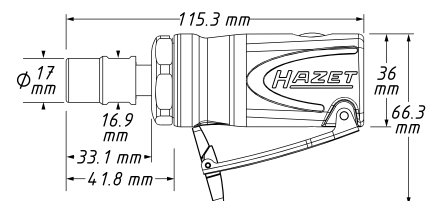

HAZET No.	l/min.	ot./min.	db (A) LpA	g	EAN-No. 4000896+	€
9032 M-1	84	25000	82,4	330	227099	90,-
9032-03 S	-	-	-	-	228928	10,20
9032-06/3	-	-	-	3	222667	81,55

- Náhradní sklíčidlo pro 9032 M-1 · 9032 M-5 · 9032 N-1 · 9032 N-5 · 9032 P-1
- Ø 3 mm

- Sada s 3 různými frézami ve válcovém, kuželovitém a kulovém tvaru
- Průměr hlavy (válcový tvar): 10 mm
- Průměr hlavy (kulový tvar): cca 9 mm

9032 Stopková minibruska · zahnutá

• Vysoce zatížitelná multiložisková převodovka s 2,5násobně delší životností v porovnání s převodovkami běžnými na trhu

- Použití: Extrémně lehký, dobře ovladatelný přístroj k broušení, leštění broušením, hlazení a odhroťování
- Zahnuté provedení pro práce ve zúžených prostorech
- Odvětrání přes rukojeť směrem dolů
- Vzduchová přípojka vstup: Vnitřní závit 12,91 mm (1/4")
- Spojovací konektor: jmenovitá velikost 7,2 (včetně)
- Průměr hadice (doporučeno): 10 mm
- Pracovní tlak [bar]: 6,3
- Hladina akustického výkonu (při provozním tlaku): 92,9 db(A) Lp W
- Vibrační zrychlení: 5,10 m/s²
- Sklíčidlo: 6 mm
- Výkon W: 224 watt
- Rukojeť s izolací vůči chladu

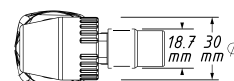
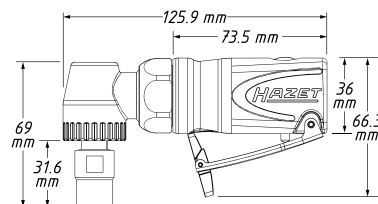

12.91(1/4) 7.2 9000-010



YouTube Clip

HAZET No.	l/min.	ot./min.	db (A) LpA	g	EAN-No. 4000896+	€
9032 M-5	84	18000	81,9	480	227105	126,-
9032-03 S	-	-	-	-	228928	10,20
9032-06/3	-	-	-	3	222667	81,55

- Náhradní sklíčidlo pro 9032 M-1 · 9032 M-5 · 9032 N-1 · 9032 N-5 · 9032 P-1
- Ø 3 mm

- Sada s 3 různými frézami ve válcovém, kuželovitém a kulovém tvaru
- Průměr hlavy (válcový tvar): 10 mm
- Průměr hlavy (kulový tvar): cca 9 mm



9033 Excentrická bruska

• Odsávání prachu



- Včetně odsávací hadice (2,0 m) a záchytného sáčku
- Plynulá regulace otáček
- Nízká konstrukční výška a lehké kompozitové těleso
- Brusný talíř s 15 otvory, Ø 150 mm se suchým zipem
- Neklouzavá rukojeť
- Vzduchová přípojka vstup: Vnitřní závit 12,91 mm (1/4")
- Spojovací konektor: jmenovitá velikost 7,2 (včetně)
- Pracovní tlak [bar]: 6,3
- Brusný zdvih: 5 mm
- Výkon W: 375 watt

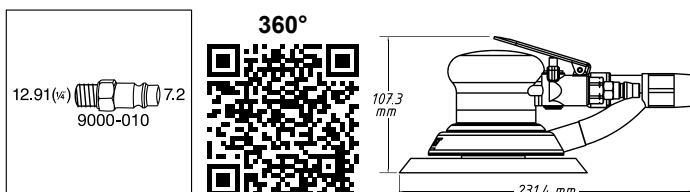

HAZET No.	l/min.	ot./min.	db(A) LpA	g	EAN-No. 4000896+	€
9033-2	57	12000	88,8	900	156337	259,20

Brusné kotouče

pro excentrickou brusku 9033-1 a -2
6 otvorů.

Pro zpracování kovů. Ø 150 mm.

Obsah balení 10 kusů

Zrnitost 80

9033-180/10 - - - 161 139330 13,60

Zrnitost 100

9033-1100/10 - - - 133 139347 13,-

Zrnitost 120

9033-1120/10 - - - 139 139354 13,-

Zrnitost 150

9033-1150/10 - - - 123 139361 13,-

15dířový brusný talíř

Pro excentrickou brusku 9033-2

• Střední tvrdost s fibrovým zadním dílem

• Uchycení suchým zipem

• Ø 150 mm se závitem 5/16"

9033-020 - - - 170 156351 60,80

9033 Pásová bruska

• Plynulá regulace otáček regulátorem otáček na hřbetu rukojeti

- Použití: Pro úzké plochy (šířka pásu 10 mm)
- Aretace pro rychlou výměnu pásů
- Pro brusné pásy 10 x 330 mm
- Automatické seřazení pásu
- Jemné seřazení pásu
- Chod pásu otočný o 360°
- Rychlost pásu: 1370 m/min
- Vč. zahnutého klíče pro jemné seřazení pásu a nastavení úhlu v rukojeti
- Vzduchová přípojka vstup: Vnitřní závit 12,91 mm (1/4")
- Spojovací konektor: jmenovitá velikost 7,2 (včetně)
- Průměr hadice (doporučeno): 10 mm
- Pracovní tlak [bar]: 6,3
- Hladina akustického výkonu (při provozním tlaku): 94,8 db(A) Lp W
- Vibrační zrychlení: 1,88 m/s²
- Výkon W: 417,6 watt
- Rukojeť s izolací vůči chladu



9033 Pásová bruska

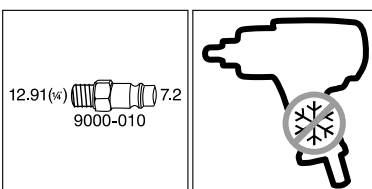
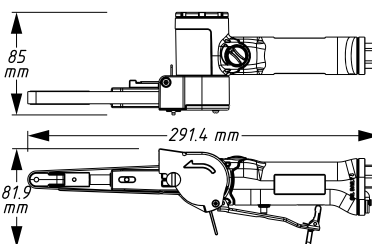

HAZET No.	l/min.	ot./min.	db(A) LpA	g	EAN-No. 4000896+	€
9033 N-4	94	19000	83,8	810	210183	200,80

Brusné pásy

pro pásovou brusku 9033-4
330 x 10 mm. Obsah balení 10 kusů.

Zrnitost 80

9033-480/10 - - - 39 139101 16,95

Zrnitost 100

9033-4100/10 - - - 35 139118 16,95

Zrnitost 120

9033-4120/10 - - - 32 139125 16,95

9033 Sada Mini excentrické brusky

• Po obtížně přístupná místa a opravné práce



- 36dílná sada, obsah:
 - 1 excentrická bruska
 - 2 brusné talíře 50 mm (2") a 76,2 mm (3")
 - Vždy 10 brusných kotoučů zrnitost 320 / 400 / 600
 - 1 nastavovací klíč
- Uchycení suchým zipem
- Brusný talíř závit: M6
- Vzduchová přípojka vstup: Vnitřní závit 12,91 mm (1/4")
- Spojovací konektor: jmenovitá velikost 7,2 (včetně)
- Průměr hadice (doporučeno): 10 mm
- Pracovní tlak [bar]: 6,3
- Hladina akustického výkonu (při provozním tlaku): 93 db(A) Lp W
- Vibrační zrychlení: 0,77 m/s²
- Výkon W: 238 watt
- Rukojeť s izolací vůči chladu

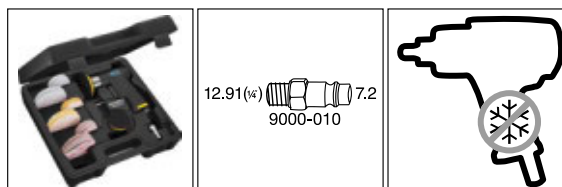
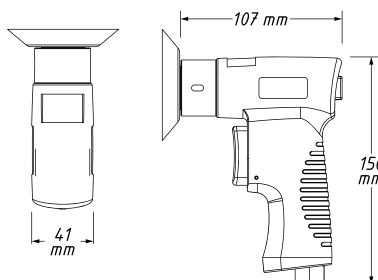



Pneumatické nářadí / stroje

Vrtačky a brusky



9033 Sada Mini excentrické brusky



HAZET No.	l/min.	ot./min.	db(A) LpA	g	EAN-No. 4000896+	€
9033 N-5	79	15000	80	640	205585	203,-
• 10 kusů náhradních brusných polštářků, zmitost 320, průměr 50 mm						
9033-5-01/10	-	-	-	10	160525	7,20
• 10 kusů náhradních brusných polštářků, zmitost 400, průměr 50 mm						
9033-5-02/10	-	-	-	7	160730	7,20
• 10 kusů náhradních brusných polštářků, zmitost 600, průměr 50 mm						
9033-5-03/10	-	-	-	18	160747	7,20
• 10 kusů náhradních brusných polštářků, zmitost 320, průměr 75 mm						
9033-5-04/10	-	-	-	21	160754	9,30
• 10 kusů náhradních brusných polštářků, zmitost 400, průměr 75 mm						
9033-5-05/10	-	-	-	14	160761	9,30
• 10 kusů náhradních brusných polštářků, zmitost 600, průměr 75 mm						
9033-5-06/10	-	-	-	20	160778	9,30

9033 Multibruska

• Multibruska pro použití s kartáčovými pásy, eliminátorových kotoučů a odstraňovačů fólií

- Použití: Odstraňování konzervace spodku vozidla, těsnící hmoty, rzi, koroze, ulpělých nečistot, laku, folií, popisů a barvy
- Plynulá regulace rychlosti regulátorem otáček na hřbetu rukojeti
- Nastavitelná rukojeť 180°
- Velikost vřetena: 9 mm (Hex)
- Dodává se bez příslušenství
- Vzduchová přípojka vstup: Vnitřní závit 12,91 mm (1/4")
- Spojovací konektor: jmenovitá velikost 7,2 (včetně)
- Průměr hadice (doporučeno): 10 mm
- Pracovní tlak [bar]: 6,3
- Hladina akustického výkonu (při provozním tlaku): 82 db(A) Lp W
- Vibrační zrychlení: 0,80 m/s²
- Výkon W: 370 watt
- Rukojeť s izolací vůči chladu

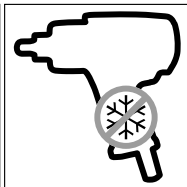
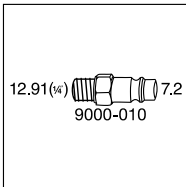
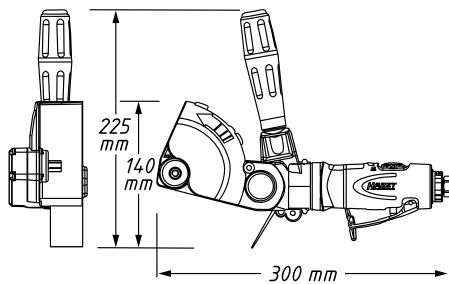

9033 Multibruska



HAZET No.	l/min.	ot./min.	db(A) LpA	g	EAN-No. 4000896+	€
9033 N-6	102	4000	79	1200	209743	371,10
• 5 ks pryžových odstraňovačů fólií (světlejší provedení)						
• Je potřeba adaptér 9033-6-010						
9033-6-01/5	-	-	-	1290	160167	120,30
• 5 kusů pryžových odstraňovačů fólií (tmavší provedení)						
• Pro vodou ředitelné laky						
• Je potřeba adaptér 9033-6-010						
9033-6-01 A/5	-	-	-	1280	160228	120,30
• 5 kusů kartáčových pásů 23 mm širokých, hrubé zahnuté hroty						
• Odstranění ochrany podvozku proti korozi, těsnících hmot a laku, s hrubým pískovacím efektem						
• Je potřeba adaptér 9033-6-010						
9033-6-02/5	-	-	-	280	160174	83,35
• 5 kusů kartáčových pásů 11 mm širokých, hrubé zahnuté hroty						
• Odstranění ochrany podvozku proti korozi, těsnících hmot a laku, s hrubým pískovacím efektem						
• Je potřeba adaptér 9033-6-011						
9033-6-03/5	-	-	-	140	160181	83,35
• 5 ks porézních kotoučů						
• Je potřeba adaptér 9033-6-041, resp. 9033-6-040						
9033-6-04/5	-	-	-	150	160198	56,70
• 5 kusů kartáčových pásů 11 mm širokých, jemné rovné hroty						
• Odstraňování laků, ulpělých nánosů a rzi, bez pískovacího efektu						
• Je potřeba adaptér 9033-6-011						
9033-6-05/5	-	-	-	120	160204	83,35
• 5 kusů kartáčových pásů 23 mm širokých, jemné rovné hroty						
• Odstraňování laků, ulpělých nánosů a rzi, bez pískovacího efektu						
• Je potřeba adaptér 9033-6-010						
9033-6-06/5	-	-	-	260	160211	83,35
• 1 kus adaptér, 23 mm široký pro kartáčové pásy 9033-6-02/5 · 9033-6-06/5 a odstraňovače fólií 9033-6-01/5 · 9033-6-01 A/5						
9033-6-010	-	-	-	-	213672	22,45
• 1 kus adaptér, 11 mm široký pro kartáčové pásy 9033-6-03/5 · 9033-6-05/5						
9033-6-011	-	-	-	-	213665	22,45
• 1 kus adaptér pro dvojité porézní kotouče 9033-6-04/5						
9033-6-040	-	-	-	-	213641	22,50
• 1 kus adaptér pro jednoduché porézní kotouče 9033-6-04/5						
9033-6-041	-	-	-	-	213658	22,50



9033 Sada Mini leštičky

Po obtížně přístupná místa a opravné práce

- 6dílná sada, obsah:
 - 1 leštička
 - 1 kotouč pro mokré broušení se suchým zipem, Ø 75 mm
 - 1 plast. kotouč měkký (žlutý)
 - 1 plast. kotouč tvrdý (bílý)
 - 1 houba z jehněčí kůže
 - 1 nastav. klíč
- Brusný talíř závit M6
- Vzduchová přípojka vstup: Vnitřní závit 12,91 mm (1/4")
- Spojovací konektor: jmenovitá velikost 7,2 (včetně)
- Průměr hadice (doporučeno): 10 mm
- Pracovní tlak [bar]: 6,3
- Hladina akustického výkonu (při provozním tlaku): 96,76 db(A) Lp W
- Vibrační zrychlení: 2,43 m/s²
- Výkon W: 238 watt
- Rukojeť s izolací vůči chladu

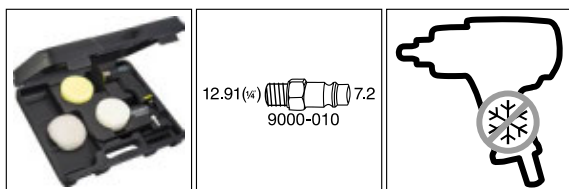
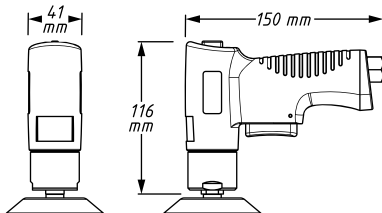

HAZET No.	l/min.	ot./min.	db (A) LpA	g	EAN-No. 4000896+	€
9033 N-9	91	3200	85,76	720	205561	203,-
• 5 ks plastových kotoučků žlutý tvrdý pěnový kotouček k leštění v první pracovní operaci						
9033-9-02/5	-	-	-	50	160556	72,-
• 5 ks plastových kotoučků bílých měkkých, k leštění ve druhé pracovní operaci						
9033-9-03/5	-	-	-	80	160563	72,-
• Kotouče z jehněčí kůže 5 kusů Pro 9033-9						
9033-9-04/5	-	-	-	80	160570	69,40

9033 Úhlová bruska

- Postranní rukojeť použitelná vpravo i vlevo
- Rychlé nastavení ochranného krytu bez nářadí
- Pro tloušťku brusného kotouče 0,8–6 mm
- Závit vřetena: M 14 x 2
- **Pro brusné kotouče 125x22 mm**
- Aretace vřetene
- Vzduchová přípojka vstup: Vnitřní závit 12,91 mm (1/4")
- Spojovací konektor: jmenovitá velikost 7,2 (včetně)
- Průměr hadice (doporučeno): 10 mm
- Pracovní tlak [bar]: 6,3
- Hladina akustického výkonu (při provozním tlaku): 96 db(A) Lp W
- Vibrační zrychlení: 6,50 m/s²
- Výkon W: 671 watt
- Rukojeť s izolací vůči chladu

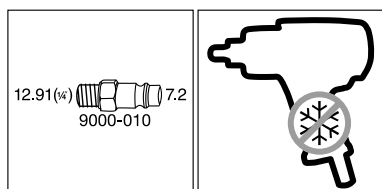

9033 Úhlová bruska

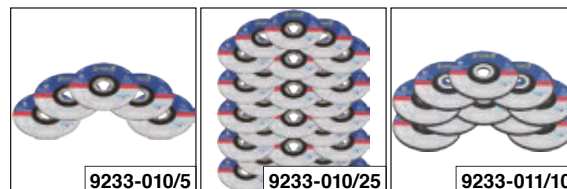
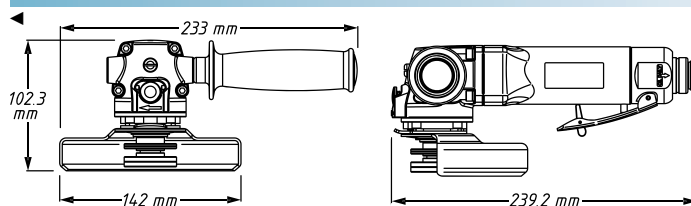

HAZET No.	l/min.	ot./min.	db (A) LpA	g	EAN-No. 4000896+	€
9033 N-7	113	12000	85	2000	205547	280,90
• Sada rozbrušovacích kotoučů, 5dílná						
• Pro 9233-7 · 9233-7/4						
9233-010/5	-	-	-	-	5 219063	9,15
• Sada rozbrušovacích kotoučů, 25dílná						
• Pro 9233-7 · 9233-7/4						
9233-010/25	-	-	-	-	25 219070	38,90
• Sada hrubovacích kotoučů, 10dílná						
• Pro 9233-7 · 9233-7/4						
9233-011/10	-	-	-	-	10 219087	27,45

9033 Hlubková bruska

Velmi plochá konstrukce brusné hlavy – jen 46 mm



- Použití: Pro nepřístupná místa, pro oddělení plechu a oceli
- Zvlášť vhodná pro použití ve zúžených prostorech, např. k řezání svorek na trubce výfuku v zamontovaném stavu
- Nízké vibrace
- Rychlé nastavení krytu bez použití nářadí
- Knoflík k zablokování pohonu (aretace vřetene) pro jednoduchou výměnu kotouče
- Průměr upínadla kotoučů: 10 mm (3/8")
- Včetně 1 oddělovacího kotouče 100x0,8x9,53 mm
- Vzduchová přípojka vstup: Vnitřní závit 12,91 mm (1/4")
- Spojovací konektor: jmenovitá velikost 7,2 (včetně)
- Průměr hadice (doporučeno): 10 mm
- Pracovní tlak [bar]: 6,3
- Hladina akustického výkonu (při provozním tlaku): 100,5 db(A) Lp W
- Vibrační zrychlení: 3,65 m/s²
- Výkon W: 700 watt
- Rukojeť s izolací vůči chladu



YouTube Clip

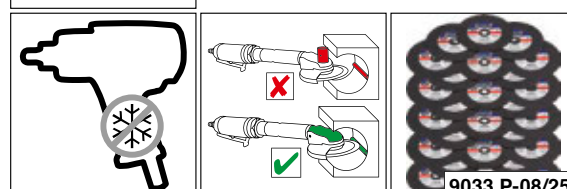
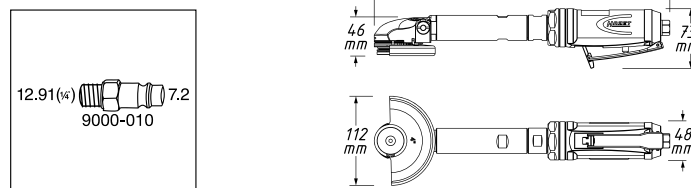



9033 Hloubková bruska



HAZET No.	l/min.	ot./min.	db(A) LpA	g	□	EAN-No. 4000896+	€
9033 P-8	113	14000	89,5	1700	-	190515	315,80
5 dělicích kotoučů 100 x 1 x 9,53 mm							
• Použití s hloubkovou bruskou HAZET 9033 P-8							
• Normy: EN 12413 a OSA							
• Vhodné pro nerezovou ocel							
9033 P-08/5	-	-	-	-	5	201549	18,10
25 dělicích kotoučů 100 x 1 x 9,53 mm							
• Použití s hloubkovou bruskou HAZET 9033 P-8							
• Normy: EN 12413 a OSA							
• Vhodné pro nerezovou ocel							
9033 P-08/25	-	-	-	-	25	201402	68,55



9033 Rozbrušovací pila

• Obrábění obrobků ve stísněných podmínkách



- Pro rozbrušovací kotouče 76 x 2,1 x 10 mm
- Upínání kotouče: 10 mm
- Plynulá regulace otáček na spodní straně přístroje
- Směr chodu (pravý/levý chod) volitelný na horní straně přístroje k řízení úletu jisker a zlepšení ergonomické pracovní polohy
- Vč. 1 rozbrušovacího kotouče
- Vzduchová přípojka vstup: Vnitřní závit 12,91 mm (1/4")
- Spojovací konektor: jmenovitá velikost 7,2 (včetně)
- Průměr hadice (doporučeno): 10 mm
- Pracovní tlak [bar]: 6,3
- Hladina akustického výkonu (při provozním tlaku): 88 db(A) Lp W
- Vibrační zrychlení: 1,80 m/s²
- Výkon W: 522 watt
- Rukojeť s izolací vůči chladu



YouTube Clip

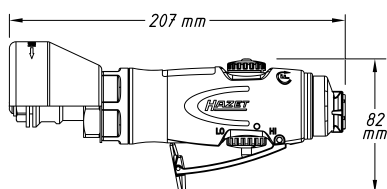

HAZET No.	l/min.	ot./min.	db(A) LpA	g	□	EAN-No. 4000896+	€
9033-10	114	2000-18000	88	900	-	196371	169,20
Sada rozbrušovacích kotoučů							
• 5 kusů v sadě							
• 76 x 2,1 x 10,0 mm							
• Normy: EN12413 a OSA							
• Vhodné i pro nerezovou ocel							
• Maximální otáčky 20100 1/min.							
• Maximální řezná rychlost 80 m/s							
9033-010/5	-	-	-	-	5	199969	28,10





9033 Sada kartáčové brusky

- Šetrné, efektivní čištění povrchů
- Rychloupínací systém Roloc® umožňuje rychlou a snadnou výměnu plastového kartáče bez dodatečného nářadí

(E)

• Použití: Odrezování, odlakování, odstraňování zbytků lepidla a těsnících hmot a rovněž k čištění kovových povrchů a svarových švů za použití různých brusných médií

- Brusný talíř závit 1/4 palce – 20 UNC
- Rozměry přístroje: 112,1 x 152 x 45 mm

• Obsah:

- 1 základní přístroj včetně vsuvky vzduchové přípojky
- 1 kartáčový brusný talíř systém Roloc® (Ø 50 mm)
- 4 porézní kotouče fialové (tvrdé)
- 4 porézni kotouče černé (měkké)
- 2 kartáčové brusky vysoce výkonné kotouč fialový (zrnitost 36)
- 2 štětinové brusky vysoce výkonné kotouč zelený (zrnitost 50)
- 2 štětinové brusky vysoce výkonné kotouč bílý (zrnitost 120)
- 1 montážní klíč

- Vzduchová přípojka vstup: Vnitřní závit 12,91 mm (1/4")
- Spojovací konektor: jmenovitá velikost 7,2 (včetně)
- Průměr hadice (doporučeno): 10 mm
- Pracovní tlak [bar]: 6,3
- Hladina akustického výkonu (při provozním tlaku): 86 db(A) Lp W
- Vibrační zrychlení: 3,11 m/s²
- Výkon W: 224 watt
- Rukojeť s izolací vůči chladu



YouTube Clip

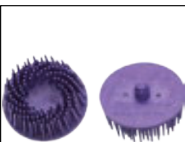
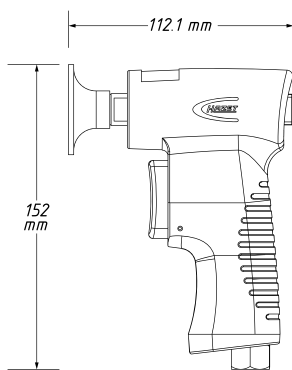

9033 Sada kartáčové brusky

(E)

HAZET No.	l/min.	ot./min.	db (A) LpA	g	EAN-No. 4000896+	€	
9033-11/17	79	15000	75	540	17	222575	211,70

Kotouč kartáčové brusky

K adaptaci brusných prostředků jako eliminátorových a štětinových kotoučů s rychloupínacím systémem Roloc™

- Rychloupínací systém Roloc® k rychlé montáži bez nářadí
- Průměr: 50 mm
- Závit: 1/4" – 20 UNC

9033-11-015	-	-	-	-	-	222841	13,80
-------------	---	---	---	---	---	--------	-------

Sada porézních kotoučů, 4dílná

Ideální k opracování zatuhlých povrchů materiálů jako např. pro nerez, železný kov, nezelezný kov, hliník nebo pro materiály jako plechy, trubky, svary

- Tvrdá varianta
- Hodí se k odrezování, odlakování, čištění svarů, odstraňování silných povrchových nečistot a vrstev

- Použití na větších plochách
- Vysoká pevnost hran
- Dlouhá životnost
- Sada obsahující 4 kotouče
- Vytužená konstrukce Clean + Strip
- Tuhé rouno z nylonových vláken
- Konstrukce z rouna z tuhých vláken
- Rychloupínací systém Roloc®
- Průměr: 50,8 mm
- Doporučené ot./min.: 8000 – 10000
- Max. ot./min.: 18000

9033-11-020/4	-	-	-	-	-	222834	22,45
---------------	---	---	---	---	---	--------	-------

Sada porézních kotoučů, 4dílná

Ideální k opracování zatuhlých povrchů

- Měkká varianta
- Pružný hrubý čistící kotouč pro univerzální aplikace
- Čištění k použití na větších plochách

- Sada obsahující 4 kotouče
- Vytužená konstrukce Clean + Strip
- Tuhé rouno z nylonových vláken
- Otevřená struktura rouna
- Rychloupínací systém Roloc®
- Průměr: 50,8 mm
- Doporučené ot./min.: 8000 – 10000
- Max. ot./min.: 18000

9033-11-030/4	-	-	-	-	-	222728	20,05
---------------	---	---	---	---	---	--------	-------

Náhradní sada pro kartáčovou brusku, fialová, 2dílná

Ideální pro čistící a lehké odhrotovací aplikace

- Umožňuje konstantní pracovní výsledky a čistící účinek během celé životnosti díky práci bez přitlaku
- Rychloupínací systém Roloc® umožňuje rychlou a snadnou výměnu plastového kartáče bez dodatečného nářadí

- Kotouč lze uvolnit a připevnit snadným otočením opěrného talíře
- S keramickým jádrem přesazený celoplastový kartáč
- Přizpůsobí se obrysům a tvarům obrobku
- Délka štětin: cca 16 mm
- Max. ot./min.: 25000
- Průměr: 50 mm
- Zrnitost: 36

9033-11-036/2	-	-	-	-	-	222872	38,05
---------------	---	---	---	---	---	--------	-------

Náhradní sada pro kartáčovou brusku, zelená, 2dílná

Ideální pro čistící a lehké odhrotovací aplikace

- Umožňuje konstantní pracovní výsledky a čistící účinek během celé životnosti díky práci bez přitlaku
- Rychloupínací systém Roloc® umožňuje rychlou a snadnou výměnu plastového kartáče bez dodatečného nářadí

- Kotouč lze uvolnit a připevnit snadným otočením opěrného talíře
- S keramickým jádrem přesazený celoplastový kartáč
- Přizpůsobí se obrysům a tvarům obrobku
- Délka štětin: cca 16 mm
- Max. ot./min.: 25000
- Průměr: 50 mm
- Zrnitost: 50

9033-11-050/2	-	-	-	-	-	222865	29,55
---------------	---	---	---	---	---	--------	-------



Pneumatické nářadí / stroje

Vrtačky a brusky



9033 Sada kartáčové brusky



HAZET No.	l/min.	ot./min.	db(A) LpA	g	EAN-No. 4000896+	€
9033-11-0120/2	-	-	-	-	222858	39,95

Náhradní sada pro kartáčovou brusku, bílá, 2dílná
 Ideální pro čisticí a lehké odhroťovací aplikace

- Umožňuje konstantní pracovní výsledky a čisticí účinek během celé životnosti díky práci bez přitlaku
- Rychloupínací systém Roloc® umožňuje rychlou a snadnou výměnu plastového kartáče bez dodatečného nářadí
- Kotouč lze uvolnit a připevnit snadným otočením opěrného talíře
- S keramickým jádrem přesazený celoplastový kartáč
- Přizpůsobí se obrysům a tvarům obrobku
- Délka štětín: cca 16 mm
- Max. ot./min.: 25000
- Průměr: 50 mm
- Zrnatost: 120

9033 Úhlová minibruska

• Vysoce zatížitelná multiložisková převodovka s 2,5násobně delší životností v porovnání s převodovkami běžnými na trhu

- Použití: Příruční a lehký přístroj pro práce ve zúžených prostorech
- Pro brusné kotouče: 50–59 mm
- Pro tloušťku brusného kotouče: 1–4 mm
- Nastavitelný ochranný kryt
- Závit vřeten: 3/8 palce UNF
- Odvětrání přes rukojeť směrem dolů
- Vzduchová přípojka vstup: Vnitřní závit 12,91 mm (1/4")
- Spojovací konektor: jmenovitá velikost 7,2 (včetně)
- Průměr hadice (doporučeno): 10 mm
- Pracovní tlak [bar]: 6,3
- Hladina akustického výkonu (při provozním tlaku): 96,8 db(A) Lp W
- Vibrační zrychlení: 1,90 m/s²
- Výkon W: 224 watt
- Rukojeť s izolací vůči chladu



YouTube Clip

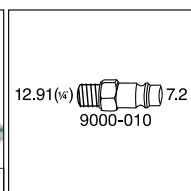
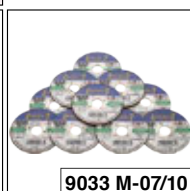
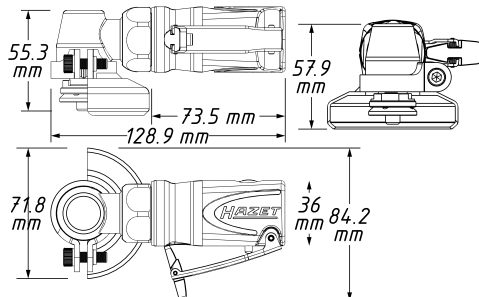

HAZET No.	l/min.	ot./min.	db(A) LpA	g	EAN-No. 4000896+	€
9033 M-7	84	18000	85,8	530	227242	148,20
• 10 dělicích kotoučů 50 x 1 x 10 mm						
• Pro ocel a nerezovou ocel						
• Maximální rychlost řezu 100 m/s						
9033 M-07/10	-	-	-	-	10 229680	24,15

9033 Minileštička

- Vysoce zatížitelná multiložisková převodovka s 2,5násobně delší životností v porovnání s převodovkami běžnými na trhu
- Optimalizované pro Spot Repair

- Použití: Pro obtížně přístupná místa a opravné práce
- Extrémně lehký, příruční přístroj
- Brusný talíř Ø: 50 mm
- Brusný talíř závit: 3/8 palce UNF
- Odvětrání přes rukojeť směrem dolů
- Vzduchová přípojka vstup: Vnitřní závit 12,91 mm (1/4")
- Spojovací konektor: jmenovitá velikost 7,2 (včetně)
- Průměr hadice (doporučeno): 10 mm
- Pracovní tlak [bar]: 6,3
- Hladina akustického výkonu (při provozním tlaku): 94,4 db(A) Lp W
- Vibrační zrychlení: 1,90 m/s²
- Výkon W: 224 watt
- Rukojeť s izolací vůči chladu



YouTube Clip

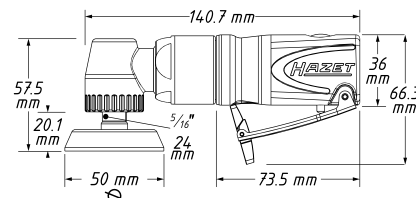

9033-5-01/10	9033-5-02/10	9033-5-03/10
9033-5-08/10	9033 M-9-010	9033 M-9-011
9033 M-9-01	12.91(1/4) 9000-010 7.2	

HAZET No.	l/min.	ot./min.	db(A) LpA	g	EAN-No. 4000896+	€
9033 M-9	84	4500	83,6	600	227235	169,40
• 10 kusů náhradních brusných polštářků, zrnatost 320, průměr 50 mm					160525	7,20
9033-5-01/10	-	-	-	10	160525	7,20
• 10 kusů náhradních brusných polštářků, zrnatost 400, průměr 50 mm					160730	7,20
9033-5-02/10	-	-	-	7	160730	7,20
• 10 kusů náhradních brusných polštářků, zrnatost 600, průměr 50 mm					160747	7,20
9033-5-03/10	-	-	-	18	160747	7,20
• 10 kusů náhradních brusných polštářků, zrnatost 800, průměr 75 mm					228317	7,20
9033-5-08/10	-	-	-	-	228317	7,20
• Náhradní lešticí talíř, průměr 50 mm					228362	17,95
9033 M-9-01	-	-	-	-	228362	17,95
• 5 kusů náhradních brusných polštářků, plochých, průměr 50 mm					228324	26,40
9033 M-9-010	-	-	-	-	228324	26,40
• 5 kusů náhradních brusných polštářků, vypouklých, průměr 50 mm					228331	26,40
9033 M-9-011	-	-	-	-	228331	26,40



9033 Taliřová minibruska · zahnutá

- **Vysoce zatížitelná multiložisková převodovka s 2,5násobně delší životností v porovnání s převodovkami běžnými na trhu**
- **Optimalizované pro Spot Repair**

- Použití: K opracování povrchů také v těžko dostupných pracovních prostorech, např. k odrezování, odstranění laků, odstranění zbytků lepidel a těsnících hmot, a také k čištění / opracování povrchů, svarových švů atd. za použití různých brusných médií
- Roloc® rychlovýměnný systém: Kombinace s mnoha brusnými médii Rychlá, snadná výměna brusných prostředků bez nářadí
- Brusný taliř Ø: 50 mm
- Brusný taliř závit: ¼ palce – 20 UNF
- Odvětrání přes rukojeť směrem dolů
- Vzduchová přípojka vstup: Vnitřní závit 12,91 mm (½")
- Spojovací konektor: jmenovitá různost 7,2 (včetně)
- Průměr hadice (doporučeno): 10 mm
- Pracovní tlak [bar]: 6,3
- Hladina akustického výkonu (při provozním tlaku): 95,2 db(A) Lp W
- Vibrační zrychlení: 1,80 m/s²
- Výkon W: 224 watt
- Rukojeť s izolací vůči chladu

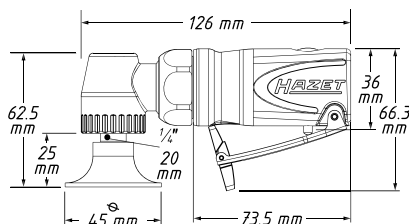

YouTube Clip



9033 Taliřová minibruska · zahnutá

HAZET No.	l/min.	ot./min.	db(A) LpA	g	EAN-No. 4000896+	€
-----------	--------	----------	-----------	---	------------------	---

• 5 kusů brusné rouno, červené , Ø 50 mm, zrnitost 150							
• Základní těleso: nylon, brusný prostředek: resin							
• Roloc® připojení							
9033-11-0150/5	-	-	-	-	5	228256	17,95

Sada porézniích kotoučů, 4dílná

Ideální k opracování zatuhlých povrchů materiálů jako např. pro nerez, železný kov, neželezný kov, hliník nebo pro materiály jako plechy, trubky, svary

- Tvrdá varianta
- Hodí se k odrezování, odlakování, čištění svarů, odstraňování silných povrchových nečistot a vrstev
- Použití na větších plochách
- Vysoká pevnost hran
- Dlouhá životnost
- Sada obsahující 4 kotouče
- Vyztužená konstrukce Clean + Strip
- Tuhé rouno z nylonových vláken
- Konstrukce z rouna z tuhých vláken
- Rychloupínací systém Roloc®
- Průměr: 50,8 mm
- Doporučené ot./min.: 8000 – 10000
- Max. ot./min.: 18000

9033-11-020/4	-	-	-	-	-	222834	22,45
----------------------	---	---	---	---	---	--------	--------------

• 5 kusů brusné rouno, modré , Ø 50 mm, zrnitost 300							
• Základní těleso: nylon, brusný prostředek: resin							
• Roloc® připojení							
9033-11-0300/5	-	-	-	-	5	228263	17,95

Sada porézniích kotoučů, 4dílná

Ideální k opracování zatuhlých povrchů

- Měkká varianta
- Pružný hrubý čistící kotouč pro univerzální aplikace
- Čištění k použití na větších plochách
- Sada obsahující 4 kotouče
- Vyztužená konstrukce Clean + Strip
- Tuhé rouno z nylonových vláken
- Otevřená struktura rouna
- Rychloupínací systém Roloc®
- Průměr: 50,8 mm
- Doporučené ot./min.: 8000 – 10000
- Max. ot./min.: 18000

9033-11-030/4	-	-	-	-	-	222728	20,05
----------------------	---	---	---	---	---	--------	--------------

Náhradní sada pro kartáčovou brusku, fialová, 2dílná

Ideální pro čistící a lehké odhroťovací aplikace

- Umožňuje konstantní pracovní výsledky a čistící účinek během celé životnosti díky práci bez přitlaku
- Rychloupínací systém Roloc® umožňuje rychlou a snadnou výměnu plastového kartáče bez dodatečného nářadí
- Kotouč lze uvolnit a připevnit snadným otočením opěrného taliře
- S keramickým jádrem přesazený celoplastový kartáč
- Přizpůsobí se obrysům a tvarům obrobku
- Délka štětin: cca 16 mm
- Max. ot./min.: 25000
- Průměr: 50 mm
- Zrnitost: 36

9033-11-036/2	-	-	-	-	-	222872	38,05
----------------------	---	---	---	---	---	--------	--------------

• 5 kusů brusné rouno, hnědé , Ø 50 mm, zrnitost 80							
• Základní těleso: nylon, brusný prostředek: resin							
• Roloc® připojení							
9033-11-080/5	-	-	-	-	5	228270	17,95

Náhradní sada pro kartáčovou brusku, zelená, 2dílná

Ideální pro čistící a lehké odhroťovací aplikace

- Umožňuje konstantní pracovní výsledky a čistící účinek během celé životnosti díky práci bez přitlaku
- Rychloupínací systém Roloc® umožňuje rychlou a snadnou výměnu plastového kartáče bez dodatečného nářadí
- Kotouč lze uvolnit a připevnit snadným otočením opěrného taliře
- S keramickým jádrem přesazený celoplastový kartáč
- Přizpůsobí se obrysům a tvarům obrobku
- Délka štětin: cca 16 mm
- Max. ot./min.: 25000
- Průměr: 50 mm
- Zrnitost: 50

9033-11-050/2	-	-	-	-	-	222865	29,55
----------------------	---	---	---	---	---	--------	--------------

HAZET No.	l/min.	ot./min.	db(A) LpA	g	EAN-No. 4000896+	€
-----------	--------	----------	-----------	---	------------------	---

9033 M-11	84	18000	84,2	440	-	227129	148,20
------------------	----	-------	------	-----	---	--------	---------------

- 1 kus **náhradní brusný taliř**

- Roloc® připojení s ¼ palcovým závitem UNF (vnitřní závit)

9033 M-11-015	-	-	-	-	-	228355	15,80
----------------------	---	---	---	---	---	--------	--------------



9033 Talířová minibruska · zahnutá

HAZET No.	l/min.	ot./min.	db(A) LpA	9	EAN-No. 4000896+	€	
Náhradní sada pro kartáčovou brusku, bílá, 2dílná Ideální pro čisticí a lehké odhrotovací aplikace							
<ul style="list-style-type: none"> • Umožňuje konstantní pracovní výsledky a čistící účinek během celé životnosti díky práci bez přitlaku • Rychloupínací systém Roloc® umožňuje rychlou a snadnou výměnu plastového kartáče bez dodatečného nářadí • Kotouč lze uvolnit a připevnit snadným otočením opěrného talíře • S keramickým jádrem přesazený celoplastový kartáč • Přizpůsobí se obrysům a tvarům obrobku • Délka štětin: cca 16 mm • Max. ot./min.: 25000 • Průměr: 50 mm • Zrnitost: 120 							
9033-11-0120/2	-	-	-	-	222858	39,95	
• 5 kusů brusných talířů , Ø 50 mm, zrnitost 60							
• Základní těleso: papír, brusný prostředek: resin, kyselina stearová - sůl kovu							
• Roloc® připojení							
9033-11-S 060	-	-	-	-	5	228287	10,50
• 5 kusů brusných talířů , Ø 50 mm, zrnitost 80							
• Základní těleso: papír, brusný prostředek: resin, kyselina stearová - sůl kovu							
• Roloc® připojení							
9033-11-S 080	-	-	-	-	5	228294	10,50
• 5 kusů brusných talířů , Ø 50 mm, zrnitost 120							
• Základní těleso: papír, brusný prostředek: resin, kyselina stearová - sůl kovu							
• Roloc® připojení							
9033-11-S 120	-	-	-	-	5	228300	10,50

9032 Sada tvrdokovových frézovacích kolíků 3 mm

Made in Germany

• **Dlouhá životnost a dobrý řezný výkon při použití na nejrůznějších materiálech**

- Vhodné pro ručně vedené nebo stacionární hnací stroje
- Podle DIN 8032
- Tip pro uživatele od HAZET:
- Používejte co nejvyšší otáčky
- Kontaktní plocha mezi frézovacím kolíkem a obrobkem by nikdy neměla překročit 30 % celého obvodu frézovacího kolíku
- Frézovací kolíky s 3 mm dřikem
- Pracovní délka: cca 13 mm (válcový a kuželový tvar)
- Sada s 5 různými frézami ve válcovém, kuželovitém a kulovém tvaru
- Průměr hlavy (válcový tvar): 3 / 6 mm
- Průměr hlavy (kulový tvar): cca 3 / 6 mm



YouTube Clip



9032 Sada tvrdokovových frézovacích kolíků 3 mm

9032-03 KE	9032-03 KU 6	9032-03 ZY 6
9032-03 KU 3	9032-03 ZY 3	

HAZET No.		EAN-No. 4000896+	€
• Sada s 5 různými frézami ve válcovém, kuželovitém a kulovém tvaru			
• Průměr hlavy (válcový tvar): 3 / 6 mm			
• Průměr hlavy (kulový tvar): cca 3 / 6 mm			
9032-03/5	5	222483	100,60
• Frézovací kolík, kuželový			
9032-03 KE	-	226771	30,75
• Frézovací kolík, kulový, Ø 3 mm			
9032-03 KU 3	-	226405	21,20
• Frézovací kolík, kulový, Ø 6 mm			
9032-03 KU 6	-	226764	26,50
• Frézovací kolík, válcový, Ø 3 mm			
9032-03 ZY 3	-	226788	21,20
• Frézovací kolík, válcový, Ø 6 mm			
9032-03 ZY 6	-	226795	26,50

9032 Sada tvrdokovových frézovacích kolíků 6 mm

Made in Germany

• **Dlouhá životnost a dobrý řezný výkon při použití na nejrůznějších materiálech**

- Vhodné pro ručně vedené nebo stacionární hnací stroje
- Podle DIN 8032
- Tip pro uživatele od HAZET:
- Používejte co nejvyšší otáčky
- Kontaktní plocha mezi frézovacím kolíkem a obrobkem by nikdy neměla překročit 30 % celého obvodu frézovacího kolíku
- Frézovací kolík s 6 mm dřikem
- Pracovní délka: cca 19 mm (válcový a kuželový tvar)
- Sada s 3 různými frézami ve válcovém, kuželovitém a kulovém tvaru
- Průměr hlavy (válcový tvar): 10 mm
- Průměr hlavy (kulový tvar): cca 9 mm

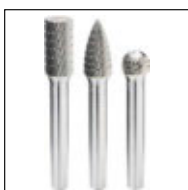

YouTube Clip



9032-06 KE	9032-06 KU	9032-06 ZY
------------	------------	------------

HAZET No.		EAN-No. 4000896+	€
• Sada s 3 různými frézami ve válcovém, kuželovitém a kulovém tvaru			
• Průměr hlavy (válcový tvar): 10 mm			
• Průměr hlavy (kulový tvar): cca 9 mm			
9032-06/3	3	222667	81,55
• Frézovací kolík, kuželový			
9032-06 KE	-	226825	30,75
• Frézovací kolík, kulový, Ø 9 mm			
9032-06 KU	-	226801	30,75
• Frézovací kolík, válcový, Ø 10 mm			
9032-06 ZY	-	226818	39,20



9034 P Přímochařá pila

• **Vyšší výkon při současném snížení hmotnosti, spotřeby vzduchu, hlučnosti a vibrací**

- Směr výstupu vzduchu nastavitelný
- Vhodné pro řezání malých poloměrů
- Řezný výkon hliník: 4 mm
- Řezný výkon ocelový plech: 3 mm
- Zdvihy / min.: 9500
- Díky uchycení listů pilníků (součástí dodávky) se zvláště hodí k čištění šachet snímačů atd.

Obsah:

- 1 přímochařá pila
- 3 pilové listy, po 18 / 24 / 32 zubech (celková délka: 93 mm)
- 1 reciproční pilový list, 18 zubů (celková délka: 153 mm)
- 5 pilníků (celková délka: ~135 mm)
- 1 klíč s vnitřním šestihranem (v rukojeti)

- Vzduchová přípojka vstup: Vnitřní závit 12,91 mm (1/4")
- Spojovací konektor: jmenovitá velikost 7,2 (včetně)
- Průměr hadice (doporučeno): 10 mm
- Pracovní tlak [bar]: 6,3
- Hladina akustického výkonu (při provozním tlaku): 97,7 db(A) Lp W
- Vibrační zrychlení: 6,13 m/s²
- Zdvih pily: 10 mm



YouTube Clip

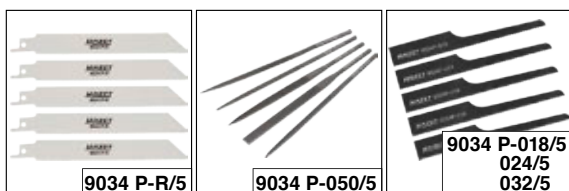
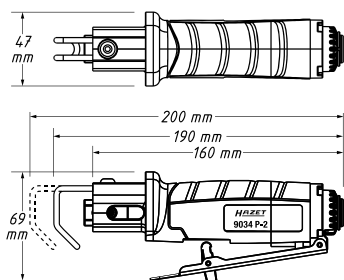

HAZET No.	l / mm	l/min.	db (A) LpA	g	EAN-No. 4000896+	€
9034 P-2	160	99	86,7	400	218288	228,90

Reciproční listy pro přímochařou pilu

vhodné pro přímochařou pilu 9034 P-2

- Obsah balení 5 kusů
- Šikmé zvlněné ozubení, 18 zubů
- Pro všechny kovy včetně nezelezného potrubí, plechy a nerezovou ocel, tloušťka materiálu 1,5 – 3 mm
- Celková délka: 153 mm
- Bi-metal

9034 P-R/5	153	-	-	175	218318	30,45
------------	-----	---	---	-----	--------	-------

Sada pilníků

vhodné pro přímochařou pilu 9034 P-2

- Obsah balení 5 kusů
- Obsah:
 - 1 kulatý pilník
 - 1 trojúhelníkový pilník
 - 1 půlkulatý pilník
 - 1 plochý pilník
 - 1 hranatý pilník

- Hodí se pro čtené materiály
- Celková délka: cca 135 mm

9034 P-050/5	135	-	-	115	218349	27,05
--------------	-----	---	---	-----	--------	-------

Pilové listy

vhodné pro přímochařou pilu 9034-1 · 9034 P-1 · 9034 P-2

- Obsah balení 5 kusů
- Celková délka 93 mm
- Uložení 1 x 13 mm

18 zubů

9034 P-018/5	93	-	-	-	225958	19,10
--------------	----	---	---	---	--------	-------

24 zubů

9034 P-024/5	93	-	-	-	225965	19,10
--------------	----	---	---	---	--------	-------

32 zubů

9034 P-032/5	93	-	-	-	225989	19,10
--------------	----	---	---	---	--------	-------

9035 Otloukač rzi

• **Ve tvaru pistole**



- Nastavitelný kryt jehel umožňuje maximální využití jehel
- 2dílný plášť usnadňuje údržbu
- 19 jehel, Ø 3 mm
- 3200 rázů/min
- Vzduchová přípojka vstup: Vnitřní závit 12,91 mm (1/4")
- Spojovací konektor: jmenovitá velikost 7,2 (včetně)
- Pracovní tlak [bar]: 6,3
- Rukojeť s izolací vůči chladu



360°

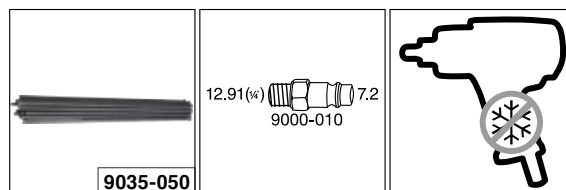
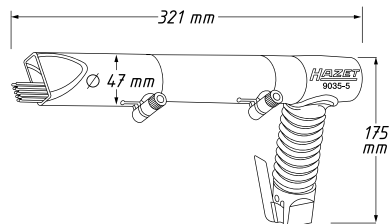

HAZET No.	l/min.	db (A) LpA	g	EAN-No. 4000896+	€
9035-5	170	97	2600	132355	333,30
Náhradní jehly vhodné pro otloukač rzi 9035-5 19 jehel, Ø 3 mm					
9035-050	-	-	202	139385	24,80

9035 Otloukač rzi

• **Extrémně úzký / krátký tvar kolíku a volné jehly umožňují dosáhnout také do točících oblastí.**

- 28 mm úzká rukojeť zaručuje skvělé uchopení
- 235,6 mm krátký přístroj dosáhne i do úzkých konstrukčních prostor
- 13 tenké jehly (Ø 1,3 mm) zajistí zpracování bez poškození a také velmi jemnou strukturu povrchu
- Silný a efektivní nástroj
- Jen 480 g – velmi lehký a dobře ovladatelný
- 3000 rázů/min
- Bezpečnostní uvolňovací páka
- Plynule nastavitelný výkon
- Vzduchová přípojka vstup: Vnitřní závit 12,91 mm (1/4")
- Spojovací konektor: jmenovitá velikost 7,2 (včetně)
- Pracovní tlak [bar]: 6,3
- Hladina akustického výkonu (při provozním tlaku): 98,8 db(A) Lp W
- Rukojeť s izolací vůči chladu

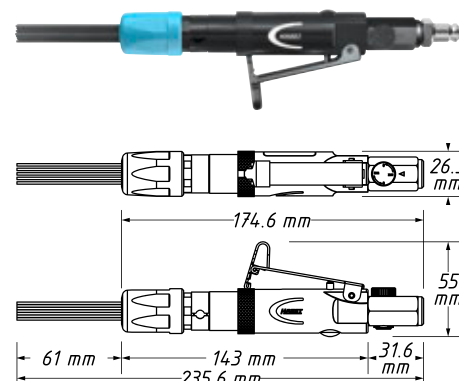



Pneumatické nářadí / stroje

Vrtačky a brusky



9035 Otloukač rzi

HAZET No.	l mm	l/min.	db (A) LpA	g	EAN-No. 4000896+	€
9035 M-5	235,6	48,1	87,9	480	232284	241,50
Náhradní jehly vhodné pro otloukač rzi 9035 M-5 13 jehel, Ø 1,3 mm						
9035 M-050	-	-	-	-	233205	10,20

9035 H Sada sekacího kladiva

- Počet úderů nastavitelný v 9 stupních až 2600 úderů/min
- Uchycení sekáče: Ø 10 mm
- Délka spínacího uchycení: 73 mm
- Plastový kufr
- Vzduchová přípojka vstup: Vnitřní závit 12,91 mm (1/4")
- Spojovací konektor: jmenovitá velikost 7,2 (včetně)
- Pracovní tlak [bar]: 6,3
- Rukojeť s izolací vůči chladu



YouTube Clip

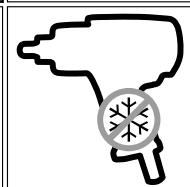
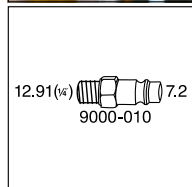
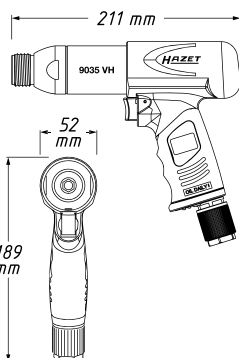
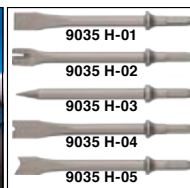
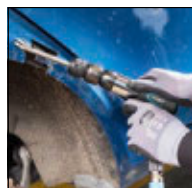

HAZET No.	g	EAN-No. 4000896+	€
• Sada sekacího kladiva			
• Spotřeba vzduchu: 57 – 594 l/min			
• Hladina akustického tlaku: 92 – 105 dB(A) Lp A			
9035 H/6	2500	6	214655 238,90
• Kombinované základní zařízení s funkcí vibrací a kladiva			
• Plastový kufr			
• Spotřeba vzduchu: 57 – 594 l/min			
• Hladina akustického tlaku: 92 – 105 dB(A) Lp A			
9035 VH	2500	-	214020 208,20
• Rychloupínací sklíčidlo			
• Pro 9035 VH · 9035 H/6 · 9035 V/5			
9035 VH-01	-	-	214242 26,30
• Sada náhradních sekáčů k 9035 H/6			
• Obsah: 9035 H-01 · 02 · 03 · 04 · 05			
9035 H/5	-	5	214006 51,55
• Plochý sekáč			
9035 H-01	-	-	214136 13,20
• Sekáč na plech			
9035 H-02	-	-	213924 13,20
• Špičatý sekáč			
9035 H-03	-	-	214198 13,20
• Sekáč nýtů			
9035 H-04	-	-	214143 13,20
• Křivkový sekáč			
9035 H-05	-	-	214525 13,20

9035 V Sada vibračního sekáče

- Počet úderů nastavitelný v 9 stupních až 2600 úderů/min
- Uchycení sekáče: Ø 10 mm
- Délka spínacího uchycení: 73 mm
- Plastový kufr
- Vzduchová přípojka vstup: Vnitřní závit 12,91 mm (1/4")
- Spojovací konektor: jmenovitá velikost 7,2 (včetně)
- Pracovní tlak [bar]: 6,3
- Rukojeť s izolací vůči chladu



YouTube Clip

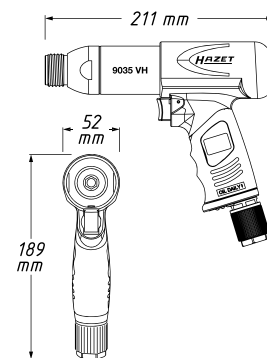
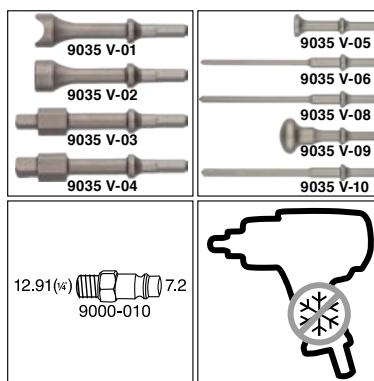

HAZET No.	g	EAN-No. 4000896+	€
• Sada vibračního sekáče			
• Spotřeba vzduchu: 57 – 594 l/min			
• Hladina akustického tlaku: 92 – 105 dB(A) Lp A			
9035 V/5	2500	5	213368 294,80
• Kombinované základní zařízení s funkcí vibrací a kladiva			
• Plastový kufr			
• Spotřeba vzduchu: 57 – 594 l/min			
• Hladina akustického tlaku: 92 – 105 dB(A) Lp A			
9035 VH	2500	-	214020 208,20
• Rychloupínací sklíčidlo			
• Pro 9035 VH · 9035 H/6 · 9035 V/5			
9035 VH-01	-	-	214242 26,30
• Sada náhradních sekáčů k 9035 V/5			
• Obsah: 9035 V-01 · 02 · 03 · 04			
9035 V/4	-	4	214013 104,10
• Půlkruhový vibrační sekáč			
9035 V-01	-	-	214181 26,30
• Kruhový vibrační sekáč			
9035 V-02	-	-	214174 26,30
• Vibrační sekáč ■ 10 = 3/8" / ● ≤ 19 mm			
9035 V-03	-	-	214167 30,75
• Vibrační sekáč ■ 12,5 = 1/2" / ● ≤ 19 mm			
9035 V-04	-	-	214150 30,75
• Vibrační sekáč, plochý			
9035 V-05	-	-	227266 18,05
• Vibrační vytloukač závlaček 6 mm			
9035 V-06	-	-	227259 14,85
• Vibrační vytloukač závlaček 8 mm			
9035 V-08	-	-	227297 14,85
• Vibrační sekáč vypouklý			
9035 V-09	-	-	227280 52,95
• Vibrační vytloukač závlaček 10 mm			
9035 V-010	-	-	227273 14,85



9036 Prostřihávač plechu

Plynulá regulace rychlosti regulátorem otáček na hřbetu rukojeti



- Použití: Ideální pro řezání s malým rádiusem (**min. 4,5 mm**). Vhodné také pro stříhání plastů
- Řezný výkon: ocel 1,2 mm / hliník 1,6 mm
- Šířka řezu: 4,5 mm
- Vzduchová přípojka vstup: Vnitřní závit 12,91 mm (1/4")
- Spojovací konektor: jmenovitá velikost 7,2 (včetně)
- Průměr hadice (doporučeno): 10 mm
- Pracovní tlak [bar]: 6,3
- Hladina akustického výkonu (při provozním tlaku): 87 db(A) Lp W
- Vibrační zrychlení: 1,90 m/s²
- Výkon W: 370 watt
- Rukojeť s izolací vůči chladu

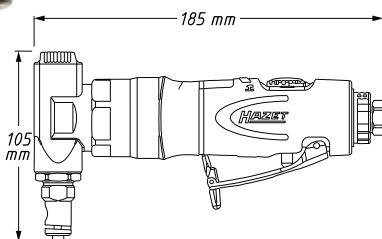
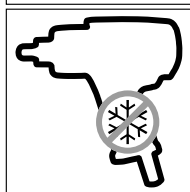
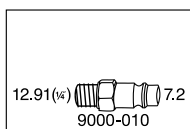

HAZET No.	l/min.	ot./min.	db (A) LpA	g	EAN-No. 4000896+	€
9036 N-1	104	2600	80	1000	209668	149,-

9036 Nůžky na plech

Výkonný břit pro maximální řezný výkon: ocel 1,2 mm / hliník 1,6 mm



- Použití: Pro vysoce přesné řezání všech hliníkových a ocelových plechů
- Ideální pro rovné řezy
- Vhodný i pro konturové řezy
- Plynulá regulace rychlosti regulátorem otáček na hřbetu rukojeti
- S tlumením vibrací
- Šířka řezu: 4,5 mm
- Vzduchová přípojka vstup: Vnitřní závit 12,91 mm (1/4")
- Spojovací konektor: jmenovitá velikost 7,2 (včetně)
- Průměr hadice (doporučeno): 10 mm
- Pracovní tlak [bar]: 6,3
- Hladina akustického výkonu (při provozním tlaku): 86 db(A) Lp W
- Vibrační zrychlení: 1,60 m/s²
- Výkon W: 370 watt
- Rukojeť s izolací vůči chladu

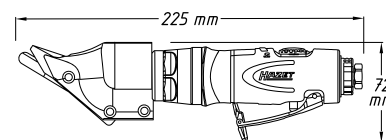
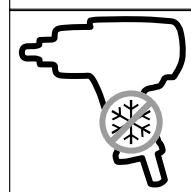
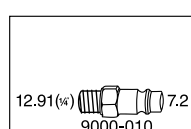

HAZET No.	l/min.	ot./min.	db (A) LpA	g	EAN-No. 4000896+	€
9036 N-5	104	2600	80	1000	209651	147,-

Pistole na slepé nýty

9037 Pistole na slepé nýty

**Pneumatická / hydraulická
Vhodná pro nerezové nýty do 6,4 mm**

- Profesionální nýtování při trvalém použití s ocelovými, nerezovými, hliníkovými a měděnými nýty do velikosti 6,4 mm
- Možné velikosti nýtů: 3,0 · 3,2 · 4,0 · 4,8 · 5,0 · 6,0 a 6,4 mm
- 5 hubic (jedna předmontovaná)
- Velikost závitů hubic: M 10 x 1,25
- Délka zdvihu: 15,8 mm
- Vysoká tažná síla: 14700 N
- Obzvlášť tichá
- Otočný kloub pro flexibilní použití
- Šablona nýtu a nátrubku na spodní straně nýtovací pistole
- Uložení různých nátrubků na spodní straně nýtovací pistole
- Jednoduché doplnění oleje díky speciálnímu designu nýtovací pistole
- Včetně údržbové sady ke kontrole oleje (podpora oleje vytvoření tlaku)
- Spotřeba vzduchu: 2,64 l/zdvih
- Vzduchová přípojka vstup: Vnitřní závit 12,91 mm (1/4")
- Spojovací konektor: jmenovitá velikost 7,2 (včetně)
- Průměr hadice (doporučeno): 10 mm
- Pracovní tlak [bar]: 6,3
- Rukojeť s izolací vůči chladu

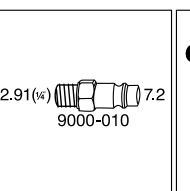
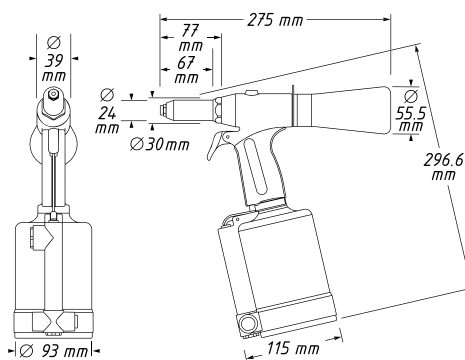

HAZET No.	g	EAN-No. 4000896+	€
9037 N-2	2110	205578	550,-



Pneumatické nářadí / stroje

Vyfukovací nářadí



9037 Pistole na slepé nýty

• Pneumatická / hydraulická
Pro slepé nýty

- Možné velikosti nýtů: 2,4–3,0–3,2–4,0–4,8 mm
- Hliníkové nýty: 2,4–4,8 mm
- Ocelové nýty: 2,4–4,8 mm
- Nerezové nýty: 2,4–3,2 mm
- 4 hubic (jedna předmontovaná)
- Robustní kovové tělo
- Tažná síla: 8700 N
- Zástrčka spojky s otočným kloubem pro flexibilní použití
- Spotřeba vzduchu: 1 l/zdvih
- Vzduchová přípojka vstup: Vnitřní závit 12,91 mm (1/4")
- Spojovací konektor: jmenovitá velikost 7,2 (včetně)
- Pracovní tlak [bar]: 6,3

360°

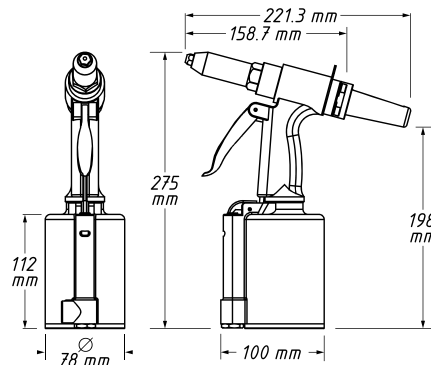
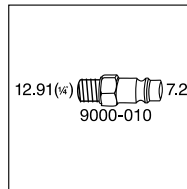
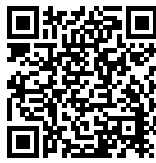

Ⓔ

HAZET No.	db (A) LpA	g	EAN-No. 4000896+	€
9037 SPC	73	1500	150168	169,90

Vyfukovací nářadí

9040 Ofukovací pistole 100 mm

• Standardní tryska
• Zahnutá trubka

- Použití: Rychlé odstranění špon a jiných cizích těles, zvláště na špatně přístupných místech
- Použití u strojů, v dílnách, při zpracování dřeva, při údržbářských pracích a v domácnosti
- Ø trubky: 8 mm
- Max. provozní tlak: 16 barů
- Rukojeť, spoušť a ventil z acetátového plastu
- Těsnění a O-kroužky z nitrilu
- Ofukovací trubka a hřídel z oceli
- Pružiny z tvrzené pružinové oceli
- 2003/10/CE Max 85 dB
- OSHA 1910.95 (b) Max 90 dB 8 hr
- Vzduchová přípojka vstup: Vnitřní závit 12,91 mm (1/4")
- Spojovací konektor: jmenovitá velikost 7,2 (včetně)
- Pracovní tlak [bar]: 6
- Teplotní rozsah: -10°C – 80°C

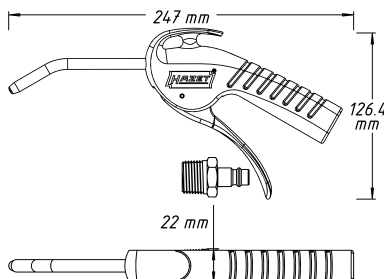

YouTube Clip

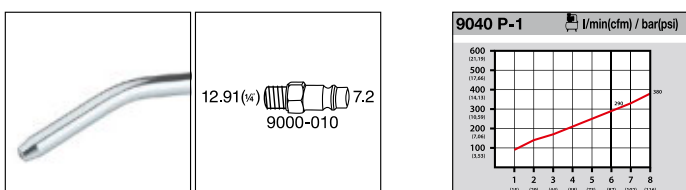

HAZET No.	l/min.	db (A) LpA	g	EAN-No. 4000896+	€
9040 P-1	247	84	105	209545	16,95

9040 Ofukovací pistole 300 mm

• Dlouhá tryska
• Rovná trubka

- Použití: Rychlé odstranění špon a jiných cizích těles, zvláště na špatně přístupných místech
- Použití u strojů, v dílnách, při zpracování dřeva, při údržbářských pracích a v domácnosti
- Ø trubky: 8 mm
- Provozní tlak max: 16 bar
- Rukojeť, spoušť a ventil z acetátového plastu
- Těsnění a O-kroužky z nitrilu
- Ofukovací trubka a hřídel z oceli
- Délka ofukovací trubky ~ 280 mm
- Pružiny z tvrzené pružinové oceli
- 2003/10/CE Max 85 dB
- OSHA 1910.95 (b) Max 90 dB 8 hr
- Vzduchová přípojka vstup: Vnitřní závit 12,91 mm (1/4")
- Spojovací konektor: jmenovitá velikost 7,2 (včetně)
- Průměr hadice (doporučeno): 10 mm
- Pracovní tlak [bar]: 6
- Teplotní rozsah: -10°C – 80°C

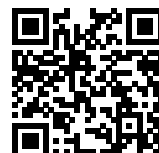
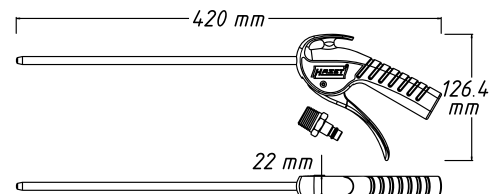

YouTube Clip

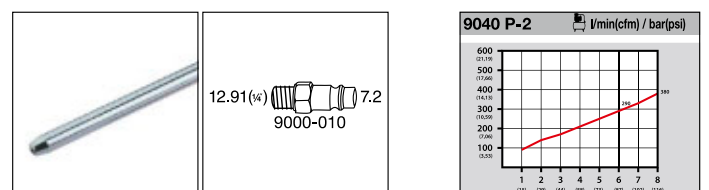

HAZET No.	l/min.	db (A) LpA	g	EAN-No. 4000896+	€
9040 P-2	420	84	190	209552	28,85



9040 Ofukovací pistole 100 mm · tichá · se zahnutou trubicou

- S extrémně sníženou hlučností
- Silná ofukovací síla
- Bez blokování

- Použití: Rychlé odstranění špon a jiných cizích těles, zvláště na špatně přístupných místech
- Použití u strojů, v dílnách, při zpracování dřeva, při údržbářských pracích a v domácnosti
- Ø trubky: 8 mm
- Max. provozní tlak: 12 barů
- Rukojeť, spoušť a ventil z acetátového plastu
- Těsnění a O-kroužky z nitrilu
- Ofukovací trubka a hřídel z oceli
- Pružiny z tvrzené pružinové oceli
- 2003/10/CE Max 85 dB
- OSHA 1910.95 (b) Max 90 dB 8 hr
- OSHA STD 1-13.1, Max 30 PSI při zablokování
- Vzduchová přípojka vstup: Vnitřní závit 12,91 mm (1/4")
- Spojovací konektor: jmenovitá velikost 7,2 (včetně)
- Pracovní tlak [bar]: 6
- Teplotní rozsah: -10°C – 80°C

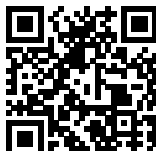

YouTube Clip

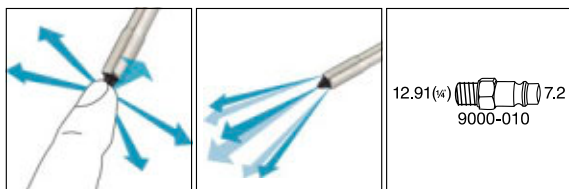
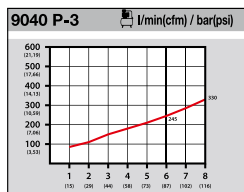
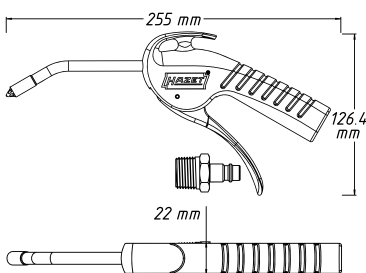

12.91 (1/4) 7.2 9000-010

HAZET No.	l mm	l/min.	db (A) LpA	g	EAN-No. 4000896+	€
9040 P-3	255	245	76,8	100	209644	28,85

9040 Ofukovací pistole 100 mm · s Venturiho trubicí a zahnutou trubicou

- 100% zvýšené množství výstupního vzduchu díky Venturiho trubicí
- Extrémní ofukovací síla
- Bez blokování

- Použití: Rychlé odstranění špon a jiných cizích těles, zvláště na špatně přístupných místech
- Použití u strojů, v dílnách, při zpracování dřeva, při údržbářských pracích a v domácnosti
- Ø trubky: 8 mm
- Max. provozní tlak: 16 barů
- Rukojeť, spoušť a ventil z acetátového plastu
- Těsnění a O-kroužky z nitrilu
- Ofukovací trubka a hřídel z eloxované oceli
- Pružiny z tvrzené pružinové oceli
- OSHA 1910.95 (b) Max 90 dB 8 hr
- OSHA STD 1-13.1, Max 30 PSI při zablokování
- Vzduchová přípojka vstup: Vnitřní závit 12,91 mm (1/4")
- Spojovací konektor: jmenovitá velikost 7,2 (včetně)
- Pracovní tlak [bar]: 6
- Teplotní rozsah: -10°C – 80°C



YouTube Clip



9040 Ofukovací pistole 100 mm · s Venturiho trubicí a zahnutou trubicou

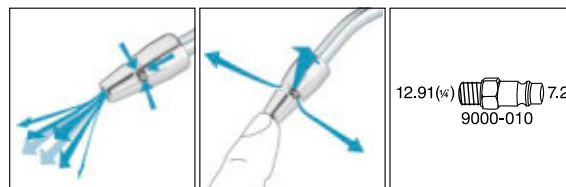
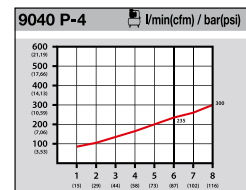
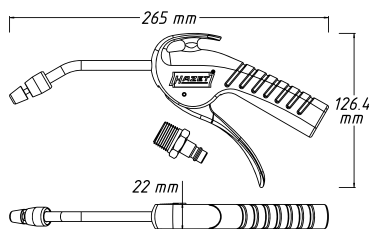

12.91 (1/4) 7.2 9000-010

HAZET No.	l mm	l/min.	db (A) LpA	g	EAN-No. 4000896+	€
9040 P-4	265	235	83,7	165	209569	28,85

9040 Ofukovací pistole · tichá s širokou plochou tryskou

- Široká plochá tryska pro plošné čištění
- Značná ofukovací síla
- Bez blokování

- Použití: Rychlé odstranění špon a jiných cizích těles, zvláště na špatně přístupných místech
- Použití u strojů, v dílnách, při zpracování dřeva, při údržbářských pracích a v domácnosti
- Max. provozní tlak: 8 barů
- Rukojeť, spoušť a ventil z acetátového plastu
- Těsnění a O-kroužky z nitrilu
- Pružiny z tvrzené pružinové oceli
- 2003/10/CE Max 85 dB
- OSHA 1910.95 (b) Max 90 dB 8 hr
- OSHA STD 1-13.1, Max 30 PSI při zablokování
- Vzduchová přípojka vstup: Vnitřní závit 12,91 mm (1/4")
- Spojovací konektor: jmenovitá velikost 7,2 (včetně)
- Pracovní tlak [bar]: 6
- Teplotní rozsah: -10°C – 80°C



YouTube Clip

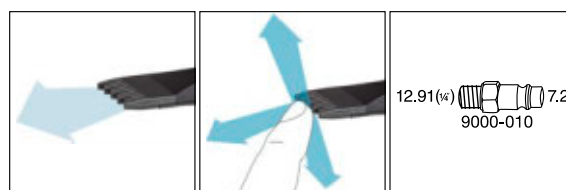
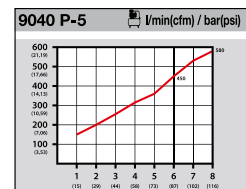
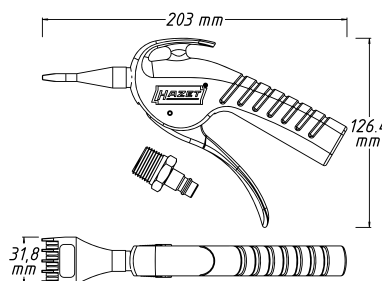

12.91 (1/4) 7.2 9000-010

HAZET No.	l mm	l/min.	db (A) LpA	g	EAN-No. 4000896+	€
9040 P-5	203	450	78	95	209576	28,85



Pneumatické nářadí / stroje

Vyfukovací nářadí



9040 Dvoucestná ofukovací pistole

• Volitelná přípojka vzduchu na hlavě nebo rukojeti



- Použití: Rychlé odstraňování třísek nebo jiných cizích předmětů
- Vyměnitelné trysky:
 - Krátká tryska pro omezené prostory
 - Dlouhá tryska (112 mm) s bezpečnostním hrotem trysky (ochrana proti poškrábání)
- Maximální tlak: 10 barů
- Regulátor tlaku
- Použití u strojů, v dílnách, při zpracování dřeva, při údržbářských pracích a v domácnosti
- Hliníkové pouzdro
- Závit trysky: 1/8 palce PF 28 (9,728 mm vnější Ø / 0,907 mm stoupání)
- Vzduchová přípojka vstup: Vnitřní závit 12,91 mm (1/4")
- Spojovací konektor: jmenovitá velikost 7,2 (včetně)
- Pracovní tlak [bar]: 6,3
- Protiskluzová rukojeť izolující proti chladu



360°

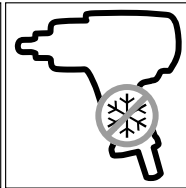
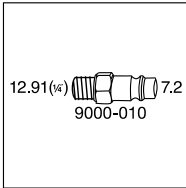

HAZET No.	l/min.	db (A) LpA	g	EAN-No. 4000896+	€
9040-4	330	86	205	176236	24,30

9040 Ofukovací tužka

• Praktické a kompaktní provedení se závěsným klipem, např. pro náprsní kapsu



- Proudění vzduchu lze nastavit přetočením
- Tryska: 3 mm Ø
- Snadné použití, připojení přímo na vzduchovou přípojku 7,2 mm
- Vstupní tlak: 12 barů
- Průtok max: 360 l/min při 6 barech
- Těsnění Perbunan (NBR)
- Kryt z duralu
- Spojovací konektor: integrovaný, jmenovitá velikost 7,2

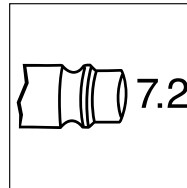

360°

HAZET No.	EAN-No. 4000896+	€
9040-3	109500	8,55



9040 LG Ofukovací pistole · dlouhá

• Vč. 90° boční trysky a Venturiho trysky



- Použití: Čištění těžko přístupných míst na strojích, vozidlech a zemědělských strojích
Speciálně se hodí k čištění sendvičových chladičů
- Izolace trysky v oblasti rukojeti proti ochlazení
- Venturiho tryska (54 mm / 35 gramů) pro zvýšení výkonu
- 90° boční tryska (32 mm / 8,4 gramů) k čištění sendvičových chladičů
- Maximální tlak: 12 barů
- Ergonomická rukojeť
- Vzduchová přípojka vstup: Vnitřní závit 12,91 mm (1/4")
- Spojovací konektor: jmenovitá velikost 7,2 (včetně)
- Průměr hadice (doporučeno): 10 mm
- Pracovní tlak [bar]: 6,3
- Rukojeť s izolací vůči chladu

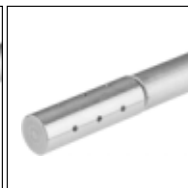

YouTube Clip

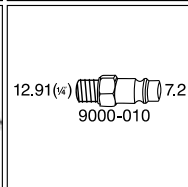
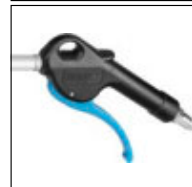

HAZET No.	l mm	l/min.	g		EAN-No. 4000896+	€
9040 Lg-3/2	1085	450	313	2	206339	85,55



Přístroje pro huštění pneumatik a měřicí přístroje

9041 Měřič tlaku v pneumatikách

- Speciální pryžové opláštění chrání manometr před lehkými nárazy
- Rukojeť s ovládací páčkou a výpustným tlačítkem (pro jednoruční obsluhu)
- Hadice s integrovanou momentovou nástrčnou spojkou
- Max. tlak: 8 barů
- V rukojeti integrované závěsné zařízení
- Měřicí rozsah manometru: 0–12 bar
Dělení: 0,1 bar
- Flexibilní hadice, délka: 400 mm
- Průměr manometru: 63 mm
- Vzduchová přípojka vstup: Vnitřní závit 12,91 mm (1/4")
- Spojovací konektor: jmenovitá velikost 7,2 (včetně)
- Pracovní tlak [bar]: 6,3



12,91 (1/4) 7,2
9000-010

HAZET No.	g	EAN-No. 4000896+	€
9041-1	411	147076	35,85

9041 Měřič tlaku v pneumatikách · digitální

- Snadná a optimální možnost odečtu i za špatných světelných poměrů
- Použití: Plnění pneumatik a kontrola tlaku vzduchu
- Speciální pryžové opláštění chrání manometr před lehkými nárazy
- Rukojeť s ovládací páčkou pro plnění a rovněž vyprazdňovací knoflík pro jednoruční obsluhu
- Hadice s integrovanou momentovou nástrčnou spojkou
- V rukojeti integrované závěsné zařízení
- Měřicí rozsah manometru: 0–12 bar, dělení: 0,01 bar
- Modré osvětlení displeje
- Flexibilní hadice, délka: 400 mm
- Průměr manometru: 63 mm
- Rozměry přístroje 262 x 105 x 40 mm
- Zobrazení přepínatelné mezi bar / PSI / kg/cm²
- Max. tlak: 12 barů
- Vlhkost vzduchu při použití: 60%
- Napájení proudem: 2 x 1,5V lithiové baterie typ AAA
- Vzduchová přípojka vstup: Vnitřní závit 12,91 mm (1/4")
- Spojovací konektor: integrovaný, jmenovitá velikost 7,2
- Teplotní rozsah: -20°C – 50°C



9041 Měřič tlaku v pneumatikách · digitální

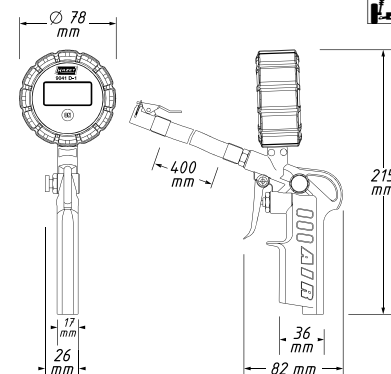

HAZET No.	g	EAN-No. 4000896+	€
9041 D-1	385	212378	86,60

9041 Měřič tlaku v pneumatikách · kalibrováný

- Cejchovaný přístroj s optimálně odečitatelným velkým manometrem
- Použití: Přesné plnění pneumatik a kontrola tlaku vzduchu
- Speciální pryžové opláštění chrání manometr před lehkými nárazy
- Rukojeť s ovládací páčkou pro plnění a vyprazdňování (jednoruční obsluha)
- Hadice s integrovanou momentovou nástrčnou spojkou
- V rukojeti integrované závěsné zařízení
- Měřicí rozsah manometru: 0–10 bar, dělení: 0,1 bar
- Flexibilní hadice, délka: 1000 mm
- Průměr manometru: 80 mm
- Rozměry přístroje 220 x 150 x 90 mm
- Max. tlak: 10 barů
- Vlhkost vzduchu při použití: 60%
- Vzduchová přípojka vstup: Vnitřní závit 12,91 mm (1/4")
- Spojovací konektor: integrovaný, jmenovitá velikost 7,2
- Teplotní rozsah: -20°C – 60°C

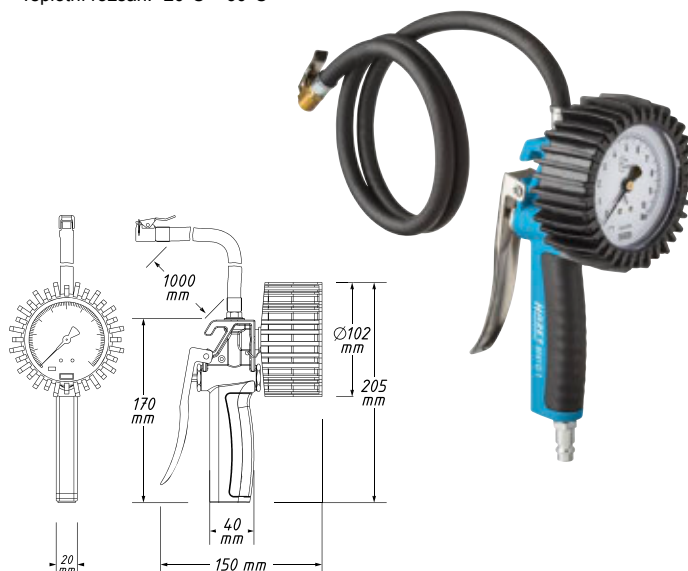

HAZET No.	g	EAN-No. 4000896+	€
9041 G-1	585	212385	86,80



Tukové lisy, stříkací pistole, sací/ofukovací pistole

9042 N Mazací lis

• **360° otočný mazací lis s kontinuální dopravou tuku a odvzdušňovacím ventilem**

- Plnění mazací kartuší, volným tukem
- Délka kovové trubky: 172 mm
- Délka nylonové hadice: 230 mm
- Objem náplně: 400 ml
- Stlačení: 40 : 1
- Připojovací závit kovové trubky / nylonové hadice: M10 x 1 (konické)
- Vzduchová přípojka vstup: Vnitřní závit 12,91 mm (1/4")
- Spojovací konektor: jmenovitá velikost 7,2 (včetně)
- Pracovní tlak [bar]: 6,3



HAZET No.	l/min.	g	EAN-No. 4000896+	€
9042 N-1	230	2000	176472	107,30

9042 Pistole na karoserie pro ochranu podvozku a utěsnění dutých prostor

- Snadná výměna trysky a hadice
- Vč. kovové sací trubky
- Průtok kapaliny optimálně pro uživatele regulovatelný spouští

- Použití: Ošetření a údržba osobních automobilů a jiných vozidel. Hodí se pro vodní nebo olejové kapaliny
- Včetně trysky a hadice pro duté prostory
- Max. provozní tlak: 16 barů
- Spotřeba vzduchu s tryskou 380 l/min při 8 bar
- Spotřeba vzduchu s tryskou 255 l/min při 6 bar
- Spotřeba vzduchu s hadicí pro duté prostory: 180 l/min při 8 bar
- Spotřeba vzduchu s hadicí pro duté prostory: 165 l/min při 6 bar
- Závit: BSP/NPT
- Hadice pro duté prostory 920 mm využitelná délka
- Rukojeť, spoušť a ventil z acetalového plastu
- Těsnění a O-kroužky z nitrilu
- Trysky z oceli / plastu
- Pružiny z tvrzené pružinové oceli
- Čistá hmotnost s tryskou 350 g
- Čistá hmotnost s hadicí pro duté prostory 338 g
- Vzduchová přípojka vstup: Vnitřní závit 12,91 mm (1/4")
- Spojovací konektor: jmenovitá velikost 7,2 (včetně)
- Pracovní tlak [bar]: 6
- Teplotní rozsah: -10°C – 80°C

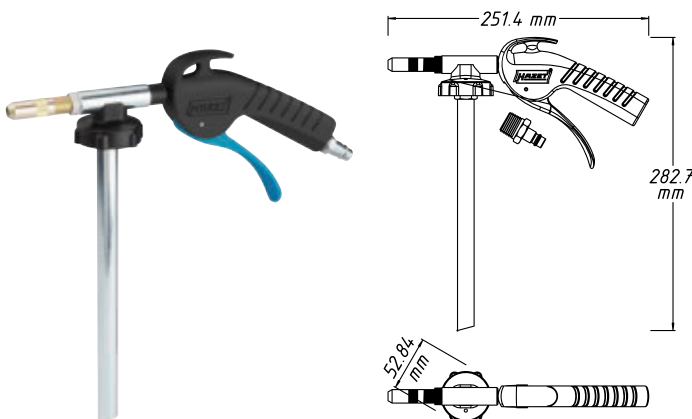

9042 Pistole na karoserie pro ochranu podvozku a utěsnění dutých prostor

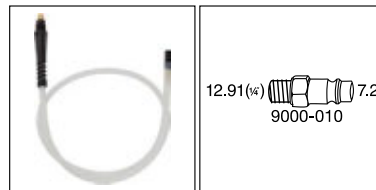

YouTube Clip

HAZET No.	l/min.	EAN-No. 4000896+	€
9042 P-4	251	209613	53,05

9043 Sací/ofukovací pistole · přepínatelná

- Přepínání jednou rukou



- Použití: Odsávání nečistot do sáčku na prach a ofukování povrchů
- Kovové tělo
- Speciální deflektor chrání sáček před poškozením (např. kovovými šponami) tím, že zabráňuje přímému nárazu rychle se pohybujících špon
- Maximální provozní tlak: 10,34 baru
- Úroveň vakua: 7,5 mmHg
- Vzduchová přípojka vstup: Vnitřní závit 12,91 mm (1/4")
- Spojovací konektor: jmenovitá velikost 7,2 (včetně)
- Průměr hadice (doporučeno): 10 mm
- Pracovní tlak [bar]: 6,3
- Hladina akustického výkonu (při provozním tlaku): 97 db(A) Lp W
- Vibrační zrychlení: 0,40 m/s²



YouTube Clip

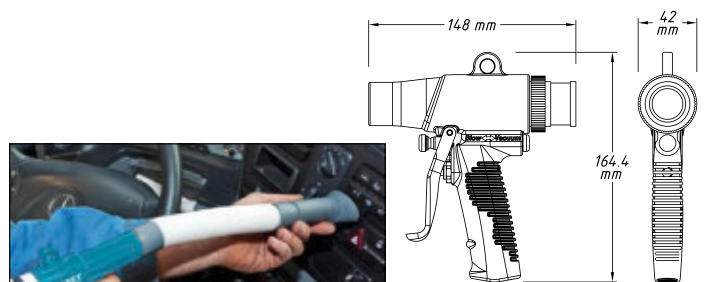

HAZET No.	l/min.	db (A) LpA	g	EAN-No. 4000896+	€
9043 N-10	96	92	403	198382	83,65



9045 Sodová tryskací pistole

- Nepoškozuje pryž, sklo ani plastové díly
- Žádné ohřívání / deformování plechů při tryskání

• Použití: Tryskací pistole na minerály pro šetrné, nepoškozující a ekologické čištění a odlakování s NaHCO₃ (natron)

• Oblastí použití:

- Odstraňování graffiti
- Čištění fasád a památek
- Odlakování dřevěných předmětů
- Odstraňování barvy ze skleněných povrchů a okenních rámců bez poškození skla a těsnění
- Odstraňování nátěrů u lodí bez narušení trupu lodí

• 1 přednastavená přesná kovová tryska pro optimální výkon

• 3 vysoce výkonné široké trysky

• Doplnitelná nádrž o objemu 1,2 l

• Včetně 1 kg sodového minerálního tryskacího prostředku

• Provozní tlak: 6-12 bar

• Rukojeť, spoušť a ventil z acetalového plastu

• Těsnění a O-kroužky z nitrilu

• Pružiny z tvrzené pružinové oceli

• Nádooba z PEHD

• Vzduchová přípojka vstup: Vnitřní závit 12,91 mm (1/4")

• Spojovací konektor: jmenovitá velikost 7,2 (včetně)

• Pracovní tlak [bar]: 6

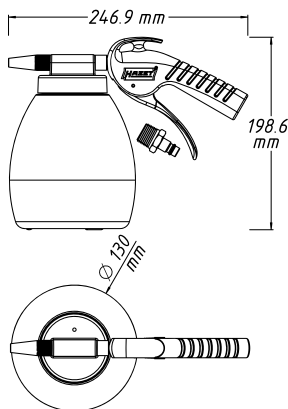

YouTube Clip



12.91 (1/4")
9000-010

9045 P-5 S

HAZET No.	l mm	l/min.	g	EAN-No. 4000896+	€
9045 P-1	247	280	460	209590	132,10
<ul style="list-style-type: none"> • Sodový minerální tryskací prostředek složený z bikarbonátu sodného • Použití <ul style="list-style-type: none"> – odstraňování mj. laků, znečištění šetrné k materiálu – Odstranění laku u dílů karosérie a očištění komponent šetrné odstraňování graffiti a rovněž k čištění fasád a památek – Čištění nástrojů u forem a extrudérů • V praktickém 5 l kanystru s rukojetí • Optimální vlastnosti tečení • Hranatý prášek se střední zrnitostí ~ 25 μm³ 					
9045 P-5 S	-	-	-	210404	40,10

Pneumatické spojovací díly

9040 Spirálová hadice

- Polyuretan
- Délka: 7,62 m
- Vnitřní Ø: 6,35 mm
- Otočný kloub 360° na připojovacím kusu
- Trhací tlak podle DIN: 55,1 baru / 800 PSI
- Pracovní tlak: 10 barů
- Vzduchová přípojka vstup: Vnitřní závit 12,91 mm (1/4"), Spojovací konektor 7,2 mm typ 1 (DE/AT/SI/HU/CN/IN/PT/RU/PL/RO/TR)
- Vzduchová přípojka výstup: Vnější závit 12,91 mm (1/4"), Rychlospojka 7,2 mm typ 1
- Spojovací konektor: jmenovitá velikost 7,2 (včetně)

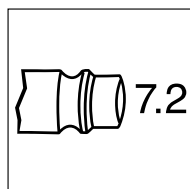

9040 Spirálová hadice

- Vysoce flexibilní polyuretanová hadice s délkou 7,62 m a vnitřním Ø 10 mm

- Otočný kloub 360° na připojovacím kusu
- Trhací tlak podle DIN: 60 barů
- Pracovní tlak: 10 barů
- Závit vzduchové přípojky: 3/8"
- Pracovní délka: 50% až 80% délky hadice
- Bez silikonu
- Maximálně flexibilní
- Vysoce odolná proti oděru
- Tvarově stabilní
- Délka: 7,62 m
- Hadice vnitřní Ø: 10 mm
- Vzduchová přípojka vstup: Vnitřní závit 12,91 mm (1/4"), Spojovací konektor 7,2 mm typ 1 (DE/AT/SI/HU/CN/IN/PT/RU/PL/RO/TR)
- Vzduchová přípojka výstup: Vnější závit 12,91 mm (1/4"), Rychlospojka 7,2 mm typ 1
- Spojovací konektor: jmenovitá velikost 7,2 (včetně)
- Teplotní rozsah: -20°C – 60°C

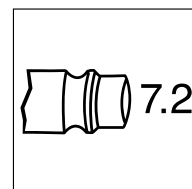

HAZET No.	g	EAN-No. 4000896+	€
9040-7	630	153404	43,45

HAZET No.	l mm	EAN-No. 4000896+	€
9040 S-10	7,6	212361	59,20



Pneumatické nářadí / stroje

Pneumatické spojovací díly



9040 Naviják hadice

- Zastavení hadice v každém bodě možné díky funkci „Stop at any point“
- Čisté navijení skrz automatické vedení
- Brzděné navijení proti nebezpečí nehody
- Vhodné pro tlakový vzduch nebo vodu
- Rozměry: 459x378x205 mm
- Rozměry, zabaleno: 465x400x220 mm
- Hybridní polymerová hadice, černá
- Hadice s vnitřním průměrem: 10 mm
- Délka hadice: 15 m
- Délka připojovací hadice: 0,9 m
- Provozní tlak max: 20 bar
- Integrovaná vrtací šablona pro montáž na kartonovém obalu
- Splňuje všechna příslušná ustanovení směrnice ES o strojních zařízeních 2006/42/ES
- Volitelně lze použít s bezpečnostní spojkou HAZET 9000-061
- Uzavřené tělo ze speciálního plastu s otočným držákem z kovu pro individuální montáž na pracovišti
- Rozteč otvorů na držáku: 186 mm
- Vzduchová přípojka vstup: Vnější závit 16,41 mm (3/8")
- Vzduchová přípojka výstup: Vnější závit 16,41 mm (3/8")
- Automatický naviják hadice obstarává pořádek v dílně – žádná ležící hadice, tedy snížení nebezpečí nehody



YouTube Clip

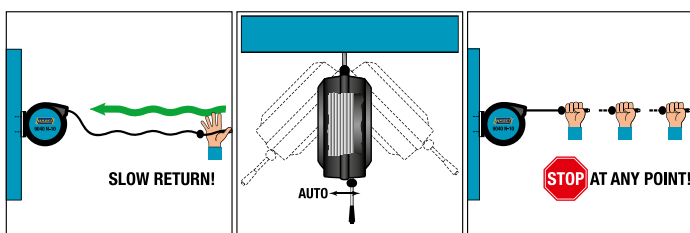
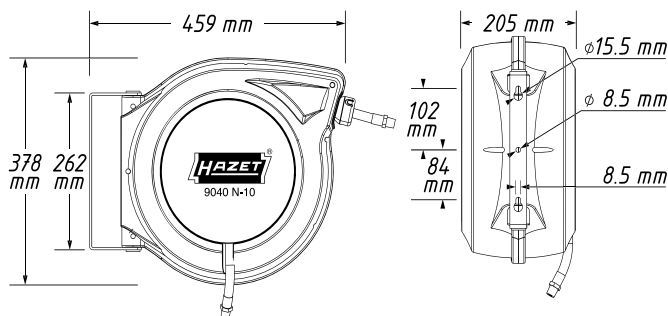

HAZET No.	l mm	g	EAN-No. 4000896+	€
9040 N-10	15	6450	206445	168,70

9040 Naviják hadice

- Zastavení hadice v každém bodě možné díky funkci „Stop at any point“
- Čisté navijení skrz automatické vedení
- Brzděné navijení proti nebezpečí nehody
- Vhodné pro tlakový vzduch nebo vodu
- Rozměry: 500x418 x 210 mm
- Hybridní polymerová hadice, černá
- Hadice s vnitřním průměrem: 13 mm (1/2")
- Délka hadice: 15 m
- Délka připojovací hadice: 1 m
- Provozní tlak max: 20 barů
- Integrovaná vrtací šablona pro montáž na kartonovém obalu
- Splňuje všechna příslušná ustanovení směrnice ES o strojních zařízeních 2006/42/ES
- Uzavřené tělo ze speciálního plastu s otočným držákem z kovu pro individuální montáž na pracovišti, rozteč otvorů na držáku: 186 mm
- Vzduchová přípojka vstup: Vnější závit 20,96 mm (1/2")
- Vzduchová přípojka výstup: Vnější závit 20,96 mm (1/2")
- Teplotní rozsah: -40°C – 80°C



YouTube Clip

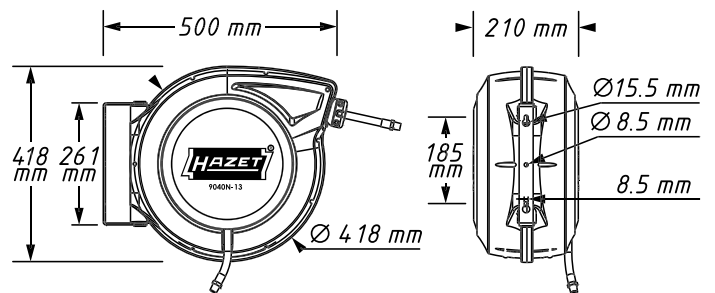

HAZET No.	l mm	g	EAN-No. 4000896+	€
9040 N-13	15	9500	214648	195,20



Nezávazně doporučená ceníková cena bez DPH – Platí do 31.12.2021



9000-040 Otočný kloub s plynulou regulací průtoku vzduchu

- Maximální tlak: 16 barů
- Uvolnění otočné funkce přivedením stlačeného vzduchu, v beztlakovém stavu nepohyblivé
- 12,91 mm / 1/4" závit IG (vnitřní závit)
- 12,91 mm / 1/4" závit AG (vnější závit)
- Vzduchová přípojka vstup: Vnitřní závit 12,91 mm (1/4")
- Vzduchová přípojka výstup: Vnější závit 12,91 mm (1/4")
- Kloub otočný o 360° ve 2 osách
- Regulace průtoku vzduchu pomocí regulačního kolečka



YouTube Clip



HAZET No.	Δ± g	EAN-No. 4000896+	€
9000-040	88	195350	41,80

9000-041 Otočný kloub

- Pneumatický kloub otočný o 360°
- Těsnicí materiál: NBR
- Maximální tlak: 16 barů
- Vzduchová přípojka vstup: Vnitřní závit 12,91 mm (1/4")
- Vzduchová přípojka výstup: Vnější závit 12,91 mm (1/4")
- Povrch: niklováno



YouTube Clip



HAZET No.	Δ± g	EAN-No. 4000896+	€
9000-041	72	204441	17,70

9000-010-014 Sada vsuvek pro přípojku vzduchu

- Adaptace specifických národních norem pro připojení na pneumatické nářadí HAZET

- 12,91 mm / 1/4" závit
- Ocel, poniklovaná
- Provedení s těsnicím prostředkem na závitu
- Vzduchová přípojka vstup: Spojovací konektor 7,2 mm typ 1 (DE/AT/SI/HU/CN/IN/PT/RU/PL/RO/TR)
- Vzduchová přípojka výstup: Vnější závit 12,91 mm (1/4")
- Povrch: niklováno

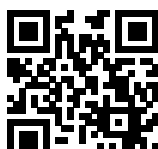

YouTube Clip

HAZET No.	Δ± g	EAN-No. 4000896+	€	
9000-010/3	17	3	195015	8,50

9000-010-014 Sada vsuvek pro přípojku vzduchu

HAZET No.	Δ± g	EAN-No. 4000896+	€	
9000-011/3	16	3	195022	8,50
9000-012/3	20	3	195237	8,50
9000-013/3	20	3	198139	8,50
9000-014/3	20	3	198160	8,50

2162 Minimaznice

- Objem náplně: 80 g
- Vytváří tlak až do 1.000 PSI / 69 bar
- Plnění s volným tukem
- Včetně tlakové maznice v provedení 50° a 90°



9300 N-60

HAZET No.	l / mm	EAN-No. 4000896+	€
2162 M	145	185634	21,80
9300 N-60	-	203406	10,20

9000-020-022 Sada vsuvek pro připojení hadice

- Adaptace národně specifických přípojek na vzduchové hadice

- Hadicová koncovka: Ø 10 mm
- Ocel, poniklovaná
- Vzduchová přípojka vstup: Spojovací konektor 7,2 mm typ 1 (DE/AT/SI/HU/CN/IN/PT/RU/PL/RO/TR)
- Vzduchová přípojka výstup: Hadicová koncovka Ø 10 mm
- Povrch: niklováno
- Použití: Německo (standard), Rakousko, Slovinsko, Maďarsko, Čína, Indie, Portugalsko, Rusko, Polsko, Rumunsko, Turecko



YouTube Clip



HAZET No.	Δ± g	EAN-No. 4000896+	€	
9000-020/3	17	3	195244	8,50



Pneumatické nářadí / stroje

Pneumatické spojovací díly



9000-050-080 Bezpečnostní spojka

- Vhodná pro všechny vsuvky pro přípojku vzduchu (9000-062 pouze pro přípojku vzduchu 10 mm)
- Bezpečné rozpojení spoje (nechtěné rozpojení je vyloučeno)
- Nehrozí nebezpečí úrazu v důsledku vyvrstvení hadice
- Bezpečnostní spojka odtlačuje přípojku před odpojením
- Ovládání jednou rukou
- Nižší námaha při připojování a odpojování
- Odpadá hlasitý hluk při procesu spojování
- Jednoduchá obsluha i v rukavicích
- 9000-050 až 070 mosaz, poniklovaná
- Vzduchová přípojka výstup: Rychlospojka pro typ 1, 2, 3, 4
- Povrch: niklováno



YouTube Clip

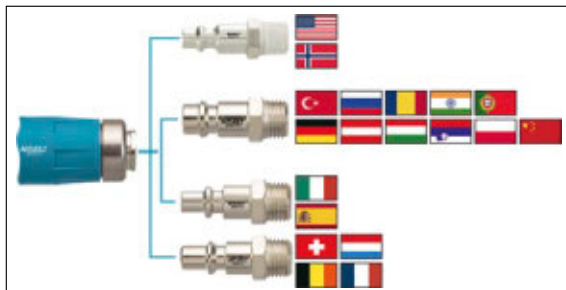

HAZET No.	Δ _g	EAN-No. 4000896+	€
• Vnější závit 12,91 mm / 1/4"			
9000-050	129	195275	35,05
• Vnější závit 16,41 mm / 3/8"			
9000-051	129	195282	35,05
• Vnitřní závit 12,91 mm / 1/4"			
9000-060	122	195312	35,05
• Vnitřní závit 16,41 mm / 3/8"			
9000-061	122	195299	35,05
• Vsuvka pro přípojku vzduchu 10 mm			
• Pro velikost vedení 12,5 mm (1/2 palce)			
• Závit přípojky vzduchu (vnitřní závit) 20,95 mm (1/2")			
9000-062	-	218936	44,95
• Hadicová koncovka: Ø 10 mm			
9000-070	129	195305	46,40
• Sada těsnění pro bezpečnostní spojky 9000-050 · 9000-051 · 9000-060 · 9000-061 · 9000-070			
• Jednoduchá montáž			
9000-01/5	-	234691	6,70

9012 ELSPCS Silikonový ochranný obal

- Chrání těleso vašeho rázového utahováku před poškozením při každodenní náročné práci
- Poloprůhledný ochranný obal
- Montáž bez nutnosti použití nářadí



HAZET No.	EAN-No. 4000896+	€
Silikonový ochranný obal pro 9012 EL-SPC		
9012 EL-SPC-S	222520	10,50
Silikonový ochranný obal pro 9012 M-1		
9012 M-1-S	222735	6,85
Silikonový ochranný obal pro 9011 M a 9012 M		
9012 M-S	202232	6,85
Silikonový ochranný obal pro 9012 SPC · 9012-1 SPC · 9012 P-1		
9012 SPC-S	222476	10,50

9070 Minipřimazávač

- Automatické olejeování k prodloužení životnosti Vašeho pneumatického nářadí

- Použití: Použitelné u většiny motorového pneumatického nářadí
- Možnost dodatečného plnění, plnicí množství 28 ml
- Kompaktní provedení – k upevnění přímo na nástroj
- Mimořádně lehké provedení
- Závitová vložka v plnicím hrdle
- Vzduchová přípojka vstup: Rychlospojka 7,2 mm typ 1
- Vzduchová přípojka výstup: Vnitřní závit 12,91 mm (1/4")
- Pracovní tlak [bar]: 6



HAZET No.	EAN-No. 4000896+	€
9070 N-1	206407	14,90

9000 Omezovač stlačeného vzduchu

- Inline regulátor tlaku k napojení smyčkou do vedení stlačeného vzduchu nebo přímé připojení k pneumatickým zařízením s motorovým pohonem

- Max. vstupní tlak: 10 barů
- Výstupní tlak: 6,3 baru
- Hmotnost včetně vsuvky přívodu vzduchu: 140 g
- Včetně:
 - adaptéru vnější závit 12,91 mm (1/4") na vnější závit 12,91 mm (1/4") pro připojení k zařízení
 - vsuvky vzduchové přípojky 7,2 typ 1 k připojení na tlakovzdušnou spojku
- Pro bezpečný provoz u tlakových vedení do 10 barů
- Vzduchová přípojka vstup: Vnitřní závit 12,91 mm (1/4")
- Vzduchová přípojka výstup: Vnitřní závit 12,91 mm (1/4")

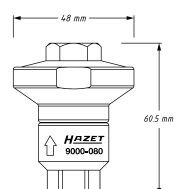

HAZET No.	Δ _g	EAN-No. 4000896+	€
9000-080	100	214709	50,45



Príslušenství pro pneumatické nářadí

9070 Jednotka údržby

- 2násobná, obsahující redukční tlakový ventil, mlhovou maznici a manometr
- Přípojka tlakoměru: 3,2 mm (1/8")
- Max. tlak: 16 bar (1/2" a 3/8") 12 bar (1/4"), Maximální pracovní tlak: 12 bar (1/2" a 3/8") 10 bar (1/4")
- Zobrazení tlaku: 0,5–12 barů
- Stupeň filtrace: 10 µm
- Použijte olej: třída oleje F (Sprinter ADVP 22)



HAZET No.	g	EAN-No. 4000896+	€
<ul style="list-style-type: none"> • Závit vzduchové přípojky 20,67 mm (1/2") • Průtok vzduchu při 6,3 baru: 5000 NI/min • Objem náplně regulátoru tlaku: 50 ml • Objem mlhové maznice: 170 ml 	1380	153343	151,20
<ul style="list-style-type: none"> • Závit vzduchové přípojky 12,91 mm (1/4") • Průtok vzduchu při 6,3 baru: 1800 NI/min • Objem náplně regulátoru tlaku: 30 ml • Objem mlhové maznice: 40 ml 	580	153367	128,20

9070 Redukční tlakový ventil

- Skládá se z redukčního tlakového ventilu a manometru
- Přípojka tlakoměru: 3,2 mm (1/8")
- Max. tlak: 16 bar (1/2" a 3/8") 12 bar (1/4"), Maximální pracovní tlak: 12 bar (1/2" a 3/8") 10 bar (1/4")
- Zobrazení tlaku: 0,5–12 barů
- Stupeň filtrace: 10 µm
- Objem náplně regulátoru tlaku: 50 ml



HAZET No.	g	EAN-No. 4000896+	€
<ul style="list-style-type: none"> • Závit vzduchové přípojky 20,67 mm (1/2") • Průtok vzduchu při 6,3 baru: 5000 NI/min 	890	153374	86,60
<ul style="list-style-type: none"> • Závit vzduchové přípojky 12,91 mm (1/4") • Průtok vzduchu při 6,3 baru: 1800 NI/min 	380	153398	72,-

9400 Speciální olej pro pneumatické nářadí

- **Made in Germany**
- Snižuje opotřebení vzduchového motoru
- Speciální olej bez silikonu
- Zajišťuje maximální výkon při denním použití
- Prodloužení životnosti strojů



HAZET No.	g	EAN-No. 4000896+	€
<ul style="list-style-type: none"> • Objem náplně 100 ml • Vývod pro přímé použití • S uzavíracím víčkem • Použití v motoru pneumatického nářadí jako rázové utahovky, brusky atd. 	11	191390	7,35
<ul style="list-style-type: none"> • Objem náplně 1 000 ml • Průhledné zobrazení stavu naplnění • Použití v motoru pneumatického nářadí jako rázové utahovky, brusky atd. 	838	191406	19,20

9070 Magnetický držák

- Dva silné magnety pro uchycení 1 rázového utahovku a 4 nástrčných hlavíc
- Nosnost: 10 kg

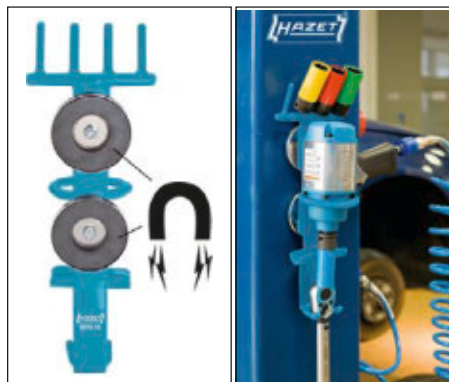

HAZET No.	g	EAN-No. 4000896+	€
	1510	158157	49,10



Pneumatické nářadí / stroje

HAZET SERVIS pro momentové klíče a pneumatické nástroje



HAZET SERVIS pro momentové klíče a pneumatické nástroje

SP1-4 HAZET SERVIS pro momentové klíče a pneumatické nástroje

Made in Germany

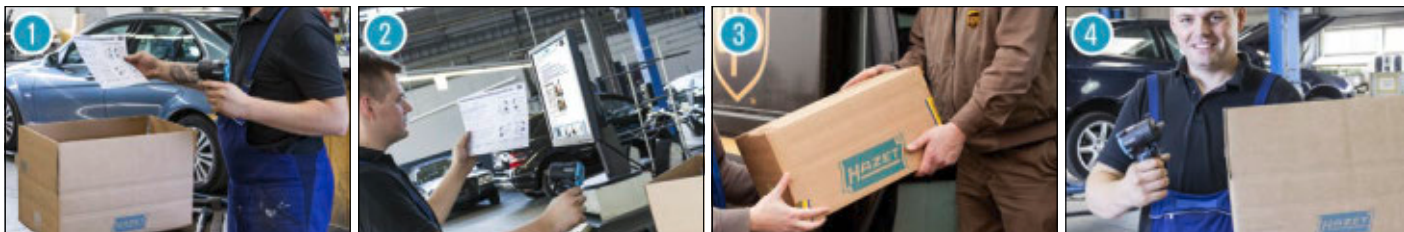

Všechny momentové a pneumatické nástroje HAZET jsou servisovatelné! Kromě oprav v servisním centru HAZET nabízíme pro momentové klíče kontroly v závodě až po kalibraci ve vlastní kalibrační laboratoři DAKKS. Ohledně všech výkonů servisního centra HAZET a nabídky servisu na místě Vám rád poradí váš lokální partner HAZET.

9040 D Naviják kabelu

- Zastavení hadice v každém bodě možné díky funkci „Stop at any point“
- Čisté navijení skrz automatické vedení
- Brzděné navijení proti nebezpečí nehody

- Včetně jističe vedení
- 230 V AC
- Vhodný pouze pro použití ve vnitřních prostorech
- Vedení: H07RN-F 3x2,5 mm²
- Délka vedení: 20 m
- Délka připojovacího vedení: 1,5 m
- Integrovaná vrtací šablona pro montáž na kartonovém obalu
- Uzavřené tělo ze speciálního plastu
- Otočný držák z kovu pro individuální montáž na pracovišti
- Rozteč otvorů na držáku: 186 mm
- Zatížitelné v navinutém stavu 1600 wattů
- Zatížitelné v odvinutém stavu 3200 wattů
- Splňuje všechna příslušná ustanovení směrnice ES o strojních zařízeních 2006/42/ES
- Stupeň krytí (IP): IP20
- Teplotní rozsah: -20°C – 45°C



YouTube Clip

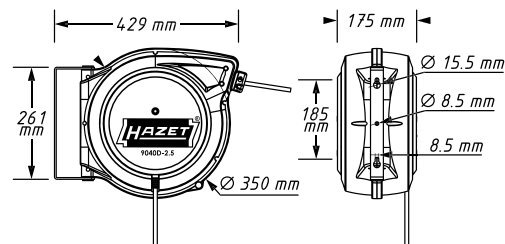

HAZET No.

9040 D-2.5



9200

EAN-No. 4000896+

214631



232,40



System Aku nástrojů HAZET 18 V

S Aku výkonem k perfektním pracovním výsledkům!

Aku nástroje patří k základnímu vybavení každé profi dílny. HAZET nabízí u obou 2 Ah a 5 Ah akumulátorů systém výkonných Aku nástrojů v různých sadách. K tomu patří kromě Aku šroubováků vrtačka a úhlová bruska. Všechny tyto nástroje jsou k dostání jako **3dílná sada** s nabíječkou a akumulátorem, jako **4dílná sada** s nabíječkou a **dvěma akumulátory** nebo také vždy pouze jako **základní přístroj bez příslušenství** k dostání pro ty, kteří již mají příslušné akumulátory HAZET. Příslušné detaily k produktům naleznete na následujících stranách.

9233-7

Sada úhlové brusky

- **Obsah** (3dílná sada):
1 akumulátorová úhlová bruska
1 rychlonabíječka
1 akumulátor Li-Ion 18 V, 5.0 Ah
Dodání v plastovém kufru
- **Volitelně:**
1 další 2.0 Ah nebo 5.0 Ah Aku
sady dělicích a hrubovacích kotoučů



9230-2

Sada akumulátorové vrtačky

- **Obsah** (3dílná sada):
1 akumulátorový šroubovák
1 rychlonabíječka
1 akumulátor Li-Ion 18 V, 2.0 Ah
Dodání v plastovém kufru
- **Volitelně:**
1 další 2.0 Ah nebo 5.0 Ah Aku





Sady Aku rázových utahováků

- **Obsah** (3dílná sada):
1 aku rázový utahovák
1 rychlonabíječka
1 Li-Ion akumulátor 18 V, 5.0 Ah příp. 2.0 Ah
- **Volitelně:**
1 další 2.0 Ah nebo 5.0 Ah Aku



12⁵ 1/2"

9212 SPC-1



12⁵ 1/2"

9212 M-1



12⁵ 1/2"

9212-3



12⁵ 1/2"

9212-1000



20 3/4"

9213-1000

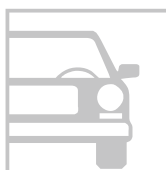

Každý akumulátor se hodí na každý přístroj!

Plný výkon HAZET, plná kompatibilita!

Je zcela jedno zda 2 nebo 5 Ah!





Aku rázový utahovák

9212 SPC Aku rázový utahovák 18 V

• Osvětlení pracovního prostoru již před pohybem hnacího mechanismu

- Extrémně snadno ovladatelný nástroj
- Lehké provedení
- Velikost proudu bez zatížení: 5 A
- Akumulátory Li-Ion s výrazně nižším samovybitím (jen 2 %) než běžné akumulátory NiMH (15-25 %)
- Náhradní akumulátor: 9212-02
- Čistá hmotnost: 1,060 kg (bez akumulátoru)
- Čistá hmotnost akumulátoru: 0,390 kg
- Čistá hmotnost nabíječky: 0,66 kg
- Včetně příchytky na opasek (lze namontovat oboustranně) a ručního poutka
- Celková délka: 167 mm
- Výška: 187 mm
- Šířka: 65 mm
- Doporučený utahovací moment: 200 Nm
- Hladina akustického výkonu (při provozním tlaku): 111 db(A) Lp W
- Vibrační zrychlení: 14,91 m/s²
- Povolovací moment (max.) zjištěný s velikostí šroubu M: 16

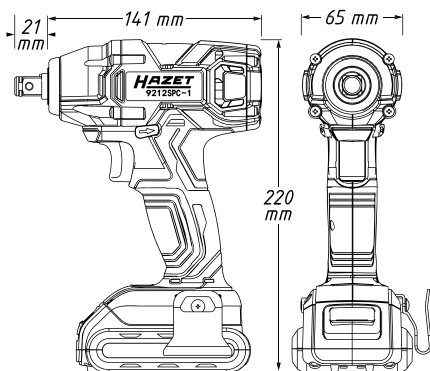

HAZET No.	max. Nm	max. Nm	ot./min.	db (A) LpA	g	FAN-No. 4000896+	€
• 3dílná sada, obsah: akumulátorový rázový utahovák, nabíječka, akumulátor Li-Ion 9212-02 (1x)							
9212 SPC-1	260	200	0-2700	100	1450	3	212439 257,50
• 4dílná sada, obsah: akumulátorový rázový utahovák, nabíječka, akumulátor Li-Ion 9212-02 (2x)							
9212 SPC-1/4	260	200	0-2700	100	-	4	214259 350,60
• Základní přístroj akumulátorový rázový utahovák, bez akumulátoru							
9212 SPC-010	260	200	0-2700	100	1060	-	214273 163,40
• Akumulátor, samostatný							
• Li-Ion, 18 V, 2 Ah							
Pro 9212-3 · 9212 M-1 · 9212 M-1/4 · 9212 SPC-1 · 9212 SPC-1/4 9230-2 · 9230-2/4 · 9233-7 · 9233-7/4							
9212-02	-	-	-	-	390	-	213788 174,30

9212 SPC Aku rázový utahovák 18 V

HAZET No.	max. Nm	max. Nm	ot./min.	db (A) LpA	g	FAN-No. 4000896+	€
• Akumulátor, samostatný							
• Li-Ion, 18 V, 5 Ah							
Pro 9212-3 · 9212 M-1 · 9212 M-1/4 · 9212 SPC-1 · 9212 SPC-1/4 9230-2 · 9230-2/4 · 9233-7 · 9233-7/4							
9212-05	-	-	-	-	700	-	210367 281,50
• Nabíječka							
Pro 9212-3 · 9212 M-1 · 9212 M-1/4 · 9212 SPC-1 · 9212 SPC-1/4 9230-2 · 9230-2/4 · 9233-7 · 9233-7/4							
9212-03	-	-	-	-	660	-	204823 107,-

9212 M Aku rázový mini utahovák 18 V

- **Vysoká efektivita díky bezkartáčovému motoru**
- **Snadno ovladatelný, krátký a lehký nástroj**

- Tři volitelné výkonové stupně pro utahovací moment
 1. stupeň: cca 80 Nm při 700 ot./min
 2. stupeň: cca 150 Nm při 1600 ot./min
 3. stupeň: cca 220 Nm při 2500 ot./min
- Velikost proudu bez zatížení: 4,5 A
- Doba nabíjení ~ 35 minut
- **Bezkartáčový stejnosměrný motor (BLDC):**
 - Delší životnost, menší opotřebení, není potřeba výměna uhlíkových kartáčů
 - Vysoký stupeň účinnosti a tím menší spotřeba akumulátoru
 - Kompaktnější motor umožňuje menší konstrukční rozměry
- Osvětlení pracovního prostoru již před pohybem hnacího mechanismu
- Akumulátory Li-Ion s výrazně nižším samovybitím (jen 2 %) než běžné akumulátory NiMH (15-25 %)
- Čistá hmotnost: 0,954 kg (bez akumulátoru)
- Čistá hmotnost akumulátoru: 0,365 kg
- Čistá hmotnost nabíječky: 0,66 kg
- Rozměry včetně akumulátoru: 228 x 63 x 135 mm
- Včetně příchytky na opasek (lze namontovat oboustranně) a ručního poutka
- Doporučený utahovací moment: 220 Nm
- Hladina akustického výkonu (při provozním tlaku): 110,6 db(A) Lp W
- Vibrační zrychlení: 15,40 m/s²
- Povolovací moment (max.) zjištěný s velikostí šroubu M: 16





Pneumatické nářadí / stroje

Aku rázový utahovák



9212 M Aku rázový mini utahovák 18 V



YouTube Clip

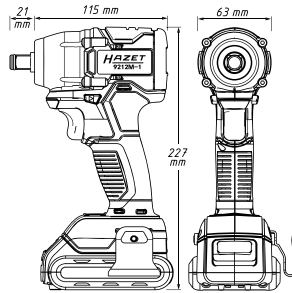

HAZET No.	max. Nm	max. Nm	ot./min.	db (A) LpA	g	EAN-No. 4000896+	€
• 3dílná sada, obsah: akumulátorový rázový utahovák, nabíječka, akumulátor Li-Ion 9212-02 (1x)							
9212 M-1	270	220	0-2500	99,6	1340	3	212446 360,60
• 4dílná sada, obsah: akumulátorový rázový utahovák, nabíječka, akumulátor Li-Ion 9212-02 (2x)							
9212 M-1/4	270	220	0-2500	99,6	-	4	214266 443,70
• Základní přístroj akumulátorový rázový mini utahovák, bez akumulátoru							
9212 M-010	270	220	0-2500	99,6	950	-	214280 327,60
• Akumulátor, samostatný							
• Li-Ion, 18 V, 2 Ah							
Pro 9212-3 · 9212 M-1 · 9212 M-1/4 · 9212 SPC-1 · 9212 SPC-1/4 · 9230-2 · 9230-2/4 · 9233-7 · 9233-7/4							
9212-02	-	-	-	-	390	-	213788 174,30
• Akumulátor, samostatný							
• Li-Ion, 18 V, 5 Ah							
Pro 9212-3 · 9212 M-1 · 9212 M-1/4 · 9212 SPC-1 · 9212 SPC-1/4 · 9230-2 · 9230-2/4 · 9233-7 · 9233-7/4							
9212-05	-	-	-	-	700	-	210367 281,50
• Nabíječka							
Pro 9212-3 · 9212 M-1 · 9212 M-1/4 · 9212 SPC-1 · 9212 SPC-1/4 · 9230-2 · 9230-2/4 · 9233-7 · 9233-7/4							
9212-03	-	-	-	-	660	-	204823 107,-

9212 Sada akumulátorového rázového utahováku

• Vysoká efektivita díky bezkartáčovému motoru

12S 1/2

18 V, 5 Ah

- Tři volitelné výkonové stupně pro utahovací moment
 1. stupeň: cca 80 Nm při 600 ot./min při ~1700 úderech za minutu
 2. stupeň: cca 300 Nm při 1400 ot./min při ~ 2500 úderech za minutu
 3. stupeň: cca 500 Nm při 2000 ot./min při ~3400 úderech za minutu
- Osvětlení pracovního prostoru již před pohybem hnacího mechanismu
- Akumulátory Li-Ion s výrazně nižším samovybitením (jen 2 %) než běžné akumulátory NiMH (15-25%)
- Velikost proudu bez zatížení: 5,5 A
- Náhradní akumulátor: 9212-05
- Čistá hmotnost: 1,857 kg (bez akumulátoru)
- Čistá hmotnost akumulátoru: 0,659 kg
- Čistá hmotnost nabíječky: 0,66 kg
- Čistá hmotnost kufříku: 4,352 kg
- Rozměry včetně akumulátoru: 204 x 64 x 259 mm
- Včetně příchytky na opasek, lze namontovat oboustranně
- **Bezkartáčový stejnosměrný motor (BLDC)**
 - Delší životnost, menší opotřebení, není potřeba výměna uhlíkových kartáčů
 - Vysoký stupeň účinnosti a tím menší spotřeba akumulátoru
 - Kompaktnější motor umožňuje menší konstrukční rozměry
- Doporučený utahovací moment: 500 Nm
- Hladina akustického výkonu (při provozním tlaku): 110,4 db(A) Lp W
- Vibrační zrychlení: 20,30 m/s²
- Povolovací moment (max.) zjištěný s velikostí šroubu M: 16
- Právý/levý chod: vícestupňově (doleva/doprava)
- Plastová skříňka



9212 Sada akumulátorového rázového utahováku

12S 1/2



YouTube Clip



360°

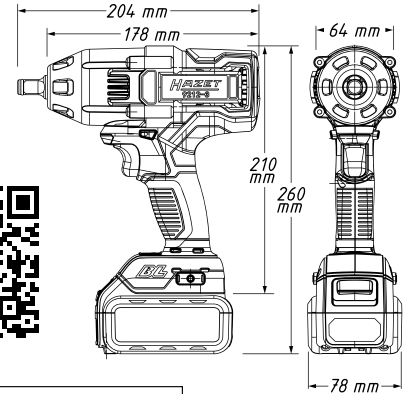

HAZET No.	max. Nm	max. Nm	ot./min.	db (A) LpA	g	EAN-No. 4000896+	€
• 3dílná sada, obsah: akumulátorový rázový utahovák, nabíječka, akumulátor Li-Ion (1x)							
9212-3	700	500	0-2000	99,4	1857	3	203444 682,-
• Nabíječka							
Pro 9212-3 · 9212 M-1 · 9212 M-1/4 · 9212 SPC-1 · 9212 SPC-1/4 · 9230-2 · 9230-2/4 · 9233-7 · 9233-7/4							
9212-03	-	-	-	-	660	-	204823 107,-
• Akumulátor, samostatný							
• Li-Ion, 18 V, 5 Ah							
Pro 9212-3 · 9212 M-1 · 9212 M-1/4 · 9212 SPC-1 · 9212 SPC-1/4 · 9230-2 · 9230-2/4 · 9233-7 · 9233-7/4							
9212-05	-	-	-	-	700	-	210367 281,50





9212-1000 Aku rázový utahovák

- Vysoká efektivita díky bezkartáčovému motoru

18 V, 5 Ah

- Vhodné pro trvalý provoz
- Robustní tělo přístroje
- Tři volitelné výkonové stupně pro utahovací moment
 1. stupeň: cca 180 Nm při 0-400 ot./min
 2. stupeň: cca 400 Nm při 0-800 ot./min
 3. stupeň: cca 1000 Nm při 0- 1800 ot./min
- Osvětlení pracovního prostoru již před pohybem hnacího mechanismu
- Akumulátory Li-Ion s výrazně nižším samovybitením (jen 2 %) než běžné akumulátory NiMH (15-25%)
- Náhradní akumulátor: 9212-05
- Čistá hmotnost akumulátoru: 0,659 kg
- Čistá hmotnost nabíječky: 0,66 kg
- Čistá hmotnost kufříku: 2,15 kg
- Rozměry včetně akumulátoru: 278x230x89,5 mm
- Včetně přichytky na opasek, lze namontovat oboustranně
- **Bezkartáčový stejnosměrný motor (BLDC)**
 - Delší životnost, menší opotřebení, není potřeba výměna uhlíkových kartáčů
 - Vysoký stupeň účinnosti a tím menší spotřeba akumulátoru
 - Kompaktnější motor umožňuje menší konstrukční rozměry
- Doba nabíjení u 5 Ah akumulátoru cca 80 minut
- Hladina akustického výkonu (při provozním tlaku): 112 db(A) Lp W
- Vibrační zrychlení: 17,80 m/s²
- Povolovací moment (max.) zjištěný s velikostí šroubu M: 24
- Právý/levý chod: víceúhňové (doleva/doprava)



YouTube Clip

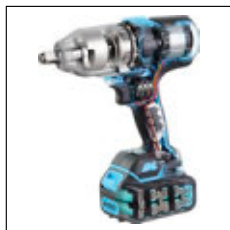
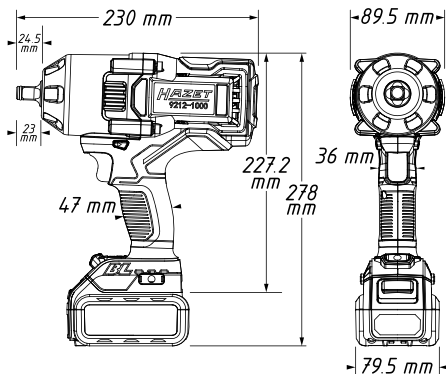

HAZET No.	max. Nm	max. Nm	ot./min.	db (A) LpA	g	EAN-No. 4000896+	€
• 3dílná sada, obsah: akumulátorový rázový utahovák, nabíječka, akumulátor Li-Ion (1x)							
9212-1000/3	1400	1000	0-1800	101	3640	3 222674	747,-
• 4dílná sada, obsah: akumulátorový rázový utahovák, nabíječka, akumulátor Li-Ion (2x)							
9212-1000/4	1400	1000	0-1800	101	3640	4 222681	872,-

9212-1000 Aku rázový utahovák

HAZET No.	max. Nm	max. Nm	ot./min.	db (A) LpA	g	EAN-No. 4000896+	€
• Základní přístroj akumulátorový rázový utahovák, bez akumulátoru							
9212-1000	1400	1000	0-1800	101	3640	- 222711	560,-
• Akumulátor, samostatný							
• Li-Ion, 18 V, 2 Ah							
• Pro 9212-3 · 9212 M-1 · 9212 M-1/4 · 9212 SPC-1 · 9212 SPC-1/4 9230-2 · 9230-2/4 · 9233-7 · 9233-7/4							
9212-02	-	-	-	-	390	- 213788	174,30
• Akumulátor, samostatný							
• Li-Ion, 18 V, 5 Ah							
• Pro 9212-3 · 9212 M-1 · 9212 M-1/4 · 9212 SPC-1 · 9212 SPC-1/4 9230-2 · 9230-2/4 · 9233-7 · 9233-7/4							
9212-05	-	-	-	-	700	- 210367	281,50
• Nabíječka							
• Pro 9212-3 · 9212 M-1 · 9212 M-1/4 · 9212 SPC-1 · 9212 SPC-1/4 9230-2 · 9230-2/4 · 9233-7 · 9233-7/4							
9212-03	-	-	-	-	660	- 204823	107,-

9213-1000 Aku rázový utahovák

- Vysoká efektivita díky bezkartáčovému motoru

18 V, 5 Ah

- Vhodné pro trvalý provoz
- Robustní tělo přístroje
- Tři volitelné výkonové stupně pro utahovací moment
 1. stupeň: cca 180 Nm při 0-400 ot./min
 2. stupeň: cca 400 Nm při 0-800 ot./min
 3. stupeň: cca 1000 Nm při 0- 1800 ot./min
- Osvětlení pracovního prostoru již před pohybem hnacího mechanismu
- Akumulátory Li-Ion s výrazně nižším samovybitením (jen 2 %) než běžné akumulátory NiMH (15-25%)
- Náhradní akumulátor: 9212-05
- Čistá hmotnost akumulátoru: 0,659 kg
- Čistá hmotnost nabíječky: 0,66 kg
- Čistá hmotnost kufříku: 2,15 kg
- Rozměry včetně akumulátoru: 278x230x89,5 mm
- Včetně přichytky na opasek, lze namontovat oboustranně
- **Bezkartáčový stejnosměrný motor (BLDC)**
 - Delší životnost, menší opotřebení, není potřeba výměna uhlíkových kartáčů
 - Vysoký stupeň účinnosti a tím menší spotřeba akumulátoru
 - Kompaktnější motor umožňuje menší konstrukční rozměry
- Doba nabíjení u 5 Ah akumulátoru cca 80 minut
- Hladina akustického výkonu (při provozním tlaku): 112 db(A) Lp W
- Vibrační zrychlení: 17,80 m/s²
- Povolovací moment (max.) zjištěný s velikostí šroubu M: 24
- Právý/levý chod: víceúhňové (doleva/doprava)

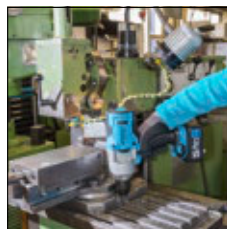



Pneumatické nářadí / stroje

Akumulátorová vrtačka / úhlová bruska



9213-1000 Aku rázový utahovák



YouTube Clip

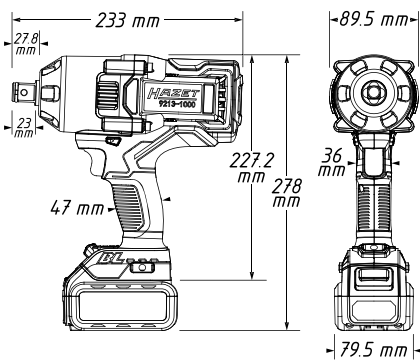

HAZET No.	max. Nm	max. Nm	ot./min.	db (A) LpA	g	EAN-No. 4000896+	€
• 3dílná sada, obsah: akumulátorový rázový utahovák, nabíječka, akumulátor Li-Ion (1x)							
9213-1000/3	1400	1000	0-1800	101	3700	3 222704	747,-
• 4dílná sada, obsah: akumulátorový rázový utahovák, nabíječka, akumulátor Li-Ion (2x)							
9213-1000/4	1400	1000	0-1800	101	3700	4 222797	889,-
• Základní přístroj akumulátorový rázový utahovák, bez akumulátoru							
9213-1000	1400	1000	0-1800	101	3700	- 222698	560,-
• Akumulátor, samostatný							
• Li-Ion, 18 V, 2 Ah							
Pro 9212-3 · 9212 M-1 · 9212 M-1/4 · 9212 SPC-1 · 9212 SPC-1/4 9230-2 · 9230-2/4 · 9233-7 · 9233-7/4							
9212-02	-	-	-	-	390	- 213788	174,30
• Akumulátor, samostatný							
• Li-Ion, 18 V, 5 Ah							
Pro 9212-3 · 9212 M-1 · 9212 M-1/4 · 9212 SPC-1 · 9212 SPC-1/4 9230-2 · 9230-2/4 · 9233-7 · 9233-7/4							
9212-05	-	-	-	-	700	- 210367	281,50
• Nabíječka							
Pro 9212-3 · 9212 M-1 · 9212 M-1/4 · 9212 SPC-1 · 9212 SPC-1/4 9230-2 · 9230-2/4 · 9233-7 · 9233-7/4							
9212-03	-	-	-	-	660	- 204823	107,-



Jednotlivé a náhradní díly od strany 482 po stranu 490

Akumulátorová vrtačka / úhlová bruska

9230 Akumulátorová vrtačka

• Vysoká efektivita díky bezkartáčovému motoru

- 18 V, 2 Ah
- Kompatibilní s akumulátory HAZET 9212-02 a 9212-05
- Rychloupínací kovové sklíčidlo bez nářadí 1-13 mm
- Volitelné stupně utahovacího momentu 15 + 1 vrtání
- Otáčky za minutu stupeň 1: 0-560
Otáčky za minutu stupeň 2: 0-1900
- Vibrační zrychlení šroubování: 0,8 m/s²
Vibrační zrychlení vrtání: 2,3 m/s²
- Robustní těleso stroje
- Vhodné pro trvalý provoz
- Včetně příchytka na opasek, lze namontovat oboustranně
- Hmotnost s akumulátorem: 1,68 kg
Hmotnost bez akumulátoru: 1,27 kg
- **Bezkartáčový stejnosměrný motor (BLDC):**
 - Delší životnost, menší opotřebení, není potřeba výměna uhlíkových kartáčů
 - Vysoký stupeň účinnosti a tím menší spotřeba akumulátoru – kompaktnější motor umožňuje menší konstrukční rozměry
- Plastová taška



YouTube Clip

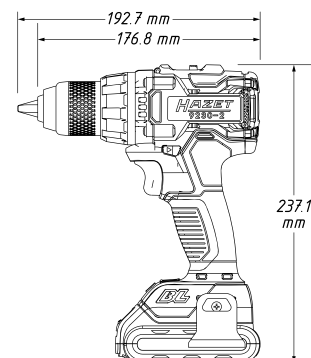

HAZET No.	max. Nm	db (A) LpA	g	EAN-No. 4000896+	€
• 3dílná sada 1 akumulátorová vrtačka 1 rychlonabíječka (40 minut) 1 akumulátory Li-Ion 18 V, 2 Ah					
• Dodávka v robustní brašně					
9230-2	60	68	-	3 218370	389,10
• 4dílná sada 1 akumulátorová vrtačka 1 rychlonabíječka (40 minut) 2 akumulátory Li-Ion 18 V, 2 Ah					
• Dodávka v robustní brašně					
9230-2/4	60	68	-	4 218967	454,70
• Základní přístroj akumulátorová vrtačka, bez akumulátoru, bez nabíječky					
9230-010	60	68	-	- 218974	213,80
• Akumulátor, samostatný					
• Li-Ion, 18 V, 2 Ah					
Pro 9212-3 · 9212 M-1 · 9212 M-1/4 · 9212 SPC-1 · 9212 SPC-1/4 9230-2 · 9230-2/4 · 9233-7 · 9233-7/4					
9212-02	-	-	390	- 213788	174,30
• Akumulátor, samostatný					
• Li-Ion, 18 V, 5 Ah					
Pro 9212-3 · 9212 M-1 · 9212 M-1/4 · 9212 SPC-1 · 9212 SPC-1/4 9230-2 · 9230-2/4 · 9233-7 · 9233-7/4					
9212-05	-	-	700	- 210367	281,50
• Nabíječka					
Pro 9212-3 · 9212 M-1 · 9212 M-1/4 · 9212 SPC-1 · 9212 SPC-1/4 9230-2 · 9230-2/4 · 9233-7 · 9233-7/4					
9212-03	-	-	660	- 204823	107,-

Nezávazně doporučená ceníková cena bez DPH – Platí do 31.12.2021



9233 Akumulátorová úhlová bruska

- Vysoká efektivita díky bezkartáčovému motoru
- Kompatibilní s akumulátory HAZET 9212-02 a 9212-05
- Ergonomický a kompaktní design pouzdra
- Přístroj se zastaví při silné ztrátě otáček na základě zkroucení
- Funkce proti neúmyslnému spuštění motoru při výměně akumulátoru
- Síťová tkanina chrání motor proti znečištění
- Zastavení motoru 2 sekundy po vypnutí
- Extrémně plochá hlava s malým úhlem
- Konstantní rychlost i při těžké práci
- Pozvolný rozběh motoru pro vyšší komfort
- Bezpečnostní spouštěcí páčka
- Postranní rukojeť použitelná vpravo i vlevo
- Včetně vždy 1 ochranného krytu
 - pro rozbrušovací kotouče
 - pro hrubovací kotouče
- Rychlé nastavení ochranného krytu bez nářadí
- Závit vřetena: M 14
- Aretace vřetene
- Hmotnost s akumulátorem: 2,28 kg
- Hmotnost bez akumulátoru: 1,53 kg
- Vibrační zrychlení: 7,90 m/s²



YouTube Clip

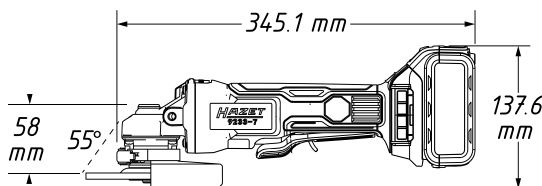
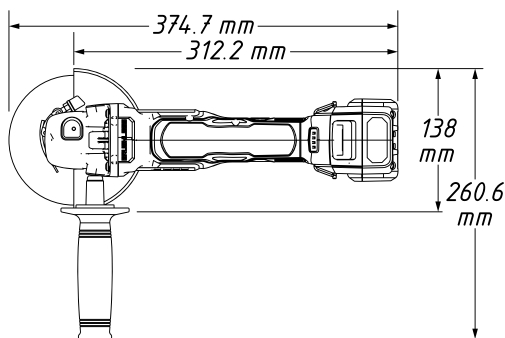

9233 Akumulátorová úhlová bruska

HAZET No.	l mm	ot./min.	db (A) LpA	g		EAN-No. 4000896+	€
• 3dílná sada							
1 akumulátorová úhlová bruska							
1 rychlonabíječka							
1 akumulátor Li-Ion 18 V, 5 Ah							
9233-7	345,1	8000	89	–	–	218325	516,–
• 4dílná sada							
1 akumulátorová úhlová bruska							
1 rychlonabíječka							
2 akumulátor Li-Ion 18 V, 5 Ah							
9233-7/4	345,1	8000	89	–	4	218950	648,–
• Sada rozbrušovacích kotoučů, 5dílná							
• Pro 9233-7 · 9233-7/4							
9233-010/5	–	–	–	–	5	219063	9,15
• Sada rozbrušovacích kotoučů, 25dílná							
• Pro 9233-7 · 9233-7/4							
9233-010/25	–	–	–	–	25	219070	38,90
• Sada hrubovacích kotoučů, 10dílná							
• Pro 9233-7 · 9233-7/4							
9233-011/10	–	–	–	–	10	219087	27,45
• Základní přístroj akumulátorová úhlová bruska, bez akumulátoru							
9233-010	345,1	8000	89	–	–	218943	389,10
• Akumulátor, samostatný							
• Li-Ion, 18 V, 2 Ah							
• Pro 9212-3 · 9212 M-1 · 9212 M-1/4 · 9212 SPC-1 · 9212 SPC-1/4							
9230-2 · 9230-2/4 · 9233-7 · 9233-7/4							
9212-02	–	–	–	390	–	213788	174,30
• Akumulátor, samostatný							
• Li-Ion, 18 V, 5 Ah							
• Pro 9212-3 · 9212 M-1 · 9212 M-1/4 · 9212 SPC-1 · 9212 SPC-1/4							
9230-2 · 9230-2/4 · 9233-7 · 9233-7/4							
9212-05	–	–	–	700	–	210367	281,50
• Nabíječka							
• Pro 9212-3 · 9212 M-1 · 9212 M-1/4 · 9212 SPC-1 · 9212 SPC-1/4							
9230-2 · 9230-2/4 · 9233-7 · 9233-7/4							
9212-03	–	–	–	660	–	204823	107,–

Horkovzdušné ruční přístroje

1990 Horkovzdušná pistole

- Mnoho extra funkcí
- Výkon: **2000 wattů**
- Teplotní rozsah s elektronickou plynulou regulací
- Rozsah množství vzduchu: **200–550 l/min s elektronickou plynulou regulací**
- Průvodce menu v 8 jazycích (D, ES, FR, GB, IT, NL, PT, SE)
- 6dílná sada, obsah
 - : horkovzdušná pistole, 1 tryska nerezová svařovací, 1 přelátovací, 1 pájecí reflektorová a 1 reflektorová, 1 přítláčný váleček
- 7 předprogramovaných nastavení pro speciální svařování plastů (je nutné zadat jen plastový materiál – teplota a proud vzduchu jsou naprogramovány)
- Regulace skutečné teploty při použití všech trysek díky uzavřenému, elektronicky řízenému okruhu
- Stand-By (nízká spotřeba proudu v režimu ECO při konstantní teplotě)
- Nasávaný vzduch není foukán přes motor – to zabraňuje znečištění motoru
- 14 funkčních programů
- Optimální ergonomie – dobré vyvážení – lze postavit nastojato
- Chráněná keramika pro optimální izolaci
- LCD displej
- Plastová skříňka
- Teplotní rozsah: 80°C – 650°C





Pneumatické nářadí / stroje

Horkovzdušné ruční přístroje



1990 Horkovzdušná pistole



1990 Horkovzdušná pistole

• Základní provedení s vynikajícím poměrem ceny / výkonu

- Výkon: **1600 W**
- 2 rozsahy množství vzduchu: **350 / 500 l/min (dvoustupňový spínač)**
- Silný keramický ohřev, optimální chlazení přístroje a výkonný motor zaručují dlouhou životnost
- Nasávání vzduch není foukán přes motor – to zabraňuje znečištění motoru
- Optimální, dobře vyvážená ergonomie
- Lze postavit na výšku (pohotovostní uložení)
- Včetně ochrany topného článku
- Elektronika: vyhovující flickr
- Teplotní rozsah: 350°C – 500°C

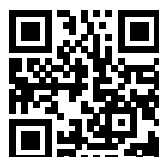

YouTube Clip



HAZET No.		EAN-No. 4000896+	€
1990-2/6	6	141586	318,50

HAZET No.	EAN-No. 4000896+	€
1990-10	218271	81,-

HAZET
Das Werkzeug

12⁵ 1/2" 700 Nm 9212-3

12⁵ 1/2" 1400 Nm 9212-1000

12⁵ 1/2" 270 Nm 9212 M-1

12⁵ 1/2" 260 Nm 9212 SPC-1

20 3/4" 1400 Nm 9213-1000

2.0 Ah 9212-02

5.0 Ah 9212-05

9230-2

9233-7

9212-03





Diagnostika / endoskopická technika

359–360

Lampy/svítlidla

361–366

Pracovní podložky pro mechaniky

367

Chrániče vozidel

367

Mazací technika

368–372

Všeobecné dílenské potřeby

372

Ochrana při práci

373



Inovativní bezdrátové nabíjení

Nabíjení přiložením – bezdrátové nabíjení

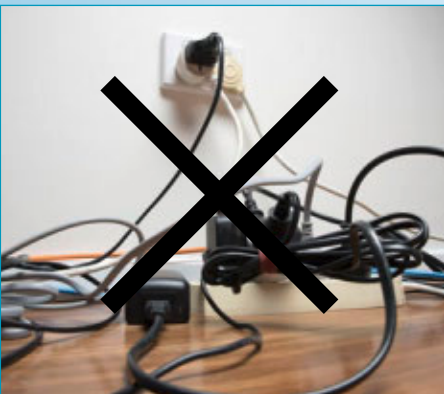

Nepřekáží žádné kabely

Bezdrátové nabíjení zvyšuje bezpečnost tím, že je eliminováno zakopnutí o různé nabíjecí kabely. Vaše dílna bude působit uspořádanějším a uklizenějším dojmem, když budou omezeny „překážející kabely“.

Stejný nabíjecí výkon jako u obvyklého nabíjení přes kabel

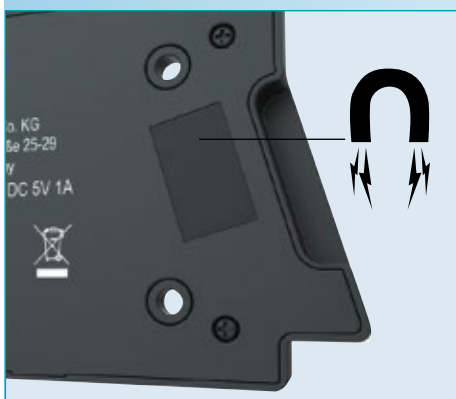

Magnetický držák

Magnetické držáky umožňují flexibilní umístění na magnetické povrchy. Podklad, na kterém je umístěn pad, nebude poškozen šrouby apod.



Samočinné umístění

Samočinné umístění nabízí spolehlivé a snadné umístění lampy. Tímto způsobem se zabrání tomu, že svítidlo se nenabíjí z důvodu chybného umístění.



Přídavný nabíjecí zdroj

Nabíjecí pady HAZET nabízejí kromě bezdrátového nabíjení také klasický způsob. Na spodní straně padu je výstup USB, který umožňuje zastrčení kabelů.



Prvotřídní světlo – Pro prvotřídní práci:
LED pracovní zářič



1979 F-01



Zásuvka 1x nebo 2x 230 V
(podle modelu)



Magnetický držák



Stojan,
90° nastavitelný





		Světelný tok 100%	Doba svícení 100%	Stupeň krytí (IP)	Druh krytí (IK)	Označení baterie / akumulátoru	Zdroj el. proudu	LED technika
	1979 N-71	130 lm	4 h	IP54	IK07	2x 1,5 V micro / AAA / (L)R03	Baterie	SMD
	1979 N-72	200 lm	4,5 h	IP54	IK07	3x 1,5 V micro / AAA / (L)R03	Baterie	SMD
	1979-11	200 lm	2,5 h	IP65	IK09	1050 mAh lithium-iontový akumulátor	USB kabel (USB C)	COB/SMD
	1979 N-82	300 lm	2 h	IP65	IK09	3,7 V 1200 mAh lithium-iontový akumulátor	USB kabel (USB C)	COB/SMD
	1979-91	1000 lm	1,5 h	IP65	IK08	3,7 V 2600 mAh lithium-iontový akumulátor	USB kabel (USB C)	COB/SMD
	1979 W-11	200 lm	2,5 h	IP65	IK09	1050 mAh lithium-iontový akumulátor	Bezdrátové nabíjení	COB/SMD
	1979 W-82	300 lm	2 h	IP65	IK09	3,7 V 1200 mAh lithium-iontový akumulátor	Bezdrátové nabíjení	COB/SMD
	1979 W-91	1000 lm	1,5 h	IP65	IK08	3,7 V 2600 mAh lithium-iontový akumulátor	Bezdrátové nabíjení	COB/SMD
	1979 W-11/3	200 lm	2,5 h	IP65	IK09	1050 mAh lithium-iontový akumulátor	Bezdrátové nabíjení	COB/SMD
	1979 N W/3	300 lm 200 lm	2 h 2,5 h	IP65 IP65	IK09 IK09	3,7 V 1200 mAh 1050 mAh lithium-iontový akumulátor	Bezdrátové nabíjení	COB/SMD
	1979 W/3	300 lm 1000 lm	2 h 1,5 h	IP65 IP65	IK09 IK09	3,7 V 1200 mAh 3,7 V 2600 mAh lithium-iontový akumulátor	Bezdrátové nabíjení	COB/SMD
	1979 WP-1						USB kabel (USB C)	
	1979 WP-2						USB kabel (USB C)	
	1979 FC-40	4000 lm		IP54	IK07		230 V ochranná kontaktní zástrčka	COB
	1979 FC-60	6000 lm		IP54	IK07		230 V ochranná kontaktní zástrčka	SMD



Diagnostika / endoskopická technika

4812 Videoendoskop

• Mikroobjektiv o \varnothing 4,9 mm

- Funkce přepínání směru pohledu $90^\circ + 0^\circ$
- Okamžité přehrání filmu nebo nasnímaných fotografií na TFT-monitoru
- Datum a čas lze skrývat
- Automatické vypnutí pro úsporu energie
- Rozlišení: 640x480 pixelů
- Vylepšené připojení mezi sondou a krytem (kovový) adaptér pro použití starých sond: 4812-20
- Ovládání jednou rukou

Sonda 2. generace:

- Lepší osvětlení s funkcí 90°
- Zlepšený světelný tok LED
- Zjednodušená obsluha
- Zlepšená kvalita opláštění sondy

Rozsah dodávky

- 1m kabel sondy s mikroobjektivem o \varnothing 4,9 mm a LED světelnými zdroji
- Ovládací konzole
- Hák včetně magnetu
- SD-karta 4 GB
- 4x AA baterie



YouTube Clip



HAZET No.		EAN-No. 4000896+	€
4812-10/4 S	4	181742	900,-

4812 N Videoendoskop

• Otočná sonda

- Rozsah otáčení: $1 \times 180^\circ$
- Hlava kamery dlouhá jen 11 mm (-50 % oproti obvyklému provedení), tím je otočná v nejužším prostoru
- Poloměr otočení jen cca 35 mm (-30 % oproti obvyklému provedení)
- Zešílení světla a integrované omezení odrazů
- Světelný zdroj: 5 tlumitelné LED pro optimální osvětlení
- $4 \times 90^\circ$ otočení obrazu stisknutím tlačítka (není nutné otáčení sondy)
- Mikro objektiv: \varnothing 4,5 mm – Front View s rozlišením 640x480 pixelů
- Hloubková ostrost: 10 až 100 mm
- Opláštění z ocelového pleťva
- Kovová přípojka mezi sondou a pouzdem
- Hlava sondy: IP 67
- Automatické vypnutí pro úsporu energie
- Obsah:
 - 1 m kabel sondy s mikro objektivem \varnothing 4,5 mm a světelným zdrojem LED
 - 1 ovládací konzole
 - 1 SD karta 4 GB
 - 4 AA baterie



4812 N Videoendoskop



HAZET No.		EAN-No. 4000896+	€
4812 N-10/3 AF	3	219131	1366,-

4812 Videoendoskopická sonda

- Sondy s vylepšenou přípojkou (4812 N) ve spojení s konzolami sad 4812-10/4 S · 4812-1/7 · 4812-1/6 · 4812-1/8
- Ke spojení se staršími konzolami použijte prosím adaptér 4812-30
- Rozlišení kamery: 325 (H) x 250 (V) = 76800 obrazových bodů
- Úhel otevření kamery: horizontálně 46° , vertikálně: 34° , diagonálně: 56°
- Hloubková ostrost: 10 až 60 mm
- Délka sondy: 1000 mm
- Hmotnost: 220 g



HAZET No.	l mm	\varnothing mm	EAN-No. 4000896+	€
• 3,9 mm \varnothing				
• Směr snímání kamery: 90° – pevně instalované zrcátko (Side-View) Obraz bez okrajů				
• Zdroj světla: 2 stmívatelné LED ve směru 90° Bez odrazů v zrcátku				
• Teplotní rozsah: $0^\circ\text{C} - 55^\circ\text{C}$				
4812 N-1 S	1000	3,9	187102	516,-
• 3,9 mm \varnothing				
• Směr snímání kamery: rovně (Front-View)				
• Zdroj světla: 3 stmívatelné LED				
• Teplotní rozsah: $0^\circ\text{C} - 55^\circ\text{C}$				
4812 N-1 F	1000	3,9	187096	516,-
• 5,5 mm \varnothing				
• Směr snímání kamery: rovně (Front-View)				
• Zdroj světla: 4 stmívatelné LED				
• Teplotní rozsah: $0^\circ\text{C} - 55^\circ\text{C}$				
4812 N-5.5	1000	5,5	187065	499,-
• 4,9 mm \varnothing				
• Přepínací funkce úhlu snímání: $90^\circ + 0^\circ$				
• Stmívatelné LED				
• Kovová přípojka				
• Teplotní rozsah: $0^\circ\text{C} - 55^\circ\text{C}$				
4812-16	1000	4,9	181841	572,-



4812 Endoskopická sonda



HAZET No.	Ø mm	EAN-No. 4000896+	€
4812 N-2 AF	4,5	218868	1022,-

- 4,5 mm Ø mikro objektiv
- 1 m kabel sondy
- LED světelný zdroj
- Stupeň krytí sonda: IP67 · rukojeť: IP57

2151 Stetoskop

Made in Germany

- Přenosová membrána

- Ocelový hrot 180 mm



HAZET No.	l mm	EAN-No. 4000896+	€
2151	1080	013043	80,90
2151-02/2	-	062287	14,40

- Ušní olivky pro stetoskop HAZET 2151

1991 Infračervený teploměr

- Pro bezdotykové měření teploty. S integrovaným laserovým ukazovátkem

- Rozmanité oblasti použití, mj. v oblasti motorových vozidel (chladiče/chladič systémy, brzdy, klimatizace, motor, výfukový systém), kontrola v chemickém a potravinářském průmyslu, ve výrobě topných zařízení a klimatizací

- Funkce rychlé identifikace
- Precizní, bezdotykové měření
- Funkce automatického podržení naměřené hodnoty
- Zobrazení maximální teploty, blokování spuštění
- 9V bloková baterie (6LR61)
- Přídavné podsvícení displeje
- Detekce cíle s dvojitým laserem
- D : S = 12 : 1
- Emisivita nastavitelná od 0,1 do 1,0
- Volitelné nastavení na hlasitý nebo tichý alarm
- V koženkové tašce na suchý zip a s poučkem
- Teplotní rozsah: -50°C – 550°C



360°

HAZET No.	EAN-No. 4000896+	€
1991-1	156054	135,20

1977 Sada teleskopických zrcátek

- Teleskopická tyč s pružně uloženým dvojitým kloubem
- Zrcátko vyměnitelné přes 4 mm nerezovou závitovou tyč s pravým zrcátkem
- Bez zašpinění zrcátka jako u leštěných „kovových zrcátek“
- Zrcadlové sklo bezpečně chráněno nerezovým krytem

4dílná sada, obsah:

teleskopická tyč, výsuvná délka: 300–740 mm

kulaté zrcátko: 30 mm Ø

kulaté zrcátko: 50 mm Ø

hranaté zrcátko: 65x43 mm



HAZET No.	l ₁ mm	l ₂ mm	EAN-No. 4000896+	€
1977-2/4	300	740	150144	56,95

1975 Drapák

- Pružný

- Povrch: chromováno



HAZET No.	l mm	EAN-No. 4000896+	€
1975	540	009725	47,85

1976 Magnetický hledač

Made in Germany

- Permanentní magnet
- Ohebná hřídel
- Plastová rukojeť



HAZET No.	l mm	Ø mm	q P	EAN-No. 4000896+	€
1976	545	15	4500	009732	42,70
1976-1	545	19	7500	009749	66,80
1976-2	475	8	1100	009763	38,25



Lampy/svítidla

1979 LED tužková svítidla

• Díky vysoce účinnému reflektorovému systému je dosahováno využití světelného zdroje až 130 lumenů a dosahu světla až 75 metrů

- Vylepšené provedení: cca o 100% jasnější cca o 40% delší doba svícení
- Profesionální tužková svítidla zajišťuje vyváženými proporcemi pouzdra a drsným povrchem vždy optimální manipulaci
- Ovládání vypínače je díky dobrému umístění bez problémů možné i s rukavicemi
- Mimořádně robustní eloxované hliníkové pouzdro chrání vnitřní díly před vniknutím prachu a stříkající vody (IP54)
- 3 Watt LED
- Hliník, černě eloxovaný
- Hmotnost: 100 g
- Včetně prodejního stojanu při odběru nejméně 12 kusů
- Počet baterií/akumulátorů: 2 x 1,5 V-Micro / AAA / (L)R03
- Napájení el. proudem: Baterie
- LED technika: SMD
- Světelný tok 100 %: 130 lm
- Doba svícení 100 %: 4 h
- Dosah světla: 75 m
- Stupeň krytí (IP): IP54
- Druh krytí (IK): IK07

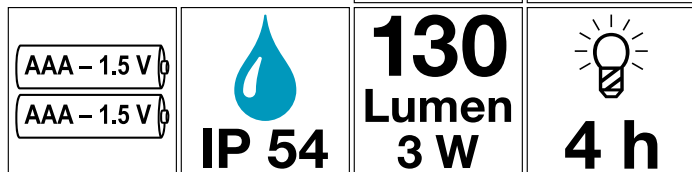

HAZET No.	l / mm	EAN-No. 4000896+	€
1979 N-71	139	208470	21,80

1979 LED kapesní svítidla · malé provedení

• Plynulé jednoruční zaostřování umožňuje přesný světelný bod až po homogenní umělé osvětlení

- Vylepšené provedení: – možnost nastavení – cca o 33% vyšší jas
- Profesionální tužková svítidla v malém provedení zajišťuje vyváženými proporcemi pouzdra a drsným povrchem vždy optimální manipulaci
- Stablní konstrukce chrání proti prachu a stříkající vodě (IP54)
- Nárazuvzdorná do výšky pádu 1 m
- 3 Watt LED
- 2 stupně svítivosti: 30% a 100% (regulovatelné vypínačem Zap / Vyp.)
- Dosah světla při 30%: 100 m
- Doba svícení při 30% (režim úspory energie) do max. 13 h
- Světelný tok při 30%: (režim úspory energie) 80 lumenů
- Včetně praktického poutka k nošení
- Včetně prodejního stojanu při odběru nejméně 8 kusů
- Počet baterií/akumulátorů: 3 x 1,5 V-Micro / AAA / (L)R03
- Napájení el. proudem: Baterie
- LED technika: SMD
- Světelný tok 100 %: 200 lm
- Doba svícení 100 %: 4,5 h
- Dosah světla: 175 m
- Stupeň krytí (IP): IP54
- Druh krytí (IK): IK07



1979 LED kapesní svítidla · malé provedení

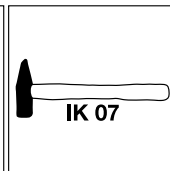
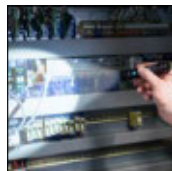

100%
200 Lumen
30%
80 Lumen

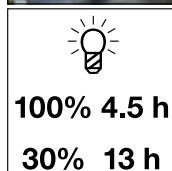

HAZET No.	l / mm	EAN-No. 4000896+	€
1979 N-72	135	208487	42,20

1979 LED tužková svítidla

• USB-C nabíjecí zdička

- Malá kompaktní svítidla LED s vysokým světelným výkonem
- Plynulé strmivání - optimální přizpůsobení světla
- Snadná a rychlá diagnostika pomocí hlavního světla (plošné osvětlení) nebo top světla (bodové osvětlení) m. j. k přijetí dialogu
- Neměla by chybět v žádné výbavě odborníka
- 2složkové plastové pouzdro s pogumovaným povrchem
- Zobrazení stavu baterie a nabití
- Zapnutí / vypnutí a také přechod mezi Top a hlavním světlem pomocí hlavního tlačítka
- Včetně 100 cm USB-C nabíjecího kabelu
- Kapacita akumulátoru: 1050 mAh
- Výsuvný přídržný klip
- Zobrazení stavu nabití baterie
- Doba svícení top světlo: 2.5 h
- Světelný tok top světlo: 120 lm
- Silně integrované přídržné magnety na zadní straně krytu
- Napájení el. proudem: USB kabel (USB C)
- LED technika: COB/SMD
- Světelný tok 100 %: 200 lm
- Doba svícení 100 %: 2,5 h
- Doba nabíjení: 2 h
- Stupeň krytí (IP): IP65
- Druh krytí (IK): IK09

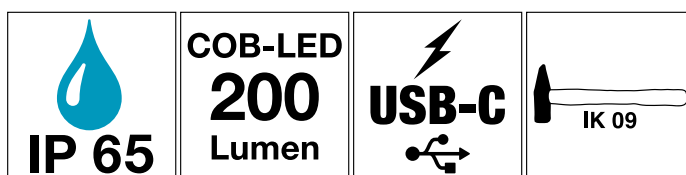

HAZET No.	l / mm	EAN-No. 4000896+	€
1979-11	180	235254	27,05



1979 LED kapselní svítilna

• **K nastavení osvětlení pracovní oblasti lze stojan nastavovat o 180° a aretovat v 8 stupních**

- 2složkové plastové pouzdro s pogumovaným povrchem
- Plynulé stmívání - optimální přizpůsobení světla
- 4-stupňové zobrazení stavu baterie a nabití
- Zapnutí / vypnutí a také přechod mezi Top a hlavním světlem pomocí hlavního tlačítka
- Silný přídržný magnet potažený pryží na spodní straně.
- 360° pohyblivý hákový držák
- Odolnost proti nárazům (EN62262): IK09

• **Hlavní světlo:**
doba svícení: 2 – 10 h
světelný tok 30 – 300 lumenů
3 wattů COB LED

• **Top světlo:**
doba svícení 5 h
světelný tok: 100 lumenů

- Včetně 100 cm USB-C nabíjecího kabelu (bez síťového zdroje USB)
- Možnost nabíjení přes standardní síťový zdroj USB 5 V maximálně 1 A
- Napájení el. proudem: USB kabel (USB C)
- LED technika: COB/SMD
- Světelný tok 100 %: 300 lm
- Doba svícení 100 %: 2 h
- Doba nabíjení: 1,5
- Stupeň krytí (IP): IP65
- Druh krytí (IK): IK09



YouTube Clip

100%
300
Lumen

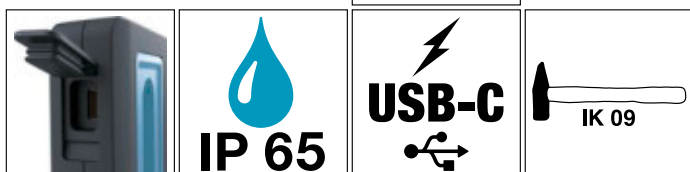
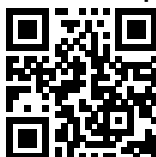

HAZET No.	l mm	EAN-No. 4000896+	€
1979 N-82	133	227211	56,90

1979 LED tenká svítilna

• **K nastavení osvětlení pracovní oblasti lze hlavici nastavovat o 120° a aretovat v 5 stupních**

- 2složkové plastové pouzdro s pogumovaným povrchem
- Velkoplošné, homogenní prosvícení
- Tlumič přepínač na zadní straně svítilny – optimální přizpůsobení světla
- 4-stupňové zobrazení stavu baterie a nabití
- Zapnutí / vypnutí a také přechod mezi Top a hlavním světlem pomocí hlavního tlačítka
- Silný přídržný magnet potažený pryží na spodní straně.
- Výklopný hákový držák otočný o 360°
- Hliníkový horní díl
- Solidní stojan pro dobré postavení také na nekovových podkladech

• **Hlavní světlo:**
doba svícení 1,5–8 h
světelný tok 100–1000 lumenů
10 wattů COB LED

• **Top světlo:**
doba svícení 6 h
světelný tok 150 lumenů
3 wattů SMD LED Top světlo

- Možnost nabíjení / napájení proudem přes USB-C zdířku 5 V, maximálně 1 A
- Včetně 100 cm USB-C nabíjecího kabelu (bez síťového zdroje USB)
- Napájení el. proudem: USB kabel (USB C)
- LED technika: COB/SMD
- Světelný tok 100 %: 1000 lm
- Doba svícení 100 %: 1,5 h
- Doba nabíjení: 3,5 h
- Stupeň krytí (IP): IP65
- Druh krytí (IK): IK08



1979 LED tenká svítilna

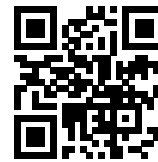
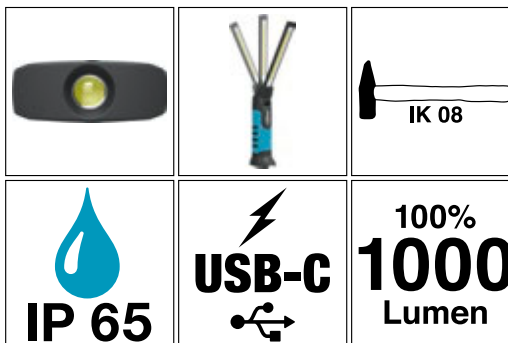

YouTube Clip

HAZET No.	l mm	EAN-No. 4000896+	€
1979-91	365	222452	89,30

1979 LED tužková svítilna - bezdrátová

- **Inovativní bezdrátové nabíjení**
- **Efektivní a komfortní funkce nabíjení díky optimalizovanému samočinnému umístění svítilny na padu**

- Malá kompaktní svítilna LED s vysokým světelným výkonem
- Plynulé stmívání - optimální přizpůsobení světla
- Snadná a rychlá diagnostika pomocí hlavního světla (plošné osvětlení) nebo top světla (bodové osvětlení) m. j. k přijetí dialogu
- Neměla by chybět v žádné výbavě odborníka
- Nabíjení začne hned po přiložení svítilny
- 2složkové plastové pouzdro s pogumovaným povrchem
- Zobrazení stavu baterie a nabití
- Zapnutí / vypnutí a také přechod mezi Top a hlavním světlem pomocí hlavního tlačítka
- Je potřeba pad k bezdrátovému nabíjení 1979 WP-1 nebo 1979 WP-2
- Kapacita akumulátoru: 1050 mAh
- Výsuvný přídržný klip
- Zobrazení stavu nabití baterie
- Doba svícení top světlo: 2,5 h
- Světelný tok top světlo: 120 lm
- Silně integrované přídržné magnety na zadní straně krytu
- Napájení el. proudem: Bezdrátové nabíjení
- LED technika: COB/SMD
- Světelný tok 100 %: 200 lm
- Doba svícení 100 %: 2,5 h
- Doba nabíjení: 2,5 h
- Stupeň krytí (IP): IP65
- Druh krytí (IK): IK09



HAZET No.	l mm	EAN-No. 4000896+	€
1979 W-11	180	235230	32,10



1979 LED kapsní svítilna · bezdrátové nabíjení

- **Inovativní bezdrátové nabíjení**
- **Efektivní a komfortní funkce nabíjení díky optimalizovanému samočinnému umístění svítilny na padu**
- Nabíjení začne hned po přiložení svítilny
- 2složkové plastové pouzdro s pogumovaným povrchem
- 4-stupňové zobrazení stavu baterie a nabití
- Zapnutí / vypnutí a také přechod mezi Top a hlavním světlem pomocí hlavního tlačítka
- Napájení el. proudem: Bezdrátové nabíjení
- LED technika: COB/SMD
- Světelný tok 100 %: 300 lm
- Doba svícení 100 %: 2 h
- Doba nabíjení: 1,5 h
- Stupeň krytí (IP): IP65
- Druh krytí (IK): IK09
- K nastavení osvětlení pracovní oblasti lze stojan nastavovat o 180° a aretovat v 8 stupních
- Plynulé stmívání - optimální přizpůsobení světla
- Silné přídržné magnety potažené pryží na spodní a zadní straně krytu
- 360° pohyblivý hákový držák
- **Hlavní světlo:**
doba svícení 2–10 h
světelný tok 30–300 lumenů
3 wattů COB LED
- **Top světlo:**
doba svícení Top světlo: 5 h
světelný tok 100 lumenů
1 watt LED

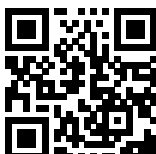

YouTube Clip

1979 LED tenká svítilna · bezdrátové nabíjení

- **Inovativní bezdrátové nabíjení**
- **Efektivní a komfortní funkce nabíjení díky optimalizovanému samočinnému umístění svítilny na padu**
- Nabíjení začne hned po přiložení svítilny
- 2složkové plastové pouzdro s pogumovaným povrchem
- 4-stupňové zobrazení stavu baterie a nabití
- Zapnutí / vypnutí a také přechod mezi Top a hlavním světlem pomocí hlavního tlačítka
- Napájení el. proudem: Bezdrátové nabíjení
- LED technika: COB/SMD
- Světelný tok 100 %: 1000 lm
- Doba svícení 100 %: 1,5 h
- Doba nabíjení: 3,5 h
- Stupeň krytí (IP): IP65
- Druh krytí (IK): IK08
- Velkoplošné, homogenní prosvícení
- Tlumicí přepínač na zadní straně svítilny umožňuje optimální přizpůsobení světla
- 4-stupňové zobrazení stavu baterie a nabití
- Silný přídržný magnet potažený pryží na spodní straně.
- Výklopný hákový držák otočný o 360°
- Hliníkový horní díl
- Solidní stojan zajistí dobré postavení také na nekovových podkladech
- **Hlavní světlo:**
doba svícení 1,5–8 h
světelný tok 100–1000 lumenů
10 wattů COB LED
- **Top světlo:**
doba svícení Top světlo: 6 h
Top světlo: 150 lumenů
3 wattů SMD LED

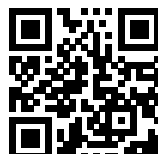

YouTube Clip

	 IP 65	 IK 09	100% 300 Lumen

	 IP 65	 IK 08	100% 300 Lumen

HAZET No.	l mm	EAN-No. 4000896+	€
1979 W-82	133	227228	68,80

HAZET No.	l mm	EAN-No. 4000896+	€
1979 W-91	365	227938	79,40





1979 Sada LED tužkových svítilen

- Inovativní bezdrátové nabíjení
- Efektivní a komfortní funkce nabíjení díky optimalizovanému samočinnému umístění svítilny na padu
- Malá, kompaktní svítilna LED s vysokým světelným výkonem
- Plynulé stmívání - optimální přizpůsobení světla
- Snadná a rychlá diagnostika pomocí hlavního světla (plošné osvětlení) nebo top světla (bodové osvětlení) m. j. k přijetí dialogu
- Neměla by chybět v žádné výbavě odborníka
- Nabíjení začne hned po přiložení svítilny
- 2složkové plastové pouzdro s pogumovaným povrchem
- Zobrazení stavu baterie a nabití
- Zapnutí / vypnutí a také přechod mezi Top a hlavním světlem pomocí hlavního tlačítka
- Pen light pro denní použití v nejrůznějších oblastech použití
- Sad LED Pen light, 3dílná
- Obsah:
 - 2x 1979 W-11 LED tužková svítilna · bezdrátová
 - 1x 1979 WP-2 Duální pad k bezdrátovému nabíjení
 - 1x 100 cm USB-C kabel
 - 1x 5 V, 2 A síťový zdroj
- Napájení el. proudem: Bezdrátové nabíjení
- Stupeň krytí (IP): IP65
- Druh krytí (IK): IK09

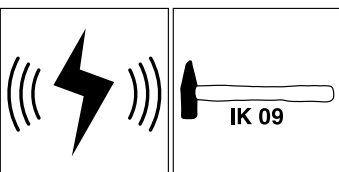

HAZET No.	EAN-No. 4000896+	€
1979 W-11/3	235247	112,-

1979 Sada LED inspekčních svítilen

- Inovativní bezdrátové nabíjení
- Efektivní a komfortní funkce nabíjení díky optimalizovanému samočinnému umístění svítilny na padu
- Malá, kompaktní svítilna LED s vysokým světelným výkonem
- Plynulé stmívání - optimální přizpůsobení světla
- Snadná a rychlá diagnostika pomocí hlavního světla (plošné osvětlení) nebo top světla (bodové osvětlení) m. j. k přijetí dialogu
- Neměla by chybět v žádné výbavě odborníka
- Nabíjení začne hned po přiložení svítilny
- 2složkové plastové pouzdro s pogumovaným povrchem
- Zobrazení stavu baterie a nabití
- Zapnutí / vypnutí a také přechod mezi Top a hlavním světlem pomocí hlavního tlačítka
- Sada LED svítilen, 3 dílná
- Obsah:
 - 1x 1979 W-11 LED tužková svítilna · bezdrátová
 - 1x 1979 W-82 LED kapesní svítilna · bezdrátové nabíjení
 - 1x 1979 WP-2 Duální pad k bezdrátovému nabíjení
 - 1x 100 cm USB-C kabel
 - 1x 5 V, 2 A síťový zdroj
- Napájení el. proudem: Bezdrátové nabíjení
- Stupeň krytí (IP): IP65
- Druh krytí (IK): IK09

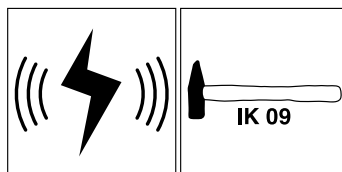

HAZET No.	EAN-No. 4000896+	€
1979 N W/3	235261	146,70





1979 Sada LED svítlen

- **Inovativní bezdrátové nabíjení**
- **Efektivní a komfortní funkce nabíjení díky optimalizovanému samočinnému umístění svítilny na padu**
- Nabíjení začne hned po přiložení svítilny
- 2složkové plastové pouzdro s pogumovaným povrchem
- 4-stupňové zobrazení stavu baterie a nabití
- Zapnutí / vypnutí a také přechod mezi Top a hlavním světlem pomocí hlavního tlačítka
- Sada LED svítlen, 3 dílná
- 1x 1979 W-82 LED kapsesní svítilna
- 1x 1979 W-91 LED tenká svítilna
- 1x 1979 WP-2 nabíjecí pad pro 2 svítilny
- 1x USB-C kabel, 100 cm
- 1x 5 V, 2 A síťový zdroj
- Napájení el. proudem: Bezdrátové nabíjení
- LED technika: COB/SMD
- Stupeň krytí (IP): IP65



YouTube Clip



HAZET No.		EAN-No. 4000896+	€
1979 W/3	3	227969	169,40

1979 Pad k bezdrátovému nabíjení

- **Přídavný výstup USB k nabíjení dalších přístrojů**
- Přídružné magnety na zadní straně padu k připevnění na magnetických podkladech
- 4 otvory pro šrouby
- Včetně 100 cm USB-C kabelu (bez síťového zdroje USB)
- 5 V USB-C vstup
- Možnost nabíjení přes pad nebo výstup USB
- Napájení el. proudem: USB kabel (USB C)



1979 Pad k bezdrátovému nabíjení



YouTube Clip



HAZET No.	EAN-No. 4000896+	€
<ul style="list-style-type: none"> • Maximální výstupní proud bezdrátový: 850 mA • Optimalizované samočinné umístění jedné svítilny na padu • 1 A nabíjecí proud 1979 WP-1	227952	37,05
<ul style="list-style-type: none"> • Maximální výstupní proud bezdrátový: 1700 mA • Optimalizované samočinné umístění dvou svítlen na padu • 2 A nabíjecí proud 1979 WP-2	227945	52,95

1979 LED pracovní zářič

- **40 watt energeticky efektivní technologie COB LED k rovnoměrnému osvětlení prostoru**
- Otočný spínač intenzity světla k plynulému nastavení
- Rozšíření funkčnosti díky přídavné zásuvce 230V na zadní straně umožňuje připojení a provoz libovolných dalších přístrojů
- 50 % výkonu okamžitě při zapnutí
- Robustní PU kryt s hliníkovými komponentami po obvodu k lepšímu odvodu tepla
- Vizuální zobrazení výkonu: 4-stupňové
- Stojan: nastavitelný o 90°
- Délka kabelu: 5 m
- Odolnost proti nárazům (EN62262): IK07
- Lze rozšířit o:
 - 1979 F-01 difuzér
 - 1979 F-02 přídružný magnet
 - 1979 F-03 teleskopický stojan
- Napájení el. proudem: 230 V zástrčka s ochranným kontaktem
- LED technika: COB
- Světelný tok 100 %: 4000 lm
- Stupeň krytí (IP): IP54
- Druh krytí (IK): IK07
- Světelný tok: 400 – 4000 lumenů
- 1 rozšiřovací zásuvka na zadní straně

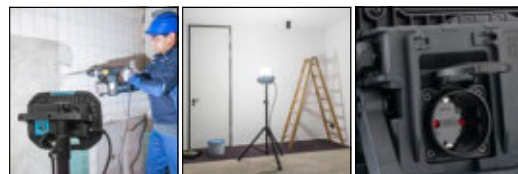

YouTube Clip



HAZET No.	l mm	EAN-No. 4000896+	€
1979 FC-40	280	227839	127,-



1979 LED pracovní zářič

- 60 watt energeticky efektivní technologie SMD LED k rovnoměrnému osvětlení prostoru
- Otočný spínač intenzity světla k plynulému nastavení
- Rozšíření funkčnosti díky přídatné zásuvce 230V na zadní straně umožňuje připojení a provoz libovolných dalších přístrojů
- 50 % výkonu okamžitě při zapnutí
- Robustní PU kryt s hliníkovými komponentami po obvodu k lepšímu odvodu tepla
- Vizuální zobrazení výkonu: 4-stupňové
- Stojan: nastavitelný o 90°
- Délka kabelu: 5 m
- Odolnost proti nárazům (EN62262): IK07
- Lze rozšířit o:
 - 1979 F-01 difuzér
 - 1979 F-02 přídržný magnet
 - 1979 F-03 teleskopický stojan
- Napájení el. proudem: 230 V zástrčka s ochranným kontaktem
- LED technika: SMD
- Světelný tok 100 %: 6000 lm
- Stupeň krytí (IP): IP54
- Druh krytí (IK): IK07
- Světelný tok: 600 – 6000 lumenů
- 2 rozšiřovací zásuvky na zadní straně

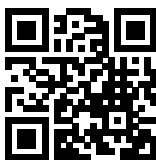

YouTube Clip



IK 07	IP 54	100% 6000 Lumen
-------	-------	------------------------------

HAZET No.	l mm	EAN-No. 4000896+	€
1979 FC-60	360	227822	164,10

1979 Světelný difuzér

- Aretace s bajonetovým uzávěrem
- Maximální světelný tok při použití difuzéru
1979 FC-40: 3200 lumenů
1979 FC-60: 4800 lumenů



1979 Světelný difuzér

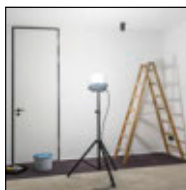

HAZET No.	EAN-No. 4000896+	€
1979 F-01	227815	31,75

1979 Magnetický držák

- Povrstvení magnetu chrání před poškozením podkladů

- Aretace pomocí přiloženého připevňovacího šroubu
- Přídržná síla magnetu maximálně: 10 kg



HAZET No.	EAN-No. 4000896+	€
1979 F-02	227808	48,70

1979 Teleskopický stojan

- Trojnohý stojan umožňuje bezpečné postavení

- Robustní ocelová konstrukce
- Sestavení bez nářadí
- Možnost pevného nastavení noh a výškové aretace
- Přídatná kabelová vedení na stojanu
- Výška 120–185 cm
- Nosnost: 30 kg



HAZET No.	EAN-No. 4000896+	€
1979 F-03	227174	68,80



Pracovní podložky pro mechaniky

195 Podložka pod kolena

Made in Germany

• Ve tvaru loga HAZET

- Ještě vyšší komfort díky nové kvalitě pěny
- Otíratelná
- Nosné/závěsné madlo
- Z nesavé pěny s uzavřenými buňkami



HAZET No.	d x š x v mm	EAN-No. 4000896+	€
195-1	450x210x30	121069	20,15

195 Podložka pro mechaniky

Made in Germany

• Ve tvaru loga HAZET

- Ještě vyšší komfort díky nové kvalitě pěny
- Otíratelná
- Velká podložka pro mechaniky
- Z nesavé pěny s uzavřenými buňkami
- Držadlo



HAZET No.	d x š x v mm	EAN-No. 4000896+	€
195-5	975x385x30	153718	40,25

Chrániče vozidel

196 Chráníč blatníků · univerzální

Made in Germany

• Magnetické uchycení (6 magnetů)

- Optimální ochrana pro vozidla vašich zákazníků
- Zvyšuje kvalitu práce – snižuje nepříjemné opravy a dodatečné úpravy
- Použitelné téměř u všech vozidel



HAZET No.	mm	EAN-No. 4000896+	€
196 N-1	950x670	208258	55,45

196 Chráníč blatníků

• Protiskluzový materiál se speciálním povrchem

- Voděodolný, odpuzuje olej a tuky
- Chráníč drží téměř kompletně visle na všech površích karoserie (hliník, ocel, GFK)
- Odpovídá požární bezpečnosti podle britského standardu a amerického Fed 302
- Lze prát při +40 °C
- Chrání povrch karoserie proti škrábancům a poškození
- Nylonový povrch na přední straně lze snadno čistit a otírat
- Rozměry: 890 x 500 mm
- Materiál: 60% polyester, 30% polyamid/nylon, 10% bavlna



HAZET No.	mm	EAN-No. 4000896+	€
196-2	890x500	149469	29,30

196 Chráníč čela

• I pro práci při běžícím motoru

- Voděodolný, odpuzuje olej a tuky
- Chráníč odpovídá požární bezpečnosti podle britského standardu a amerického Fed 302
- Snadné čištění
- Upevnění pomocí poutek
- Výřezy pro osvětlení a chladič
- Materiál: 98% polyamid/nylon, 2% polyuretan



HAZET No.	EAN-No. 4000896+	€
196-3	149414	253,30

196 Potah sedadla a volantu

• Vhodný pro téměř všechny autosedačky a volanty

- Univerzální velikost
- Opakovaně použitelný
- Dlouhá životnost
- Voděodolný, odpuzuje olej a tuky
- Chráníč odpovídá britským požárním normám a americkému Fed 302
- Testováno pro boční airbagy
- Antistatické
- Pratelný při +40 °C
- Z odolné nylonové tkaniny s gumou kolem dokola
- Lze snadno čistit
- Necitlivá černá barva s vyztuženým okrajem (HAZET modrá)
- Materiál: 98% polyamid/nylon, 2% polyuretan



HAZET No.	ks	EAN-No. 4000896+	€
196-6/2	2	150151	44,60



Mazací technika

197 Magnetická miska

- Uložení malých dílů, např. šroubů atd.
- Plast
- Magnet k upevnění, např. na díleenský vozík, stěny dílny, zdvihací plošiny atd.



360°



HAZET No.	Ø mm	EAN-No. 4000896+	€
197-3	150	158584	10,95

197 Vana, víceúčelová

- Pro výměnu oleje / olejového filtru a k čištění dílů



- Bezpečné a čisté vylévání díky přelivovému okraji kolem dokola
- Z polyetylenu (nerozbitná)
- Stupnice na vnitřní straně: litry, US galony / UK galony
Dělení stupnice: 1 l / 1 gal
- 3 držáky
- S výlevkou
- Vyvýšení k odkládání dílů, včetně zajištění filtru (proti skluzu)
- Možnost odkapávání olejového filtru
- Vany lze skládat do sebe
- Rozměry d x š x v: 400 x 390 x 120 mm
- Vyrobeno v EU

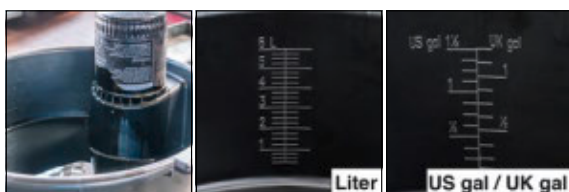

HAZET No.	l	EAN-No. 4000896+	€
197 N-1	6	198924	12,-

- Pro výměnu oleje / olejového filtru a k čištění dílů



- Bezpečné a čisté vylévání díky přelivovému okraji kolem dokola
- Z polyetylenu (nerozbitná)
- Vylévací kohout pro bezpečné a čisté vylévání kapalin
- Tři držáky pro snadné přenášení a vylévání



197 Vana, víceúčelová

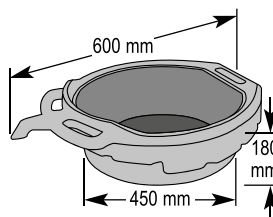

HAZET No.	l	EAN-No. 4000896+	€
197-2	16	146802	40,35

Made in Germany



- Univerzálně použitelná
- Velká kapacita

Použití: Použitelná jako čistící vana, odpadní vana, olejová vana, skladovací vana, dezinfekční vana, odkapávací vana, přepravní vana a zásobovací vana, např. při stavbě sanity a topení, v automobilovém průmyslu a v dílně, v loveckých potřebách, chemii / laboratoři, v potravinářském průmyslu / řeznictví, při sportovním rybaření, v chovatelských potřebách, při chovu koní atd.

- Odolná vůči louhům a kyselinám
- Objem: 50 l
- Vnitřní rozměry (š x h x v): 800 x 520 x 100 mm
- Z výroby certifikované TÜV podle DIN ISO 16901



HAZET No.	l	EAN-No. 4000896+	€
197-50	50	210008	53,05

- Vůči chemikáliím odolný, nerozlomitelný plast s hladkým povrchem odolným proti oděru



HAZET No.	l	EAN-No. 4000896+	€
197-4	3	214235	19,25



198-1 Trychtýř s ohebnou hadicí

- Plnění všech obvyklých díleenských kapalin, např. olejů, paliv nebo brzdových kapalin
- Trychtýř z polypropylenu, hadice z polyetylenu, sítko trychtýře z ušlechtilé oceli
- Průměr trychtýře: 165 mm
- Délka včetně hadice: 480 mm



HAZET No.	EAN-No. 4000896+	€
198-1	149155	12,35

199 Postřiková láhev · opakovaně plnitelná

- Použití s multifunkčními spreji, např. mazacími oleji, rozpouštěči rzi a čistíci brzd



- Úspora nákladů díky využití velkých balení
- Pojistný ventil
- Max. provozní tlak: 8 barů
- Těsnění Viton
- Včetně 155 mm dlouhé proudové trysky a krátké rozprašovací trysky
- Rozprašování mlhy a bodové tryskání
- Snadné čištění díky dvoudílné konstrukci
- Snadné plnění hrdlem lahve (Ø 25 mm) nebo přes spodní díl (Ø 54 mm)
- Ekologické: bez freonů a opětovně použitelné
- Ventil umístěný ve dně slouží výhradně k naplnění stlačeným vzduchem

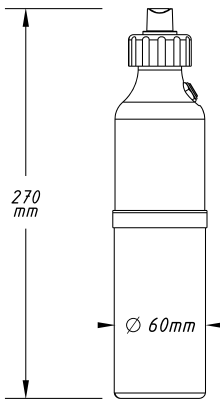

YouTube Clip



HAZET No.	l	EAN-No. 4000896+	€
199-4	0,227	198429	60,65

198 Odměrka

- Brzdové kapaliny, elektrolyt akumulátorů a nekyselé kapaliny
- Materiál: HDPE
- Barva: bílá/transparentní



HAZET No.	l	EAN-No. 4000896+	€
198-4	1	174485	8,-
198-5	2	174478	10,65
198-6	5	174522	17,25
198-8	5	174508	15,90

2160 Stříkací olejnička



HAZET No.	l mm	l	EAN-No. 4000896+	€
2160	245	0,2	013289	28,-

2162 Mazací lis

- Kapacita: 500 cm³
- Pancéřová hadice, trysková trubka a 2 hubice M 10 x 1



2162-1

360°

HAZET No.	EAN-No. 4000896+	€
2162-1	075027	57,20
2162-2	075034	73,10



2162 Výkonná sací a tlaková plnička

- Přebytečný materiál může být opět bez problémů nasát zpět
- Flexibilní odtok plastovou hadicí
- Materiál tělesa: ocel, pozinkováno



2162-6

HAZET No.	l	EAN-No. 4000896+	€
• Objem náplně: 500 ml			
• Hadice s vnitřním průměrem: 9,5 mm			
• Hadice s vnějším průměrem: 12,5 mm			
• Těsnění NBR			
• Pro motorové oleje s viskozitou od 30 do 68			
• Není vhodné pro kyselá (erozivní) kapaliny			
2162-4	0,5	174850	15,65
• Kromě toho včetně kovového vývodu			
• Objem náplně: 1000 ml			
• Hadice s vnitřním průměrem: 9,5 mm			
• Hadice s vnějším průměrem: 12,5 mm			
• Těsnění NBR			
• Pro motorové oleje s viskozitou od 30 do 68			
• Není vhodné pro kyselá (erozivní) kapaliny			
• Připojovací závit (hadice/trubka) na dně pumpy: 12,7 mm (1/2") PT x 19			
2162-6	1	174454	29,35

2162 Ruční přečerpávací / plnicí čerpadlo

Made in Germany

- 600 ml objem čerpadla umožňuje rychlé přečerpávání a plnění kapalin mezi různými nádobami

- Použití: Plnění, přečerpávání a naplňování kapalin
- Základní deska a dvojitá přípojka pro hadice s vnitřním Ø 10/ 15 mm
- 1 sací hadice, délka: 3 m
- 1 tlaková hadice, délka: 3 m
- Např. na **MERCEDES-BENZ** Citaro Euro 6 ve spojení s trubkou chladicí vody 2xA.311.500.09.91 a spojovacím hrdlem A.001.553.19.26 a spojovací zástrčkou A.001.553.20.26
- Pevodové a motorové oleje lze s pomocí čerpadla rychle, bez bublinek a čistě naplnit
- Přečerpávané kapaliny např.
 - Ad Blue
 - Chladicí kapaliny
 - Nemrznoucí náplň ostříkovače
 - Olej
 - Voda



HAZET No.	EAN-No. 4000896+	€
2162-7	207756	196,10

2162 Ruční dávkovací pumpa

- Přesné dávkování nejrůznějších kapalin díky dvojitému škálování

- Připojovací závit (hadice/trubka) na dně pumpy: M15 x 1,5
- Materiál pouzdra: PVC (transparentní)
- Hadice vnitřní Ø: 10 mm
- Hadice vnější Ø: 16 mm
- Těsnění NBR
- Přebytečný materiál může být opět bez problémů nasát zpět
- Včetně flexibilní průhledné plastové hadice vyztužené tkaninou
- Včetně zahnuté 120° hliníkové aplikační trubky x 10 mm
- Silná savost a lehký chod
- Délka hadice 600 mm s připočtením aplikační trubky
- Maximální transport. množství 4 l/min
- Délka bez hadice 545 mm



HAZET No.	l	EAN-No. 4000896+	€
2162-8	0,7	213337	128,30

2163 Ruční pumpa s teleskopickou sací trubkou 16 l/min.

Made in Germany

- Vhodné pro 50- až 200litrové sudy
- Kovová teleskopická sací trubka 450 až 860 mm vytažitelná
- Tělo z pozinkované oceli
- R 2" a R 1.1/2" adaptér pro sud
- Odnímatelný, zakřivený kovový výtok
- Dopravní množství: asi 0,35 litru/zdvih
- Hmotnost: 2,2 kg

Pozor: Není vhodné pro čerpání benzínu



HAZET No.	EAN-No. 4000896+	€
2163-1	172771	51,70



2162 Minimaznice

- Objem náplně: 80 g
- Vytváří tlak až do 1.000 PSI / 69 bar
- Plnění s volným tukem
- Včetně tlakové maznice v provedení 50° a 90°



9300 N-60



HAZET No.	l / mm	EAN-No. 4000896+	€
2162 M	145	185634	21,80
<ul style="list-style-type: none"> • Rychlé a čisté naplnění mazacího mini lisu HAZET 2162 M • Zlepšená mechanická stabilita zabraňuje při vibracích okolí ztrátě mazacího výkonu • Odolné proti mytí vodou • Oxidačně stabilní • Dobrá protikorozní ochrana a dobrá přilnavost na kovových plochách • Tukový polštář 60 ml 			
9300 N-60	-	203406	10,20

199 Tlakový postřikovač

- **Zakrytý čerpací mechanismus zvyšuje odolnost proti chemikáliím**

- Pro univerzální použití v oblasti automobilového a jiného průmyslu
- **Čištění/odmaštění obrobků, dílen, vozidel, např. strojů, motorů, podlah, disků atd.**
- **Nanášení olejů a dělicích prostředků** u strojů, obrobků, výhybek a kolejových součástí, ve výrobě forem, u bednění atd.
- **Dezinfekce a čištění** podlah, fasád, sanitárních zařízení, bazénů atd.
- Integrovaný bezpečnostní ventil (2,5 baru) umožňuje odtlakování nádoby před otevřením
- Těsnění Viton
- Těsnění a materiály odolné vůči většině kyselin a rozpouštědel a rovněž proti v průmyslu, technice motorových vozidel a profesionálním čištění nejčastěji používaným chemikáliím
- Nastavitelná kuželová tryska a flexibilní čerpací páčka zabraňuje zlomení
- Přípustný provozní tlak: maximálně 2,5 bar
- Průtok: 0,5 l/min při 2,5 baru s bílou regulovatelnou kónickou tryskou
0,8 l/min při 2,5 baru s šedou plochou tryskou
- Užitečný obsah: 1 l
- Celkový obsah: 1,35 l



YouTube Clip



HAZET No.	l	kg	EAN-No. 4000896+	€
199 N-1	1	0,46	189007	37,-





199 Tlakový postřikovač · pěnový

• **Tři trysky (součástí dodávky) k vytváření mokrých a suchých pěn a rovněž k realizaci různých dob působení**

- Použití: Vytváření husté a trvanlivé pěny
 - Čištění, dezinfikování povrchů, obrobků, vozidel, sanitárních zařízení
 - **Lepší vizuální kontrola postřikované plochy**
 - Pro neutrální čističe a rovněž pro zředěné kyselá a alkalická čističe
 - Ideální pro
 - čisticí a dezinfekční práce u polstrování a koberců
 - dezinfikování koupelí a sanitárních zařízení
 - kuchyňský a potravinářský průmysl
 - čištění vozidel, pracovních ploch atd.
 - Průhledná odolná nádrž s ukazatelem stavu naplnění
 - Integrovaný bezpečnostní ventil (2,5 baru) umožňuje odtlakování nádoby před otevřením
 - Těsnění Viton
 - Přípustný provozní tlak: max. 3 bar
 - Užitečný obsah: 0,75 l
 - Celkový obsah: 1,5 l
 - Pro použití chemikálií s povrchově aktivními vlastnostmi (tenzidy)
 - Zvýšení doby kontaktu mezi chemikálií a čištěnou plochou zaručuje zvýšenou účinnost chemického produktu
 - Těsnění a materiály odolné vůči většině kyselin a rozpouštědel a rovněž proti v průmyslu, technice motorových vozidel a profesionálním čištění nejčastěji používaným chemikáliím
 - Široký plnicí otvor
 - Ochranný kryt pro komorový ventil
 - Včetně 3 různých trysek (černá = normální, zelená = suchá, oranžová = mokrá) pro nastavení kvality pěny
 - Speciální tryska „Pěna“ typu vějíře
 - Speciální plochá postřikovací tryska pro vějířový paprsek
 - Včetně 10 náhradních filtrů
 - Flexibilní čerpací páčka zabraňuje zlomení
- Oblasti použití:**
- **Čištění textilií, polštářů a koberců** při současném zabránění nadměrnému zvlhčení pro zkrácení doby schnutí a prevenci plísní a bakterií

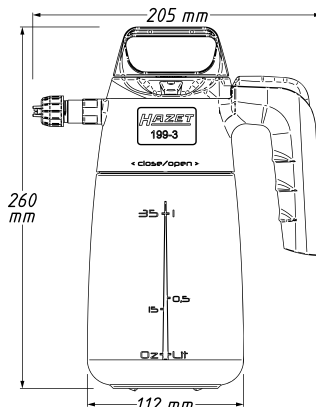

YouTube Clip



HAZET No.		EAN-No. 4000896+	€
199-3	0,75	207237	38,80

Všeobecné dílenské potřeby

1988 Upínací popruh / uvazovací popruh

Made in Germany

- Použití: Bezpečný transport zavazadel a zboží
- Bezpečná přeprava nákladu je nezbytná i pro soukromé osoby a drobné živnostníky
- Délka: 6 m
- Podle EN 12195-2
- Uvazovací síla / páskování: LC (natažení popruhu v %) 1 000 daN v páskování
- Napínací síla / ráčna: STF (napínací síla) 200 daN
- Barva popruhu: světle modrá včetně nátisku loga HAZET, černého



HAZET No.	EAN-No. 4000896+	€
1988-6	219193	12,85

2175 N Paralelní svěrák



HAZET No.	b mm	sf mm	sb max. mm	EAN-No. 4000896+	€
• Paralelní svěrák					
• Kováno v zápustce					
• Šířka upínacích čelistí: 100 mm					
• Montáž na pracovní stůl <i>Assistent</i> 177 W · 179 W · 179 N W ve spojení s upevňovací sadou pro svěrák 179 N W-11 Montáž na dílenský vozík <i>Assistent</i> 177 ve spojení s dřevěnou podložkou 2175 N-11					
2175 N	100	50	125	013685	233,50
• Podložka (ze dřeva) pro paralelní svěrák 2175 N					
• Montáž svěráku na dílenské stoly nebo dílenské vozíky <i>Assistent</i> 172 HD, 177, 180, 180 K-4					
• Včetně montážního příslušenství					
2175 N-11	-	-	-	013692	32,30



Ochrana při práci

1987-5 Rukavice pro mechaniku

- Vysoká odolnost proti oděru díky optimálnímu mixu umělé kůže (dlaně) a PVC, chrániče na vnější straně
- Vynikající elastické vlastnosti, skvěle padnoucí tvar, volnost pohybu a dokonalá hbitost prstů díky zvláštnímu strečovému materiálu Bignet®
- Prodyšné
- Neklouzavé
- Pratelné
- Materiál: 48% polyamid/nylon, 25% polyakryl, 25% polyester, 2% polyuretan



HAZET No.	EAN-No. 4000896+	€
• Velikost L		
1987-5 L	181735	27,05
• Velikost XL		
1987-5 XL	181759	27,05
• Velikost XXL		
1987-5 XXL	181766	27,05

1987 Rukavice pro mechaniku

- Ochrana pomocí protektorů TPR a jemné tkaniny
- Plocha dlaně: maximální odolnost proti oděru díky vysoce kvalitnímu povrstvení nitrilkaučukem
- Vysoká pevnost uchopení
- Velmi dobrá volnost pohybu a příjemné nošení
- Dlouhá doba používání díky kvalitně vybraným komponentám materiálů
- Snadná péče
- Velikost: L
- Přezkoušené vůči zvýšeným mechanickým rizikům dle normy EN 388:2016
Doplňující zkouška proti proříznutí dle normy EN ISO 13997 s výkonovými stupni 4131A



HAZET No.	EAN-No. 4000896+	€
1987-6	222643	11,25

1987 Pracovní rukavice · pravá kůže

- Příjemný, lehký pocit při nošení a vynikající hbitost prstů díky vysoce kvalitní koží kůži
- Vysoce kvalitní směs materiálů z poddajné pravé kůže a moderních textilií z mikrovláken
- Přesně padnou díky pásku Velcro® (se suchým zipem)
- Lehké a prodyšné
- Přezkoušené vůči zvýšeným mechanickým rizikům dle normy EN 388:2016
Zkouška proti proříznutí dle normy EN ISO 13997 s výkonovými stupni 2111A
- Velikost: L



HAZET No.	EAN-No. 4000896+	€
1987 N-3	222650	8,80

1987 Rukavice

- Povrstvení mikropěnou
- Prodyšný chránič
- Maximální flexibilita a volnost pohybu spolu s vynikající mechanickou odolností
- Odpuzuje vodu
- Materiál: 60% bavlna, 40% polyester



HAZET No.	EAN-No. 4000896+	€
1987 N-4	203840	5,65







Speciální nářadí

	Motor	Seřízení motoru / ozubené řemeny Zapalovací a žhavicí svíčka Hlava válců Ventily/písty Palivové systémy / vstřikování Chladicí systém / hadicové spojení Diagnostika Výfukový systém / lambda sonda	381–384 385–389 390 391–392 392–399 400–403 404–407 408–409	
	Převodovka	Spojka	409	
	Olejový servis		410–415	
	Servis brzd		415–423	
	Podvozek	Stahovák pružin / tlumič Ložisko kola / náboj kola Silentblok Kloubové hřídele Kola / pneumatiky	424–434 434–444 445–446 446–449 450–451	
	Elektrický systém / servis baterií	Elektrická zkouška Servis baterií Kontakty / konektory / vypichovák kabelů Alternátor / rádia	452 452–453 453–455 456–457	
	Karoserie / vnitřní vybavení	Oprava karoserie Autoskla / rameno stěrače Volant	458–465 466 467	
	Užitková motorová vozidla (UV)	Motor Olejový servis Servis brzd Podvozek Elektrický systém / servis baterií Karoserie / vnitřní vybavení	467–470 470–471 471–473 473–480 480–481 481	



Univerzální stahovák pružin 4903

... a všechno sedí. Bezpečně!

- Krátká doba přizpůsobení díky jednoduché manipulaci
- Komfortní, bezpečná obsluha jednou osobou
- Jasný tok práce („žádná babračka“)
- Top manipulace díky 90° sklápění
- Umožněna strojní manipulace bez rázů (např. akumulátorový šroubovák nebo pneumatický ráčnový šroubovák)
- Vhodné prakticky pro každý tvar pružiny nebo provedení pružiny
- Samotné přídavné nebo přivařené díly zpravidla nezpůsobují omezení
- Vhodné pro téměř každý tvar čelní desky (mimo jiné možnost upnutí s otočením o 180°)
- Vhodné pro všechny případy použití v dílně díky možnosti mobilního a stacionárního využití zařízení
- Pevné uložení pružiny a zejména montáž bez zatížení dodávají pocit bezpečí
- V 90 % všech případů lze oproti běžným konkurenčním výrobkům dosáhnout časové úspory cca 20 minut na vozidlo u defektních tlumičů
- Úspora času při kompletní demontáži pružicí jednotky (McPherson) cca 10 minut

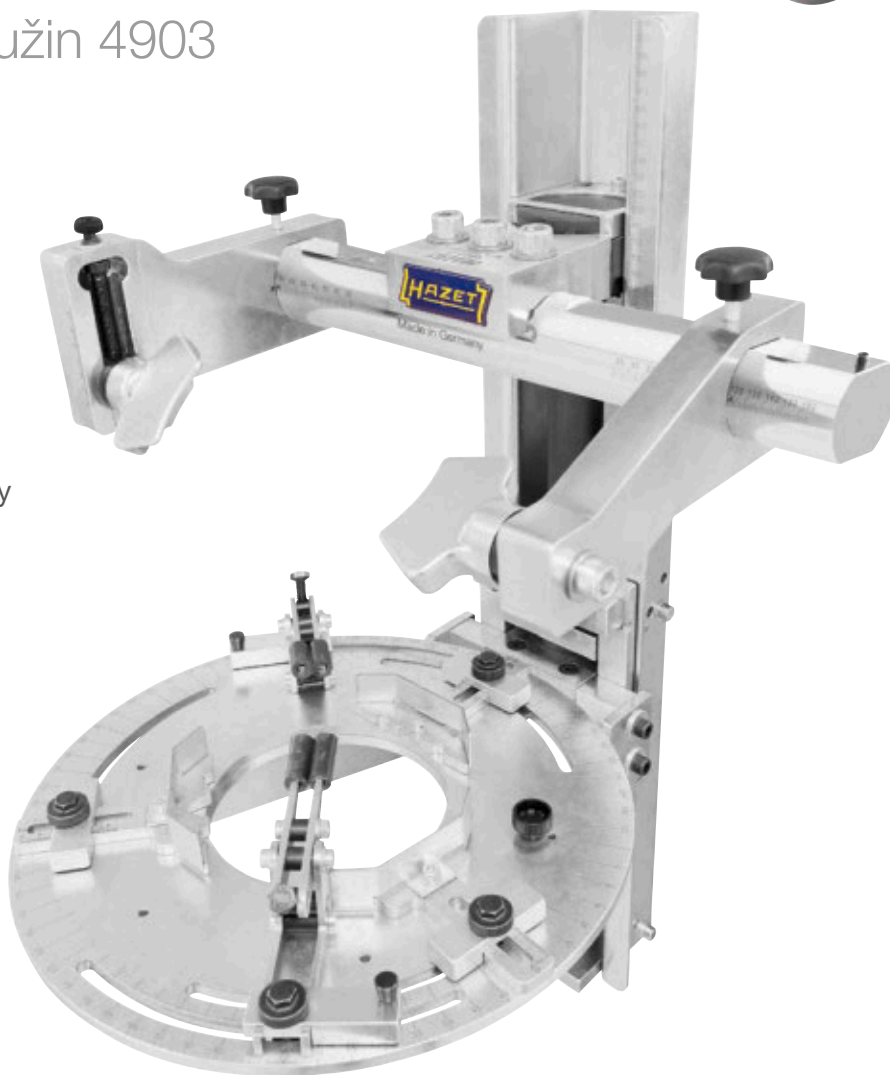

5 kroků k úspěchu

Zajištění pružicí jednotky



Výklopný



Optimální pracovní výška cca 1,30 m

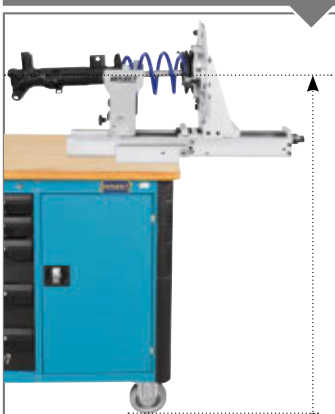

Ovládání



Bez zátěže! Demontovat



www.hazet.de

Další informace:

HAZET Youtube kanál

Video s návodem 4903

HAZET Youtube kanál

Video s návodem 4903/4 W 203



Úspora času při použití univerzálních stahováků pružin HAZET oproti běžným aplikacím

Potřebné pracovní kroky výměny tlumičů	HAZET 4903/4	Úspora času oproti konkurenci
Upnutí	Nekomplikovaná obsluha	
Ovládání	Srovnatelné nebo v porovnání s aku šroubovákem výrazně rychlejší	
Uvolnění	Není nutné	
Vynětí	Srovnatelné	
Ovládání	Není nutné	
Uvolnění	Srovnatelné	
Vyjmutí nohy	Srovnatelné	
Upnutí druhého tlumiče pérování	Značná úspora: snazší / jednodušší / méně komplikované	
Ovládání	Srovnatelné nebo v porovnání s aku šroubovákem výrazně rychlejší	
Uvolnění	Není nutné	
Vynětí	Srovnatelné	
Ovládání	Není nutné	
Uvolnění	Srovnatelné	
Vyjmutí nohy	Srovnatelné	

- Univerzální použití pro téměř všechny pružicí/tlumicí jednotky
- Nový způsob uchycení a koncept montáže
- Vysoká bezpečnost
- Možnost dokumentace díky měřítku
- Bezpečnost investice díky použití stávajících komponentů SYSTEM 4900 [1]

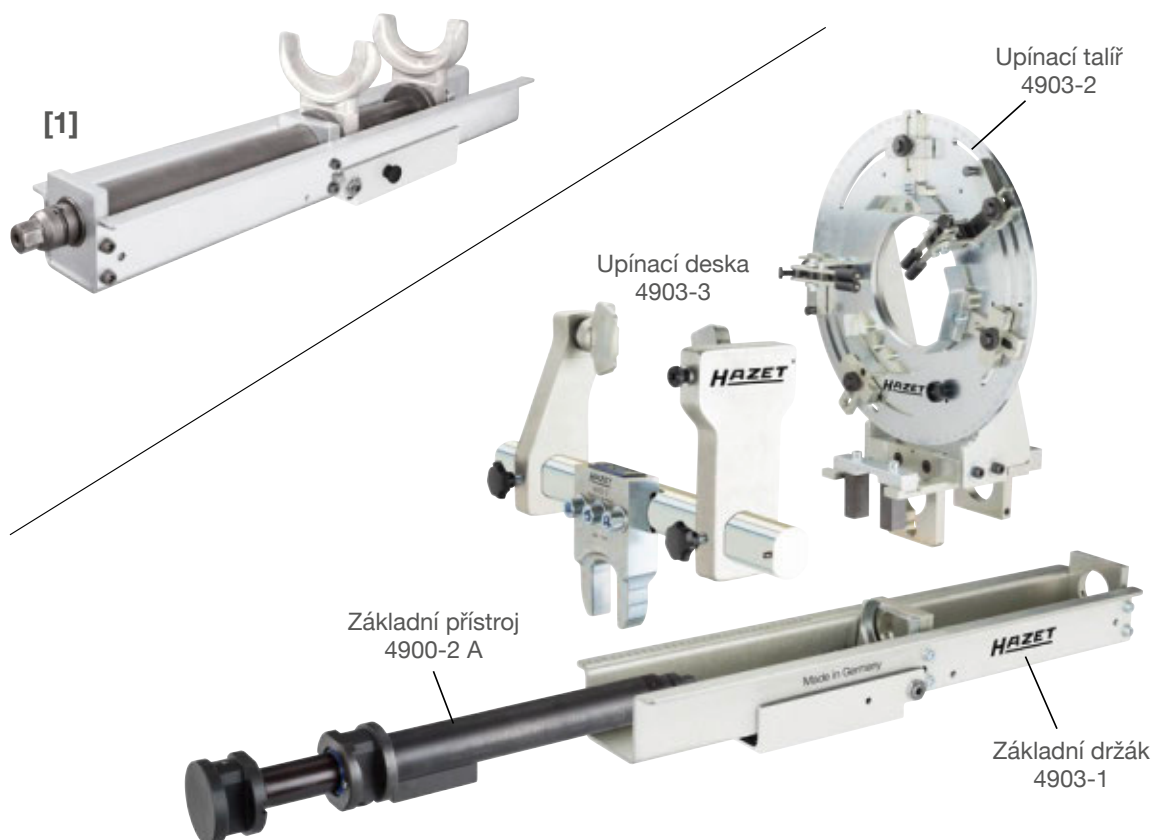

Patentováno

Made in Germany





Sady nářadí HAZET na kompaktní ložiskovou jednotku náboje kola

Rozmanitost se systémem!

- Pro demontáž a montáž ložiskových jednotek nábojů kol v zabudovaném stavu na vozidlech skupiny **VOLKSWAGEN (VW, AUDI, SEAT, ŠKODA)**
- Zajišťuje bezpečnost a efektivitu
- Vhodné pro všechny běžné rozměry ložisek náboje kola
- Lze použít se závitovým vřetenem 4930-1 a vřetenovou maticí 4930-2
- Výhodná základní sada pro \varnothing 72 mm ložiska kol
- Perfektní doplňkové sady pro \varnothing 62 mm a \varnothing 66 mm
- Program vhodně doplňuje speciální sada pro \varnothing 85 mm jednotky



Návrh použití:



Tip pro sestavy

od profesionálů pro profesionály:

- | | | | |
|---|--------------|---------------------------|------------------------|
| | 4934-2572/12 | – základní sada | (\varnothing 72 mm) |
| + | 4934-2562/6 | – doplňková sada | (\varnothing 62 mm) |
| + | 4934-6605/3 | – montážní opěrné kroužky | (\varnothing 66 mm) |

= perfektní vybavení

**Lze objednat jednotlivé díly –
obratte se na svého
partnera HAZET!**

Made in Germany



Speciální nářadí HAZET –
specialista pro opravdové specialisty



Dobré nápady –
chytře realizované
firmou HAZET



Speciální nářadí

Motor – Seřízení motoru / ozubené řemeny



Motor

Seřízení motoru / ozubené řemeny

220 Univerzální podpěra motoru

Made in Germany

• Pro příčně uložené motory

- Použití: Podepření motoru při práci na silentblocích motoru, ozubeném řemenu, vodní pumpě nebo napínací kladce
- Použitelné téměř u všech vozidel
- Po odstranění držáku motoru zůstává motor za pomoci podpěry motoru během opravářských prací v motorovém prostoru (úspora času a vysoká bezpečnost)
- Montáž podpěry motoru pod vozidlem umožňuje optimální přístup při provádění údržby (motor zesponu zajištěn podpěrou motoru) Optimální práce v motorovém prostoru (shora)
- Žádné překážky od konstrukčních dílů při opravách je hlavní výhodou proti práci s mostem pro přidržení motoru nebo jeřábem (oba jsou umístěny nad motorem a mohou být překážkou při opravách motoru)
- Upozornění ohledně použití hrazdy pro zvedání motorů:
 - U novějších vozidel jsou blatníky často sešikmené nebo jsou vyrobeny z plastu. Proto jsou hrazdy pro zvedání motorů na rozdíl od univerzální podpěry motoru HAZET často nevhodné a nelze je namontovat bez rizika poškození
- Flexibilní nastavení opěrného bodu díky kulovému uložení gumové podpěry
- Variabilní délka: 620 – 900 mm
- Včetně 2 montážních držáků
- Celozinkovaná pro optimální ochranu povrchu
- Manuální ovládání pomocí kolíkových rukojetí, resp. křídlových šroubů
- Maximální nosnost: 250 kg



HAZET No.	EAN-No. 4000896+	€
220-1	191758	730,-



1789 N Stahovák řemenic

Made in Germany

• Použití: Stahování řemenic osobních automobilů, SUV a transportérů

• Varianta pro řemenice se závitovými otvory, manipulace s:

- 1 nosník, krátký pro řemenice 43 až 120 mm Ø
- 1 nosník, dlouhý pro řemenice 95 až 210 mm Ø
- 3 výměnné tlačné díly jako prodloužení vřetene

• Varianta pro řemenice bez závitových otvorů (pro uchycení zezadu), manipulace s:

- 1 nosník, krátký pro řemenice 23 až 100 mm Ø
- 1 nosník, dlouhý pro řemenice 85 až 195 mm Ø
- Stahovací háky pro těsné prostory pro upínací hloubku do 68 mm, resp. prodloužení do 88 mm

• Varianta se 2 ozubenými háky (sáhnou pro stáhnutí do drážek řemenice, když není možné uchycení zezadu), manipulace s:

- 1 nosník, krátký pro řemenice 80 až 140 mm Ø
- 1 nosník, dlouhý pro řemenice 135 až 235 mm Ø



HAZET No.	EAN-No. 4000896+	€
1789 N-1	158621	334,40

2540 Přidržovák ozubené řemenice

Made in Germany

• Použití: Montáž a demontáž ozubených řemenic na vačkovém hřídeli, klikovém hřídeli a vstříkovacím čerpadle

• Držák s výměnnými čepi

• U VW Lupo · Polo · New Beetle · Golf · Caddy · Bora · Touran · Sharan · Transporter

AUDI A2 · A3 · A4 · A6 · TT

ŠKODA Fabia · Octavia · Superb

• Rozteč čepů: 100 mm a 46 mm

Šířka otvoru 33 mm

• Rukojeť s povrchem naneseným namáčením

• Povrch: chromováno



HAZET No.	l mm	EAN-No. 4000896+	€
2540-1	722	110407	122,90



2587 Klíč pro dvouděrové matice ozubených řemenů

Made in Germany

• Pro profesionální opravy motoru

- Použití: Nastavení ozubeného řemenu u napínací kladky
- AUDI A3 1,9 TDi · A4 1,6 · 1,6 I diesel
- SEAT Toledo 1,6 · 1,8 · 2,0 · 1,8 16V · 2,0 16V
- VW Golf 1,9 SDi · TDi · Golf · Jetta · Passat 1,6 I diesel · Passat 1,6 · Passat 2,0 · Polo 1,9 SDi · TDi
- ŠKODA 1,6–1,9 I diesel
- Zakřivený
- Rozstup mezi čepy 18 mm, Ø čepu 2,9 mm

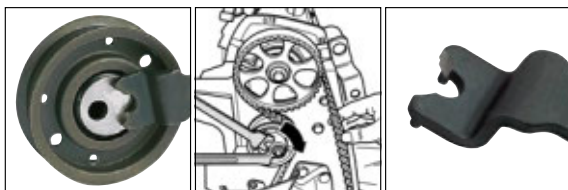

HAZET No.	l mm	EAN-No. 4000896+	€
2587	140	017140	16,05

Made in Germany

• Pro profesionální opravy motoru

- Použití: Nastavení ozubeného řemene na napínací kladce
- AUDI A2 1,2 TDi · A3 1,9 TDi · A4 1,9 TDi · A4 2,0 a 2,0 FSi · A4 4-válc. · A6 2,0
- SEAT Alhambra 1,9 TDi · Ibiza 1,9 TDi · León 1,9 TDi
- VW Golf 1,9 TDi · Golf Plus 2,0 I (4-válc.) · Lupo 3-válc. diesel · Passat 2,0 16V · Passat TDi · Polo 1,4 TDi · Polo 1,9 TDi · Polo 3-válc. diesel · 4-válc. čerpadlo – tryska · Sharan 1,9 TDi
- ŠKODA Octavia 1,9 TDi
- Rozstup mezi čepy 18 mm, Ø čepu 3 mm
- Povrch: matně chromováno



HAZET No.	l mm	EAN-No. 4000896+	€
2587-1	250	053476	30,45

Made in Germany

• Pro profesionální opravy motoru

- Použití: Nastavení ozubeného řemene na napínací kladce
- VW Golf 3 · 4 · 5 · 6 1,9 TDi · 2,0 TDi · benzínový
- Beetle 2,0 I benzínový
- Transporter T5 4-válc. diesel
- AUDI A3, ŠKODA Octavia
- Rozstup mezi čepy 18 mm, Ø čepu 3 mm
- Zahnutí v úhlu 15°
- Povrch: matně chromováno



HAZET No.	l mm	EAN-No. 4000896+	€
2587-2	258	072439	30,45

3087 Poháněcí nářadí pro napínací kladky

Made in Germany

• Odpadnutí ovládnutí napínacích kladek nevhodnými pomůckami jako např. šroubováky, které při smeknutí vedou k poškození řemenu

- Použití: Zjednodušené napnutí ozubeného řemenu přes napínací kladku
- ALFA ROMEO: 145, 146, 147, 156, 159, 166 · Brera · Giulietta · GT · Mito · Spider
- motory: 1,6 JTDM · 1,9 JTD · 1,9 JTDM · 2,0 JTD · 2,4 JTD
- FIAT: 500L · 500X · Brava · Bravo · Croma · Doblò · Ducato · Freemont · Grande Punto · Idea · Marea · Multipla · Punto · Sedici · Stilo
- motory: 1,6D · 2,0 D · 1,9 TD · 1,9 JTD · 2,0 JTD · 2,4 TD · 2,4 JTD
- LANCIA: Delta · Kappa · Kappa SW · Lybra · Lybra SW · Musa · Thesis
- motory 1,6 D · 1,9 D · 2,0 D · 1,9 JTD · 2,4 JTD
- OPEL: Astra H · Astra J · Cascada · Combo · Insignia · Signum · Vectra C · Zafira B
- motory: 1,9 CDTI · 2,0 CDTI
- SAAB: 9-3 · 9-5
- motory: 1,9 TiD/TTiD · 2,0 TiD · 2,2 TTiD
- SUZUKI: SX4 motor 1,9 DDiS
- Ergonomická 2komponentní rukojeť HAZET
- Povrch: zinkováno

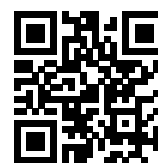

YouTube Clip

HAZET No.	EAN-No. 4000896+	€
3087-1	206759	38,50



Použití výrobku

Nářadí pro nastavení motoru

hazet.de → Servis → Poradce pro použití
→ Nářadí pro nastavení motoru

◀ Pro smartphony s aplikací QR Reader

2588 Nářadí pro seřizování motorů AUDI · VW · SEAT · ŠKODA

• Pro profesionální opravy motoru



- Použití: Pro výměnu ozubeného řemene a další opravy na motoru
- Snadno srozumitelný návod včetně přečíslování na čísla originálního nářadí
- Jednotlivé díly volitelně k dodání
- **Benzínové motory:**
1,4 · 1,6 · 1,8 · 1,8 T · 2,0 16V
AUDI 80 · A2 · A3 · S3 · A4 · A6 · TT
SEAT Arosa · Ibiza · Córdoba · León · Toledo · Inca · Alhambra
ŠKODA Felicia · Octavia
- VW Lupo · Polo · Caddy · Golf · Bora · New Beetle · Passat · Sharan · Touran
- **Diesellové motory:**
motory čerpadlo-tryska 1,2 · 1,4 · 1,9 · 2,0 TDi
AUDI 80 · A2 · A3 · A4 · A6 · Cabriolet
SEAT Ibiza · Córdoba · León · Toledo · Inca · Arosa · Alhambra · Altea
ŠKODA Felicia · Octavia · Fabia
VW Lupo · Polo · Caddy · Golf · Bora · New Beetle · Passat · Sharan · Touran · Transporter · 1,7 · 1,9 D / TD / SDi / TDi
- SmartCase (1/3) 165-L
- Safety-Insert-System, 2komponentní vložka z měkké pěny. Vložka vhodná také pro HAZET-Assistent



1/3			

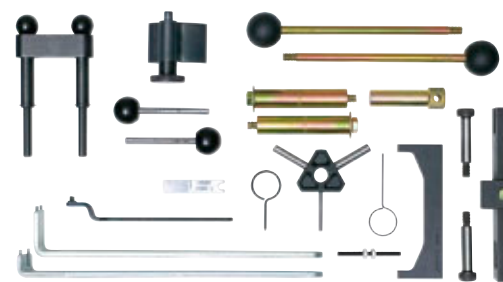



Speciální nářadí

Motor – Seřízení motoru / ozubené řemeny



2588 Nářadí pro seřizování motorů AUDI · VW · SEAT · ŠKODA

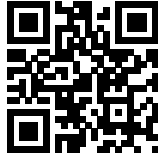
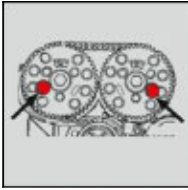

YouTube Clip



HAZET No.	dxšxv mm		EAN-No. 4000896+	€
2588/19	355x235x65	19	127771	388,90
• Aretace vačkových hřídelí				
2588-4	-	-	110391	55,15
2587	-	-	017140	16,05
2587-1	-	-	053476	30,45
2587-2	-	-	072439	30,45
• Zarážka klikové hřídele				
• Zajištění klikové hřídele				
• Pro např. VW 1,6 I a 2,0 I Common-Rail dieselový motor				
2588-1	-	-	087730	88,85
• Blokovací destička				
• Zajištění napínací kladky				
2588-2	-	-	087747	10,90
• Vymezovací kolík				
• Zajištění kol vačkové hřídele				
• Pro např. VW 1,6 I a 2,0 I Common-Rail dieselový motor				
2588-3	-	-	087754	18,25
• Nastavovací nářadí				
2588-9	-	-	137565	63,10

Pro profesionální opravy motoru



- Doplněk pro sadu 2588/19
- **Benzinové motory:** 1,2 6V a 12V 3válcový motor, VW Polo a Fox · ŠKODA Fabia · SEAT Ibiza · Córdoba
- **1,4–1,6 FSI motory:** AUDI A3 · ŠKODA Octavia · VW Polo · Golf · Touran · Tiguan · EOS · Passat
- **Dieselové motory:** VW a koncernová vozidla 4válcové dieselové motory čerpadlo-tryska r.v. 2005 →
- Vložka z měkké pěny

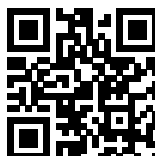

YouTube Clip

HAZET No.		EAN-No. 4000896+	€
2588/9	9	144181	350,80
• Fixační čep			
2588-15	-	144204	41,05
• Zarážka klikové hřídele			
• Pro 4válcové dieselové motory čerpadlo-tryska r.v. 2005 a VW 2,0 I Common-Rail dieselový motor			
• Zarážka klikové hřídele			
• Aretace oválných rozvodových kol klikové hřídele, např. při výměně ozubeného řemene nebo jiných opravách motoru			
2588-110	-	143283	65,-
• Nářadí pro měření horní úvratě – použití ve spojení s malým číselníkovým úchylkoměrem 2155-65			
3688-10	-	137527	110,60

2588 Sada nářadí pro výměnu ozubených řemenů

Made in Germany



• Použitím této sady nářadí se postaráte o to, že při výměně ozubeného řemene nebo opravách motoru budou všechny aretované díly zajištěny ve správné poloze

- Použití: Pro výměnu ozubených řemenů, např. u motorů VW čerpadlo-tryska
- AUDI A2 · A4 · A3 · A6 · VW Passat · Golf · Bora · Beetle · Sharan · Lupo · Touran · SEAT Alhambra · Arosa · Altea · Toledo · León · ŠKODA Octavia · Fabia · Superb · Roomster · FORD Galaxy

Obsah:
zarážka klik. hřídele 2588-1
zajišťovací deska 2588-2
vymezovací kolík 2588-3

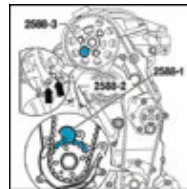

2588-1



2588-2



2588-3

HAZET No.		EAN-No. 4000896+	€
2588/3	3	087761	110,90
• Zarážka klikové hřídele			
• Zajištění klikové hřídele			
• Pro např. VW 1,6 I a 2,0 I Common-Rail dieselový motor			
2588-1	-	087730	88,85
• Blokovací destička			
• Zajištění napínací kladky			
2588-2	-	087747	10,90
• Vymezovací kolík			
• Zajištění kol vačkové hřídele			
• Pro např. VW 1,6 I a 2,0 I Common-Rail dieselový motor			
2588-3	-	087754	18,25

2588 Aretace vačkových hřídelí

Made in Germany



• Použití: Zajištění kola vačkové hřídele při výměně rozvodového řemene

- Oprava motoru u motorů 1,4–1,6 16V
AUDI A2
SEAT Arosa · Ibiza · León · Toledo · Córdoba 1,6 16V · León 1,4 16V
ŠKODA Fabia a Octavia 1,4 16V
VW Bora 1,4 a 1,6 · Caddy 1,4 16V · Caddy · Golf 1,4 a 1,6 · Golf · Bora 1,4 16V · Golf · Bora 1,6 16V · Lupo · Lupo · Polo 1,4 16V · Lupo · Polo 1,6 16V · New Beetle 1,4 · Polo · Polo Classic · Variant

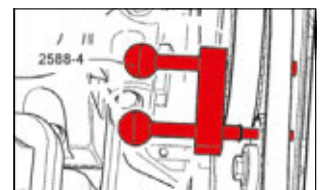

HAZET No.	EAN-No. 4000896+	€
2588-4	110391	55,15



2588 Nářadí pro seřizování motorů AUDI · VW · SEAT · ŠKODA

- Použití: Kontrola a nastavení časování motoru
- Snadno srozumitelný návod včetně přečíslování na čísla originálního nářadí
- Jednotlivé díly volitelně k dodání
- VW 1,2 TFSi benzínové motory
- AUDI A1 · A3
- SEAT Altea/XL · Ibiza · León
- ŠKODA Fabia 2 · Octavia 2 · Roomster · Yeti
- VW Caddy · Golf · Golf Plus · Jetta · Polo · Touran
- Motorcode: CBZA · CBZB · CBZC
- Safety-Insert-System, 2komponentní vložka z měkké pěny. Vložka vhodná také pro HAZET-Assistent



1/9				
-----	--	--	--	--

HAZET No.	d x š mm		EAN-No. 4000896+	€
• Sada nářadí pro nastavení motoru, obsah: 2588-20 (1x) · 21 (1x) · 22 (2x)				
2588-1/4	172x114	4	180325	86,10

2788 Přestavovač vačkových hřídelů TORX® nástrčná hlavice s otvorem

Made in Germany

- Práce na vačkovém hřídeli, rozvodovém řetězu nebo přestavovači vačkových hřídelů



- Použití: Šroubení na přestavovači vačkových hřídelů
- MERCEDES-BENZ: třída C typ 203 · 204 · 205 · CLK 209 třída E typ 211 · 212 · třída E Coupé typ 207 SLK typ 171 · 172 třída G typ 463 · Sprinter typ 906
- Benzínové motory: M133 · 157 · 176 · 177 · 270 · 271 · 271.8 · 271.9 · 272 · 273 · 274 · 276 · 278
- S rýhováním
- Povrch:
- DIN 3124, ISO 2725-1



HAZET No.	l ₁ mm	l ₂ mm	mm	EAN-No. 4000896+	€
2788-T 100 H	60	100	22,15	206650	29,15



3488 Nářadí pro seřizování motorů FORD

- Použití: Pro výměnu ozubeného řemene a další opravy na motoru
- Snadno srozumitelný návod včetně přečíslování na čísla originálního nářadí
- **Benzínové motory:** motory se 2 nahofe uloženými vačkovými hřídeli (Zetec / Duratec) 1,25 · 1,4 · 1,6 · 1,7 · 1,8 · 2,0 16V FORD Fiesta · Escort · Focus · Focus C-Max · Puma · Fusion · Mondeo · Cougar r.v. 1998 → 2001
- **Dieselové motory:** 1,8 D / TD / TDCi / TDdi; 2,0 / 2,4 TDdi · 1,4 / 1,6 TDCi FORD Fiesta · Escort · Orion · Courier · Focus · Focus C-Max · Mondeo r.v. 1988 → 2003 · Fusion · Transit
- SmartCase (1/3) 165-L
- Safety-Insert-System, 2komponentní vložka z měkké pěny. Vložka vhodná také pro HAZET-Assistent



1/3				
-----	--	--	--	--

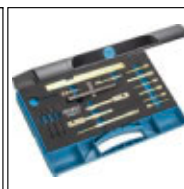
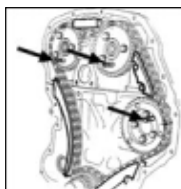
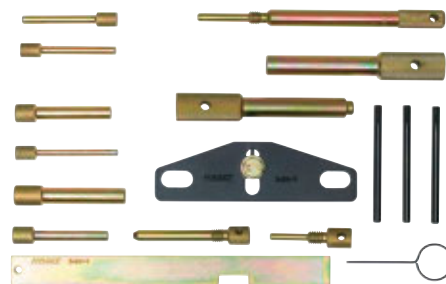

YouTube Clip

HAZET No.	d x š x v mm		EAN-No. 4000896+	€
3488/17	355x235x65	17	127795	230,-
• Blokovací přípravek setrvačnicku				
3488-5	-	-	137060	63,20

- Pro výměnu ozubeného řemene a další opravy na motoru
- **Doplňková sada**
- Pro FORD 1,25–1,4 a 1,6–16V benzín: Fiesta · Fusion · Focus · C-Max 1,6 Ti-VCT benzín: Focus · C-Max 1,4–1,6 TDCi diesel: Fiesta · Fusion · Focus · C-Max 2,0 TDCi diesel: Focus · Mondeo · C-Max · S-Max · Galaxy
- Aretuje vačkovou hřídel/vačkové hřídele při výměně ozubeného řemene
- Nastavení časování / nastavení motoru / napínák rozvodového řetězu
- Vložka z měkké pěny



YouTube Clip

HAZET No.		EAN-No. 4000896+	€
3488/8	8	155873	191,70
• Fixační trn klikové hřídele			
3488-15	-	155910	41,55



Speciální nářadí

Motor – Zapalovací a žhavicí svíčka



Zapalovací a žhavicí svíčka

1849 Kleště na kabelové koncovky zapalovacích svíček

Made in Germany

- Speciálně pro tepelně izolované konektory

- Použití: Stahování a nasazování konektorů zapalovacích svíček
- Přídavný břit
- Ergonomické 2komponentní plastové kryty rukojetí HAZET (modrá/černá)
- Povrch: chromováno



HAZET No.	l / mm	EAN-No. 4000896+	€
1849	195	007080	40,50

Made in Germany

- Bezpečná manipulace díky vyfrézovanému vnitřnímu profilu úchopných pouzder

- Použití: Stahování a nasazování rovných konektorů zapalovacích svíček
- Vhodné zejména pro MERCEDES-BENZ
- Ergonomické 2komponentní plastové kryty rukojetí HAZET (modrá/černá)
- Povrch: chromováno



HAZET No.	l / mm	EAN-No. 4000896+	€
1849-1	200	128037	41,35

Made in Germany

- Dlouhé provedení pro větší bezpečnou vzdálenost od horkého agregátu

- Použití: Stahování a nasazování rovných konektorů zapalovacích svíček
- Zejména pro nízko uložené konektory zapalovacích svíček např. na motorech AUDI V6 resp. V8 JAGUAR 12-válc.
- Ergonomické 2komponentní plastové kryty rukojetí HAZET (modrá/černá)
- Povrch: chromováno



HAZET No.	l / mm	EAN-No. 4000896+	€
1849-2	290	007103	47,65

Made in Germany

- Speciálně pro tepelně izolované konektory

- Použití: Stahování a nasazování konektorů zapalovacích svíček
- Dlouhé provedení
- Ergonomické 2komponentní plastové kryty rukojetí HAZET (modrá/černá)
- Povrch: chromováno



HAZET No.	l / mm	EAN-No. 4000896+	€
1849-3	265	055098	47,65

1849 Stahovák kabelových koncovek zapalovacích svíček

Made in Germany

- Trubkový díl je prořiznutý, tím je zabezpečeno optimální vedení kabelu bez poškození

- Použití: Stahování a nasazování kabelových koncovek zapalovacích svíček, u motorů, zahřátých na provozní teplotu
Pro motor 2,8-2,9 l VR6 VW Golf, Passat, Vento, Corrado, T5 2,0 l, Lupo 4-válc. motor r. v. 1999 →, AUDI A4, A6 s motory 2,6 a 2,8 l V6



HAZET No.	l / mm	EAN-No. 4000896+	€
1849-6	253	007110	38,85

Made in Germany

- Použití i na motoru s provozní teplotou

- Použití: Stahování a nasazování konektorů zapalovacích svíček
- Pro VW Golf 4 · 5 · 6–1,6 l · Polo 5–1,2 l r. v. 2009 →, Bora r. v. 1999 → a Touran r. v. 2004 → s 1,6 l · 4-válc. vstříkovacím motorem s vahadlem s kladkou, New Beetle r. v. 1999 → s 2,0 l · 4-válc. vstříkovacím motorem a 2-ventil. 4-válc. vstříkovacím motorem s vahadlem s kladkou AUDI A3 r. v. 2004 → s 2-ventil. 4-válc. vstříkovacím motorem SEAT · ŠKODA · SMART For Two (typ 450)
- T-rukojeť z plastu



HAZET No.	l / mm	EAN-No. 4000896+	€
1849-9	275	110476	48,95

2131 Kartáč na zapalovací svíčky

Made in Germany

- Vlnité speciální mosazné drátěné štětiny

- Použití: Čištění elektrod a kontaktů zapalovacích svíček
- 3řadý
- Výška drátu 15 mm
- Dřevěné tělo



HAZET No.	l / mm	EAN-No. 4000896+	€
2131	150	012541	3,60

1849 Stahovák cívek zapalování

Made in Germany

- Použití: Demontáž a montáž cívek zapalování s výkonovým koncovým stupněm

- U VW Polo · Fox 1,2 l · Golf 1,4 · 1,6 l · Golf Plus 1,4 l r. v. 2005 → · Caddy 1,4 l · Bora 1,4 · 1,6 l · Beetle 1,4 l (benzín r. v. 2003 →) · Scirocco 1,4 l r. v. 2009 → · Lupo 4-válc. s přímým vstříkáváním r. v. 1999 → · Passat B7 1,4 l TSI · Touran 1,6 l · Phaeton · Transporter T4 · ŠKODA Fabia
- T-rukojeť z plastu
- Povrch: chromováno

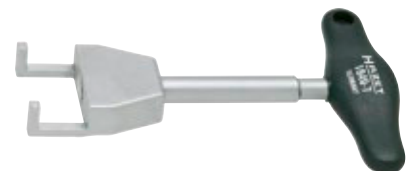

HAZET No.	l / mm	EAN-No. 4000896+	€
1849-7	135	110353	41,95



1849 Stahovák cívek zapalování

Made in Germany

- Použití: **Demontáž a montáž cívek zapalování s výkonovým koncovým stupněm**
- U VW Golf · Bora · Eos 3,2 l r. v. 2006 → · Passat · Sharan · Touareg 6-válc. r. v. 2003 → · Transporter T5 3,2 l 6-válc. vstříkovací r. v. 2004 →
- AUDI TT 3,2 l r. v. 1999 → 2007 · A3 3,2 l r. v. 2004 → · Passat B7 3,6 l FSI
- T-rukojeť z plastu
- Povrch: chromováno



HAZET No.	l mm	EAN-No. 4000896+	€
1849-8	133	110360	37,50

Made in Germany

- Použití: **Demontáž / montáž cívek zapalování s výkonovým koncovým stupněm**
- VW s přímým vstříkáváním 2,0: Golf r. v. 2004 → · Touran r. v. 2004 → · Passat r. v. 2006 → · Eos r. v. 2006 → · Polo r. v. 2002 → 4-válc. 5V · Scirocco r. v. 2009 → 1,8 a 2,0 l · Tiguan r. v. 2006 → 1,8 a 2,0 l · Phaeton r. v. 2003 → 8-válc. Passat B7 1,8–2,0 l TSI
- AUDI s přímým vstříkáváním: A3 r. v. 2004 → 2,0 · A4 r. v. 2002 → 2,0 · A5 r. v. 2008 → 3,2 a 4,2 l · A6 r. v. 2005 → 3,2 · A8 r. v. 2003 → 3,2–4,2 a 5,2 l, TT r. v. 2007 → 1,8 a 2,0 l · R8 r. v. 2008 → 4,2 l · Q5 r. v. 2008 → 2,0 a 3,2 l · Q7 r. v. 2007 → 3,6 a 4,2 l
- T-rukojeť z plastu
- Povrch: chromováno

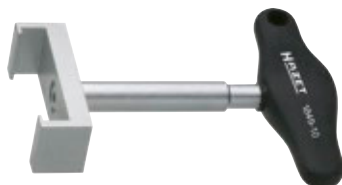

HAZET No.	l mm	EAN-No. 4000896+	€
1849-10	102	132201	36,35

1849 Stahovák kolíkové zapalovací cívky

Made in Germany

- **Rychlé a bezpečné stažení kolíkových zapalovacích cívek**
- Použití: **Demontáž kolíkových zapalovacích cívek na motorech 1,0 l / 1,0 l TSI / TFSI · 1,2 l TSI · 1,4 l TSI / TFSI · 2,0 l GTI**
- Typy vozidel: VW Up r. v. → 2011 · Polo r. v. → 2012 · Golf r. v. → 2013 · Beetle r. v. → 2014 · Caddy r. v. → 2015 · Passat r. v. → 2014 · Tiguan r. v. → 2015 · Touran r. v. → 2015 · Sharan r. v. → 2015
- AUDI A1 r. v. → 2012 · A3 r. v. → 2013
- SEAT Mii r. v. → 2011 · Ibiza r. v. → 2013 · León r. v. → 2013
- ŠKODA Citigo r. v. → 2011 · Fabia r. v. → 2014 · Octavia r. v. → 2013
- T-rukojeť z plastu



YouTube Clip



HAZET No.	l mm	EAN-No. 4000896+	€
1849-12	156	204342	61,65

Přehled klíčů na zapalovací a žhavicí svíčky

HAZET No.	mm	"	l mm	□
4760-2 (G)	8	–	142	10 3/8
2530 (G)	10	–	140	10 3/8
4766-2	14	–	64	10 3/8
4766-3	14	–	154	10 3/8
880 A MgT	16	5/8	64	10 3/8
880 A MgT-1	16	5/8	64	10 3/8
880 A KF	16	5/8	64	10 3/8
900 A MgT	16	5/8	71	12 1/2
900 A KF	16	5/8	71	12 1/2
4766	16	5/8	97	10 3/8
4766-1	16	5/8	270	10 3/8
4767 A KF	16	5/8	480	12 1/2
880 MgT-18	18	–	62	10 3/8
880 MgT	20,8	13/16	64	10 3/8
880 KF	20,8	13/16	64	10 3/8
900 Lg-20,8	20,8	13/16	85	12 1/2
900 TZ-20,8	20,8	13/16	85	12 1/2
900 MgT	20,8	13/16	68	12 1/2
900 KF	20,8	13/16	71	12 1/2
2505-2	20,8	13/16	137,5–197,5	10 3/8

(G) = žhavicí svíčka

880 MGT Nástrčná hlavice na zapalovací svíčky

Made in Germany

- Použití: **Výměna zapalovacích svíček**
- S permanentním magnetem
- Dlouhé provedení
- **Americké rozměry**
- Povrch: chromováno, leštěno
- DIN 3124, ISO 2725-1

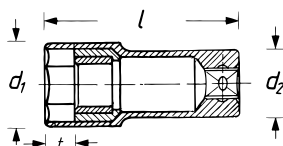

HAZET No.	s mm	s"	l mm	d1 mm	d2 mm	t mm	EAN-No. 4000896+	€
880 Mg T	20,8	13/16	64	27,4	22,5	9	040872	20,15
880 A Mg T	16	5/8	64	21,6	21,6	9	040247	20,15

Made in Germany

- **S permanentním magnetem**
- Použití: **Pro výměnu zapalovacích svíček**
- Vnější šestihran 17 mm
- Např. pro motocykly HONDA · YAMAHA · SUZUKI · KAWASAKI atd.
- Dlouhé provedení
- Povrch: chromováno, leštěno
- DIN 3124, ISO 2725-1

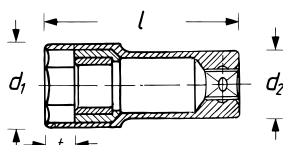

HAZET No.	s mm	l mm	d1 mm	d2 mm	t mm	EAN-No. 4000896+	€
880 Mg T-18	18	62	23,5	22,8	9,6	040889	20,15



Speciální nářadí

Motor – Zapalovací a žhavicí svíčka



880 AMGT Nástrčná hlavice na zapalovací svíčky

Made in Germany

- Vnější vodič kružek 23,6 mm pro hluboko uložené zapalovací svíčky

- Použití: Pro výměnu zapalovacích svíček
- S permanentním magnetem
- Dlouhé provedení
- Americké rozměry
- Povrch: chromováno, leštěno
- DIN 3124, ISO 2725-1

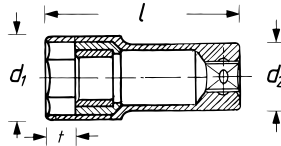

HAZET No.	S mm	S" mm	l mm	d1 mm	d2 mm	t mm	EAN-No. 4000896+	€
880 A Mg T-1	16	5/8	64	21,9	21	9	040254	20,15

880 KF Nástrčná hlavice na zapalovací svíčky

Made in Germany

- Korunová pružina zmenšuje riziko poškození izolátoru

- Použití: Demontáž a montáž zapalovacích svíček (s 20,8mm = 13/16")
- Korunová pružina jako přídržný mechanismus
- Dlouhé provedení
- Americké rozměry
- Povrch: chromováno, leštěno
- DIN 3124, ISO 2725-1

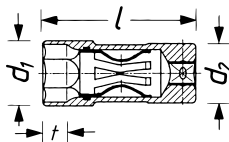

HAZET No.	S mm	S" mm	l mm	d1 mm	d2 mm	t mm	EAN-No. 4000896+	€
880 KF	20,8	13/16	64	27,4	25	10	040674	15,90
880 A KF	16	5/8	64	21,6	21,6	10	040131	15,90

900 MGT Nástrčná hlavice na zapalovací svíčky

Made in Germany

- Pro výměnu zapalovacích svíček
- Permanentní magnet
- Americké rozměry
- Povrch: chromováno, leštěno
- DIN 3124, ISO 2725-1

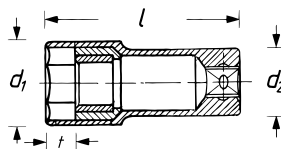

HAZET No.	S mm	S" mm	l mm	d1 mm	d2 mm	t mm	EAN-No. 4000896+	€
900 Mg T	20,8	13/16	68	27,4	23,5	9	044023	20,15
900 A Mg T	16	5/8	71	22,5	22,5	8,5	043491	20,15

Informace – korunková pružina

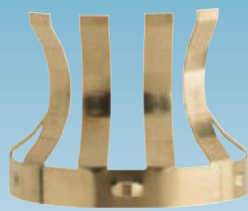
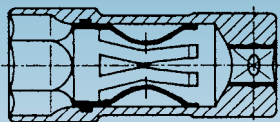

- Korozivzdorná a odolná proti teplu
- Maximální volnost keramického izolátoru
- 6 pružících prvků – bezpečná opora zapalovacích svíček
- Tlumení příčných pohybů

900 KF Nástrčná hlavice na zapalovací svíčky

Made in Germany

- Pro výměnu zapalovacích svíček
- Korunová pružina jako přídržný mechanismus
- Korunová pružina zmenšuje riziko poškození izolátoru
- Americké rozměry
- Povrch: chromováno, leštěno
- DIN 3124, ISO 2725-1

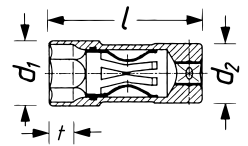

HAZET No.	S mm	S" mm	l mm	d1 mm	d2 mm	t mm	EAN-No. 4000896+	€
900 KF	20,8	13/16	71	27,4	25	10	043859	15,90
900 A KF	16	5/8	71	22,5	22,5	10	043408	15,90

2505 Klíč na zapalovací svíčky

Made in Germany

- Nastavitelná délka od 137,5 na 157,5 a 197,5 mm

- Pro zapalovací svíčky s velikostí klíče 20,8 / 13/16"
- Přídržná guma
- Americké rozměry
- Pohon s kuličkovou drážkou
- Povrch: chromováno
- DIN 3124, ISO 2725-1



HAZET No.	S mm	S" mm	l mm	d1 mm	d2 mm	t mm	EAN-No. 4000896+	€
2505-2	20,8	13/16	197,5	29	16	7	016266	38,80

4766 Klíč na zapalovací svíčky

Made in Germany

- Krátké provedení

- Použití: Demontáž a montáž zapalovacích svíček (C svíček) (s 16 mm = 5/8")
- Např. u motocyklů, BMW C1 · KAWASAKI · YAMAHA · HONDA · SUZUKI · DUCATI · MERCEDES-BENZ osob. voz. např. třída A (typ 168 · 169) · třída B (typ 245) · SMART (typ 451)
- Korunová pružina pro držení zapalovací svíčky
- Americké rozměry
- S kloubem – pro použití na těžko přístupných místech a pro obejití rušivých hran
- Pohon s kuličkovou drážkou
- Povrch: chromováno
- DIN 3124, ISO 2725-1

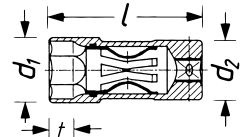
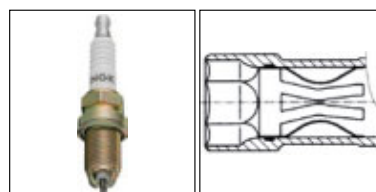

HAZET No.	S mm	S" mm	l mm	d1 mm	d2 mm	t mm	EAN-No. 4000896+	€
4766	16	5/8	97	21,4	18	10	049295	37,05



4766 Klíč na zapalovací svíčky

Made in Germany

• Korunová pružina pro držení zapalovací svíčky

- Použití: Demontáž a montáž zapalovacích svíček (16 mm, resp. 5/8")
- Např. u VW · AUDI · SEAT · ŠKODA · RENAULT · FIAT · FORD · OPEL · BMW · NISSAN · HONDA · MAZDA · MITSUBISHI · KIA · Volvo
- Úhel vychýlení ±50°
- Americké rozměry
- S kloubem – pro použití na těžko přístupných místech a pro obejití rušivých hran
- Pohon s kuličkovou drážkou
- Povrch: chromováno
- DIN 3124, ISO 2725-1

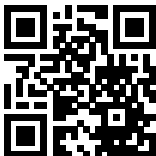

YouTube Clip

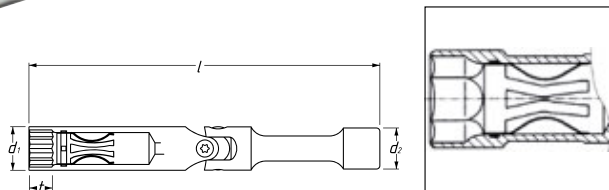

HAZET No.	S mm	S"	l mm	d ₁ mm	d ₂ mm	f mm	EAN-No. 4000896+	€
4766-1	16	5/8	270	21,4	18	10	048991	41,35

Made in Germany

• Profil dvojitého 6hranu umožňuje ovládání zapalovacích svíček 6hranem a dvojitým 6hranem

- Použití: Demontáž a montáž zapalovacích svíček (s 14 mm)
- Korunová pružina pro bezpečné držení zapalovací svíčky
- U BMW E90 N 54 motor 335 i Lim. r. v. 2006 → řada 1 (F20) 118i · RENAULT Modus · Twingo · Clio · Kangoo s motorem 1,2 l 16 V · PEUGEOT 207 · 307 a také CITROËN C4 s motorem 1,4 a 1,6 l 16 V · C5 s motorem 2,0 l HPi · MERCEDES-BENZ motor M 156 · motor M 276 · NISSAN Micra · Note · MINI 1,2 – 1,4 l 4-válc. r. v. 2007 → FORD 1,0 EcoBoost motor · ALFA 1,8 TBI motor · KIA · PORSCHE 911 GT3 r. v. 2014 → 2,9 l · 3 l · 4 l · AUDI 3 l TFSI · VW 3 l TSI
- Pohon s kuličkovou drážkou
- DIN 3124, ISO 2725-1



HAZET No.	S mm	l mm	d ₁ mm	d ₂ mm	f mm	EAN-No. 4000896+	€
4766-2	14	64	18	17,3	10	087655	25,45

Made in Germany

• Profil dvojitého 6hranu umožňuje ovládání 14 mm zapalovacích svíček 6hranem a dvojitým 6hranem

- Použití: Pro 14mm zapalovací svíčky, např. BMW a MERCEDES-BENZ
- Korunová pružina pro bezpečnou stabilitu a bezproblémové nasazení a montáž zapalovací svíčky
- Úhel vychýlení ±56°
- S kloubem – pro použití na těžko přístupných místech a pro obejití rušivých hran
- Pohon s kuličkovou drážkou
- DIN 3124, ISO 2725-1



4766 Klíč na zapalovací svíčky

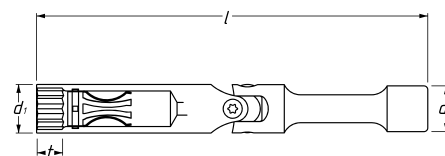

HAZET No.	S mm	l mm	d ₁ mm	d ₂ mm	f mm	EAN-No. 4000896+	€
4766-3	14	154	19,1	18	10	199976	51,90

4767 AKF Klíč na zapalovací svíčky

Made in Germany

• Pružina v kloubu



- Použití: Demontáž a montáž zapalovacích svíček (s 16mm = 5/8")
- Korunová pružina pro držení zapalovací svíčky
- Dlouhé provedení
- Americké rozměry
- Pohon s kuličkovou drážkou
- Povrch: chromováno
- DIN 3124, ISO 2725-1

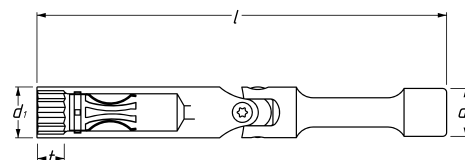
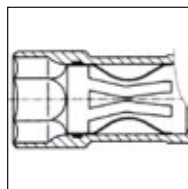

HAZET No.	S mm	S"	l mm	d ₁ mm	d ₂ mm	f mm	EAN-No. 4000896+	€
4767 A KF	16	5/8	480	25,5	23	10	049028	87,50

2530 Nástrčný klíč pro žhavicí svíčky

Made in Germany

• Kuličkové upnutí pro upevnění žhavicí svíčky



- Použití: Demontáž a montáž žhavicích svíček (s 10 mm)
- VW · AUDI diesellový motor s přímým vstřikováním TDI a MERCEDES-BENZ CDI · SMART
- Úhel vychýlení ±45°
- S kloubem – pro použití na těžko přístupných místech a pro obejití rušivých hran
- Pohon s kuličkovou drážkou
- Samoobslužné balení
- Povrch: chromováno
- DIN 3124, ISO 2725-1



HAZET No.	S mm	l mm	d ₁ mm	d ₂ mm	f mm	EAN-No. 4000896+	€
2530	10	140	15	18	9	016341	47,55



Speciální nářadí

Motor – Zapalovací a žhavicí svíčka



4760 Klíč na žhavicí svíčky

Made in Germany

• Kuličkové upnutí pro upevnění žhavicí svíčky



- Použití: Demontáž a montáž žhavicích svíček (s 8 mm)
- Např. u dieselových motorů **MERCEDES-BENZ · SMART · VW · FIAT a OPEL**
- Úhel vychýlení ±45°
- **Americké rozměry**
- S kloubem – pro použití na těžko přístupných místech a pro obejítí rušivých hran
- Pohon s kuličkovou drážkou
- Samoobslužné balení
- Povrch: chromováno
- DIN 3124, ISO 2725-1



HAZET No.	S mm	l mm	d ₁ mm	d ₂ mm	EAN-No. 4000896+	€
4760-2	8	142	11,8	18	118670	41,35

4760 Kleště na kabelovou koncovku žhavicí svíčky

Made in Germany

• Profil kleští speciálně optimalizovaný pro konektory



- Použití: Pro stahování a nasazování konektorů žhavicích svíček na dieselových motorech např. **MERCEDES-BENZ, VW, AUDI, SEAT, ŠKODA a BMW**
- Zahnuté provedení pro použití také u těžko přístupných konektorů žhavicích svíček
- **Výřez zamezuje poškození kabelu**
- Ergonomické 2komponentní plastové kryty rukojetí HAZET (modrá/černá)



HAZET No.	EAN-No. 4000896+	€
4760-5	089130	51,90

4760 Sada vyťahováků žhavicích svíček

Made in Germany

• Vyrážení utržených žhavicích svíček s 8–10 mm

- **Několik hodin úspory času** díky odpadnutí demontáže hlavy válců
- Poškozené závity budou **prořezány** resp. **obnoveny/přepřacovány** (viz také 4760-M8 až -M10)
- SmartCase (1/3) 165-L
- Safety-Insert-System, 2komponentní vložka z měkké pěny. Vložka vhodná také pro HAZET-Assistent

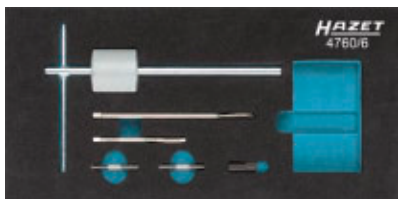

1/3			
-----	--	--	--

4760 Sada vyťahováků žhavicích svíček

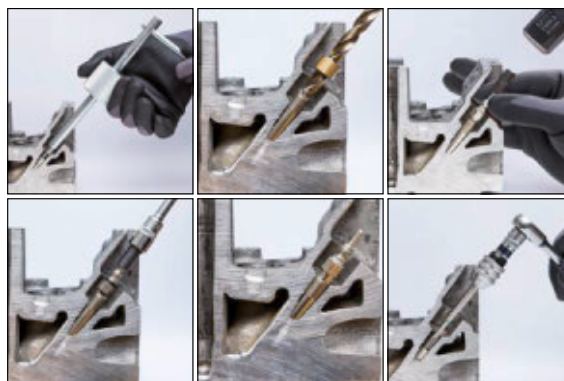

HAZET No.	d x š x v mm	€	EAN-No. 4000896+
4760/6	355x235x65	316,50	191642

4760 Sada pro opravu žhavicích svíček

Made in Germany

• Oprava závitů bez demontáže hlavy válců

- Ve spojení se sadou vyťahováků žhavicích svíček 4760/6
- SmartCase (1/9) 165-S
- Safety-Insert-System, 2komponentní vložka z měkké pěny. Vložka vhodná také pro HAZET-Assistent

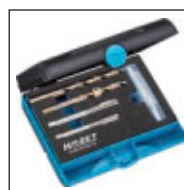
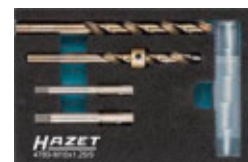

YouTube Clip

HAZET No.	d x š x v mm	€	EAN-No. 4000896+
4760-M 8 x 1/9	185x153x52	286,90	191536
4760-M 10 x 1/9	185x153x52	316,50	191529

- Vytržené závity M8 x 1 budou předělány na závit M10 x 1
- 1 spirálový vrták 6,8 mm s distančním pouzdrem
- 1 závitník M 8 x 1
- 1 závitník M 10 x 1
- 1 spirálový vrták 9 mm
- 5 závitových vložek M 8 x 1

4760-M 8 x 1/9 185x153x52 9 191536 286,90

- Vytržené závity M10 x 1 budou předělány na závit M12 x 1
- 1 spirálový vrták 9 mm s distančním pouzdrem
- 1 závitník M 10 x 1
- 1 závitník M 12 x 1
- 1 spirálový vrták 11 mm
- 5 závitových vložek M 10 x 1

4760-M 10 x 1/9 185x153x52 9 191529 316,50

4760 Demontážní / montážní pomocný nástroj

• Zabráni se pádu a tím poškození žhavicích nebo zapalovacích svíček při demontáži/montáži

- Použití: Pomocný nástroj k bezpečnému přidržení žhavicích nebo zapalovacích svíček zvláště za stísněných prostorových poměrů
- Celogumové provedení
- Délka 230 mm umožňuje pečlivé vyšroubování a zašroubování



HAZET No.	l mm	€	EAN-No. 4000896+
4760-11	230	16,45	222346



Hlava válců

Povrchová úprava TiN

TiN

Proč povrchová úprava TiN (nitrid titanu)?

- Speciální metoda velmi tvrdé povrchové úpravy TiN dosahuje extrémně vysoké přilnavosti a otěruvzdornosti vrstvy
- Optimálně vhodné při dlouhodobém zatížení, např. sériovém šroubování v průmyslu a dílnách
- Vyšší ochrana proti opotřebení zajišťuje delší životnost
- Perfektní přesnost díky optimální tloušťce vrstvy
- Vyšší utahovací moment
- Optimální ochrana proti korozi

Nástrčné hlavice s TiN úpravou

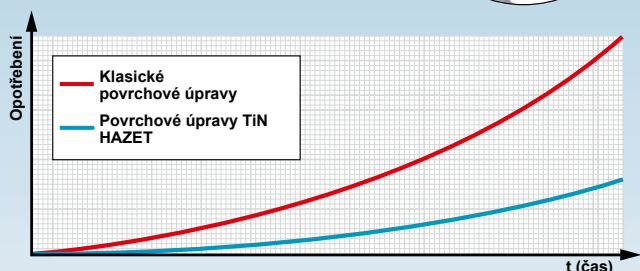
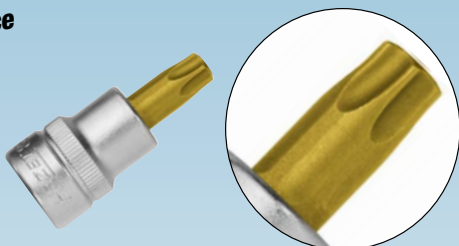

986 SL Nástrčná hlavice

Made in Germany

- Extra dlouhé provedení
- S rýhováním
- Povrch:
- DIN 7422, DIN 3124, ISO 2725-1



HAZET No.	S mm	l ₁ mm	l ₂ mm	d mm	EAN-No. 4000896+	€
986 SL- 8	8	102	140	23	232345	14,35
986 SL-10	10	102	140	23	232321	14,35

990 Nástrčná hlavice

Made in Germany

- Použití: Šroubení hlavy válců (šrouby XZN)
- Krátké provedení
- S rýhováním
- Povrch:
- DIN 3124, ISO 2725-1

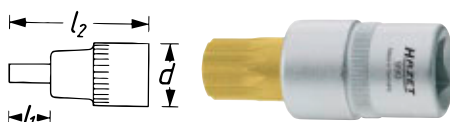

990 Nástrčná hlavice



HAZET No.	l ₁ mm	l ₂ mm	d mm	EAN-No. 4000896+	€
990-10	15	53	23	047253	18,35
990 Lg-9	62	100	23	103140	19,85
990 Lg-14	62	100	23	065240	26,90
990 S Lg-10	82	120	23	047369	26,60
990 S Lg-12	102	140	23	047376	29,-
2751	100	140	23	017508	30,40

991 Nástrčná hlavice

Made in Germany

- Použití: Pro šrouby hlav válců u FIAT 2,0 motorů
- Krátké provedení
- S rýhováním
- Povrch:
- DIN 3124, ISO 2725-1

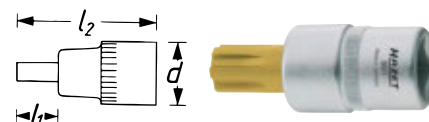

HAZET No.	l ₁ mm	l ₂ mm	d mm	EAN-No. 4000896+	€
991-12	25	63	23	047413	23,05

992 LG Nástrčná hlavice TORX®

Made in Germany

- Použití: Šroubení hlavy válců (pro vnitřní TORX® šrouby T 55)
- Dlouhé provedení
- S rýhováním
- Povrch:
- DIN 3124, ISO 2725-1



HAZET No.	l ₁ mm	l ₂ mm	d mm	mm	EAN-No. 4000896+	€
992 S Lg-T 55	102	138	23	11,22	047642	33,30
992 Lg-T 55	57	96	23,3	11,22	057337	28,50
992 Lg-T 70	67	105	24,6	15,54	047611	41,25

2579 Nástrčná hlavice pro hlavu válce

Made in Germany

- Použití: Manipulace se šrouby hlavy válců Polydrive na VW motorech (VW, AUDI, SEAT, ŠKODA) a motorech FORD 1,0 EcoBoost
- Extra dlouhé provedení
- S rýhováním
- DIN 3124, ISO 2725-1



HAZET No.	l ₁ mm	l ₂ mm	d mm	EAN-No. 4000896+	€
2579-9	130	168	23	086931	22,40



Speciální nářadí

Motor – Ventily/písty



Ventily/písty

794 Upínací pás na pístní kroužky

Made in Germany

- S upínacím klíčem
- Plynulé nastavení
- Vysokopevnostní pružinová pásová ocel
- Pojistná pružina zabrání nechtěnému vyskočení



HAZET No.	h mm	Ø mm	EAN-No. 4000896+	€
794-01	50	40–75	031597	22,50
794-1	80	60–125	031610	37,70
794-2	80	90–175	031641	43,75

794 U Kleština na pístní kroužek

Made in Germany

- Použití: Napínání pístních kroužků u vodou a vzduchem chlazených motorů
- Napínací pás (32 mm široký), odepínací
- Povrch: chromováno

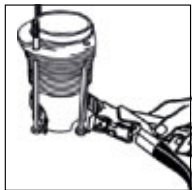

HAZET No.	l mm	h mm	Ø mm	EAN-No. 4000896+	€
794 U-3	332	32	70–100	031672	120,70

790 Kleště na pístní kroužky

Made in Germany

- Použití: Snímání a nasazování pístních kroužků
- Povrch: leštěný zinek



HAZET No.	l mm	Ø mm	EAN-No. 4000896+	€
790-1	220	50–100	031412	36,85
790-1 a	240	65–110	031429	39,40

Made in Germany

- Držák hranolů

- Použití: Bezpečné uchopení různých typů pístních kroužků
- Povrch: niklováno, kleštiny držáku mořeny



790 Kleště na pístní kroužky



HAZET No.	l mm	Ø mm	EAN-No. 4000896+	€
790-3	220	60–120	031450	51,55

795 Zabušovačka sedla ventilu

Made in Germany

- S přísavkou



HAZET No.	Ø mm	EAN-No. 4000896+	€
795-1	20	031771	7,10
795-2	25	031788	7,10
795-3	30	031795	7,15
795-4	37	031801	7,95

792 Přípravky pro stlačování pružin ventilů

Made in Germany

- Použití: Upínání ventilových pružin
- Po 1 páru rovných a zahnutých čelistí, 792-1 s rovnou čelistí · sb 75-225 se zahnutou čelistí · sb 45-195
- Povrch: leštěný zinek



HAZET No.	l mm	EAN-No. 4000896+	€
792-1	290	031481	91,90

791 Kleště na těsnící kroužek ventilového dřívku

Made in Germany

- Tvrdžené čelisti, příčné ozubení

- Použití: Stahování těsnění ventilových dřívků u 2ventilových motorů
- U FORD · OPEL · NISSAN atd.
- Povrch: niklováno, čelisti mořeny



HAZET No.	l mm	EAN-No. 4000896+	€
791-5	250	031467	63,15



791 Kleště na těsnicí kroužek ventilového dřívku

Made in Germany

• Tvrzené čelisti, příčné ozubení, povrstvené ponořením



- Použití: Bezvadné stažení hlubokou uložených těsnění ventilových dřívků (**víceventilové motory**) díky mimořádně dlouhým čelistem
- Např. u **AUDI · FORD · OPEL**
- Rovná
- Povrch: niklováno

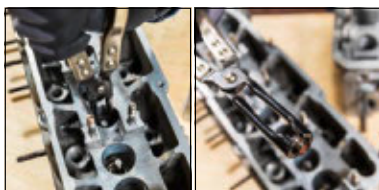

HAZET No.	l mm	EAN-No. 4000896+	€
791-8	270	061068	83,30

2991 Kleště na těsnicí kroužek ventilového dřívku

Made in Germany

• Funkční část s povrchem naneseným smáčením k zamezení poškození ventilového rozvodu



- Použití: **Stahování těsnění ventilového dřívku** speciálně na **BMW víceventilových motorech, OPEL, FORD, SEAT, ŠKODA a VW/AUDI**
- Tvrzené čelisti, podélné ozubení



HAZET No.	l mm	EAN-No. 4000896+	€
2991	250	018352	82,50

Palivové systémy / vstřikování

615 S Dvojitý očkový klíč

Made in Germany

• Možná práce v zabudovaném stavu



- Použití: Bezpečné ovládání šroubení regulační tyče (uvolnění, nastavení, utažení) při demontáži a montáži tlakové dózy se snímačem polohy pro ovladač plnicího tlaku na turbodmychadle
- Zahnutý dvojitý očkový klíč (dvojitý 6hran), bočně rýhovaný (s 10 mm)
- Použitelný v kombinaci s nástrčnou hlavici HAZET 2561-10
- Pro 2,0 l motory Common Rail (4válcový dieselový motor)
- **VW** Golf r.v. 2009 → · Golf Plus r.v. 2009 → · Eos r.v. 2006 → · Jetta r.v. 2006 → · Passat r.v. 2006 → · Passat CC r.v. 2009 → · Beetle r.v. 2011 → · Scirocco r.v. 2009 → · Tiguan r.v. 2008 → · Transporter r.v. 2010 →
- **AUDI** A3 r.v. 2004 → TT r.v. 2008 → 2014
- **SEAT** Altea r.v. 2006 → · León r.v. 2006 → 2012 · Toledo r.v. 2006 → 2009
- **ŠKODA** Octavia r.v. 2006 → 2013 · Superb r.v. 2009 → 2015 · Yeti r.v. 2009 →

2168-2 Nářadí k povolování palivového filtru

Made in Germany

• Bezproblémové použití i ve stísněných podmínkách



- Použití: Manipulace s krytem palivového filtru u motorů **FORD** Duratorq 2,2 TDCI
- Délka: 130 mm
- Vnější Ø: 160 mm
- **FORD** Transit Custom r. v. 04/2012 → · Tourneo Custom r. v. 04/2012 → · Transit r. v. 08/2013 →

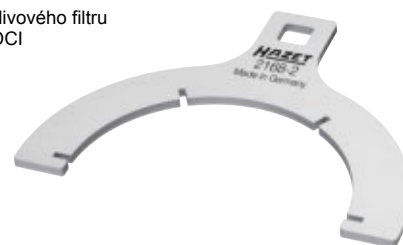

HAZET No.	Ø mm	EAN-No. 4000896+	€
2168-2	160	226870	10,30

2561 Nástrčná hlavice pro turbodmychadla · dvojitý 6hran

Made in Germany

• Možná práce v zabudovaném stavu



- Použití: Bezpečné ovládání šroubení regulační tyče (uvolnění, nastavení, utažení) při demontáži a montáži tlakové dózy se snímačem polohy pro ovladač plnicího tlaku na turbodmychadle
- Nástrčná hlavice (dvojitý 6hran), bočně rýhovaný
- Použitelná v kombinaci s dvojitým očko-plochým klíčem HAZET 615-S10x12
- Pro 2,0 l motory Common Rail (4válcový dieselový motor)
- **VW** Golf r.v. 2009 → · Golf Plus r.v. 2009 → · Eos r.v. 2006 → · Jetta r.v. 2006 → · Passat r.v. 2006 → · Passat CC r.v. 2009 → · Beetle r.v. 2011 → · Scirocco r.v. 2009 → · Tiguan r.v. 2008 → · Transporter r.v. 2010 →
- **AUDI** A3 r.v. 2004 → · TT r.v. 2008 → 2014
- **SEAT** Altea r.v. 2006 → · León r.v. 2006 → 2012 · Toledo r.v. 2006 → 2009
- **ŠKODA** Octavia r.v. 2006 → 2013 · Superb r.v. 2009 → 2015 · Yeti r.v. 2009 →
- DIN 3124, ISO 2725-1



YouTube Clip

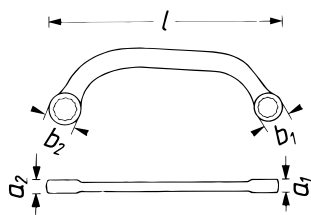
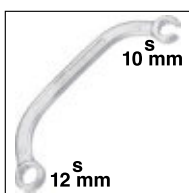

HAZET No.	l mm	a ₁ mm	a ₂ mm	b ₁ mm	b ₂ mm	EAN-No. 4000896+	€
615-S 10x12	147	7,5	7,5	18	20	203505	18,05



Speciální nářadí

Motor – Palivové systémy / vstřikování



2561 Nástrčná hlavice pro turbodmychadla · dvojitý 6hran



YouTube Clip

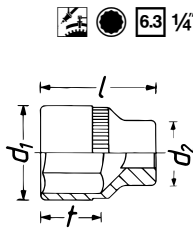

HAZET No.	s mm	l mm	d ₁ mm	d ₂ mm	t mm	EAN-No. 4000896+	€
2561-10	10	57	15	15	40	203512	25,65

2527-8 Nástrčná hlavice s kulovou hlavou

Made in Germany

- Použití: Snímač klepání u motoru V6 (s 8 mm)
- **Extra dlouhé provedení**
- S kulovou hlavou
- S rýhováním
- DIN 3124, ISO 2725-1

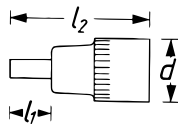

HAZET No.	s mm	l ₁ mm	l ₂ mm	d mm	EAN-No. 4000896+	€
2527-8	8	200	238	23	016310	27,45

4550 Klíč pro vstřikovací potrubí

Made in Germany

- **Nástrčná hlavice otevřený dvojitý 6hran**

- Použití: Ovládání šroubení u vstřikovacího vedení
- Povrch: chromováno
- DIN 3124, ISO 2725-1



HAZET No.	s mm	l mm	d ₁ mm	d ₂ mm	EAN-No. 4000896+	€
4550-5	14	119	27	22,9	149582	30,85
4550	17	115	-	-	021680	62,35
4550-1	17	120	-	-	021697	62,30
4550-2	19	119	-	-	021734	63,60

- Modely **FIAT · CITROËN · PEUGEOT · RENAULT** a **IVECO** s motory Common-Rail
- Rovněž šroubení vstřikovacích vedení např. na **BMW · MERCEDES-BENZ · VW**
- Ovládání **snímače teploty spalín** na dieselových motorech **VAG** od Euronorm 6
- **Dlouhé provedení**
- Pohon 12,5 = 1/2"

4550-5 14 119 27 22,9 149582 30,85

• Pro dieselové motory **BMW** a 2,5 TD motory **OPEL**

• Pohon 10 = 3/8"

4550 17 115 - - 021680 62,35

• **MERCEDES-BENZ** 100 · 130 · 314 · 360 · 360h · 352A · 346/355 · 401 · 402 · 403 · 407h · 615 · 616 · 617

• **Dlouhé provedení**

• Pohon 12,5 = 1/2"

4550-1 17 120 - - 021697 62,30

• **MERCEDES-BENZ** M 352 · A · 346/355 · A · 401 · 402/422 · LA · 403 · 407h, a také pro vodící trubku olejové měrky M 314

• **Dlouhé provedení**

• Pohon 12,5 = 1/2"

4550-2 19 119 - - 021734 63,60

4555 Nářadí na vstřikovací trysky

Made in Germany

- **Zvlášť podsoustružený** kvůli převlečení vývodů pro přepad

- Použití: Pro **vstřikovací trysky** (s 27 mm) u dieselových motorů

VW, AUDI, MERCEDES-BENZ, OPEL, FORD, PEUGEOT, Volvo, TOYOTA, MAZDA, NISSAN, MITSUBISHI, DAIHATSU

- Dlouhé provedení
- S rýhováním
- Povrch: chromováno
- DIN 3124, ISO 2725-1

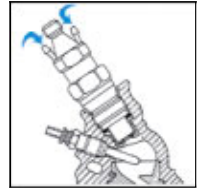

HAZET No.	s mm	l mm	d ₁ mm	d ₂ mm	t mm	EAN-No. 4000896+	€
4555 N	27	85	37,1	29,8	27,5	021840	42,10

Made in Germany

- Použití: Vstřikovací trysky (s 27 mm) u **BMW** s dieselovými motory
- M21 = E30 = 324TD · E28 = 524TD · E34 = 524TD
- M51 = E36 = 325TD · E34 = 525TDS, **FORD** Diesel **LINCOLN** Continental (USA), **LINCOLN** Mark 7 · VILISC

- Dlouhé provedení
- S rýhováním
- Povrch: chromováno
- DIN 3124, ISO 2725-1



HAZET No.	s mm	l mm	d ₁ mm	d ₂ mm	t mm	EAN-No. 4000896+	€
4555-1	27	85	37,1	29,8	27,5	021802	55,75

4556 Nářadí pro držák výtlačného ventilu

Made in Germany

- Použití: Vymontování a namontování **držáku tlakového ventilu** u vstřikovacího čerpadla MRSF-ERE
- Tisícíhraná nástrčná hlavice
- Pro dieselová osobní vozidla **MERCEDES-BENZ**, transportéry 601, 602, 603, 605, 606, 615, 616, 617
- 33 zubů

- Dlouhé provedení
- S rýhováním
- Povrch: chromováno
- DIN 3124, ISO 2725-1



HAZET No.	s mm	l mm	d ₁ mm	d ₂ mm	t mm	EAN-No. 4000896+	€
4556	17,9x20	55,5	24	23	15,5	021864	45,55

4560 Klíč pro vstřikovací potrubí

Made in Germany

- Použití: Montáž a demontáž **vstřikovacích potrubí** (s 17 mm)
- Na např. **VW, AUDI** dieselových motorech: 1,6 l 4-válc., 2,0 l 5-válc., 2,4 l 6-válc.

- Hodí se i pro ovládání **snímače teploty spalín** na dieselových motorech **VAG (VW · AUDI · SEAT · ŠKODA)** do normy Euro 5
- Povrch: chromováno



HAZET No.	s mm	l mm	EAN-No. 4000896+	€
4560	17x17	221	021918	39,80



4561 Nářadí pro vstřikovací čerpadla

Made in Germany

- Použití: Manipulace s **upevňovacími šrouby** (s 13 mm) u **vstřikovacího čerpadla**, při výměně ozubeného řemene resp. při nastavení počátku vstřiku
- Jednostranný očkový klíč
- Na 1,6 l 4-válc. -diesel **AUDI, VW** Golf, Jetta, Caddy, Passat, **CITROËN**
- Povrch: chromováno



HAZET No.	S mm	l mm	EAN-No. 4000896+	€
4561	13	165	021925	20,15

4561 Klíč pro turbodmychadla

Made in Germany

- **Jednostranný očkový klíč k manipulaci se šroubením turbodmychadla**
- Problém: velmi speciální šrouby, které se nedají s normálním běžným nářadím dosáhnout. **Řešení:** manipulace speciálně s dolními šrouby u filtru částic na turbodmychadle je nyní s tímto zvlášť zahnutým očkovým klíčem možná
- Pro: **AUDI** A4 (B5 · B6 · B7 · B8) · A6 (C5 · C6 · C8)
VW Passat (3B · 3BG · B6) s motorem 1,9 l a 2,0 l čerpadlo-tryska a filtrem částic
- Také pro přidržení šroubů na rozbočovací výfukové trubce **VW/AUDI** s 12 mm
- Povrch: chromováno



HAZET No.	S mm	l mm	EAN-No. 4000896+	€
4561-12	12	165	190485	22,35

4501 Kleště pro benzinové vedení

Made in Germany

- **Snadné ovládání rychlouzávěrů**
- Použití: Používá se při výměně palivového filtru nebo opravách motoru
- Např. pro **MERCEDES-BENZ · VW-AUDI · FIAT · OPEL · CITROËN**
- Motory **Volvo** D13 · D16 · **MAN** D3876 LF · D1556 LF · D2676 LF a také **SCANIA**
- Zemědělské stroje **CLAAS** s motorem MAN
- Vedení AdBlue a také vstřikovací tryska AdBlue
- Přímé provedení
- Ergonomické 2komponentní plastové kryty rukojetí HAZET (modrá/černá)



HAZET No.	l mm	EAN-No. 4000896+	€
4501-2	235	203499	47,65

4501 Kleště pro benzinové vedení

Made in Germany

- Použití: Manipulace s **rychlouzávěry s lehkým tlakem na palivové vedení a rovněž plnění nádrže**
- Na **FIAT/ALFA/LANCIA** vozidlech s 1,3 l – 1,9 l – 2,4 l dieselem, **CHRYSLER · RENAULT**
- **OPEL** (diesel): Vectra C/Signum 1,9 l diesel · Astra H 1,3 l a 1,9 l · Corsa C / Combo / Meriva 1,3 l
- **OPEL** (benzín): Corsa C · Astra G · Vectra C
- Plastová rukojeť

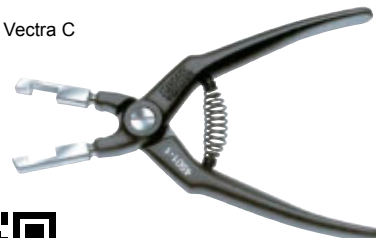

HAZET No.	l mm	EAN-No. 4000896+	€
4501-1	155	058624	24,70

4590 Kleště na sevření hadic

• **Sevření flexibilních hadic**

- Bezpečná aretace svíracím kroužkem
- Vysoce kvalitní plast

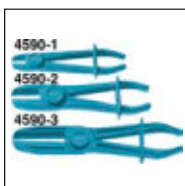

HAZET No.	l mm	EAN-No. 4000896+	€
4590-1	150	021932	20,45
4590-2	180	021949	30,05
4590-3	253	055753	35,05

4590 Sada svíracích kleští

• **Sevření flexibilních hadic**

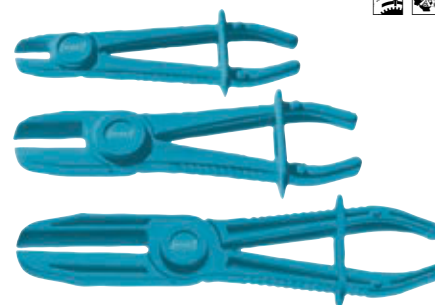

HAZET No.	l mm	EAN-No. 4000896+	€
4590/3	3	058266	56,55



Speciální nářadí

Motor – Palivové systémy / vstřikování



4591 Stop sada u potrubí

• Uzavírání potrubí a zamezení vytékání kapalin

- Použití: Uzavírání vedení v oblasti zařízení brzd, klimatizace, servořízení a palivového zařízení, které nelze zajistit svěrnými kleštěmi
- Uzávěr ve velikostech 6,3 mm (¼") · 8 mm (⅜") · 10 mm (⅝") a také pro dvojitý uzávěr (např. přípojky Banjo) ve velikosti 10 mm (⅝")



HAZET No.	EAN-No. 4000896+	€
4591/4	219650	21,15

2584-1 Nástrčná hlavice pro sací potrubí

• Made in Germany

- Použití: Šrouby na sacím potrubí
- Extra dlouhé provedení
- S rýhováním
- DIN 3124, ISO 2725-1



HAZET No.	S mm	l1 mm	l2 mm	EAN-No. 4000896+	€
2584-1	6	210	248	017058	24,40

4797 Vytahovák vstřikovačů

• Made in Germany

- Použití: Demontáž pevně usazených vstřikovačů Common-Rail bez demontáže hlavy válců



4797-1

YouTube Clip



4797-2

4797-3

4797-9

4797 Vytahovák vstřikovačů



HAZET No.	l mm		EAN-No. 4000896+	€
<ul style="list-style-type: none"> • Např. pro MERCEDES-BENZ motory CDI 611 · 612 · 613 atd. • Speciálně přizpůsobené pro použití v úzkém prostoru podmíněném výkem hlavy válců 				
4797/2	460	2	121205	236,90
<ul style="list-style-type: none"> • Rázový vytahovací přístroj • M 16 x 1,5 • Rázová hmotnost: 1,8 kg 				
4797-1	460	-	121175	114,70
<ul style="list-style-type: none"> • Hák na vstřikovače • M 16 x 1,5 				
4797-2	130	-	121182	137,90
<ul style="list-style-type: none"> • Vnější adaptér s vnitřním závitem M16 x 1,5 na M 27 x 1 • Demontáž vstřikovačů Bosch s vnějším závitem M 27 x 1 • Ve spojení s rázovým vytahovákem 4797-1 • Způsob funkce: Vnější adaptér se používá, když z konstrukčních nebo prostorových důvodů nelze použít vytahovací hák. Upozornění: Po demontáži vstřikovače pomocí vnějšího adaptéru se musí vstřikovač vyměnit za nový 				
4797-3	50	-	121199	30,15
<ul style="list-style-type: none"> • Hák na piezo vstřikovače • Demontáž piezovstřikovačů na motorech MERCEDES-BENZ OM 651 • Optimální uchycení vstřikovače díky vyladěnému provedení háku na vstřikovače • MERCEDES-BENZ: třída A typ 176 · třída B typ 246 · třída C typ 204, 205 třída E typ 212 · třída S typ 221, 222 · třída V typ 639, 447 CLA typ 117 · GLA typ X156 · GLK typ X204 CLS typ 218 · ML typ 166 · SLK/SLC typ 172 · GLC typ X253 • Manipulace s rázovým vytahovákem HAZET 4797-1 • Vnitřní závit: M16 x 1,5 mm 				
4797-9	54,5	-	206667	60,95

4797 Sada pro opravu závitů u upevňovacích šroubů vstřikovačů

• Made in Germany

- Pro motory MERCEDES-BENZ CDI se zlomenými pružnými šrouby M 6 x 1 z hlavy válců bez demontáže ventilového víka vyvrtáním
- Enormní úspora nákladů a času, protože odpadá oprava hlavy válců, demontáž vstřikovačů a víka ventilů
- Poškozené závitů budou předělány na M8 x 1

Obsah:

- 1 spirálový vrták 6 mm s distančním pouzdrem
- 1 závitový vrták M8 x 1
- 1 vrtací pouzdro
- 1 spirálový vrták 7 mm s distančním pouzdrem a vodící trubkou
- 1 zakrucovací hlavice
- 5 závitových vložek M6 x 1
- SmartCase (1/9) 165-S
- Safety-Insert-System, 2komponentní vložka z měkké pěny.
- Vložka vhodná také pro HAZET-Assistent

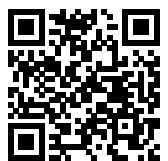

YouTube Clip

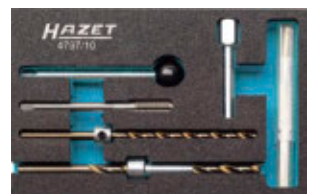

1/9			
-----	--	--	--



HAZET No.	d x š x v mm		EAN-No. 4000896+	€
4797/10	185 x 153 x 52	10	191505	305,90
<ul style="list-style-type: none"> • Závitové vložky · 5 kusů M 6 x 1 pro 4797/10 				
4797-M 6x1/5	-	5	192441	47,90



4798 Univerzální sada nástrojů na vytahování vstřikovačů

- Umožňuje demontáž vstřikovačů bez odstranění elektrických konektorů nebo hlavy vstřikovačů
- Výhoda: bez předchozí závady vstřikovače je možná opětná montáž bez nové kalibrace



- Použití: Vytahování dieselových vstřikovačů značek Bosch, Delphi, Siemens, Denso pomocí rázového kladiwa
- Univerzální sada
- Obsah pro demontáž podle tvaru a prostoru:
 - 1 speciální kleště pro uchopení v drážce pro uchycení vstřikovače
 - 2 rukojeti s kloubovým adaptérem pro současně vytahování a protáčení vstřikovače. Rukojeti lze volitelně připevnit na vnitřním nebo vnějším závitu přípojky pro přívod paliva
 - 1 speciální adaptér Bosch pro bezpečné uchopení vstřikovačů a zaručené rovnoměrné přenášení síly
- SmartCase (1/3) 165-L
- Safety-Insert-System, 2komponentní vložka z měkké pěny. Vložka vhodná také pro HAZET-Assistent



YouTube Clip



HAZET No.	d x š x v mm		EAN-No. 4000896+	€
4798-6/8	355x235x65	8	210763	479,30

4798 Univerzální sada nástrojů na vstřikovače Denso

- Umožňuje demontáž vstřikovačů bez odstranění elektrických konektorů nebo hlavy vstřikovačů



- Použití: Pro vstřikovače Denso: 23670 → 30080 · MB416600 → MB40A · 5870 → 13H50B · 11L 12182 · 23670 → 26011 · 23670 → 0R050 · 10J 06798
- Zabudované např. na vozech: TOYOTA · NISSAN · MAZDA · OPEL / VAUXHALL · LEXUS
- Stahovací systém uchopuje bezpečně přes přípojku napájení a přepadu
- Včetně 5 adaptérů na vstřikovače a rázového kladiwa
- Je možná snadná demontáž vstřikovače pomocí rázového kladiwa
- Rychlé přiřazení párů ramen díky dodanému návodu
- Plastová skříňka
- 2komponentní měkká pěnová vložka



YouTube Clip

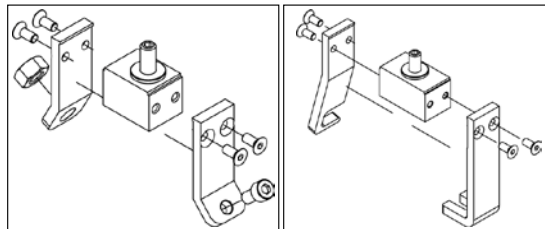

HAZET No.		EAN-No. 4000896+	€
4798-7/14	14	210756	555,-





Speciální nářadí

Motor – Palivové systémy / vstřikování



4798 Nástrčná hlavice na vstřikovače Siemens s 25 mm

- Přesně vyladěná na elektrickou jednotku vstřikovače
- Použití: Demontáž elektrických konektorů na vstřikovačích Siemens
- Ve spojení s např. HAZET 4798-5/25 a 916 HP



HAZET No.	S mm	EAN-No. 4000896+	€
4798-15	25	210640	75,60

4798 Nástrčná hlavice na vstřikovače Siemens s 27 mm

- Přesně vyladěná na elektrickou jednotku vstřikovače
- Použití: Demontáž elektrických konektorů na vstřikovačích Siemens
- Ve spojení s např. HAZET 4798-5/25 a 916 HP



HAZET No.	S mm	EAN-No. 4000896+	€
4798-16	27	210657	75,60

4798 Nástrčná hlavice na vstřikovače Bosch s 28 mm

- Přesně vyladěná na elektrickou jednotku vstřikovače
- Použití: Demontáž elektrických konektorů na vstřikovačích Bosch
- Ve spojení s např. HAZET 4798-5/25 a 916 HP



HAZET No.	S mm	EAN-No. 4000896+	€
4798-17	28	210664	75,60



4798 Nástrčná hlavice na vstřikovače Bosch s 29 mm

- Přesně vyladěná na elektrickou jednotku vstřikovače
- Použití: Demontáž elektrických konektorů na vstřikovačích Bosch
- Ve spojení s např. HAZET 4798-5/25 a 916 HP

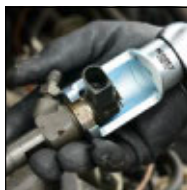

HAZET No.	S mm	EAN-No. 4000896+	€
4798-13	29	210527	75,60

4798 Nástrčná hlavice na vstřikovače Bosch s 30 mm

- Přesně vyladěná na elektrickou jednotku vstřikovače
- Použití: Demontáž elektrických konektorů na vstřikovačích Bosch
- Ve spojení s např. HAZET 4798-5/25 a 916 HP

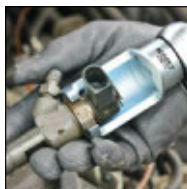

HAZET No.	S mm	EAN-No. 4000896+	€
4798-14	30	210633	75,60

4798 Speciální nástrčná hlavice pro šroubení magnetického ventilu

- Čelní otvor v profilu klíče umožňuje přístup k závitovému prstenci
- Použití: Demontáž šroubení magnetického ventilu na vstřikovačích Bosch
- Pohon s vnějším šestihranem s 19 mm
- Ve spojení s např. HAZET 4798-5/25 a 916 HP

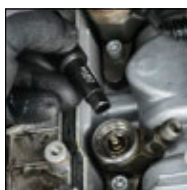

HAZET No.	S mm	EAN-No. 4000896+	€
4798-18	10	210695	39,60



Univerzální sada nástrojů pro demontáž vstřikovačů · mechanická s adaptérem Bosch

4798 Enormní časová úspora, neboť se nemusí vymontovat ani hlava válců, ani motor



- Použití: Demontáž velmi pevně usazených vstřikovačů
- Usnadněné uvolnění vstřikovačů, které lze kvůli silnému zkoksování, resp. rzi vytáhnout pouze s enormním vynaložením síly
- Podpěrný můstek Heavy Duty lze individuálně přizpůsobit nabídce místa a možnostem podepření na hlavě válců
- Tažné vřetenno M18 a tlačné ložisko zaručují vysoké tažné síly
- Dodání včetně spojovacího adaptéru pro vstřikovače s magnetickými ventily Bosch
- Demontáž vstřikovačů Siemens, Denso a Delphi s pomocí volitelně dostupného příslušenství
- Lze volitelně rozšířit hydraulickým válcem, např. HAZET č. 4798-9/6 nebo 4798-20
- Plastová skříňka
- 2komponentní měkká pěnová vložka



YouTube Clip

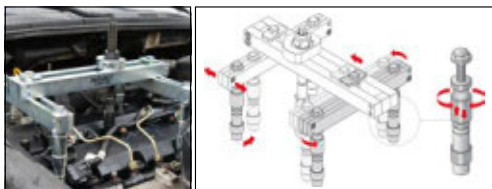

HAZET No.	d x š x v mm		EAN-No. 4000896+	€
4798-5/25	490x410x120	25	210688	886,-

4798 Sada adaptérů vstřikovačů RENAULT

• Zajišťuje rovnou dosedací plochu pro nástroje na vstřikovače k provedení optimálního procesu demontáže vstřikovačů



- Použití: Pro motory RENAULT 2,0 dCi M9R s piezoelektrickými vstřikovači
- Rozšiřující sada se speciálními podpěrnými traverzami a tažným vřetenem
- Použití s HAZET 4798-5/25



HAZET No.		EAN-No. 4000896+	€
4798-12/13	13	210701	141,-

4798 Adaptérová deska RENAULT

• Boční montáž desky na motor zajistí rovnou dosedací plochu pro HAZET 4798-5/25



• Použití: Pro RENAULT · OPEL · NISSAN 2,2 → 2,5 dCi / kód motoru G9T, G9U



HAZET No.	EAN-No. 4000896+	€
4798-22	210510	100,40

4798 Sada adaptérů vstřikovačů Siemens

• Umožňuje dílčí rozebrání vstřikovače a tím přímé spojení s tažným vřetenem



- Použití: Pro demontáž vstřikovačů Siemens M 25 x 1 a M 14 x 1
- Použití s HAZET 4798-5/25



HAZET No.		EAN-No. 4000896+	€
4798-21/2	2	210770	80,15

4798 Sada adaptérů vstřikovačů Denso

• Umožňuje dílčí rozebrání vstřikovače a tím přímé spojení s tažným vřetenem



- Použití: Pro demontáž vstřikovačů Denso M 25 x 0,75 a M 25 x 0,5
- Použití s HAZET 4798-5/25



HAZET No.		EAN-No. 4000896+	€
4798-10/3	3	210725	145,60



Speciální nářadí

Motor – Palivové systémy / vstřikování



4798 Mechanický hydraulický válec 12 tun

• Ekonomicky výhodné, neboť není potřeba hydraulické čerpadlo



- Velmi malá konstrukční výška pouhých 45 mm
- Vřetenové matice M 10 · M 12 · M 14 · M 16 · M 18 obsažené v sadě
- Protiskluzová rukojeť
- Hliníkový válec s nízkou hmotností
- Zdvih: 8 mm
- Střížný kolík na vřetenovém pohonu chrání před přetížením
- Použití s univerzální sadou nástrojů pro demontáž vstřikovačů HAZET 4798-5/25.
- Ovládání očko-plochým klíčem, např. HAZET 600N-19
- SmartCase (1/3) 165-L
- Safety-Insert-System, 2komponentní vložka z měkké pěny. Vložka vhodná také pro HAZET-Assistent



4798 Nástroj pro demontáž vstřikovačů MERCEDES-BENZ · Bosch / Delphi

• Enormní časová úspora, neboť se k demontáži vstřikovačů nemusí vymontovat motor



- Použití: Usnadněné uvolnění velmi pevně usazených vstřikovačů 12 tunovým hydraulickým válcem
- Pro MERCEDES-BENZ 2,1 l · 2,2 l · 3,0 l V6 (CDI 2,1 l · 2,2 l Delphi · CDI 3,0 l V6 Bosch) · Vito · CLK · Sprinter · Viano · Vario a rovněž M · GL · C · GLK · E · CLS · S · R · třída G · CHRYSLER 3,0 l V6
- Ovládání hydraulického válce např. pomocí HAZET 600N-19
- SmartCase (1/3) 165-L
- Safety-Insert-System, 2komponentní vložka z měkké pěny. Vložka vhodná také pro HAZET-Assistent



YouTube Clip



HAZET No.	d x š x v mm		EAN-No. 4000896+	€
4798-9/6	355x235x65	9	210732	712,-

HAZET No.	d x š x v mm		EAN-No. 4000896+	€
4798-8/8	355x235x65	8	210749	1016,-



4798 Hydraulický válec 20 tun

- Použití: Pro velmi pevně usazené vstřikovače
- Pracovní tlak: 700 barů
- Hmotnost: 3,04 kg
- Zdvih: 8 mm
- Rozměry: 100x60 mm
- Ve spojení s hydraulickou nožní pumpou, např. HAZET 4932N-100 a HAZET 4798-5/25

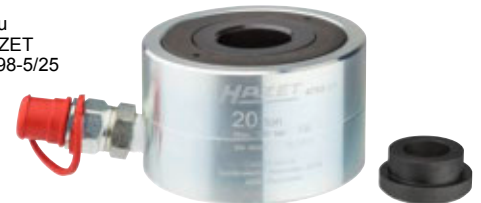

HAZET No.	EAN-No. 4000896+	€
4798-20	210718	527,-



Chladicí systém / hadicové spojení

798 Kleště na hadicové spony

Made in Germany

- Použití: Jednoduché hadicové spony např. u mycích strojů
- **Otočné čelisti** – pro stísněné prostorové podmínky
- Povrch: chromováno



HAZET No.	l mm	sb mm	EAN-No. 4000896+	€
798	206	40	031832	40,15

Made in Germany

• **Aretace, nastavitelné rozvření**

- Použití: Jednoduché hadicové spony
- **Otočné čelisti** – pro stísněné prostorové podmínky
- Povrch: chromováno



HAZET No.	l mm	sb mm	EAN-No. 4000896+	€
798-1	285	45	031900	76,55

798 Kleště na hadicové spony Clic

Made in Germany

- Použití: Opětovně použitelné hadicové spony typu CLIC na vedeních paliva
- Např. u **VW · AUDI · OPEL · PEUGEOT a ALFA**
- Odjistění a uzavření spony otočením kleští o 180°
- Pevné čelisti, zahnuté o 90°



YouTube Clip



HAZET No.	l mm	sb mm	EAN-No. 4000896+	€
798-2	175	20	051397	54,95

798 Kleště na hadicové spony

Made in Germany

- Použití: Manipulace s opakovaně použitelnými hadicovými sponami typu CLIC
- **AUDI · VW · OPEL · PEUGEOT · SMART a MERCEDES-BENZ**
- Odjistění a uzavření otočením kleští o 180°
- **Otočné čelisti** – pro stísněné prostorové podmínky
- Povrch: niklováno

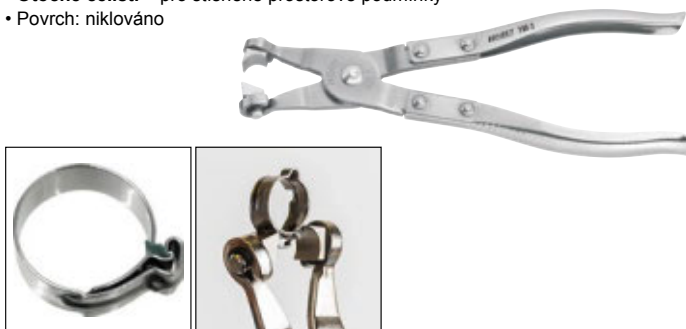

HAZET No.	l mm	sb mm	EAN-No. 4000896+	€
798-3	206	35	102433	55,95

Made in Germany

- Použití: Samoupínací pružné upínací spony
- **Otočné čelisti** – pro stísněné prostorové podmínky



HAZET No.	l mm	sb mm	EAN-No. 4000896+	€
798-4	205	35	031948	56,15

Made in Germany

- Použití: Pro pružné upínací spony např. na **VW, AUDI a OPEL**
- **Otočné čelisti** – pro stísněné prostorové podmínky



HAZET No.	l mm	sb mm	EAN-No. 4000896+	€
798-5	210	6-40	031955	44,60

798 Hadicové spony, kleště

Made in Germany

- Použití: Pro pružné upínací spony 12 a 15 mm široké, 13 – 22 mm Ø
- **Otočné bezpečnostní čelisti**





Speciální nářadí

Motor – Chladicí systém / hadicové spojení



798 Kleště na hadicové spony



YouTube Clip



E

HAZET No.	l mm	sb mm	EAN-No. 4000896+	€
798-6	235	39	031962	92,40

Made in Germany



E

• Práce bez vynaložení velké síly také na velkých pružných sponách díky samonastavitelnému kloubu

- Použití: Pro samoupínací pružné spony 12 a 15 mm široké
- Aretace
- Samonastavitelný kloub
- Otočné bezpečnostní čelisti
- Rukojeť s povrchovou úpravou máčením



HAZET No.	l mm	sb mm	EAN-No. 4000896+	€
798-8	290	45	076697	103,70

Made in Germany



• Aretace

- Použití: Zejména pro pružné upínací spony o šířce 12 a 15 mm, např. u systému chlazení a vytápění
- Otočné čelisti, zahnuté v úhlu 110° – pro stísněné prostorové podmínky
- Rukojeť s povrchovou úpravou máčením

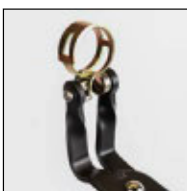

YouTube Clip

HAZET No.	l mm	sb mm	EAN-No. 4000896+	€
798-9	250	60	072163	79,30

798 Kleště na hadicové spony

Made in Germany



E

• Aretace

- Použití: Pro spony pružinových pásů – zejména pro pružné upínací spony o šířce 12 mm a 15 mm, např. u vozidel OPEL, VW, FORD, RENAULT, FIAT, PEUGEOT, CITROËN, PORSCHE, ALFA-ROMEO, MERCEDES-BENZ, SMART
- Nastavitelné rozevření
- Pevné čelisti



HAZET No.	l mm	sb mm	EAN-No. 4000896+	€
798-10	320	90	031917	146,90

Made in Germany



E

• Aretace

- Použití: Samoupínací pružné upínací spony
- Nastavitelné rozevření
- Rukojeť s povrchovou úpravou máčením



HAZET No.	l mm	sb mm	EAN-No. 4000896+	€
798-12	320	80	031931	161,70

Made in Germany



• Použití i ve stísněných prostorách, u kterých nelze na objímku dosáhnout přímo

- Použití: Manipulace s pružnými svorkami, jejichž tři konce leží přímo na hadici, např. na hadicích pro odvětrání nádrže a benzinových hadicích na VW, AUDI, SEAT a ŠKODA
- Otočné čelisti – pro stísněné prostorové podmínky



HAZET No.	l mm	sb mm	EAN-No. 4000896+	€
798-13	192	27	155248	65,30



798 Kleště na hadicové spony

Made in Germany

- Použití: Manipulace s pružinovými pásovými sponami, jejichž tři konce jsou přímo u hadice
- Např. u benzínových hadic a hadic pro odvětrání nádrže u VW · AUDI · SEAT · ŠKODA
- Povrch: niklováno



HAZET No.	l mm	sb mm	EAN-No. 4000896+	€
798-14	177	8–20	109128	52,55

Made in Germany

- Díky lanovodu (610 mm) lze používat i ve velmi úzkém prostoru, který nedovoluje přímé použití kleští



- Použití: Manipulace se samonapínacími pružnými upínacími sponami a sponami k úspoře místa sb Ø 7–60 mm, např. v oblasti chladicích a topných systémů
- Snadné ovládání díky automatické vícenásobné aretaci
- Posuvné vedení s integrovanou napínací pružinou a nastavitelnou oboustrannou deskou
- Rukojeť s povrchovou úpravou máčením

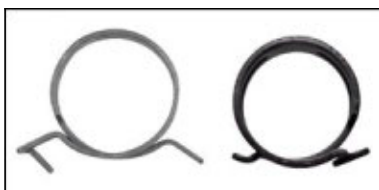

HAZET No.	l mm	sb mm	EAN-No. 4000896+	€
798-15 A	875	7–60	097258	151,60

- Lankové táhlo · kompletní
Lankové táhlo · opláštění · 2 stavěcí šrouby · pružina pro 798-15 A
- 798-0151 A – – 097753 39,20
- Lankové táhlo pro 798-15 A a B
- 798-0152 A – – 097760 14,50
- Posuvné vedení pro 798-15 A a B
- 798-0153 A – – 097784 21,60

798 Kleště na hadicové spony

Made in Germany

- Vhodné zejména ve velmi stísněném prostoru, kde není možné přímé použití kleští



- Použití: Ovládání samoupínacích pružinových a prostorově úsporných svorek v oblasti chladicího a topného systému
- Pláštěm opláštěné, polopružné bowdenové táhlo
- Bowdenové táhlo umožňuje práci bez vedení rukou
- Posuvné vedení s integrovanou napínací pružinou a nastavitelnou oboustrannou deskou
- Snadné ovládání díky automatické vícenásobné aretaci
- Rukojeť s povrchovou úpravou máčením



HAZET No.	l mm	sb mm	EAN-No. 4000896+	€
798-15 B	875	7–60	117727	170,20
• Flexibilní hadice pro 798-15 B				
798-0150 B	–	–	142439	47,90
• Lankové táhlo pro 798-15 A a B				
798-0152 A	–	–	097760	14,50
• Posuvné vedení pro 798-15 A a B				
798-0153 A	–	–	097784	21,60

Made in Germany

- Zesílené bowdenové táhlo a posuvné vedení



- Použití: Speciální spona s paralelně ležícím koncem spony např. u hrdla chladiče plnicího vzduchu u VW Passat nebo T5
- Bowdenové táhlo lze používat i ve stísněných prostorech
- Vícenásobná aretace a ovládání jednou rukou
- Uvolnění aretačního zařízení pomocí tlačné páčky v oblasti úchopu
- Rukojeť s povrchovou úpravou máčením



HAZET No.	l mm	sb mm	EAN-No. 4000896+	€
798-16	875	3–50	149032	157,70
• Lankové táhlo pro 798-16				
798-0162	–	–	149056	10,35
• Posuvné vedení pro 798-16				
798-0163	–	–	149063	48,60



Speciální nářadí

Motor – Chladicí systém / hadicové spojení



798 Kleště na hadicové spony

Made in Germany

- Použití: Manipulace se samopínacími **prostorově úspornými sponami** na hadicích chlazení a u palivových hadic v celém prostoru vozidla, zejména u **VW, AUDI, SEAT, ŠKODA**
- **Otočné čelisti** – pro stísněné prostorové podmínky

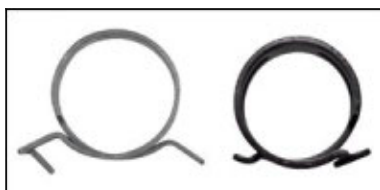
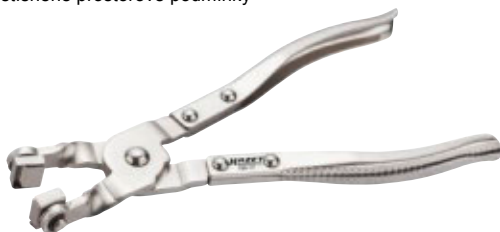

HAZET No.	l mm	sb mm	EAN-No. 4000896+	€
798-17	210	40	186068	47,10

798 Sada kleští na hadicové spony

Made in Germany

- Safety-Insert-System, 2komponentní vložka z měkké pěny. Vložka vhodná také pro HAZET-Assistent

1/3				
-----	--	--	--	--



HAZET No.	d x š mm	l mm	□	EAN-No. 4000896+	€
798					
798-3 • 798-13 • 798-17					
163-425/3	342x172	342	3	202614	149,-

4562 Ovládací nástroj svorky Henn

Made in Germany

- Přesazení rukojeti o 90° umožňuje ovládání i na obtížně přístupných svorkách Henn



4562-2

4562-2

4562 Ovládací nástroj svorky Henn

HAZET No.	l mm	EAN-No. 4000896+	€
• Svorky Henn s 2 manipulačními otvory u západkové pružiny			
• Šířka: 20 mm (ve funkčním rozsahu)			
4562-1	100	222353	31,75
• Svorky Henn s 1 manipulačním otvorem u západkové pružiny			
• Šířka: 20 mm (ve funkčním rozsahu)			
4562-2	99	235476	31,75

4801 Podtlaková plnička chladicí směsi

Made in Germany

- **Použitelný ve spojení se samostatnými nebo univerzálními adaptéry programu HAZET testerů chladicích systémů 4800, jakož i se setem kuželů 4801-2/3**



- Použití: Vakuová zkouška těsnosti chladicího systému před plněním
- Plnění bez tvorby bublinek
- Rychlospojkový systém
- Odpadá dodatečné odvzdušnění
- Lze použít téměř u všech typů vozidel
- Včetně pokynů pro používání

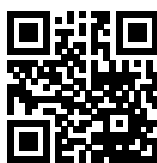

YouTube Clip

HAZET No.	EAN-No. 4000896+	€
4801-1	148806	203,20

4801 Sada kónusů pro expanzní nádobu chladiče

Made in Germany

- **Univerzální sada k nasazení na nádobu chladiče / expanzní nádobu**



- Použití ve spojení s podtlakovou plničkou chladičů HAZET 4801-1
- Vytvořený podtlak drží vhodný gumový kužel v chladiči, resp. v otvoru vyrovnávací nádrže chlazení

3dílná sada, obsah:

3 pryžové kužele s funkčním Ø 17–31 / 24–39 / 34–50 mm



YouTube Clip

HAZET No.	□	EAN-No. 4000896+	€
4801-2/3	3	152407	86,55



Diagnostika



Použití výrobku
Přiřazení adaptérů pro chladiče
 hazet.de → Servis → Poradce pro použití
 → Přiřazení adaptérů pro chladiče 4800
 ◀ Pro smartphony s aplikací QR Reader

4800 Tester chladicího systému

Made in Germany

- Použití: Kontrola netěsností v chladicích systémech a topných okruzích
- Přiřazení k typům vozidel: www.hazet.de → **Poradce pro použití** → **Adaptér chladiče 4800**

• Plastová skříňka

• Použití u vozidel **AUDI** A2 · A3 · A4 · A5 · A6 · A7 A8 · TT · **VW** Passat · Golf 4 · 5 · Lupo (r.v. 1998 →) · Vento · Jetta · EOS · Bora · T5 · **CITROËN** C2 · C3 · C4 · C5 · C6 · C8 · Jumper · Jumpy · **FIAT** Tipo · Tempra · **MERCEDES-BENZ** typ 202 / 203 (třída C) · 124 / 210 (třída E) · 129 / 220 (třída S) · 251 (třída R) · 164 (třída M) · **NISSAN** Micra · **OPEL** Vectra C · Astra H · Zafira A · Meriva · Signum · Corsa · **PEUGEOT** · **RENAULT** Safrane · Mégane · Laguna · Twingo · Trafic · Master · **SEAT** Arosa · Córdoba · Ibiza · Toledo · León · **ŠKODA** Octavia · Fabia · Roomster

Obsah sady:

4800-1 · 4800-2

4800-4 A · 6 A · 12 A · 15 · 17



HAZET No.		EAN-No. 4000896+	€
4800/7	7	132874	464,20

4800 Tester chladicího systému

Made in Germany

- Použití: Kontrola netěsností v chladicích systémech a topných okruzích
- Přiřazení k typům vozidel: www.hazet.de → **Poradce pro použití** → **Adaptér chladiče 4800**
- Plastová skříňka

• Obsah sady

4800-1 · 4800-2

4800-3 · 4 A · 5 A · 6 A · 7 A · 8 A · 12 A · 13 A · 17 · 22 · 23



HAZET No.		EAN-No. 4000896+	€
4800/12	12	165483	764,-

4800 Pumpa pro natlakování chladiče

Made in Germany

- Použití: Kontrola netěsností v chladicích systémech a topných okruzích
- K použití s adaptéry chladiče série HAZET 4800



HAZET No.	EAN-No. 4000896+	€
4800-1	022243	111,10
4800-2	022274	32,05

4800 Pumpa pro natlakování chladiče a adaptéry pro chladiče

Made in Germany

- Použití: Kontrola netěsností v chladicích systémech a topných okruzích
- Závit přesně přizpůsobený otvoru vyrovnávací nádoby (bajonetový uzávěr u 4800-3 · 10 · 11 · 16 · 22 · 23)
- Se spojovací vsuvkou pro napojení na rychlospojku tlakovací pumpy na chladiče 4800-1 a mezikus 4800-2 nebo vakuový plnicí přístroj HAZET 4801-1 a 4802-1



HAZET No.	EAN-No. 4000896+	€
4800-3	022281	26,20

Adaptér chladiče STANDARD (s bajonetovým uzávěrem) pro:

- **osobní vozidla:**
 - FIAT
 - KIA
 - MERCEDES-BENZ Vito · Viano · Solaris
 - MITSUBISHI
 - PORSCHE
 - SUZUKI Vitara · Samurai
- **Užitkové vozy / zemědělské stroje:**
 - AMAZONE Pantera
 - CASE Magnum, Quadtrac
 - CLAAS Jaguar, Lexion, Scorpion, Ares, Atlas, Ceres, Arion
 - DAF 45 r. v. 05/1991 → 12/2000
 - DOOSAN kolové rýpadlo S · pásové rýpadlo DX
 - FENDT
 - KAESER Mobilair
 - LIEBHERR A308-316
 - MASSEY FERGUSON s nádrží číslo 180224M92 a 4296015M1
 - NISSAN vysokozdvizný vozík
 - PUTZMEISTER BSA 1409
 - SCANIA Vabis



4800 Pumpa pro natlakování chladiče a adaptéry pro chladiče



HAZET No.	FAN-No. 4000836+	€
Adaptér chladiče (slouží současně jako adaptér pro adaptér chladiče HAZET bez připojovací vsuvky) pro:		
• osobní vozidla: <ul style="list-style-type: none"> - ALFA ROMEO 147 · 164 · 166 · GT · Mito - CITROËN Berlingo r. v. 1998 → · C1 HDi · C2 · C3 · C4 · C5 · C6 · C8 · Jumper · Jumpy · Nemo · Picasso - DACIA Dokker · Duster · Lodgy · Logan · Sandero - FERRARI Závitový uzávěr - FIAT 500 r. v. 2007 → · Bravo · Dobló · Ducato · Fiorino · Grande Punto · Idea · Linea · Multipla · Panda · Punto · Qubo · Scudo · Seicento · Stilo · Tempra · Tipo · Ulysse - FORD Ka r. v. 2009 → - LANCIA Delta · Musa · Phedra · Thesis · Ypsilon - LAND ROVER Defender TD5 · Freelander 2,0 DI - MASERATI Závitový uzávěr - MERCEDES-BENZ Citan - MINI Mini r. v. 2007 → - MITSUBISHI Carisma D r. v. → 2003 · Space Star D - NISSAN Interstar · Kubistar · Micra · Primastar · Quashqai - OPEL Combo D · Crossland X · Grandland X · Movano · Zafira Life - PEUGEOT 206 · 207 · 307 r. v. 2004 → · 308 · 406 · 807 r. v. 2004 → · Expert · Partner - RENAULT Avantime · Espace · Master · Mégane · Laguna · Trafic · Twingo - Volvo 850 · 960 · C 70 r. v. → 2007 · S 40 r. v. → 2003 · S 60 r. v. → 2007 · S 80 r. v. → 2007 · V 40 r. v. → 2003 · V 70 r. v. → 2007 · XC 90 r. v. → 2007 		
• Užitékové vozy / zemědělské stroje: <ul style="list-style-type: none"> - CASE CVX · Maxxum · Optum · Puma CS, SBS, LBS - CLAAS Arion · Axion - DEUTZ Motory 3,6 PowerPack · BF6M1013FC · TCD2013L6 2V a 4V · Genset 250kVA - FENDT Vario r. v. 2000 → · kombajn řady L - FIAT M100 · 115 · 135 · 165 - HATZ 4H50tc - IVECO Eco Daily s modrým uzávěrem - NEW HOLLAND T6 · T7, T7 Elite Pack · TVT 		
4800-4 A	156504	37,75
Adaptér chladiče pro		
• osobní vozidla: <ul style="list-style-type: none"> - AUDI - PORSCHE 986 · 987 · 996 · 997 · Cayman · Carrera GT - SMART For Two · Roadster - VW Golf 2 · Transporter T3 		
• Užitékové vozy / zemědělské stroje: <ul style="list-style-type: none"> - COMPAIR Mobil kompresor s vyrovnávací nádrží VW - FENDT Farmer 300 r. v. 1988 → · typ 500 · typ 700 · Vario r. v. 1988 → - LINDE vysokozdvizný vozík - RENAULT Midlum r. v. 01/2000 → 12/2013 - PUTZMEISTER BSA 1407D · BSA 2110 HP-D - Volvo FE r. v. 05/2006 → · FL r. v. 03/2000 → 		
4800-5 A	161843	41,55
Adaptér chladiče pro		
<ul style="list-style-type: none"> • VW Passat · T4 · Lupo r.v. 1998 → SEAT Arosa · Córdoba · Ibiza r.v. 1999 → SEAT Vario a León r.v. → 1998 ŠKODA Octavia r.v. → 1998 		
4800-6 A	161850	55,35
Adaptér chladiče pro		
• osobní vozidla: <ul style="list-style-type: none"> - CHEVROLET - DAEWOO/CHEVROLET - FORD Ka · Focus r. v. → 2007 · Fusion · Mondeo - OPEL Agila · Zafira A 		
• Užitékové vozy / zemědělské stroje: <ul style="list-style-type: none"> - MAN Tga · L 2000 		
4800-7 A	161867	49,55
Adaptér chladiče pro		
<ul style="list-style-type: none"> • BMW řada 3 → r.v. 2008 · řada 5 → r.v. 2003 · řada 7 → r.v. 2001 · X3 → r.v. 2010 · X5 → r.v. 2013 		
4800-8 A	161874	59,35
Adaptér chladiče pro		
<ul style="list-style-type: none"> • BMW řada 3 r. v. → 2000 · Z1 · Z3 · Z4 r. v. → 2013 ROVER Range-Rover 		
4800-9 A	161881	67,90





4800 Adaptér pro chladiče

Made in Germany

- Použití: Kontrola netěsnosti v chladicích systémech a topných okruzích
- Rozšíření sortimentu pro stávající tester chladicího systému HAZET 4800**
- Závit přesně přizpůsobený otvoru vyrovnávací nádoby
- Se spojovací vsuvkou pro napojení na rychlospojku tlakovací pumpy na chladiče 4800-1 a mezikus 4800-2 nebo vakuový plnicí přístroj HAZET 4801-1 a 4802-1



HAZET No.	EAN-No. 4000896+	€
Adaptér chladiče (s bajonetovým uzávěrem) pro • RENAULT		
4800-10	022250	31,35
Adaptér chladiče (s bajonetovým uzávěrem) pro • SMART For Four · FORD · KIA • Japonská vozidla		
4800-11	022267	33,75
Adaptér chladiče pro • AUDI A1 (r. v. 2010 →) · A2 · A3 · A4 · A5 r. v. 2007 → · A6 · A8 · TT · Q5 · Q7 · R8 • VW Passat B5 · Eos · Bora · T5 · LT · Golf 4 · 5 · 6 · 7 · Vento · Jetta • SEAT Toledo · León • ŠKODA Octavia · Fabia r. v. 1998 → · Roomster · Superb • PORSCHE Cayenne · Panamera • MULTICAR M27		
4800-12 A	161898	85,80
Adaptér chladiče pro • VW Sharan • FORD Galaxy • SEAT Alhambra		
4800-13 A	161904	73,25
Adaptér chladiče pro • MERCEDES-BENZ typ 168 · 169 (třída A) · 245 (třída B) · CDI · 220 · 129		
4800-14	079018	73,55
Adaptér chladiče pro • MERCEDES-BENZ typ 202 / 203 (třída C) · typ 204 (třída C) typ 124 / 210 / 211 (třída E) · typ 129 / 220 (třída S) · typ 164 (třída M) · typ 251 (třída R) Sprinter r. v. 2018 →		
4800-15	079025	92,60
Adaptér chladiče (s bajonetovým uzávěrem) pro • osobní vozidla: – MINI r. v. 2001 → – MERCEDES-BENZ SLK · CLK · Sprinter r. v. 1999 → typ 170 · 208 · 611 a také W124 r. v. 1984 → 1993		
• Užitkové vozy / zemědělské stroje: – DEUTZ Motory KHD1015 · D2008 · D2009 · TD2,9 L4 · TCD3,6 · BFM1013 · BFM2012 · TCD2013 2V · BFM1015 · TCD2015 V8 · V6 · M · TCD 12,0 a 16,0		
4800-16	098507	39,30
Adaptér chladiče pro • OPEL Vectra C · Astra H · Astra J · Astra K · Meriva · Signum · Corsa D · Insignia		
• JOHN DEERE – Traktory řada 5 · řada 6 · řada 7 · řada 8 · řada 9 – Polní sekačka řada 8000 · řada 9000 – Samopojízdný polní postřikovač R4040 · R4050 · R4140 · 4150 – Rádkovač W170 – Stroj na sklizení bavlny CP690 – Bager 160DLC – Buldozer 700J – Kolový nakladač WL53 · WL56		
• HITACHI bagr ZAXIS 6 • HAGIE STS 10 · 12 · 14 · 16		
4800-17	109661	73,70

4800 Adaptér pro chladiče

HAZET No.	EAN-No. 4000896+	€
Adaptér chladiče pro • MERCEDES-BENZ Sprinter r. v. 2006 → · Viano r. v. 2003 →		
4800-18	128815	82,10
Adaptér chladiče pro • VW Crafter · MAN TGE		
4800-19	128822	93,20
Adaptér chladiče pro • MAZDA 3 Volvo C30 · S40 r. v. 2004 → · V50 Volvo užitk. voz. Dumper s kloubovým řízením FORD Focus r. v. 2008 → · Fiesta r. v. 2008 → · C-Max · Galaxy r. v. 2006 → · Kuga a S-Max		
4800-21 A	162185	104,50
Adaptér chladiče (s bajonetovým uzávěrem) pro • CITROËN C1 • DAIHATSU Cuore L201 · L501 · Move L601 • MAZDA 121 · Demio • MITSUBISHI Grandis r. v. 2004 → · L400 · Pajero Pinin / Sport · Space-Gear · -Runner · -Wagon • PEUGEOT 107 r. v. 2006 → • ROVER 600 • SUBARU B9 Tribeca · Justy • SUZUKI Alto • TOYOTA Aygo r. v. 2006 → · Celica · Corolla · Rav 4 · Starlet · Yaris		
4800-22	144266	64,95
Adaptér chladiče (s bajonetovým uzávěrem) pro • DAIHATSU Standard • HONDA Accord · Civic · Legend • HYUNDAI · ISUZU nákl. voz. · KIA • MAZDA 323 · 626 r. v. 2002 · 6 · MX5 · Premacy r. v. 2000 → · RX8 • MITSUBISHI Carisma · Eclipse · Galant · Lancer · Outlander · Pajero · Sigma · Spacewagon D r. v. 2003 → • MITSUBISHI užitk. voz. Fuso Canter • NISSAN 350Z · Almera · Maxima · Micra r. v. 2004 → · Terrano 2 · X-Trail · vidlicový vozík • TOYOTA Avensis · Carina E • SUZUKI Baleno · Wagon-R • SUBARU Forester · Impreza · Legacy · Outback • OPEL Agila 1,0 a 1,2 l a • SMART Forfour • YALE GDP/ GLP 16-30		
4800-23	144273	70,40
Adaptér chladiče pro • Pro BMW : řada 1 (E87/F20) · řada 2 (F22) · řada 3 (F30) · řada 3 GT (F34) · řada 4 (F32/F33) · řada 5 r. v. 6/2003 → (E60/F12) · řada 5 GT (F07) · řada 6 r. v. 2004 → (E63/F12) · řada 7 (E65/F01) · X1 (E84) · X3 r. v. 2010 → (F25) · X4 r. v. 2013 → (F26) · X5 r. v. 2013 → (F15) · X6 (E71) · Z4 r. v. 2013 → (E89)		
4800-24	203864	72,70

4800 Univerzální adaptér

Made in Germany

- Použití: Kontrola netěsnosti v chladicích systémech a topných okruzích

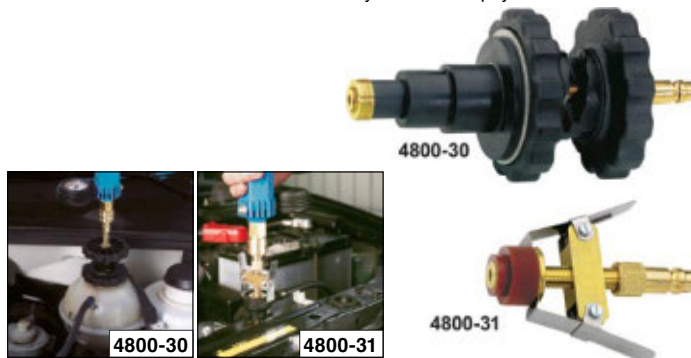

HAZET No.	EAN-No. 4000896+	€
• Pro otvory chladiče o \varnothing 20–41 mm • 3stupňové hrubé nastavení plus jemné nastavení		
4800-30	078202	152,40



Speciální nářadí

Motor – Diagnostika



4800 Univerzální adaptér

HAZET No.	EAN-No. 4000896+	€
4800-31	078196	98,40

- Speciálně pro japonské automobily \varnothing 18–24 mm
- Všechny aktuální modely **MAZDA**
- Upevnění upínacími svorkami

4795 Tester ztráty tlaku ve válci

Made in Germany

• Jednoduché použití, okamžitý výsledek zkoušky

• Použití: Diagnostika závad motoru např. na sacích a výfukových ventilech, pístech / pístních krouzcích a hlavě válců / těsnění hlavy válců



HAZET No.	EAN-No. 4000896+	€
4795-1	083770	214,20
• Adaptér pro motocykly		
• Závít M 12 x 1,25 (vnější závít)		
4795-11	083787	21,-
• Adaptér pro motocykly a dieselové motory		
• Závít M 10 x 1 (vnější závít)		
4795-12	083794	22,-
• Adaptér pro dieselové motory		
• Závít M 24 x 2 (vnější závít)		
4795-13	083800	32,60
• Adaptér pro VW dieselové motory včetně 4795-11		
• Čep \varnothing 7 mm		
4795-14	083817	58,35
• Adaptér pro víceventilové motory		
závít M 14 x 1,25		
• Délka 165 mm		
4795-15	104345	35,30
• Adaptér pro víceventilové motory		
• Závít zapalovacích svíček M12 x 1,25 (14 mm zapalovací svíčky)		
4795-16	215140	37,30

4810 C Optický refraktometr

Made in Germany

• (Refraktometr) – také pro G12++, G13, G48, G64, AdBlue

• Použití: Měření obsahu na ochranu proti mrazu v chladicí vodě, vhodné také pro chladicí kapaliny G11, G12++, G12 EVO, G13, GG40, G48 a G64

• Překontrolování kvality provozního prostředku AdBlue, kontrola hustoty kyseliny baterie (stav nabití baterie)

• Optický tester (refraktometr) s integrovaným osvětlením (LED) v záklopc

• Včetně odběrové pipety a návodu k použití

Popis stupnice:

A – stav nabití

B – obsah AdBlue

C – obsah nemrzoucí směsi

D – obsah nemrzoucí směsi do ostřikovačů

5 – světlá/tmavá linie pro odečítání stupnice



4810 C Optický refraktometr

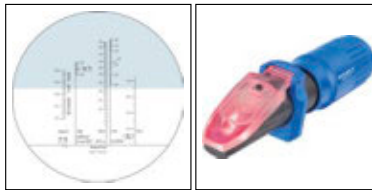

HAZET No.	EAN-No. 4000896+	€
4810 C	186402	148,20

4800 Zkoušečka těsnosti hlavy válců

Made in Germany

• Pro adaptér chladiče HAZET 4800

• Použití: Bezpečné rozeznání poškození hlav válců, netěsností mezi spalovacím prostorem a chladicím systémem u vodou chlazených spalovacích motorů **plyn, nafta, benzin**

• Vč. reakční kapaliny



HAZET No.	EAN-No. 4000896+	€
4800-41	058891	136,60
• Reakční kapalina (250 ml)		
Pro tester netěsnosti hlavy válců HAZET 4800-41		
4800-041	108985	64,35

4793 Zkoušečka těsnosti hlavy válců

Made in Germany

• Použití: Rozeznání poškození těsnění hlavy válce, netěsností mezi spalovací komorou a chladicím systémem

• Pro vodou chlazené spalovací motory (plyn, nafta a benzin)

• Kovová schránka (modrá HAZET)

• 2komponentní měkká pěnová vložka



HAZET No.	$d \times š \times v$ mm	□	EAN-No. 4000896+	€
4793/3	320x128x58	3	076192	239,10
• Tester				
4793-1	–	–	076185	164,40
• Reakční kapalina (250 ml)				
4793-2	–	–	076208	24,10
• Vyplachovací kapalina (250 ml) pro čištění testeru 4793-1				
4793-3	–	–	076215	15,75



Výfukový systém / lambda sonda

4684 Výfukové systémy

- Hák 40 mm, 9° zahnutí
- Použití: **Montáž a demontáž přídržovacích gumiček na výfukových systémech**, např. pro vozidla **FORD** Fiesta, Orion, Escort, **BMW** atd.
- T-rukojeť z plastu
- Povrch: chromováno



HAZET No.	l mm	EAN-No. 4000896+	€
4684-1	209	022199	19,-

Made in Germany

- Hák 17 mm, půlkruhový, v úhlu 20°
- Použití: **Montáž a demontáž přídržných gumových vložek u výfukových systémů** např. pro **VW · AUDI · MERCEDES-BENZ · OPEL**, japonská vozidla atd.
- T-rukojeť z plastu
- Povrch: chromováno



HAZET No.	l mm	EAN-No. 4000896+	€
4684-2	209	022205	19,-

4682 Řetězový řezák trubek

- **Jednoduché nastavení pomocí křídlového šroubu během řezání**
- Použití: **Oddělování např. výfukových trubek** zejména z oceli **V2A** do tloušťky stěny 2,5 mm a Ø 75 mm
- Větších průměrů řezání lze dosáhnout prodloužením pomocí řetězu 4682-01
- Malé vynaložení síly, zafixováno **technikou uchopení**
- Povrch: niklováno



HAZET No.	l mm	Ø mm	EAN-No. 4000896+	€
4682	255	15-75	022168	159,40
• Náhradní řetěz pro 4682				
4682-01	-	-	022175	78,75
• Sada náhradních dílů · 9-dílná pro opravu řezného řetězu 4682-01 Pro 4682				
4682-01/9	-	-	057214	14,95

4682 Řetězový řezák trubek

- **Jednoduché nastavení pomocí křídlového šroubu během řezání**
- Použití: **Oddělení trubek** z pozinkované nebo nerezové (V2A) oceli, mědi, PVC a hliníku až do tloušťky stěny 6 mm a Ø 115 mm
- 15 řezacích koleček z legované oceli
- Povrch: niklováno



HAZET No.	l mm	Ø mm	EAN-No. 4000896+	€
4682-1	315	20-115	149384	168,30
• Náhradní řetěz pro 4682-1				
4682-03	-	-	149421	116,90

850 LG-GE Nástrčná hlavice TORX®

- **Made in Germany**
- Použití: Manipulace se šroubením olejových van u motoru a automatických převodovek. Vymontování chladiče AGR, ventilu AGR, víka ventilu atd. u **MERCEDES-BENZ** m. j. u motoru OM 651 Demontáž držáku převodovky odpadá, úspora času: cca 20 minut Podstatně lepší dosažitelnost šroubení u ventilu a chladiče AGR umožňuje další úsporu času cca 15 minut
- Nástrčná hlavice a prodloužení jsou pevně spojeny
- S kloubem – pro použití na těžko přístupných místech a pro obejití rušivých hran
- Povrch: chromováno, leštěno
- DIN 3124, ISO 2725-1

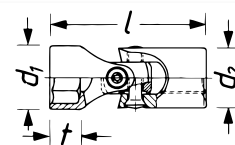

HAZET No.	l mm	d ₁ mm	d ₂ mm	mm	EAN-No. 4000896+	€
850 Lg-GE 10	150	12	13,5	9,42	223572	35,50





Speciální nářadí

Převodovka



4680 Nástavec pro lambda sondy

Made in Germany

- Pro lambda sondy u vozidel **NISSAN · FORD · VOLKSWAGEN · SEAT · ŠKODA** atd.
- Optimální přenos síly na 6hran. profil lambda sondy
- Dlouhé provedení
- Povrch: chromováno
- DIN 3124, ISO 2725-1



HAZET No.	S mm	l mm	d ₁ mm	d ₂ mm	EAN-No. 4000896+	€
4680-1	22	92	30,4	25	165605	37,30

Made in Germany

- Použití: Pro lambda sondy (s 22 mm) na **MERCEDES-BENZ**
- Dlouhé provedení
- Povrch: chromováno
- DIN 3124, ISO 2725-1



HAZET No.	S mm	l mm	d ₁ mm	d ₂ mm	EAN-No. 4000896+	€
4680-2	22	110	36	30	022090	63,-

Made in Germany

- Volitelně □ pohon 12,5 = 1/2" nebo ● 32 mm



- Použití: Pro lambda sondy (s22 mm) na **VW, AUDI**
- Dlouhé provedení
- Povrch: chromováno
- DIN 3124, ISO 2725-1



HAZET No.	S mm	l mm	d ₁ mm	d ₂ mm	EAN-No. 4000896+	€
4680-3	22	110	41	34,4	022106	70,35

Made in Germany

- Použití: Montáž a demontáž lambda sondy (s 22 mm)
- Např. u **FORD · BMW · OPEL · VW · AUDI · SEAT** a **ŠKODA**
- Dvojitý □ pohon 12,5 = 1/2" nebo manipulace pomocí 6hranu s 30 mm
- Samoobslužné balení
- Povrch: fosfátováno, olejováno
- DIN 3124, ISO 2725-1



YouTube Clip

HAZET No.	S mm	EAN-No. 4000896+	€
4680-5	22	057870	91,50

Jednotlivé a náhradní díly od strany 482 po stranu 490

Převodovka

2174 Přípravek pro vystředění spojky

- Vystředění spojkového kotouče přes pilotní ložisko odpadá



- Použití: Přesná fixace a ustavení spojkového kotouče k přitlačné desce spojky
- Snadná a rychlá montáž
- Také pro vozidla bez vodicího ložiska
- Pro osobní vozidla a lehká užitková vozidla
- Se 2 upínacími kužely: velikost 1 = 15–21 mm Ø velikost 2 = 21–28 mm Ø
- Plast s kovovým upínacím šroubem



HAZET No.	EAN-No. 4000896+	€
2174	013609	90,65

880 GZ Kloubová nástrčná hlavice · dvojitý šestihran

Made in Germany



- Použití: Ovládání šroubení převodovky (šrouby s dvojitým 6hr.) na vozidlech **AUDI** r. v. 2008 → např. A4, A5, A6, A7, A8, Q5, Q7
- S kloubem – pro použití na těžko přístupných místech a pro obejítí rušivých hran
- S kuličkovou pojistkou
- Povrch: chromováno, leštěno
- DIN 3124, ISO 2725-1

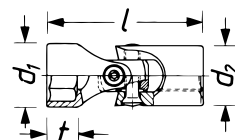

YouTube Clip

HAZET No.	l mm	d ₁ mm	d ₂ mm	t mm	EAN-No. 4000896+	€
880 G-Z 16	45,8	22	19	10	203734	37,05
880 G-Z 18	46,8	24,5	19	11	203529	37,05

2756 Nástrčná hlavice

Made in Germany



- Délka čepce hlavice šroubováku **TORX** je přesně přizpůsobená prostorovým podmínkám, což umožňuje přímý přístup ke šroubení a hlavice není opřená o přírubu kloubové hřídele

- Použití: K ovládání šroubení kloubové hřídele na převodovce **MERCEDES-BENZ** GLC (X253) od r. v. 2015, GLC Coupé (C253) od r. v. 2016 s 4Matic
- S kuličkovou pojistkou
- Povrch:
- DIN 3124, ISO 2725-1

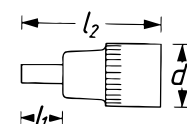

HAZET No.	l ₁ mm	l ₂ mm	d mm	t mm	EAN-No. 4000896+	€
2756-T 60	65	103	24,6	13,25	204243	25,85

Nezávazně doporučená ceníková cena bez DPH – Platí do 31.12.2021



Olejevý servis

Přehled klíčů na olejové filtry

HAZET No.	Provedení hrany/drážky	Olejevý filtr Ø mm	Klíč na olejové filtry Ø mm	Hloubka upnutí klíče mm	Celková výška v mm	Nástrčný otvor		Strana
						Ø mm	□	
2168-46	6hr.	46	59	15	29,5	–	7	469
2169	14hr.	74,4	82	30	52	27	7	410
2169-1	15hr.	92	102	19	48	27	8	410
2169-5	18hr.	135	148	41	57	24	8	470
2169-6	16hr.	86,7	97	44,5	55,5	24	8	411
2169-7	14hr.	64	76	23	43	24	8	411
2169-8 A	15hr.	74	90	–	38	–	8	412
2169-9	15hr.	105	119	36	52	24	8	470
2169-10	14hr.	74,4	82	20	42	27	7	410
2169-11	14hr.	84	97	30,5	48,5	24	8	411
2169-32	6hr.	32	43	18	30	–	7	411
2169-36	6hr.	36	49,5	15,2	29,5	–	7	411
2169-66	6 drážek	66	76	23,5	43,5	24	8	411
2169-76	6 drážek	76	85	21	42	24	8	411
2169-76 B	6 drážek	76	85	21	42	24	8	412
2169-76 K	6 drážek	76	85	14,5	34	24	8	411
2169-86	9 drážek	86	97	24,5	44	24	8	411



Použití výrobku

Olejevý servis
hazet.de → Servis → Poradce pro použití
 → Olejový servis
 ◀ Pro smartphony s aplikací QR Reader

2169 Klíč na olejové filtry

Made in Germany

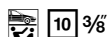

- Použití: Manipulace s olejovými filtry a víky krytu olejového filtru
- 14hran s 74,4 mm
- □ Pohon 10 = 3/8", resp. vnější šestihran 27 mm

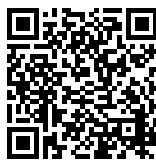
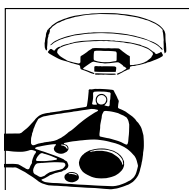

360°



2169 Klíč na olejové filtry

Made in Germany

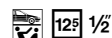

- Volitelně □ pohon 12,5 = 1/2", resp. vnější šestihran 27 mm

- Použití: Manipulace s olejovými filtry (filtry KNECHT a MAHLE) 15hran s 92 mm
- Např. pro VW · AUDI Passat 1,9 TDi · 2,8 I · CHRYSLER 300 M · PORSCHE · OPEL · RENAULT · FORD Focus 1,8 Di od 08/1999 · 1,8 TDi od 10/1998 · Maverick 2,7 TD · Mondeo 2,5 I · MITSUBISHI · NISSAN · ALFA-ROMEO · HONDA · Volvo atd. MAN (UV) F 2000

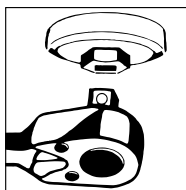

HAZET No.	mm	Ø mm	EAN-No. 4000896+	€
2169-1	27	102	013357	23,90

Made in Germany



- Kované provedení

- Použití: Montáž a demontáž olejových filtrů a vík tělesa olejového filtru při výměně olejové vložky
- Povrch: chromováno



HAZET No.	mm	Ø mm	EAN-No. 4000896+	€
2169	27	82	013340	18,85
2169-10	27	82	108831	18,70

• Pro filtry MANN a KNECHT · OPEL filtry LongLife např. pro OA MERCEDES-BENZ s motorem 2,2 l CDI · M 102 · M 103 · M 104 · M 110 · M 111 · M 119 · M 120 · M 613 · Sprinter 2,2 l Turbo r. v. 2006 → · dieselový motor OM 651
 AUDI A4 2,0 r. v. 2002 → · A4 4-válc. benzínový r. v. 12/2007 →
 BMW OA · BMW motocykl · Modely K = K 75-1100 LT · Model řada F a K
 VW Passat 1,9 TDI čerpadlo tryska · Passat B7 1,4 · 1,8 · 2,0 l TSI · Golf Plus 2,0 r. v. 2005 → · Golf 6 1,6 l a 1,2 / 1,4 / 1,8 / 2,0 l TSI · Golf 7 1,2 - 1,4 l TFSI · Polo 5 1,2 l - 1,4 l TSI · Tiguan r. v. 2007 → 1,4 l TSI (110 kW) 2,0 l TSI a také FORD · OPEL · PORSCHE · PEUGEOT · CITROËN · RENAULT · NISSAN · TOYOTA · MAZDA atd.

• Manipulace s víkem skříně olejového filtru při výměně vložky olejového filtru u vozidla MAZDA 3 s motorem 2,0 l a 6 s motorem 1,8 - 2,0 - 2,3 l

• Nízká konstrukční výška: 14hran natočený až k profilu



Speciální nářadí

Olejevý servis



2169 Klíč na olejové filtry

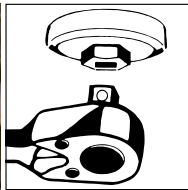

YouTube Clip

HAZET No.	mm	Ø mm	EAN-No. 4000896+	€
-----------	----	------	------------------	---

• **Šestihran s 32 mm**
OPEL Astra · Corsa · 1,9 l CDTi · Astra 2,0 CDTi
VW Passat · Golf 6 s 1,6 a 2,0 CR-TDi · Passat B7 1,6 · 2,0 diesel · Golf 7 2,0 benzínový · Polo 5 1,2 l-1,4 l TDi · Polo 1,2 l benzínový r. v. 2005 → · Transporter T5 1,9 l diesel r. v. 2004 → · Touran TDi · Tiguan r. v. 2007 → 1,4 l (90/118 kW) 2,0 l dieselové motory · **AUDI** A6 3,2 l TSI · V6 r. v. 2004 → · A4 diesel r. v. 12/2007 →
BMW 530d M57 r. v. 2008 →
 Pro močovinné filtry Ad-Blue® **MAN** např. TGX

2169-32	32	43	082346	24,60
---------	----	----	--------	-------

• **Šestihran s 36 mm**
 např. pro **MERCEDES-BENZ** motor 116 MB · 100 D Transporter · Actros MP 1 · MP 2 · **BMW** M 52 6-válc.: řada 3 · řada 5 · M 60-8-válc.: řada 5 · řada 7 · řada 8 · M 73-12-válc.: řada 7 · řada 8 · řada 1 (E87): 118d · 120d · řada 1 (F20) 118i · **OPEL** Vectra B DI 16 V · Insignia · **VW** Lupo 1,2 TDi · Polo 5 1,2 l · Golf 6 1,4 l SRE/TSI · Touareg TDi · T5 2,5 D · Passat B7 3,6 l FSI · **AUDI** 6-válc. benzínový od 12/2007
 Pro palivový filtr **MAN** např. TGA

2169-36	36	50	086566	26,20
---------	----	----	--------	-------

• **Made in Germany**

- Použití: Manipulace s olejovými filtry a tělesy olejových plastových filtrů
- □ Pohon 12,5 = 1/2", resp. vnější šestihran 24 mm



HAZET No.	mm	Ø mm	EAN-No. 4000896+	€
-----------	----	------	------------------	---

• **16hran s 86 mm**
 Např. pro **BMW** 316i Limousine Touring · 316ti Compact · 318Ci Cabrio · Coupé · 318i Limousine Touring · Compact r.v. 2001 → · řada 1 (E87): 116i · 118i · 120i · 130i
 • **Volvo** V40 · V70 · S40 · S60 · S70 · S80

2169-6	24	97	100293	24,30
--------	----	----	--------	-------

• Manipulace s **olejovými filtry**
14hran s 64 mm u
TOYOTA Yaris · Corolla · MR2 r. v. → 1999 · Starlet · Celica · Avensis
NISSAN Micra · Almera
MAZDA 323 · 626 · MX-5 · Xedo
MERCEDES-BENZ třída A (typ 177), třída B (typ 247) s OM 608 motor
SMART ForFour (typ 454) motor 134 · 135 · SMART Fortwo (typ 451) motor 132 · a také
SUBARU · **SUZUKI** · **DAIHATSU**
 Vhodné i pro **YAMAHA** Super Ténéré XT1200 z · YZF-R1 r. v. 2007 → · YZF-R6 r. v. 2006 → · FZ1-S r. v. 2006 → · FZ1-N r. v. 2006 → · FZ6-S r. v. 2007 → · FZ6-N r. v. 2007 →
BMW G310R a G310GS

2169-7	24	77	100224	31,-
--------	----	----	--------	------

• **14hran s 84 mm**
 Manipulace s **tělesem olejového filtru** z plastu např. u **MERCEDES-BENZ** V6 diesel motorů OM642 apod. pro 164 · 203 · 204 · X204 · 210 · 212 · 639
 • Pro manipulaci s víkem tělesa palivového filtru u **MERCEDES-BENZ** typ 213 s OM 654

2169-11	24	97	118847	33,90
---------	----	----	--------	-------

2169 Klíč na olejové filtry

• **Made in Germany**

- Použití: Manipulace s olejovým filtrem Purflux
- □ 12,5 = 1/2", resp. vnější šestihran 24 mm

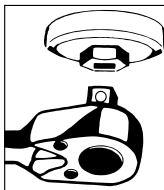

HAZET No.	mm	Ø mm	EAN-No. 4000896+	€
-----------	----	------	------------------	---

• s **66mm drážkový profil (6 drážek)**
 • **RENAULT** Clio · Twingo (také manipulace s víkem tělesa olejového filtru) · Kangoo,
FIAT Punto · Stilo · Brava · Bravo s 1,2 l,
LANCIA Y 1,2 l,
MAZDA 323 · 626 · MX 3 · Xedos,
MITSUBISHI Colt · Carisma · Space Star,
NISSAN Micra · Primera · Serena,
TOYOTA Yaris · Starlet · MR 2 · Corolla · Carina · Avensis

2169-66	24	76	100217	23,-
---------	----	----	--------	------

• s **76mm drážkový profil (6 drážek)**
 • Např. pro **AUDI** A3 · A4 · A6 · **CITROËN** C5 · Xantia · **DACIA** · **FIAT** Brava · Bravo · Punto · Tipo · **FORD** Fiesta · Escort · **MERCEDES-BENZ** OA a Sprinter · např. Citan 1,5 l Diesel · **PEUGEOT** 106 · 206 · 306 · 406 · **RENAULT** Clio · Kangoo · Mégane · Laguna · Rapid · **HONDA** Accord · Civic · Prelude · CRX · **OPEL** Astra G/F · Corsa A/B · Calibra · Zafira · Frontera · **SUZUKI** Grand Vitara 1,9D r. v. 2009 **VW** Golf 3 a 4 · Polo · Passat · Sharan · **SEAT** Alhambra · Toledo · León · Córdoba · **ŠKODA** Octavia
 pro **palivový filtr**
 např. pro **RENAULT** Espace · Laguna · R19 · **Volvo** S 40 a V 40 r. v. → 1999

2169-76	24	85	100309	23,70
---------	----	----	--------	-------

Obzvlášť pro BMW motocykly
 • s **76 mm drážkový profil (6 drážek) s nízkou výškou**
 • Pro **BMW** motocykly, nové modelové řady R1200 GS · R1200 R · R1200 RT · R1200 ST · r.v. 2004 → 2012
 • **SMART** 453

2169-76 K	24	85	158188	26,05
-----------	----	----	--------	-------

• s **86mm drážkový profil (9 drážek)**
 • Např. pro **ALFA** 145 · 146 · 156 1,9 JTD · 156 2,4 JTD · **VW** Golf 3 · Sharan · Vento · Passat s TDi motorem · Lupo · Polo 1,7 SDi · **AUDI** A4 · A6 s TDi motorem 85 KW/115 PS · **FIAT** Bravo a Brava 1,9 JTD · **RENAULT** Clio · R 19 s 1,4 – 1,7 a 1,8 l · Mégane 1,4 a 2,0 l · Rapid s 1,9 D · Laguna · Safrane a Espace 3 s 2,1 D · **SEAT** Alhambra · 1,9 TDi · Arosa 1,7 SDi · **SUZUKI** Grand Vitara 1,9 DDIS
 pro **palivový filtr**
 např. **MERCEDES-BENZ** Vito · Sprinter · třída A (typ 168) · třída C (typ 202) · třída E (typ 210)

2169-86	24	97	100323	23,40
---------	----	----	--------	-------





2169 Klíč na olejové filtry

Made in Germany

- Použití: Manipulace s olejovým filtry Purflux
- □ 12,5 = 1/2", resp. vnější šestihran ø 24 mm
- s 76mm drážkový profil (6 drážek)
- Bezpečný, nevodivý ochranný nátěr proti nebezpečí zkratu: U některých **RENAULT**, např. motor K9K se olejový filtr nachází velmi blízko v oblasti alternátoru příp. startéru
- Nápadná nanesená barva snižuje nebezpečí možného zapomenutí klíče v prostoru motoru po použití
- Pro např. **AUDI · CITROËN · DACIA · FIAT · FORD · MERCEDES-BENZ · NISSAN · PEUGEOT · RENAULT · HONDA · OPEL · SUZUKI · VW · SEAT · ŠKODA**

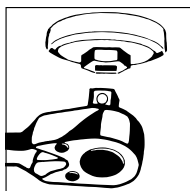

HAZET No.	Ø mm	EAN-No. 4000896+	€
2169-76 B	85,6	230259	25,70

Made in Germany

- Použití: Manipulace s olejovými filtry a tělesy olejových filtrů
- □ Pohon 12,5 = 1/2"
- 15hran s 74 mm
- Ovládání u olejových filtrů u modelů **FORD** např. motory EcoBoost apod. B-Max · C-Max 2 · Fiesta 5-6-7 · Focus 2-3 · Fusion · Galaxy · Mondeo 4-5 · Tourneo · Transit, Ka+ · Kuga 2 · S-Max
- **MAZDA** 2 (DL, DJ) 1,5D · 3 (BK, BL) 2,0 (BM, BN) 1,5D · 2,2D (BP) 1,8D · 5 (CW) 1,8-2,0 · 6 (GG) 1,8-2,0 (GY, GH) 1,8-2,0-2,5 (GJ, GL) 2,2D · CX-3 (DK) 1,5D-1,8D · CX-5 (KE, GH, KF) 2,2D · CX-7 (ER) 2,3D-2,5D · MX-5 (NC) 1,8-2,0



HAZET No.	mm	Ø mm	EAN-No. 4000896+	€
2169-8 A	24	105	232956	19,30

2169 Sada klíčů na olejové filtry

Made in Germany

- Manipulace s olejovými filtry a tělesy olejových plastových filtrů
- Rychlá obsluha, jistá, čistá a odborná práce
- Utahovacího momentu doporučeného výrobcem vozidla lze bezpečně dosáhnout např. pomocí momentových klíčů HAZET 6110-1 CT (10 = 3/8") a HAZET 6121-1 CT (12,5 = 1/2")
- **Pozor:** Dodržte hodnoty utahovacího momentu stanovené výrobcem vozidla
- Sada klíčů na olejové filtry, obsah: 2169 · 2169-1 · 2169-6 2169-36 · 2169-76 · 2169-86



HAZET No.	□	EAN-No. 4000896+	€
2169/6	6	120628	118,70

2170 Univerzální pásový klíč

Made in Germany

- Zejména pro olejové filtry, generátor a jiná kulatá šroubení
- Tkaninová páska z bavlny, potažená pryží, výška 19,6 mm
- Neklouzavé
- Povrch: chromováno



HAZET No.	Ø mm	EAN-No. 4000896+	€
2170	80-180	013371	51,80

2171 Klíč na olejové filtry

- Nastavitelné otočným knoflíkem nebo 6hranem 13 mm

- Použití: Manipulace s olejovými filtry i ve stísněných prostorech
- Ocelový pás (12x1 mm), vyměnitelný



HAZET No.	Ø mm	EAN-No. 4000896+	€
2171-5	65-105	013449	47,95
2171-6	105-145	013456	55,60

2171 Řetěz na olejový filtr

Made in Germany

- Ovládání i ve stísněných prostorách

- Použití: Manipulace s olejovými filtry a ostatními kartušemi na osobních automobilech a užitkových vozidlech
- S upínacím řetězem



YouTube Clip

HAZET No.	Ø mm	EAN-No. 4000896+	€
2171-8	50-150	013463	79,25

2172 Klíč na olejové filtry

Made in Germany

- Pro těžko přístupné filtry
- Levotočivé a pravotočivé působení
- Univerzální použití
- □ Pohon 10 = 3/8" resp. ● 19 mm
- Kované provedení
- Povrch: zinkováno





Speciální nářadí

Olejevý servis



2172 Klíč na olejové filtry



10 3/8

HAZET No.	Ø mm	EAN-No. 4000896+	€
2172	65-115	013470	73,55

2527-5 Nástrčná hlavice s kulovou hlavou

Made in Germany

10 3/8

- Použití: Šrouby olejové vany (s 5 mm) u VW, AUDI, SEAT, ŠKODA
- DIN 3124, ISO 2725-1



HAZET No.	S mm	l1 mm	l2 mm	EAN-No. 4000896+	€
2527-5	5	200	227	016303	24,95

2528 Kloubové nástrčné klíče pro olejové vany

Made in Germany

10 3/8

- Použití: Šroubový spoj olejové vany (s 10 mm)
- S otočným kolíkem
- S kloubem – pro použití na těžko přístupných místech a pro obejítí rušivých hran
- Pohon s kuličkovou drážkou
- Povrch: chromováno
- DIN 3124, ISO 2725-1



HAZET No.	S mm	l mm	EAN-No. 4000896+	€
2528-10	10	250	016327	46,60

2567 Nástrčná hlavice pro olejový servis

Made in Germany

12 1/2

- Použití: Výměna oleje v převodovce (šroub XZN s vedením čepu)
- AUDI A2 · A3 · A4 · A6 · TT, VW Passat B5 · Golf 4 · LT · T4 · T5
- ŠKODA Fabia · Octavia · Superb
- PORSCHE Boxster manuální převodovka
- FORD Galaxy 1,9 TDi s 6rychlostní převodovkou
- S rýhováním
- Povrch: chromováno
- DIN 3124, ISO 2725-1



YouTube Clip

HAZET No.	l1 mm	l2 mm	EAN-No. 4000896+	€
2567-16	22	60	016419	33,45

2528 Speciální bit pro šroub pro vypouštění oleje VAG

Made in Germany

6,3 1/4

- Demontáž a montáž plastového šroubu pro vypouštění oleje se speciálním profilem u plastových olejových van

- AUDI SEAT ŠKODA VW r. v. 2013 → s benzinovými motory 1,2 · 1,4 · 1,8 · 2,0 I TFSI
- AUDI A1 · A3 · A4 · A5 · Q5
- VW Golf 7
- SEAT León · atd. s dieselovými motory 1,6 a 2,0 I



HAZET No.	l mm	EAN-No. 4000896+	€
2528-1	35	201372	19,45

2760 Klíč pro servis olejů

Made in Germany

12

- Pro plnicí šroub oleje převodovky M 8
- Povrch: chromováno



HAZET No.	S mm	l mm	EAN-No. 4000896+	€
2760	14x17	237	017638	40,70
2760-2	13x14	287	017652	47,55





3420 Speciální vložka pro plastový šroub vypouštění oleje na FORD

Made in Germany

- Přesně vyladěná na plastový vypouštěcí šroub oleje
- Zabránění poškození použitím např. nevhodných uvolňovacích nástrojů

• Použití: Manipulace s plastovým šroubem vypouštění oleje u **CITROËN · FORD · OPEL VAUXHALL · PEUGEOT · TOYOTA**

Pro např.

- **CITROËN** C4 · C5 · Spacetourer · Jumpy · DS4 · DS5 s motorem 2,0 Blue HDi r. v. 09/2013 →
- **FORD** Mondeo · S-Max · Kuga · Galaxy · Focus · C-Max s motorem 2,0 TDCi r. v. 09/2014 →
- **FORD** (USA) Edge s motorem 2,0 TDCi r. v. 08/2015 →
- **FORD** (Austrálie) Kuga · Escape · Mondeo s motorem 2,0 TDCi r. v. 09/2014 →
- **OPEL** Grandland X 2,0 D r. v. 11/2017 →
- **VAUXHALL** Grandland X 2,0 D r. v. 10/2017 →
- **PEUGEOT** 308 · 508 · 3008 · 5008 · Expert · Traveller s motorem 2,0 Blue HDi r. v. 11/2013 →
- **TOYOTA** Proace Verso · Bus · Skříň · Valník s motorem 2,0 D r. v. 02/2016 →

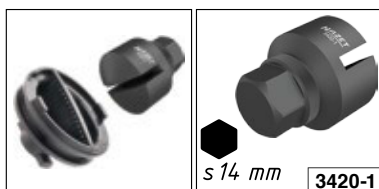

HAZET No.	l mm	EAN-No. 4000896+	€
3420-1	32	224159	7,10

3702 Nástrčná hlavice pro olejový servis

Made in Germany

- Pro plnicí a vypouštěcí šrouby převodovky, diferenciálu a olejové vany
- Povrch: chromováno
- DIN 3124, ISO 2725-1



HAZET No.	S mm	l mm	EAN-No. 4000896+	€
3702	8	36	018918	22,25
3702-1	10	36	018925	22,25

3703 Klíč pro servis oleju

Made in Germany

- Pro plnicí a vypouštěcí šrouby olejové vany, převodovky a diferenciálu na různých francouzských OA
- Vnější čtyřhran 8 a 10 mm
- Povrch: chromováno



HAZET No.	S mm	l mm	EAN-No. 4000896+	€
3703	8x10	233	018932	24,70

4618 Klíč pro servis oleju

Made in Germany

- Pro plnicí a vypouštěcí šrouby olejové vany, převodovky a diferenciálu např. u značky **FORD**
- S různými čtyřhrany 8,7 · 9,5 · 10,5 · 11,5 · 13 · 6,8 · 15,2 · 16,5 · 19,7
- Povrch: chromováno



HAZET No.	l mm	EAN-No. 4000896+	€
4618	218	021994	47,95

198-10 Plnicí trychtýř motorového oleje

Made in Germany

- Výměnný adaptér z hliníku

- Snadná montáž na motor vozidla
- Zaručuje u některých motorů potřebně pomalé, kontrolované plnění motorového oleje – časová úspora: během vytékání oleje lze provádět jiné práce
- Výměnné adaptéry z hliníku pro mnoho běžných modelů vozidel
- Flexibilní použití díky zásuvnému systému
- S volitelným úhlovým spojovacím kusem 198-12 vhodně i pro obtížně dostupné plnicí otvory oleje
- Speciální trychtýř z robustního plastu





Speciální nářadí

Olejevý servis / Servis brzd



198-10 Plnicí trychtýř motorového oleje

HAZET No.			EAN-No. 4000896+	€
Pro koncernová vozidla VW platformy MQB				
• Nutné při malém průměru nalévacího hrdla oleje				
• AUDI A3 (8V) · VW Golf 7 · SEAT León (5F) · ŠKODA Octavia 3				
• 2dílná sada, obsah, speciální trychtýř 198-9 · adaptér k plnění oleje 197-7				
• Made in Germany				
198-9/2	1	-	186396	103,90
• Bajonetový uzávěr, univerzálně použitelný např. na AUDI · VW · SEAT · ŠKODA · MERCEDES-BENZ atd.				
• 2dílná sada, obsah, speciální trychtýř 198-9 · adaptér k plnění oleje 197-10				
• Made in Germany				
198-10/2	1	2	187218	123,70
• Adaptér k plnění oleje pro plnicí trychtýř motorového oleje 198-9, použitelný u koncernových vozidel VW platformy MQB				
AUDI A3 (8V)				
VW Golf 7				
SEAT León (5F)				
ŠKODA Octavia 3				
• Made in Germany				
198-7	-	-	187256	42,35
• Speciální trychtýř z robustního plastu				
• Možná kombinace s adaptéry plnění oleje (198-7 · 10 · 13 · 14 · 15 · 16 · 17 · 18 · 19)				
a rovněž ve spojení s úhlovým spojovacím kusem 198-12 (adaptér a úhlový spojovací díl k dostání volitelně)				
• Made in Germany				
198-9	1	-	187249	81,20
• Adaptér s bajonetovým uzávěrem pro plnicí trychtýř motorového oleje 198-9, univerzálně použitelný mimo jiné u automobilů AUDI, VW, SEAT, ŠKODA, MERCEDES-BENZ, BMW atd.				
• Made in Germany				
198-10	-	-	187263	73,85
• Úhlový spojovací díl pro obtížně dostupné plnicí otvory oleje				
• Made in Germany				
198-12	-	-	206766	100,40
• Adaptér k plnění oleje pro plnicí trychtýř motorového oleje 198-9, použitelný u motorů:				
OPEL, RENAULT: G9Q-T-U				
NISSAN, OPEL, FIAT, RENAULT: R9M				
MERCEDES-BENZ: třída C typ 205, GLC typ 253 s OM 626, Vito typ 447 s OM 622				
DACIA: H5F · K7M · K4M · D4F · K7J · K4M · H4B · D4F				
• Made in Germany				
198-13	-	-	206773	66,60
• Adaptér k plnění oleje pro plnicí trychtýř motorového oleje 198-9, použitelný u MERCEDES-BENZ motoru				
M270: třída A typ 176 · třída B typ 246				
M271: třída C typ 203, 209, 204 · třída E typ 211, 212, 207 · SLK typ 171, 172 · Sprinter typ 906				
• Made in Germany				
198-16	-	-	206803	69,95
• Adaptér k plnění oleje pro plnicí trychtýř motorového oleje 198-9, použitelný u MERCEDES-BENZ motoru				
OM 654: třída A, typ 177 · třída B, typ 247 · třída C, typ 205 · třída E, typ 213 · třída V, typ 447				
M 282: třída A, typ 177 · třída B, typ 247				
• Made in Germany				
198-17	-	-	206827	51,40
• Adaptér k plnění oleje pro plnicí trychtýř motorového oleje 198-9, použitelný u MERCEDES-BENZ motoru				
OM 607: typ: 415 Citan, 176 třída A, 246 třída B, 117 CLA, X156 GLA · RENAULT motor K9K				
• Made in Germany				
198-18	-	-	219179	59,20
• Adaptér k plnění oleje pro plnicí trychtýř motorového oleje 198-9, použitelný u motorů 1,5 TSI koncernu				
AUDI A1 r. v. 11/2018 → A3 r. v. 05/2017 → Q2 r. v. 11/2018 → Q3 r. v. 09/2018 →				
SEAT Arona r. v. 11/2017 → Ibiza r. v. 08/2017 → León 3 r. v. 09/2018 → Tarraco r. v. 10/2018 → Ateca r. v. 10/2018 →				
ŠKODA Karoq 07/2017 → Octavia 3 r. v. 08/2017 → Suberb 3 r. v. 10/2018 →				
VW Arteon r. v. 11/2018 → Golf 7 r. v. 03/2017 → Golf Sportsvan 10/2017 → Polo 6 r. v. 09/2017 → T-Roc r. v. 11/2017 → Passat B8 r. v. 10/2018 → Touran 2 r. v. 10/2018 →				
• Made in Germany				
198-19	-	-	226993	36,25

Jednotlivé a náhradní díly od strany 482 po stranu 490

Servis brzd

163 Univerzální sada na brzdy

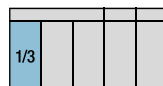

751 K HS-3	8801 K · O · $\frac{10}{32}$ 7	2784 · O · $\frac{10}{32}$ 7
751 K HS-4	986 · O · $\frac{10}{32}$ 9	2901 G · O · $\frac{10}{32}$ 7
748 LGB	986 LG · O · $\frac{10}{32}$ 9 · 11	4968-2
748 Lg b-3 · 748 Lg b-4		4968-6
810 U-PH · PH 3	2584-8 · O · $\frac{10}{32}$ 8	

HAZET No.	d x š mm		EAN-No. 4000896+	€
163-548/14	342x172	14	224197	204,50

2584-8 Nástrčná hlavice pro brzdové třmeny

- **Made in Germany**
- Použití: Manipulace se šrouby brzdových třmenů na zadní nápravě (s 8 mm) u AUDI TT od 2007, A4 od 2001, A6 od 2005, A8 od 2003
- Pro kontrolované utažení šroubů použijte momentový klíč s nástrčným otvorem 10 = $\frac{3}{8}$ ", např. HAZET 6110-1 CT
- S pevnou čepelí (s 8 mm) pro šrouby s vnitřním šestihranem
- DIN 3124, ISO 2725-1

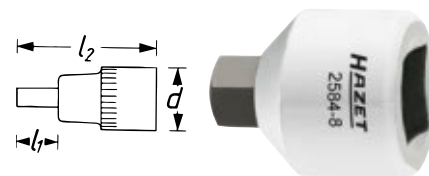

HAZET No.	S mm	l ₁ mm	l ₂ mm	EAN-No. 4000896+	€
2584-8	8	6,6	24	149438	14,60

2784 Nástrčná hlavice pro brzdové třmeny

- **Made in Germany**
- Použití: Manipulace s vodícím čepem s 7 mm na zadním brzdovém třmenu u MERCEDES-BENZ typ 204 (třída C)
- Pro kontrolované utažení šroubů použijte momentový klíč s nástrčným otvorem 10 = $\frac{3}{8}$ ", např. HAZET 6110-1 CT
- S pevnou čepelí (s 7 mm) pro šrouby s vnitřním šestihranem
- DIN 3124, ISO 2725-1

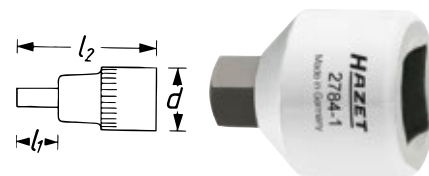

HAZET No.	S mm	l ₁ mm	l ₂ mm	EAN-No. 4000896+	€
2784-1	7	6,6	24	148530	14,60

Nezávazně doporučená ceníková cena bez DPH – Platí do 31.12.2021



2901 G Kloubový nástavec brzdového třmenu

Made in Germany

- Použití: Pro šroubení brzdového třmenu vzadu (s 7 mm) na **BMW** řada 3, 5 a 8 · **VW** Golf 7 r. v. 2013 → · **AUDI** A3 r. v. 2013 → · **ŠKODA** Octavia r. v. 2013 → a rovněž **OPEL**
- S kloubem – pro použití na těžko přístupných místech a pro obejití rušivých hran
- DIN 3124, ISO 2725-1



HAZET No.	S mm	l mm	EAN-No. 4000896+	€
2901 G-7	7	50	051816	27,05

Přířazovací tabulka pro klíč na odvzdušnění brzd HAZET č. 4968

	S mm				
BMW	7				
CITROËN		8	9		
DAIHATSU		8			
FIAT	7	8			
FORD	7	8	9	10	11
HONDA		8		10	
MAZDA		8			
MERCEDES-BENZ			9		11
MITSUBISHI				10	11
NISSAN				10	11
OPEL			9		
PEUGEOT	7	8	9	10	11
RENAULT	7	8	9		11

4968 Sada klíčů na odvzdušnění brzd

Made in Germany



HAZET No.		EAN-No. 4000896+	€
4968 • ●			
7 • 8 • 9 • 10 • 11			
4968/5	5	086535	94,10

4968 Klíč na odvzdušnění brzd

Made in Germany



- **Oboustranný šestihran, stejné velikosti klíče**

- Použití: **Odvzdušnění brzd bez demontáže kol** obnovení válců kolových brzd, hlavních brzdových válců a přípojek vedení
- Zahnuté a zakřivené
- Povrch: chromováno



HAZET No.	S mm	l mm	EAN-No. 4000896+	€
4968- 7	7	190	085705	19,50
4968- 8	8	208	085699	19,50
4968- 9	9	208	085682	19,50
4968-10	10	236	085712	19,50
4968-11	11	236	085729	19,50

4963 Brzdy

Made in Germany



- **V přední funkční části tlačný otočný díl s povrchem z tvrdokovu**

- Použití: Demontáž a montáž misky pružiny a přídržovací pružiny brzdového obložení u bubnových brzd
- Např. u **VW** · **SEAT** · **ŠKODA** · **OPEL** a **RENAULT** s bubnovou brzdou vzadu
- Plastová rukojeť
- Povrch: chromováno



HAZET No.	l mm	EAN-No. 4000896+	€
4963-1	237	050383	71,45

4964 Montážní nástroj na tažné pružiny

Made in Germany



- **Tažný hák s T-rukojetí**

- Použití: Demontáž a montáž **tažných pružin čelistí ruční brzdy** (kotoučová brzda vzadu)
- Např. u **MERCEDES-BENZ** OA a také Sprinter
- **VW** Crafter r.v. 2006 → 2016 a LT 1996 → 2006
- Povrch: chromováno



HAZET No.	l mm	EAN-No. 4000896+	€
4964-1	162	055708	18,80



Speciální nářadí

Servis brzd



2191 Sada dvojité lemovačky

Made in Germany

- Pro kovové trubky a vedení s tloušťkou stěny 0,7 až 1,0 mm
- Vedení 4,75–10 mm



• Použití: Vytváření otevřených (F) nebo dvojitých (E) lemů podle DIN 74234, normálních 90° a 180° lemů
Pro lemy na tažených a válcovaných trubkách

• Vyměnitelná upínací čelist se závěsy

Pozor: Pro plastem potažená brzdová potrubí použijte HAZET 2193/4 K

- Speciální litina
- Kovová schránka (modrá HAZET)
- 2komponentní měkká pěnová vložka

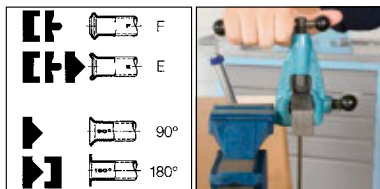

2181 N-1



2191



2191-1



2191-2



2191-3



2191

2191-4 • 2191-5
2191-6 • 2191-8
2191-9 • 2191-10



2191-90

HAZET No.	dxšxv mm		EAN-No. 4000896+	€
2191/12 K	290x173x50	12	013890	572,-

2191 Základní přístroj

Made in Germany

- Uchytení upínací čelisti 2191-1



HAZET No.	Ø mm	EAN-No. 4000896+	€
2191	4,75–10	013784	233,50

2191 Upínací čelist

Made in Germany

- Pro uchytení v základním přístroji 2191
- Pro lemy E, F, 90° a 180°
- 4,75 až 10 mm



HAZET No.	mm	EAN-No. 4000896+	€
2191-1	4,75–5–6–8–9–10 mm	013791	199,40

2191 Trubková fréza

Made in Germany

- Pro trubky s vnějším Ø 4-32 mm



• Použití: K odstranění ořezu z trubek



HAZET No.	Ø mm	EAN-No. 4000896+	€
2191-2	4–32	013814	29,95

2191 Podávací díl

Made in Germany

- Pro lemy E, F, 90° a 180°
- 4,75 až 10 mm



HAZET No.	Ø mm	EAN-No. 4000896+	€
2191-3	4,75–10	013821	14,40

2191 Tlačný díl

Made in Germany

- Pro lemy E a F
- Povrch: mořeno, olejováno

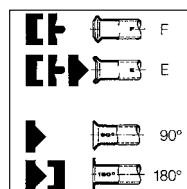

HAZET No.	Ø mm	EAN-No. 4000896+	€
2191- 4	4,75	013838	17,50
2191- 5	5	013845	17,50
2191- 6	6	013852	17,50
2191- 8	8	013869	17,50
2191- 9	9	013876	17,50
2191-10	10	013807	17,50

Made in Germany

- Pro lemy E a 90°, 180°
- 4,75 do 10 mm
- Povrch: mořeno, olejováno

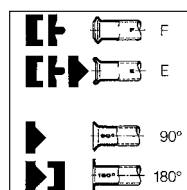

HAZET No.	Ø mm	mm	EAN-No. 4000896+	€
2191-90	4,75–10	($\frac{3}{16}''$ – $\frac{3}{8}''$)	013883	14,50



2193 Sada lemovačky trubek

Made in Germany

- Použití: Speciálně pro lemy F na brzdovém potrubí potaženém plastem Ø 4,75 mm
- Kovová schránka (modrá HAZET)
- 2komponentní měkká pěnová vložka



2181 N-1



2193-1



2193-2



2193 A

HAZET No.	d x š x v mm		EAN-No. 4000896+	€
2193/4 K	290 x 173 x 50	4	014088	526,-

2193 Lemovačka

Made in Germany

- Speciálně pro lemy F na brzdovém potrubí potaženém plastem Ø 4,75 mm

- Lehké a praktické
- Jak pro upnutí ve svěráku, tak pro ruční použití přímo pod vozidlem



HAZET No.	Ø mm	EAN-No. 4000896+	€
2193 A	4,75	142538	375,10

2193 Náhradní tlačný díl

Made in Germany

- Náhradní tlačný díl s upínacím kolíkem pro lemovací přístroj 2193 A



HAZET No.	EAN-No. 4000896+	€
2193/02	014071	42,70

2193 Ohýbací nářadí

Made in Germany

- Použití: Ohýbání brzdových trubek Ø 4,75 mm



HAZET No.	Ø mm	EAN-No. 4000896+	€
2193-1	4,75	014057	27,40

2193 Trubková fréza

Made in Germany

- Použití: Odhrotování trubek uvnitř a vně



HAZET No.	Ø mm	EAN-No. 4000896+	€
2193-2	4,75	014064	46,60

4968 Kartáč na brzdový třmen

Made in Germany

- Úzké provedení

- Použití: Odstranění tvrdého prachu z brzd, špíny na kotoučových brzdových třmenech
- Plastová rukojeť s otvorem pro zavěšení



HAZET No.	l mm	EAN-No. 4000896+	€
4968-2	225	084821	10,50

4968 Mosazný kartáč na brzdový třmen

Made in Germany

- Práce šetrná k materiálům díky měkkým mosazným štětinám

- Použití: Čištění hliníkových brzdových sedel
- Úzké provedení – pro úzké šachty brzdových sedel
- Plastová rukojeť s otvorem pro zavěšení



HAZET No.	l mm	EAN-No. 4000896+	€
4968-3	225	089147	15,-

4968 Pilník na brzdové třmeny

Made in Germany

- Jednostranné ozubení zabráňuje poškození prachové manžety na brzdovém pístu

- Použití: Odstranění tvrdého prachu z brzd, špíny a rzi na kotoučových brzdových třmenech
- šířka 12 mm
- Hrubost pilníku: hrubý, jednostranné šikmo ozubený
- Plochá škrabka na čelní straně k odstranění hrubých zbytků nečistot
- Plastová rukojeť



HAZET No.	l ₁ mm	l ₂ mm	EAN-No. 4000896+	€
4968-1	150	260	084739	39,50



Speciální nářadí

Servis brzd



4968 Pilník na brzdové třmeny

Made in Germany

• Extra úzký (šířka 10 mm), zejména vhodný pro japonská vozidla

- Použití: Odstranění tvrdého prachu z brzd, špíny a rzi na brzdových třmenech
- **Plochá škrabka** na čelní straně k odstranění hrubých zbytků nečistot

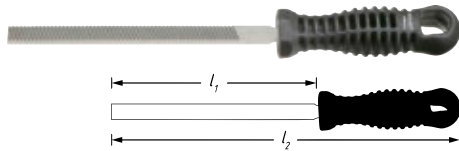

HAZET No.	l ₁ mm	l ₂ mm	EAN-No. 4000896+	€
4968-5	155	265	129379	39,55

Made in Germany

• Extra úzké provedení

- Použití: Odstranění tvrdého prachu z brzd, špíny a rzi u brzdových třmenů
- **Hrnatý pilník na brzdové třmeny**
- Velmi dobrá životnost
- 10 x 10 mm
- Plastová rukojeť s otvorem pro zavěšení

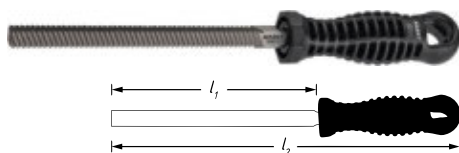

HAZET No.	l ₁ mm	l ₂ mm	EAN-No. 4000896+	€
4968-6	155	265	218431	39,55

4968 Škrabka na brzdová vedení

Made in Germany

• Zahnuté provedení umožňuje práci i u těžko dostupných míst

- Použití: K odstranění nečistoty, ochrany podvozku a rzi na brzdových vedeních a k vypátrání skrytých míst koroze
- Ke kontrole povahy brzdového vedení pro hlavní prohlídku (HU)
- Použití je možné tahem nebo sunutím
- Vyměnitelné břity
- Pro brzdová vedení Ø 4,75 mm
- 2komponentní rukojeť



HAZET No.	l mm	EAN-No. 4000896+	€
4968-12	245	219964	35,80
• Náhradní čepel pro škrabku na brzdová vedení 4968-12		229871	16,45
4968-012	-	229871	16,45

2582 Nastavovací páka brzd

Made in Germany

- Použití: Nastavení brzdových čelistí na **bubnové brzdy** s nastavením excentrem
- Nastavení ruční brzdy s nastavením excentrem
- Povrch: chromováno



HAZET No.	l mm	EAN-No. 4000896+	€
2582	304	017027	24,40

2730 Nástroj na přídržné pružiny čelistí ruční brzdy

Made in Germany

- Použití: Přídržné pružiny na čelistech ruční brzdy (kotoučové brzdy vzadu)
- Např. u **MERCEDES-BENZ** OA a také Sprinter **VW LT** r. v. 1996 → 2006 · Crafter r. v. 2006 → 2016
- T-rukojeť z plastu



HAZET No.	l mm	EAN-No. 4000896+	€
2730	142	017423	38,60

Made in Germany

• Nářadí přizpůsobené velmi zúženému prostoru

- Použití: Manipulace s přídržnými pružinami čelistí ruční brzdy (kotoučová brzda vzadu)
- **MERCEDES-BENZ** třída V (Vito / Vitano) typ 638 r.v. 1996 → 2003 · 639 r.v. 2003 → 2014 · 447 r.v. 2014 →
- Nářadí umožňuje bezproblémové dosažení přídržných pružin vzadu na straně náboje, protože není možná manipulace skrz otvor v náboji kol u výše uved. typů vozidel.
- T-rukojeť z plastu

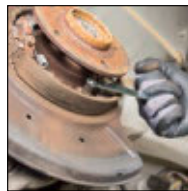

HAZET No.	l mm	EAN-No. 4000896+	€
2730-1	155	218400	27,95

4954 Tester brzdové kapaliny

- **Přenosné** (použitelné všude) – připojení k baterii nahrazuje stacionární stanici provozní napětí 12 V
- **Zkoušečka bodu varu** – vyšší přesnost měření oproti jiným zkušební metodám
- **Úspora času** – kapalina může u většiny vozidel zůstat v nádrži na kapalinu
- **Bezpečné a šetrné k životnímu prostředí**, protože nedochází ke ztrátě kapaliny
- Uznávaný výrobcí vozidel
- Splňuje také požadavky TÜV Rakousko
- Pro brzdovou kapalinu **DOT 3 · DOT 4 · DOT 4+ · DOT 5 · DOT 5+**
- **Jednoduché použití** – jedno ovládací tlačítko
- Není třeba žádný výběr brzdové kapaliny
- Varování při příliš nízkém provozním napětí
- Délka kabelu: 2,2 m
- **Test ve °C a °F** – rozsah teplot: 320° C / 608° F
- **Rychlá diagnostika** – doba měření: cca 30 sekund
- Testovací nádoba, stříkačka a návod k obsluze obsaženy v rozsahu dodávky
- Plastová skříňka



HAZET No.	EAN-No. 4000896+	€
4954-2	229628	210,70



4956 Posuvné měřidlo brzdových kotoučů

Made in Germany
• Vyduté měřicí plochy



- Použití: Zkontrolujte tloušťku brzdových kotoučů (stupeň opotřebení brzdového kotouče)
 - Dodržujte pokyny výrobce vozidla –
- Stavěcí šroub a dobíhavý nonius (Nonius $\frac{1}{10}$)
- V koženém pouzdru
- Pro OA a motocykly
- Měřicí rozsah 60 mm
- Délka měřících čelistí 75 mm



HAZET No.	EAN-No. 4000896+	€
4956-1	073160	144,-

4956 Posuvné měřidlo brzdových kotoučů / měřič tloušťky

• Měření je možné bez demontáže kol



- Snadné měření na vozidle v rámci přímé přejímky v přítomnosti zákazníka
- Rozsah měření: 0 – 60 mm (hodí se i pro použití na užitkových vozidlech)
- Jednoduchá manipulace
- **Upozorněn:** Informace k mezím opotřebení – respektujte údaje výrobce výrobců vozidel



HAZET No.	l mm	EAN-No. 4000896+	€
4956-3	395	219032	50,45



4956 Posuvné měřidlo brzdových kotoučů

- Použití: Snadné, rychlé zjištění průměru brzdových kotoučů skrz otvory ráfků bez předchozí demontáže kol
- Měřicí rozsah 200–400 mm
- Univerzálně použitelná

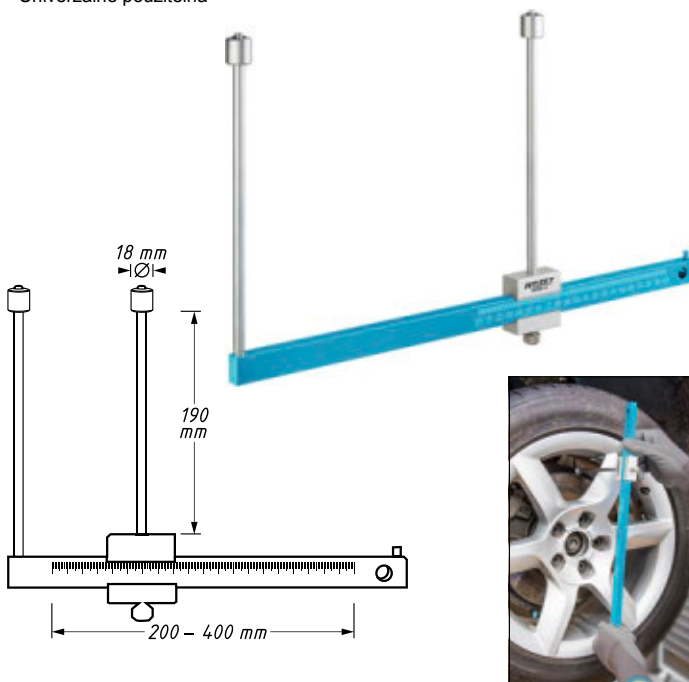

HAZET No.	EAN-No. 4000896+	€
4956-4	222339	85,95

4968 Sada nářadí pro kontrolu brzd

• Šroubový mikrometr pro přesné stanovení tloušťky brzdového kotouče



- Použití: Kontrola bočního házení brzdového kotouče
- Přesný indikátor pro ověření boční házivosti
- Rameno s kloubem a magnetickou nohou jako zavěšení resp. pro přesné ustavení indikátoru na vozidle
- Plastová skříňka
- Vložka z měkké pěny



2155 N-25



2155-60



2155-65

HAZET No.	€
4968/3	174,-



Speciální nářadí

Servis brzd



4968 Univerzální brzdový kufřík

• Všechny důležité nástroje v přímém přístupu



- Použití: Demontáž/montáž brzd a rovněž k profesionální čistění brzd
- Plastová skříňka
- Vložka z měkké pěny



751 K HS-3

8801 K • O • $\frac{10}{16}$
7

751 K HS-4

986 • O • $\frac{10}{16}$
9

748 LGB
748 Lg b-3
• 748 Lg b-4

986 LG • O • $\frac{10}{16}$
9 • 11

2784 • O • $\frac{10}{16}$
7

4968-2

810 U-PH • \odot
PH 3

2584-8 • O • $\frac{10}{16}$
8

2901 G • O • $\frac{10}{16}$
7

4968-6

HAZET No.		EAN-No. 4000896+	€
4968/14 A	14	221158	218,10

4969 Pneumatická sada pro odvzdušnění brzd

• Odvzdušňovací přístroj pro odsátí brzdové kapaliny z brzdových válců kola / brzdových sedel



- Vhodné i pro zařízení ABS (pozor: **dodržujte pokyny výrobce**)
- Integrovaný Venturiho systém vytváří pomocí stlačeného vzduchu vakuum, které slouží k odvzdušnění brzdového systému
- Včetně univerzální pryžové vsuvky pro všechna vozidla
- Průhledná hadice pro odvzdušnění brzd slouží k vizuální kontrole
- Spotřeba vzduchu 180 l/min / pracovní tlak 6 až 8 barů
- Včetně spojovacího konektoru, jmenovitá světlost 7,2
- Obsah:
 - 1 odvzdušňovač brzd (objem nádoby 0,75 l)
 - 1 doplňovací nádoba s pevným nástavcem
 - 1 nádoba s nastavitelným nástavcem (objem každé nádoby 1 liter)

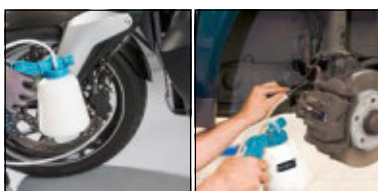

HAZET No.		EAN-No. 4000896+	€
4969-1/3	3	149445	102,80

4968 Sada háků

- Použití: Bezpečné zavěšení demontovaných součástí, např. brzdových sedel, zabraňuje poškození brzdových hadiček, vedení atd.
- Univerzálně použitelná
- Ø háku: 7 mm
- Povrch: lakováno máčením



HAZET No.	l mm	EAN-No. 4000896+	€
4968/2 H	190	221820	12,35

Použití výrobku

Sety pro zpětné nastavení brzdových pístů
hazet.de → Servis → Poradce pro použití
 → Sety pro zpětné nastavení brzdových pístů

◀ Pro smartphony s aplikací QR Reader

4970 Sada pro zpětné ustavení brzdových pístů

Made in Germany



• S axiálním ložiskem, otočným doleva a doprava

- Použití: Pro zpětné ustavení brzdových pístů na plovoucích brzdových třmenech s blokovacím zařízením ruční brzdy nebo bez něj
- Axiální ložisko zabraňuje poškození prachovky
- Doplňkový vnější šestihran s 13 mm pro flexibilní nástavec poháněcího nářadí, např. ráčny
- Univerzální – vhodný pro všechny běžné typy vozidel
- Přířazení: www.hazet.de → Poradce pro použití → Sada pro vrácení brzdových pístů
- Ovládání (otáčení) brzdového pístu se provádí přes vnější šestihran, který se nachází přímo na příslušném adaptéru. Tím je zaručen optimální přenos síly
- Plastová skříňka



YouTube Clip



HAZET No.		EAN-No. 4000896+	€
4970/6	6	088867	229,10
4970/9	9	157464	287,10



4970 Základní přístroj

Made in Germany

Použití: Pro zpětné nastavení brzdových pístů na plovoucích brzdových třmenech s blokovacím zařízením ruční brzdou nebo bez něj

Základní přístroj

- Axiální ložisko zabraňuje poškození prachovky
- Doplňkový vnější šestihran s 13 mm pro flexibilní nástavec poháněcího nářadí, např. ráčny



YouTube Clip

HAZET No.	EAN-No. 4000896+	€
4970-1	088874	163,60

4970 Sada nástrojů k nastavení brzdového pístu zpět · pneumatická

Univerzálně použitelný díky 3dílné sadě adaptérů. Optimalizace základního přístroje HAZET 4970 P-1

- Použití: Pro zpětné nastavení brzdových pístů na plovoucích brzdových třmenech s blokovacím zařízením ruční brzdou nebo bez něj
- Pro pravotočivé a levotočivé brzdové písty
- Největší možný zpětný pohyb pístnice až do pouzdra – manipulace i u zvlášť daleko vyjetého brzdového pístu
- Pro nejmenší brzdový třmen **Mini** · **BMW** řada 1 až **BMW X7** (aktuálně největší brzdový třmen)
- Pneumatická podpora ve spojení s otočnou pákou umožňuje snadné a rychlé nastavení zpět bez vynaložení síly
- Je možné současné tlačení a otáčení příp. jen tlačení brzdového pístu po výměně brzdového obložení u zařízení kotoučových brzd
- Obsažená sada adaptérů 4970 P-02/3 zaručuje flexibilní uchycení tlačných desek jiných výrobců na trhu např.:
 - Adaptér s vnitřním šestihranem s 13 mm pro tlačné desky HAZET skupiny produktů 4970
 - 10 mm (3/8") adaptér s vnějším čtyřhranem ke spojení speciálních adaptérů OEM např. všechny aktuální adaptéry **Mini** a **BMW** · SW-Stahl
 - 2-čepový adaptér m. j. pro VIGOR · SW-Stahl · KS-Tools · Facom · BGS · Kunzer
- V kufru s vložkou z měkké pěny a možností uschování dalších adaptérů
- Včetně návodu k obsluze



YouTube Clip



12.91 (€) 9000-010 7.2



4970/5

4970 P-02/3

HAZET No.	€
4970 P-1/4	154,20

Sada adaptérů

- K adaptaci tlačných desek různých výrobců na základní přístroj HAZET 4970 P-1:
- Adaptér s vnitřním šestihranem s 13 mm pro tlačné desky HAZET skupiny produktů 4970
- 10 mm (3/8") adaptér s vnějším čtyřhranem ke spojení speciálních adaptérů OEM např. všechny aktuální adaptéry **Mini** a **BMW** · brzdový třmen BMW řady 1 až X7 (aktuálně největší třmen)
- 2-čepový adaptér m. j. pro VIGOR · SW-Stahl · KS-Tools · Facom · BGS · Kunzer

4970 P-02/3	3	234929	29,50
-------------	---	--------	-------

4970 Sada nástrojů k nastavení brzdového pístu zpět · pneumatická

HAZET No.	EAN-No. 4000896+	€
-----------	------------------	---

Sada tlačných desek

- Univerzálně použitelná pro mnoho typů vozidel
- Ve spojení např. se sadou nástrojů k nastavení brzdového pístu zpět 4970 P-1/4 a 4971-1
- Dodržujte pokyny výrobce a dbejte na provedení brzdového třmenu
- Tlačná deska 4970-5 se 2 čepy pro:
 - AUDI · A4 · r. v. 2007→2015
 - CITROËN · Berlingo 5 · r. v. 2008→2018
 - FIAT · Bravo · r. v. 2007→2014
 - FORD · Kuga · r. v. 2008→2012 · Mondeo · r. v. 2007→2014 · Transit · r. v. 2006→2013
 - OPEL · Insignia · r. v. 2008→2017 · Zafira B · r. v. 2005→2014
 - PEUGEOT · 407 · r. v. 2004→2011 · 508 · r. v. 2010→2018
 - RENAULT · Trafic · r. v. 2001→2014
 - SEAT · Altea · r. v. 2004→2015
 - ŠKODA · Octavia · r. v. 2004→2012 · Roomster · r. v. 2006→2015
 - VOLKSWAGEN · T5 · r. v. 2003→2015 · Touran · r. v. 2003→2015
- Tlačná deska 4970-6 vnitřní šestihran 12 mm
 - AUDI · VOLKSWAGEN
- Tlačná deska 4970-7 se 2 čepy pro:
 - FIAT · 500 · r. v. 2007→
 - MERCEDES-BENZ · Citan · r. v. 2012→
 - RENAULT · Kangoo · r. v. 2008→2013 · Modus · r. v. 2004→2012
- Tlačná deska 4970-8 se 2 čepy pro:
 - AUDI · CITROËN · VOLKSWAGEN
- Tlačná deska 4970-9 se 4 čepy pro:
 - MINI · Cooper · r. v. 2006→2016
 - SAAB

4970/5	5	235544	98,65
--------	---	--------	-------

4970 Jednotlivé díly k 4970

Made in Germany

Použití: Pro zpětné nastavení brzdových pístů na plovoucích brzdových třmenech s blokovacím zařízením ruční brzdou nebo bez něj

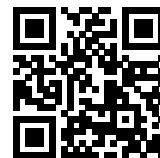

YouTube Clip

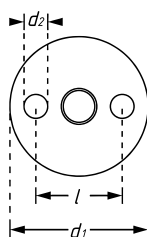

HAZET No.	l mm	d ₁ mm	d ₂ mm	EAN-No. 4000896+	€
-----------	------	-------------------	-------------------	------------------	---

- Tlačná deska se 2 čepy pro:
 - AUDI · A4 · r. v. 2007→2015
 - CITROËN · Berlingo 5 · r. v. 2008→2018
 - FIAT · Bravo · r. v. 2007→2014
 - FORD · Kuga · r. v. 2008→2012 · Mondeo · r. v. 2007→2014 · Transit · r. v. 2006→2013
 - OPEL · Insignia · r. v. 2008→2017 · Zafira B · r. v. 2005→2014
 - PEUGEOT · 407 · r. v. 2004→2011 · 508 · r. v. 2010→2018
 - RENAULT · Trafic · r. v. 2001→2014
 - SEAT · Altea · r. v. 2004→2015
 - ŠKODA · Octavia · r. v. 2004→2012 · Roomster · r. v. 2006→2015
 - VOLKSWAGEN · T5 · r. v. 2003→2015 · Touran · r. v. 2003→2015

4970-5	29	35	5	052943	29,35
--------	----	----	---	--------	-------

- Tlačná deska vnitřní šestihran 12 mm
- AUDI · VOLKSWAGEN
- Dbejte na provedení brzdového třmenu

4970-6	-	30	-	052950	14,15
--------	---	----	---	--------	-------



Speciální nářadí

Servis brzd



4970 Jednotlivé díly k 4970

HAZET No.	l mm	d ₁ mm	d ₂ mm	EAN-No. 4000896+	€
• Tlačná deska se 2 čepy pro: – FIAT · 500 · r. v. 2007→ – MERCEDES-BENZ · Citan · r. v. 2012→ – RENAULT · Kangoo · r. v. 2008→2013 · Modus · r. v. 2004→2012					
4970-7	24	32	6	052967	29,-
• Tlačná deska se 2 čepy pro: – AUDI · Dbejte na provedení brzdového třmenu – CITROËN · Dbejte na provedení brzdového třmenu – VOLKSWAGEN					
4970-8	44	55	6	052974	38,85
• Tlačná deska se 4 čepy pro: – MINI · Cooper · r. v. 2006→2016 – SAAB · Dbejte na provedení brzdového třmenu					
4970-9	22	30	5	052981	31,15
• Tlačná deska se 2 čepy pro: FORD · Transit · r. v. 2006→2013					
4970-10	20	35	6	126019	28,50
• Tlačná deska se 2 čepy pro: FIAT · Panda · r. v. 2003→2012					
4970-11	20	35	3	146581	28,65
• Tlačná deska se 2 čepy pro: FORD · S-Max · r. v. 2006→2014 · brzda zadních kol					
4970-12	20	40	5	149766	29,05

4971 Nářadí pro zpětné nastavení brzdových pístů

Made in Germany

• Rychlé a rovnoměrné vrácení bez vzpříčení

- Použití: Pro návrat brzdových pístů bez poškození (posuvné/pevné třmeny) u kotoučových brzd
- Pro běžné typy vozidel bez integrovaného zajištění ruční brzdy
- Obrana proti poškození manžet a pístů
- Vysoká přesnost a velká stabilita umožňují stálé používání
- Menší námaha díky přesným vedením



HAZET No.	EAN-No. 4000896+	€
4971-1	156245	159,50

796 Kleště na brzdové pružiny

Made in Germany

- Použití: Zavěšování a vyvážování zpětné pružiny brzdových čelistí u nýtovaných brzdových čelistí
- Povrch: chromováno



HAZET No.	l mm	EAN-No. 4000896+	€
796	215	031818	35,90

797 Kleště na brzdové pružiny

Made in Germany

• Pohyblivý dráp

- Použití: Pro lepené a nýtované brzdové destičky (bubnové brzdy vzadu)
- Povrch: chromováno



HAZET No.	l mm	EAN-No. 4000896+	€
797	317	031825	73,25

1846 B Kleště na pojistné kroužky

Made in Germany

• Dlouhé špičky zahnuté 90°

- Použití: Ovládání nízko uložených pojistných kroužků např. u brzdových třmenů a převodovek
- Čelisti zahnuté v úhlu 90°
- Ergonomické 2komponentní plastové kryty rukojetí HAZET (modrá/černá)
- Povrch: chromováno

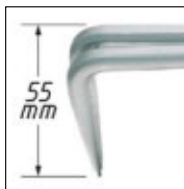

HAZET No.	l mm	● mm	≡ mm	EAN-No. 4000896+	€
1846 b-1.6	195	12-30	1,5	061457	49,90

4968 Pružné kleště na lanko ruční brzdy

Made in Germany

- Úspora času díky rychlé bezpečné práci
- Jednoduchá manipulace

- Použití: Demontáž a montáž lanka ruční brzdy na brzdové čelisti bubnových brzd
- Otvírací pružina a doraz
- Funkční plochy v přední oblasti tvrzené
- Povrch: špička mořená



HAZET No.	l mm	EAN-No. 4000896+	€
4968-4	227	084760	40,55



Podvozek

Stahovák pružin / tlumič



Použití výrobku

Databáze stahováků pružin
hazet.de → Servis → Poradce pro použití
 → Databáze stahováků pružin
 ◀ Pro smartphony s aplikací QR Reader

4900 Základní přístroj bezpečnostního stahováku pružin

Made in Germany



- Montáž a demontáž vinutých pružin při výměně tlumiče pérování
 Použití asi u 200 různých typů vozidel
- Použití: Spirálová pružina při výměně tlumiče (povšimněte si přiřazovací tabulky stahováků pružin na internetu nebo v příručce nástrojů)
- Max. dráha upnutí 309 mm
- Vysoké zatížení až 26000 N
- Vhodné pro použití rázového utahováku, např. HAZET 9012 EL-SPC nebo 9012 MT ve spojení s nástrčnou hlavicí HAZET 900 S-27 nebo 900 S Lg-27
- Uzavřený systém – **Bezúdržbový!**
- Variabilní systém díky rychle vyměnitelným párům upínacích desek
- Lišta pro upnutí do svěráku
- Značka GS – ověřená bezpečnost
- Válec a vodicí trubka zušlechtěné
- Upínací desky kované a zušlechtěné
- Také pro pružící jednotky s tažnou dorazovou pružinou v tlumiči pérování



YouTube Clip

HAZET No.	Ø mm	FAN-No. 4000896+	€
Základní přístroj bezpečnostního stahováku pružin			
4900-2 A	–	077267	952,-
• Sada náhradních dílů pro stahovák pružin 4900-1 A a -2 A se skládá ze 2 válcových kolíků a 1 O-kroužku			
4900-02 A/3	7	069415	14,60
• Sada náhradních dílů pro stahovák pružin 4900-1 a 4900-2 se skládá z 5 válcových kolíků a 2 O-kroužků			
4900-02/7	6	063437	33,95

4900 Sada bezpečnostních stahováků pružin

Made in Germany



• Vhodné pro rázové utahováky

- Použití: Pro montáž a demontáž spirálových pružin při výměně tlumičů
- Uzavřený systém – **Bezúdržbový!**
- Variabilní systém díky rychle vyměnitelným párům upínacích desek
- Plastové vložky k ochraně lakovaných povrchů pružin. Tím nehrozí nebezpečí poškození pružin vlivem koroze
- Lišta pro upnutí do svěráku
- 4900-2 A také pro pružící jednotky s tažnou dorazovou pružinou v tlumiči pérování
- Max. dráha upnutí: 309 mm
- Vysoké zatížení až 26000 N
- Značka GS – ověřená bezpečnost
- Válec a vodicí trubka zušlechtěné
- Upínací desky kované a zušlechtěné



YouTube Clip



4900-2 A/3

HAZET No.		FAN-No. 4000896+	€
• 1 základní přístroj a 2 upínací desky 4900-11			
• Použitelné pro asi 50 různých typů vozidel			
4900-2 A/3	3	149483	1269,-
• 1 základní přístroj a 4 upínací desky (2x 4900-11 a 2x 4900-12). Použitelné u asi 100 různých typů vozidel			
4900-2 A/5	5	086054	1693,-





Speciální nářadí

Podvozek – Stahovák pružin / tlumič



4900 Upínací deska

Made in Germany

- (Cena za kus)
- Použití viz přiřazovací tabulka



HAZET No.	EAN-No. 4000896+	€
4900-10	059706	177,30
• Plastová vložka pro ochranu lakovaných povrchů pružin. Nehrozí proto nebezpečí poškození pružin vlivem koroze		
4900-100	061136	20,50

Made in Germany

- (Cena za kus)
- Použití viz přiřazovací tabulka



HAZET No.	EAN-No. 4000896+	€
4900-11	059713	179,10
• Plastová vložka pro ochranu lakovaných povrchů pružin. Nehrozí proto nebezpečí poškození pružin vlivem koroze		
4900-110	061143	20,50

Made in Germany

- (Cena za kus)
- Použití viz přiřazovací tabulka



HAZET No.	EAN-No. 4000896+	€
4900-12	059720	228,30
• Plastová vložka pro ochranu lakovaných povrchů pružin. Nehrozí proto nebezpečí poškození pružin vlivem koroze		
4900-120	061150	20,50

Made in Germany

- (Cena za kus)
- Použití viz přiřazovací tabulka

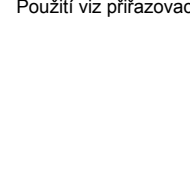

HAZET No.	EAN-No. 4000896+	€
4900-13	059737	251,40

4900 Upínací deska

Made in Germany

- (Cena za kus)
- Použití viz přiřazovací tabulka



HAZET No.	EAN-No. 4000896+	€
4900-14 A	064649	186,80

Made in Germany

- (Cena za kus)
- Použití viz přiřazovací tabulka



HAZET No.	EAN-No. 4000896+	€
4900-15 A	121472	187,40

Made in Germany

- (Cena za kus)
- Použití viz přiřazovací tabulka



HAZET No.	EAN-No. 4000896+	€
4900-16	062164	175,60

Made in Germany

- (Cena za kus)
- Použití viz přiřazovací tabulka



HAZET No.	EAN-No. 4000896+	€
4900-17	062171	232,80

Made in Germany

- (Cena za kus)
- Použití viz přiřazovací tabulka



HAZET No.	EAN-No. 4000896+	€
4900-18	100378	375,60
• Plastová vložka pro ochranu lakovaných povrchů pružin. Nehrozí proto nebezpečí poškození pružin vlivem koroze		
4900-180	074327	21,20



4900 Upínací deska

Made in Germany

- (Cena za kus)
- Použití viz přiřazovací tabulka



HAZET No.	EAN-No. 4000896+	€
4900-19	085842	244,70

Made in Germany

- (Cena za kus)
- Použití viz přiřazovací tabulka



HAZET No.	EAN-No. 4000896+	€
4900-22	062188	247,90

Made in Germany

- (Cena za kus)
- Použití viz přiřazovací tabulka



HAZET No.	EAN-No. 4000896+	€
4900-23	062195	279,40

Made in Germany

- (Cena za kus)
- Použití viz přiřazovací tabulka



4900-243



HAZET No.	EAN-No. 4000896+	€
4900-24	062201	302,80

Vymezovací kroužek pro upínací desku 4900-24

- Mimořádně vhodné, pokud již existuje 4900-22 a 4900-24

4900-243	162932	132,10
----------	--------	--------

4900 Upínací deska

Made in Germany

- (Cena za kus)
- Použití viz přiřazovací tabulka



HAZET No.	EAN-No. 4000896+	€
4900-25	121670	234,80

- Pro ocelovými pružinami odpruženou kabinu řidiče **MERCEDES-BENZ** Actros (MP-1) r. v. 1996 → · Atego r. v. 1998 →

Made in Germany

- (Cena za kus)
- Použití viz přiřazovací tabulka



HAZET No.	EAN-No. 4000896+	€
4900-26	121687	243,-

- Pro ocelovými pružinami odpruženou kabinu řidiče **MERCEDES-BENZ** Actros (MP-1) r. v. 1996 → · Atego r. v. 1998 →

Made in Germany

- (Cena za kus)
- Použití viz přiřazovací tabulka



HAZET No.	EAN-No. 4000896+	€
4900-30	100514	326,20

Made in Germany

- (Cena za kus)
- Použití viz přiřazovací tabulka



4900-310



HAZET No.	EAN-No. 4000896+	€
4900-31	138036	278,30

- **Plastová vložka** pro ochranu lakovaných povrchů pružin. Nehrozí proto nebezpečí poškození pružin vlivem koroze

4900-310	167715	22,05
----------	--------	-------



Speciální nářadí

Podvozek – Stahovák pružin / tlumič



4900 Upínací deska

Made in Germany

- (Cena za kus)
- Použití viz přiřazovací tabulka



HAZET No.	EAN-No. 4000896+	€
4900-33	138043	318,20

4900 Upínací deska

Made in Germany

- (Cena za kus)
- Použití viz přiřazovací tabulka



HAZET No.	EAN-No. 4000896+	€
4900-35	121212	217,90

4900 MERCEDES-BENZ sada upínacích desek stahováku pružin

Made in Germany

• S brzdou

- Použití: Pro manipulaci se šroubovými pružinami přední nápravy u vozidel **MERCEDES-BENZ**, typ 204 (třída C), typ X 204 (třída GLK), typ 212 (třída E se standardním podvozkem) / typ 212 (třída E se sportovním podvozkem)
- (Cena za kus)
- Použití viz přiřazovací tabulka
- Použití ve spojení s bezpečným stahovákem pružin HAZET 4900-2A
- Bezpečné uchycení těchto pružících jednotek s otočným uložením
- Použití s bezpečným stahovákem pružin HAZET 4900-2A, vhodnou upínací deskou např. 4900-17 a vhodnou středící vložkou (v závislosti na modelu vozidla. Pozor: Dodržte specifikaci výrobce vozidla)

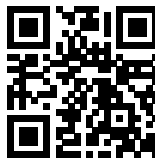

YouTube Clip

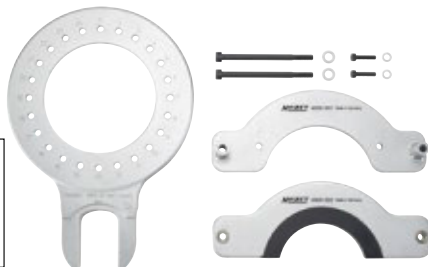
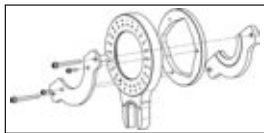

HAZET No.	Quantity	EAN-No. 4000896+	€
4900-39/11	11	167678	652,-
Středící vložka pro MERCEDES-BENZ, typ 204 (třída C)			
• Použití s bezpečným stahovákem pružin HAZET 4900-2 A, upínací deskou 4900-17, jakož i otočnou deskou s brzdou 4900-39/11			
4900-393	-	167722	89,35
Středící vložka pro MERCEDES-BENZ, typ X204 (třída GLK)			
• Použití s bezpečným stahovákem pružin HAZET 4900-2 A, upínací deskou 4900-17 a krycí vložkou 4900-120, jakož i otočnou upínací deskou s brzdou 4900-39/11			
4900-394	-	167739	99,75
Středící vložka pro MERCEDES-BENZ, typ 212 (třída E) se standardním podvozkem			
• Použití s bezpečným stahovákem pružin HAZET 4900-2 A, upínací deskou 4900-31 a krycí vložkou 4900-310, jakož i otočnou upínací deskou s brzdou 4900-39/11			
4900-395	-	167746	96,20
Středící vložka pro MERCEDES-BENZ, typ 212 (třída E) se sportovním podvozkem			
• Použití s bezpečným stahovákem pružin HAZET 4900-2 A, upínací deskou 4900-17, jakož i otočnou deskou s brzdou 4900-39/11			
4900-396	-	167753	182,40

HAZET – všechno sedí – bezpečně!

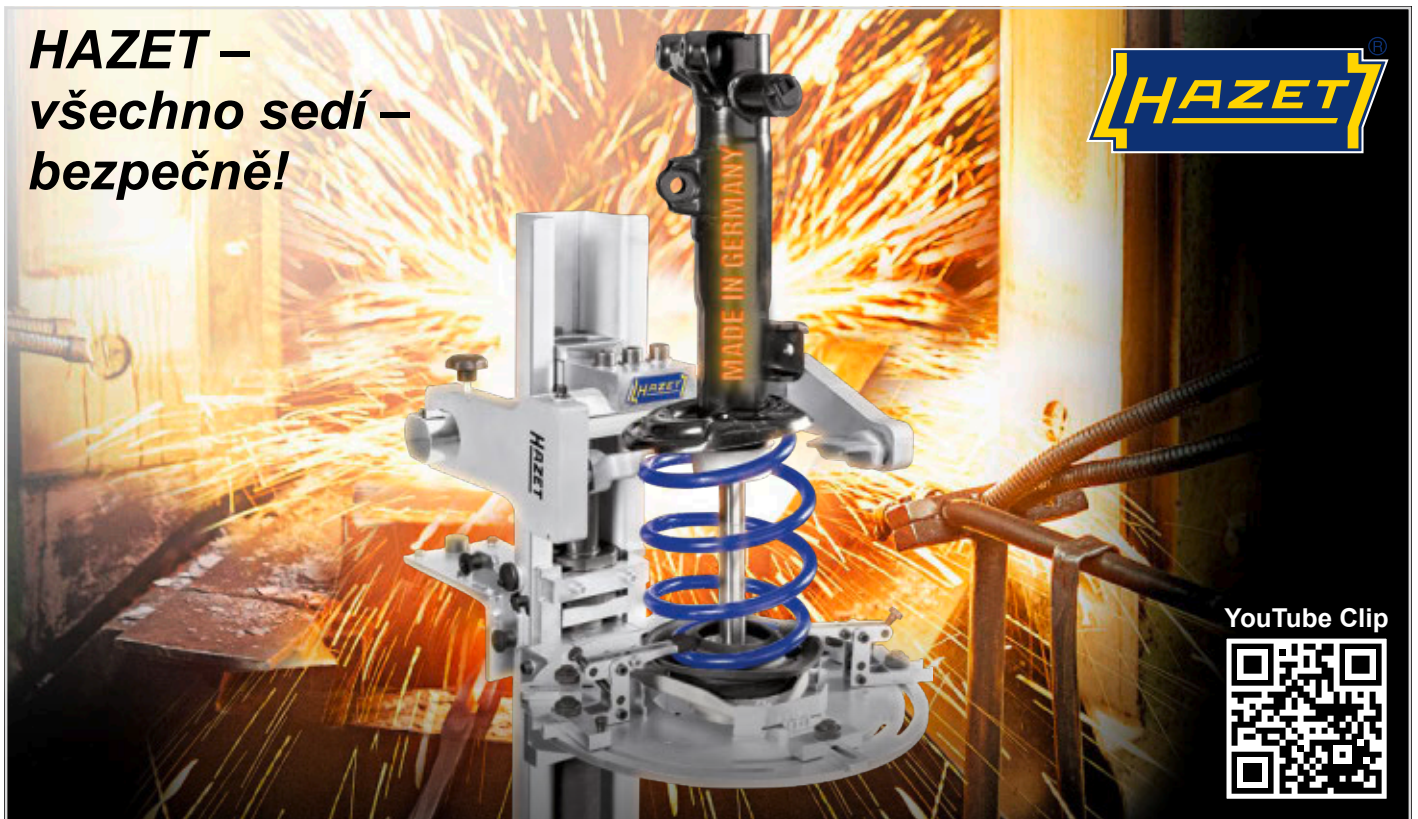

YouTube Clip





Příklady přiřazení:

Další informace a údaje pro starší roky výroby najdete také na internetu na webových stránkách: www.hazet.de → Servis → Poradce pro použití → Databáze stahováků pružin

Technické změny výrobců vozidel vyhrazeny

* = Aktuálně nejsou k dispozici žádné informace.

** = Pokyny výrobce vozidla je nutné vždy dodržovat.

Předpis BMW: Stahovák pružin ovládejte pouze pomocí ručního nářadí.



























































Typ	Rok výroby	Upínací desky	Plastové vložky / středící vložky	Upínací desky	Plastové vložky / středící vložky
ALFA ROMEO					
Alfa 147	2003	4900-11 (2x)		4900-11 (2x)	
Mito	2009	4900-11 (2x)		4900-11 (2x)	
AUDI					
A3	2000→	4900-11 (2x)		4900-10 (2x)	*
A5	2007→	4900-12 (2x)		*	*
BMW					
1 (E87) **: 116i / 118i / 120i / 118d / 120d	2004→	4900-22 24		4900-243	4902/6 -
3 (E46) ** 318ti Compact	2001	4900-12 (2x)			
3 (E90) **: 320i / 325i / 330i / 320d Limousine	2004→	4900-22 24		4900-243	4902/6 -
3 (E91) **: 320 / 325 / 330 / Touring	2005→	4900-22 24		4900-243	4902/6 -
3 (E92): 320 / 323 / 325 / 328 / 330 / 335	2005→	4900-22 24		4900-243	
3 (E93): 320 / 325 / 328 / 330 / 335	2006→	4900-22 24		4900-243	
5 (E60) **	2004→	4900-22 24		4900-220	* *
5 (F10)	2010→2015	4900-35 (2x)		4900-35 (2x)	
i3 (I01) Elektro	2013→	4900-35 (2x)		4900-35 (2x)	
i8 (I12) Hybrid	2013→	4900-35 (2x)		4900-35 (2x)	
Mini Cooper	2001→	4900-11 (2x)		4900-10 11	
X3 (E83)	2006→	4900-31 33			
X5 (E70)	2006	4900-10 11		4900-100 110	
CITROËN					
C-Crosser	2007→2013	4900-11 (2x)			
C1	2005→2013	4900-11 (2x)		4900-11 (2x)	
Nemo	2008	4900-11 (2x)		4900-11 (2x)	
DACIA					
Logan 1,6i	2005→	4900-11 (2x)		*	* *
FIAT					
500	2007→	4900-12 (2x)			
Doblò	2010	4900-11 (2x)		4900-11 (2x)	
Ducato	2006	4900-13 (2x)			
Grande Punto	2005→	4900-11 (2x)		*	4900-11 (2x) *
Qubo	2009	4900-12 (2x)		4900-12 (2x)	
Stilo	2002	4900-11 (2x)		*	* *
FORD					
C-Max	2006	4900-12 (2x)			



Speciální nářadí

Podvozek – Stahovák pružin / tlumič



 Typ	 Rok výroby	Upínací desky		Plastové vložky / středící vložky	Upínací desky		Plastové vložky / středící vložky
FORD							
Fiesta	2002→2005	4900-11 (2x)					
Fiesta	2005→2008	4900-11 (2x)					
Fiesta	2009→	4900-12 (2x)					
Focus	2004→2010	4900-12 (2x)			4900-10 (2x)		
Focus	2007	4900-12 (2x)					
Focus	2010→	4900-11 (2x)			4900-10 (2x)		
Fusion	2005	4900-11 (2x)					
Ka	1996→2008	4900-11 (2x)			4900-10 (2x)		
Mondeo	2000→2007	4900-12 (2x)			4900-11 (2x)		
Mondeo	2008→	4900-12 (2x)					
S-Max	2006	4900-11 (2x)					
MAZDA							
2 / DY	2003→2007	4900-11 (2x)					
6 / GY	2002→2007	4900-11 (2x)					
MERCEDES-BENZ							
Třída A, typ 169	2004→	4900-17 (2x)		*	4900-35 (2x)		*
Třída B, typ 245	2005	4900-17 (2x)			4900-35 (2x)		
Třída C, typ 203	2000→	4900-17 18		4900-180	*		*
Třída C, typ 204	2007→2015	4900-39/11 17		4900-393			
Citan, typ 415	2012→	4900-17 (2x)		4900-120 (2x)	4900-17 (2x)		4900-120
Třída E, typ 211 / typ 219	2002→	4900-19 30		*	*		*
Třída E, typ 212	2009→2016	4900-39/11 31		4900-395 310			
Třída E, typ 212 sportovní podvozek	2009→	4900-39/11 17		4900-396			
Třída GLK, typ X204	2008→2015	4900-39/11 17		4900-394 120			
Třída ML, typ 164	2005→	4900-35 (2x)		*	*		*
Třída ML, typ 166	2011→2015	4900-35 (2x)					
Třída SL, typ 231	2012→	4900-16 (2x)			4900-16 (2x)		
Vito, třída V, typ 639	2003→2014	4900-23 (2x)		4900-23 (2x)	*		*
OPEL							
Astra H	2004→2010	4900-12 (2x)		*	*		*
Astra J	2009→2012	4900-12 (2x)					
Corsa C	2000→2006	4900-11 (2x)					
Corsa D	2006	4900-11 (2x)			4900-10		
Meriva	2010→	4900-11 (2x)					
Vectra C	2002→2008	4900-12 (2x)		*	*		*
PEUGEOT							
307 SW	2002→2008	4900-11 (2x)			4900-12 (2x)		
Boxer	*	4900-13 (2x)		*	*		*
Partner	2006	4900-12 (2x)					
PORSCHE							
Boxster / Boxster S (typ 987)	2004	4900-15 A 22		*	4900-22 (2x)		*
Carrera 2 / 4 (typ 997)	2004	4900-15 A 22		*	4900-22 (2x)		*
Cayenne	2004→	4900-16 (2x)		*	4900-16 (2x)		*
Cayman	2006→	4900-15 A 22		*	4900-22 (2x)		*
RENAULT							
Clio 2	2001	4900-11 (2x)					



Typ	Rok výroby	Upínací desky		Plastové vložky / středící vložky	Upínací desky		Plastové vložky / středící vložky
RENAULT							
Clio 3 1,5 dci	2005	4900-12 (2x)		4900-120 (2x)	*		*
Espace 2	2004	4900-13 (2x)			4900-13 (2x)		
Espace 2,0 turbo	2003	4900-17 (2x)		*	*		*
Kangoo 1,5	2004	4900-15 A (2x)		*	*		*
Laguna 2,0 dci	2005→	4900-12 (2x)		*	4900-11 (2x)		*
Mégane 2 1,9dci	2003→2008	4900-12 (2x)		4900-120 (2x)	*		*
Mégane 3	2008→	4900-12 (2x)					
Modus 1,5dci	2005→	4900-12 (2x)		*	*		*
Scénic 1,5dci	2005→	4900-12 (2x)		4900-120 (2x)	*		*
Traffic	2005	4900-11 (2x)			4900-11 (2x)		
Twingo	2007→	4900-11 (2x)		*	*		*
SAAB							
93	2002	4900-12 (2x)			4900-12 (2x)		
SEAT							
Altea	2006	4900-11 (2x)					
Ibiza	2002	4900-11 (2x)		*	4900-10 (2x)		*
Ibiza	2006	4900-11 (2x)					
León	2002	4900-11 (2x)		*	4900-10 (2x)		*
ŠKODA							
Fabia	2001	4900-11 (2x)		*	*		*
Rapid	2012→	4900-11 (2x)					
Roomster	2007	4900-11 (2x)			4900-11 (2x)		
Superb	2002	4900-11 (2x)		*	*		*
Yeti	2009→2013	4900-11 (2x)					
SMART							
fortwo	2009	4900-10 (2x)					
SUZUKI							
Wagon R+	2000→2006	4900-10 (2x)		*	*		*
VOLKSWAGEN							
Amarok	2010	4900-11 (2x)					
Caddy	2006	4900-11 (2x)					
Golf 5	2003→2008	4900-11 (2x)					
Golf 6	2008→2012	4900-11 (2x)					
Lupo	2001	4900-11 (2x)					
Passat 3C	2010→	4900-11 (2x)			4900-10 (2x)		
Passat B5	1996→2005	4900-11 (2x)					
Passat B6	2005→2010	4900-11 (2x)					
Polo	2001→2009	4900-11 (2x)			4900-11 (2x)		
Polo 6R	2009→	4900-11 (2x)					
Polo 9N	2006	4900-11 (2x)					
Sharan	1995→2010	*			4900-12 (2x)		
Sharan	2010→				4900-10 (2x)		
T5 (Transporter)	2003→	4900-13 (2x)			4900-12 (2x)		
Tiguan	2008	4900-11 (2x)					
Touran	2003→	4900-11 (2x)			4900-10 (2x)		
Touran	2010→	4900-11 (2x)					



Speciální nářadí

Podvozek – Stahovák pružin / tlumič



4902 Sada vnitřních stahováků pružin

Made in Germany

• Vnitřní vedení upínací desky zabraňuje vyklouznutí pružiny



- Použití: Demontáž a montáž závitové pružiny zadní osa **AUDI** A4 se standardním podvozkem
- Výkyvná 6hran. hlava pro stejnoměrné rozdělení síly s integrovanou ochranou proti otočení
- Je možné oboustranné přidržení vřetene
- Obsluha jednou osobou
- Je zamezeno uvolnění okolních konstrukčních dílů a také časově náročným vedlejším pracím:
 - odpadá demontáž dílů náprav
 - již není nutné proměřování náprav
- Demontáž a montáž vždy za 6 minut pro stranu – úspora času a nákladů

AUDI

A4 (8K2, B8) 1,8 TFSI, r. v. 2008 → 2016 · 2,0 TDI, r. v. 2008 → 2016 · 2,0 TFSI, r. v. 2008 → 2016 · 2,7 TDI r. v. 2007 → 2013

A4 Avant (8K5, B8) 1,8 TFSI quattro, r. v. 2008 → 2016 · 1,8 TFSI, r. v. 2008 → 2016 · 2,0 TDI quattro, r. v. 2008 → 2016 · 2,0 TDI, r. v. 2008 → 2016 · 2,0 TFSI quattro, r. v. 2008 → 2016 · 2,0 TFSI r. v. 2008 → 2016 · 3,0 TDI quattro r. v. 2008 → 2012 · 3,2 FSI quattro r. v. 2008 → 2012

A5 (8T-8F) r. v. 2007 → 2016

A6 (C7) r. v. 2011 → 2018

- Plastová skříňka

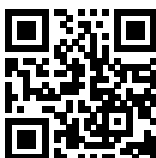

YouTube Clip

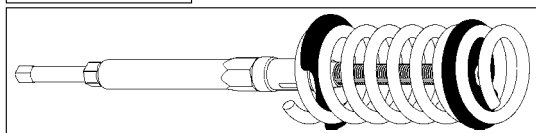

HAZET No.		EAN-No. 4000896+	€
• Sada vnitřních stahováků pružin, obsah: 4902-4 · 28 · 29 4902-224			
• Včetně návodu k obsluze			
4902/4	4	219308	457,50
• Stahovák pružin, vnitřní			
4902-4	–	219261	224,70
• Upínací deska			
4902-28	–	219278	115,10
4902-29	–	219285	86,60
• Trubkový oboustranný klíč sw 24 mm			
4902-224	–	122660	16,50

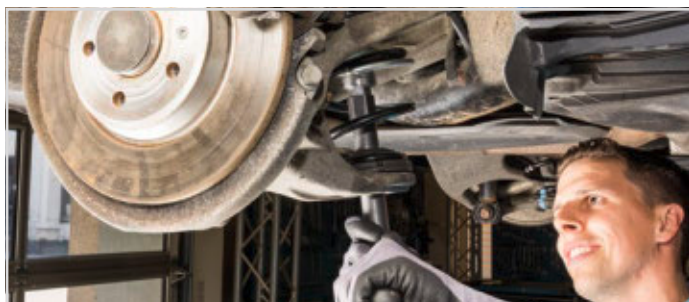

Jednotlivé a náhradní díly od strany 482 po stranu 490

4902 Sada vnitřních stahováků pružin

Made in Germany

• Použití: Montáž a demontáž šroubových pružin na zadní nápravě



• Optimálně upraveno pro stísněné prostory následujících vozidel

BMW

řada 1

- E87 - šikmá zád' r. v. 2003 → 2011
- E81 - šikmá zád' r. v. 2006 → 2013
- E82 - Coupé 2006 → 2014
- E88-Cabrio r. v. 2007 → 2015
- F20 · F21 r. v. 2011 → 2019

řada 2

- F22 · F23 · F87 r. v. 2013 →

řada 3

- E90 → stupňovitá zád' r. v. 2004 → 2012
- E91 → Touring r. v. 2004 → 2013
- E92 → Coupé r. v. 2005 → 2013
- E93 → Cabrio r. v. 2005 → 2013
- F30 · F31 · F34 · F35 · F80 r. v. 2011 → 2019

řada 4

- F32 · F33 · F36 · F82 · F83 r. v. 2013 → 2020

X1

- E84 r. v. 2009 → 2015

• Výkyvná 6hran. hlava pro stejnoměrné rozdělení síly s integrovanou ochranou proti otočení

• Vnitřní vedení upínací desky zabraňuje vyklouznutí pružiny

• Je možné oboustranné přidržení vřetene

• Plastová skříňka



YouTube Clip

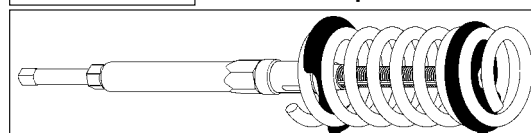

HAZET No.	l mm		EAN-No. 4000896+	€
• Sada vnitřních stahováků pružin, obsah: 4902-1 · 10 · 11 · 210 · 224 4910-1				
4902/6	–	6	121694	503,-
• Stahovák pružin, vnitřní				
4902-1	–	–	122639	224,70
• Upínací deska				
4902-10	–	–	122646	93,15
4902-11	–	–	122653	64,70
• Trubkový oboustranný klíč sw 10 mm				
4902-210	–	–	122677	9,95
• Trubkový oboustranný klíč sw 24 mm				
4902-224	–	–	122660	16,50
• Přepínací ráčna				
• Výstup dvojité šestihran 21 mm				
4910-1	275	–	062133	81,40

Nezávazně doporučená ceníková cena bez DPH – Platí do 31.12.2021



4903 Univerzální stahovák pružin

Made in Germany

• Vyšší bezpečnost – díky montáži bez zatížení

• Univerzální použití pro téměř všechny pružicí/tlumičí jednotky
• Demontáž/montáž bez zatížení při zcela odlehčeném tlumiči

Inovativní koncept uchycení a montáže

• Sklopný do vodorovné nebo svislé pracovní polohy
HAZET doporučuje ergonomickou pracovní výšku: svislá pro nastavení, vodorovná pro manipulace

• Je vyloučeno poškození tlumiče a horního uložení (přetížení je nemožné)

• Jednoduché aretační a fixační uchycení tlumiče pérování

Vysoká bezpečnost

• Průchozí bezpečné uchycení horního uložení

• Poškození závitu na pístnici je vyloučeno

• Trvalé zajištění pružiny během celého pracovního procesu

Bezpečnost investice – použití stávajících komponentů SYSTEM 4900

• Použití stávajícího základního přístroje 4900-2 A a všech upínacích desek ze SYSTEMu 4900

• Použití s budoucími tlumiči je zajištěno

Možnost dokumentace díky měřítku

• Znatelná úspora času v případě opakování

• S pevnou fixací není zapotřebí nové nastavení u stejného tlumiče pérování (pravý/levý)

4 kroky k úspěchu:

1. Tlumič pérování zafixovat na upínací talíř nad uchycovač a brzdy
2. Pružinu uchytit s univerzální upínací deskou
3. Upínákem manipulovat s přepínací ráčnou, Aku šroubovákem nebo pneumatickým ráčnovým šroubovákem
4. Tlumič bez zatížení demontovat a namontovat nový (potom v obráceném pořadí)



YouTube Clip

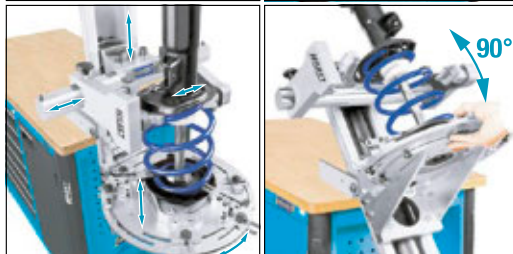
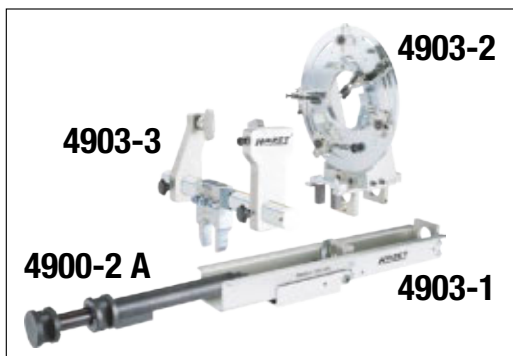

HAZET No.		EAN-No. 4000896+	€
	• Základní nosník pro uchycení základního stahováku pružin (včetně bezpečnostního adaptéru) • Perfektní základní výbava, když je základní stahovák pružin 4900-2 A již k dispozici		
4903-1	–	179824	792,-
	• Použitím upínacího talíře a univerzální upínací desky bude základní nosník 4903-1 resp. sada 4903/2 A pro plnohodnotný univerzální stahovák pružin		
	• 2dílná sada, obsah: • 4903-2 univerzální upínací talíř, nastavitelný • 4903-3 univerzální upínací deska, nastavitelná, včetně bezpečnostního adaptéru		
4903/2	2	180530	2820,-
	• Perfektní startovací sada pro demontáž a montáž pružicích jednotek Mc-Pherson, jestliže ještě není k dispozici základní přístroj 4900-2 A		
	• 2dílná sada, obsah: • 4900-2 A základní přístroj stahováku pružin • 4903-1 základní nosník		
4903/2 A	2	180547	1744,-
	• Perfektní volba, pokud je k dispozici základní přístroj stahováku pružin 4900-2 A		
	• 3dílná sada, obsah: • 4903-1 základní nosník • 4903-2 univerzální upínací talíř, nastavitelný • 4903-3 univerzální upínací deska, nastavitelná, včetně bezpečnostního adaptéru		
4903/3	3	180554	3553,-
	• Perfektní kompletní balík		
	• 4dílný, obsah: • 4900-2 A základní přístroj stahováku pružin • 4903-1 základní nosník • 4903-2 univerzální upínací talíř, nastavitelný • 4903-3 univerzální upínací deska, nastavitelná, včetně bezpečnostního adaptéru		
4903/4	4	180561	3947,-
	• Univerzální upínací talíř, nastavitelný		
4903-2	–	179831	1415,-
	• Univerzální upínací deska, nastavitelná		
4903-3	–	179848	1418,-
	Základní přístroj bezpečnostního stahováku pružin		
	• Spirálová pružina při výměně tlumiče (povšimněte si přiřazovací tabulky stahováků pružin na internetu nebo v příručce nástrojů)		
4900-2 A	–	077267	952,-
	• Sada náhradních dílů pro univerzální stahovák pružin 4903-1 se skládá ze 2 válcových kolíků a 1 O-kroužku		
4903-01/3	–	181704	7,85
	• Brzda pro 4903-2		
4903-04	–	226351	140,50



Speciální nářadí

Podvozek – Stahovák pružin / tlumič



4910 Sada nářadí pro tlumiče pérování

Made in Germany



- Použití: Opravářské práce v oblasti pružící vzpěry, např. tlumiče, ložiska pružící vzpěry, spirálových pružin
- Protidržák pístnice při montáži a demontáži pružící jednotky
- **Pozor:** Dodržte hodnoty utahovacího momentu stanovené výrobcem vozidla
- Použití např. s momentovým klíčem např. HAZET 6291-1 CT ve spojení s nástrčným očkovým klíčem 6630 d-21
Při použití rázového utahováku hrozí poškození opěrného ložiska a pístnice
- Sada nářadí na tlumiče, obsah:
4910-1
4910-6 · 7 · 8
4910-16 · 17 · 18 · 19 · 21 · 22 · 24
4910-58 · 68



YouTube Clip



HAZET No.	$d \times \text{š} \times v$ mm		EAN-No. 4000896+	€
4910/13	355x235x65	13	061495	455,70

4910 Přepínací ráčna

Made in Germany



- Použití: Opravářské práce v oblasti pružící vzpěry, např. tlumiče, ložiska pružící vzpěry, spirálových pružin
- Přepínací ráčna
- Výstup dvojitý šestihran 21 mm



HAZET No.	l mm	EAN-No. 4000896+	€
4910-1	275	062133	81,40

4910 Nástrčná hlavice · šestihran

Made in Germany



- Použití: Opravářské práce v oblasti pružící vzpěry, např. tlumiče, ložiska pružící vzpěry, spirálových pružin
- Přidržení pístnice při montáži a demontáži pružící jednotky
- **Pozor:** Dodržte hodnoty utahovacího momentu stanovené výrobcem vozidla
- Pohon s 21 mm



HAZET No.	S mm	l mm	EAN-No. 4000896+	€
4910-16	16	82	062010	25,90
4910-17	17	82	062027	25,90
4910-18	18	82	062034	25,90
4910-19	19	82	062041	25,90
4910-21	21	82	062058	28,-
4910-22	22	82	062065	28,-
4910-24	24	82	062072	29,60

4910 Přidržený klíč pro pístnici

Made in Germany



- Použití: Opravářské práce v oblasti pružící vzpěry, např. tlumiče, ložiska pružící vzpěry, spirálových pružin
- Pohon s kuličkovou drážkou



HAZET No.	S mm	l mm	EAN-No. 4000896+	€
• Např. u BMW řada 1 F20 · F21 r. v. 2011 → řada 2 F22 · F23 · F45 · F46 r. v. 2013 → řada 3 F30 · F31 · F34 · F35 r. v. 2011 → řada 4 F32 · F33 · F36 r. v. 2013 → X1 F48 · F49 r. v. 2015				
4910-5	5	122,5	214549	22,95
4910-6	6	122,5	062089	22,95
4910-7	7	122,5	062096	22,95
4910-8	8	122,5	062102	22,95

Made in Germany



- Použití: Opravářské práce v oblasti pružící vzpěry, např. tlumiče, ložiska pružící vzpěry, spirálových pružin
- Pohon s kuličkovou drážkou



HAZET No.	S mm	l mm	EAN-No. 4000896+	€
4910-58	5x8	122,5	062119	31,85
4910-68	6x8	122,5	062126	31,85
• Pro PORSCHE Cayenne S · VW Touareg · Touran · Sharan				
4910-71	7,1x9,6	122,5	091195	31,85

Made in Germany



- Použití: Opravářské práce v oblasti pružící vzpěry, např. tlumiče, ložiska pružící vzpěry, spirálových pružin
- Pohon s kuličkovou drážkou
- Pro OPEL Astra H · MERCEDES-BENZ třída C (204) · třída E (212) · třída E Coupé (207)



HAZET No.	l mm	EAN-No. 4000896+	€
4910-T 50	122,5	120598	31,90

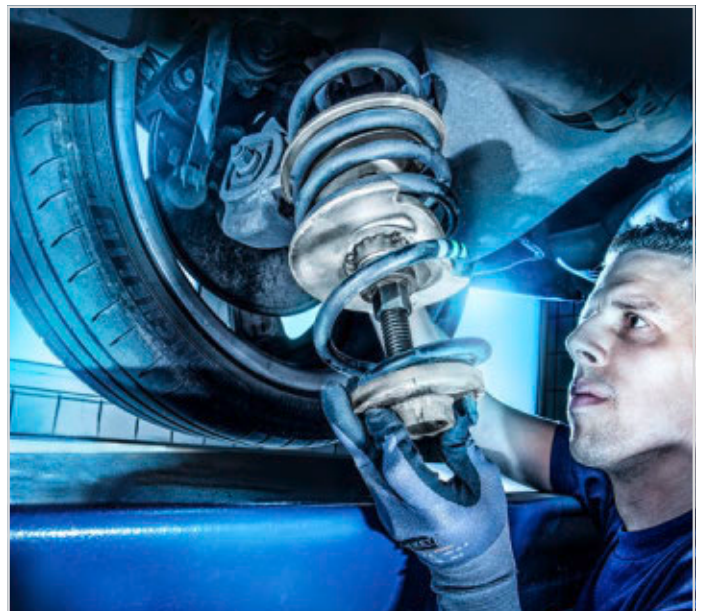



4915 Sada nářadí pro tlumiče pérování

- Použití: Pro opravářské práce v oblasti pružící vzpěry, např. tlumiče, ložiska pružící vzpěry, spirálových pružin
 - Přidržení písnice při montáži a demontáži pružící jednotky
 - **Pozor:** Dodržte hodnoty utahovacího momentu stanovené výrobcem vozidla – Nástavec s momentovým klíčem např. HAZET 6291-1 CT ve spojení s nástrčným očkovým klíčem 6630 d-21
- Při použití rázového utahováku může dojít k poškození opěrného ložiska a písnice

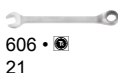
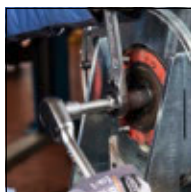

606 • 21
4910 • 16 • 17 • 18 • 19
21 • 22 • 24

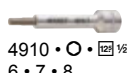

4910 • 6 • 7 • 8
4910 • 5 x 8 • 6 x 8
7,1 x 9,6

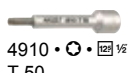

4910 • T 50

HAZET No.	$d \times \bar{s} \times v$ mm		EAN-No. 4000896+	€
4915/15	355x235x65	15	179213	358,30

2593 Čepový klíč na tlumiče

Made in Germany

- Použití: Manipulace se šroubením tlumiče pérování (opravy) u vozidel **VW, SEAT a AUDI** (přední náprava)
- Pohon 22 mm, b = šířka čepu
- Povrch: chromováno

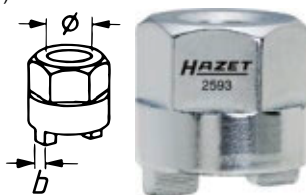

HAZET No.	mm	mm	b mm	EAN-No. 4000896+	€
2593-4	22	14,5	5	017263	17,80

2780 Čepový klíč na tlumiče

Made in Germany

- Použití: Manipulace se šroubením tlumiče pérování (horní čepové šroubení) u **MERCEDES-BENZ** typ 203 (třída C od 2000)
- Pohon 22 mm, b = šířka čepu
- Povrch: chromováno

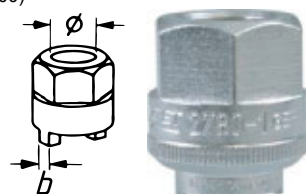

HAZET No.	mm	mm	b mm	EAN-No. 4000896+	€
2780-1	22	14,1	2,6	082858	23,65

2710 Speciální nástroj na nastavení odklonu

Made in Germany

- Speciální nástroj vyladěný na extrémně špatně přístupné šroubení tlumičů



- Použití: Šroubení tlumičů pro nastavení odklonu na vozech **MERCEDES-BENZ** Sprinter, **VW** Crafter
- Speciální nástroj umožňuje:
 - Ovládání i při nepříznivých prostorových poměrech na měřicí plošině
 - Potřebné přivádění síly k manipulaci se šroubením



HAZET No.	EAN-No. 4000896+	€
2710-21	206414	56,20

Ložisko kola / náboj kola

1779 Stahovák kulových kloubů

Made in Germany

- Použití: Vytlačení čepů kulových kloubů na spojovacích tyčích řízení, stabilizátorech atd.
- a = rozevření klíče
- Povrch: zinkováno

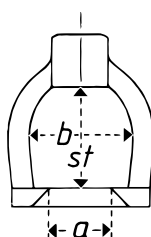

HAZET No.	a mm	b mm	st mm	EAN-No. 4000896+	€
1779-18	18	40	33	136001	45,90
1779-23	23	50	42	136018	55,60
1779-27	27	54	54	136025	71,30
1779-37	37	75	77	136032	109,80
1779-55	55	81,3	80	136407	170,90

1779 Univerzální stahovák kulových kloubů

Made in Germany

- Použití: Vytlačení čepů kulových kloubů (rozevření klíče 23 mm) na pákách řízení, tyčích řízení, stabilizátorech atd. u nejběžnějších značek vozidel
- Velký rozsah upnutí díky plynulému přestavení výšky a otáčení spodního dílu

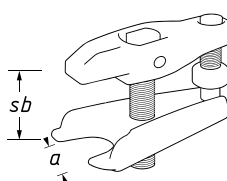

HAZET No.	a mm	sb mm	EAN-No. 4000896+	€
1779-1	23	65	135974	79,30



1779 Univerzální stahovák kulových kloubů

Made in Germany

• Stabilní provedení a hluboká upínací drážka umožňují bezpečné univerzální použití, např. u UV lehké konstrukce

- Použití: Vytlačení čepů kulových kloubů na řídicích pákách, spojovacích tyčích řízení, stabilizátorech atd.
- Pro nejběžnější značky vozidel

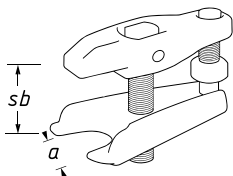

HAZET No.	a mm	sb mm	EAN-No. 4000896+	€
1779-3	32	85	135998	195,10

1779 Stahovák kulových kloubů

Made in Germany

• Použití: Vytlačení čepů kulových kloubů u řídicích pák, spojovacích tyčí, nápravových čepů, stabilizátorů atd.

- Rozsah upnutí 50–80 mm
- Hloubka vidlice 35 mm

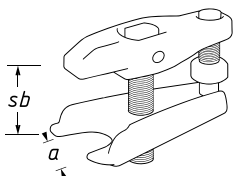

HAZET No.	a mm	sb mm	EAN-No. 4000896+	€
1779-22	20	50–80	141654	162,40

1790 Stahovák kulových kloubů

Made in Germany

• Použití: Vytlačení čepů kulových kloubů zejména u vozidel s nápravou s prostorově uloženými rameny

- např. AUDI A6 a A8, VW Passat, Golf
- Povrch: pozinkováno, pasivováno (bez Cr6)

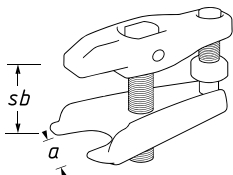

HAZET No.	a mm	sb mm	EAN-No. 4000896+	€
1790-4	30	65	145447	224,50

1790 Univerzální stahovák kulových kloubů

Made in Germany

• Použití: Vytlačení čepů kulových kloubů na tyčích řízení, stabilizátorech atd.

Pro FORD, BMW, Volvo, TOYOTA, OPEL, VW, AUDI, RENAULT

- Rozevření klíče 20 mm
- Rozsah upnutí (sb) 2stupňový
stupeň 1: do 30 mm
stupeň 2: do 50 mm



1790 Univerzální stahovák kulových kloubů

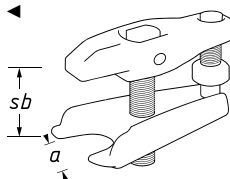

HAZET No.	a mm	sb mm	EAN-No. 4000896+	€
1790-7	20	12–50	148073	129,40

1790 Stahovák kulových kloubů

Made in Germany

• S hydraulickou podpěrou

• Použití: Silu šetřící vytlačení čepů kulových kloubů a bezpečné vymontování kulových kloubů

- Povrch: zinkováno, žluté pasivováno (bez Cr6)
- Pro osobní automobily · dodávky · užitková vozidla
- Zatížení maximálně 12 tun

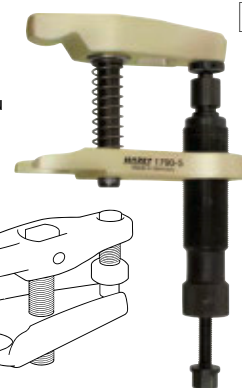
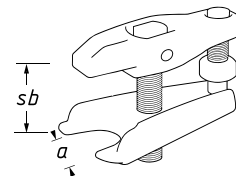

HAZET No.	a mm	sb mm	EAN-No. 4000896+	€
1790-5	32	70	145461	366,90

1780 Dělicí a stahovací vidlice

Made in Germany

• Osvědčený a cenově výhodný systém

• Použití: Rychlé ovládání hlav hlavní tyče řízení a spojovací tyče řízení, hlavních pák řízení a ostatních řídicích dílů díky klínové vidlici

- Jednoduchá manipulace
- Demontáž tlumičů a jiné oddělovací práce
- Oddělovací vidlici lze použít i v nejtěsnějších prostorech
- Robustní, kované provedení

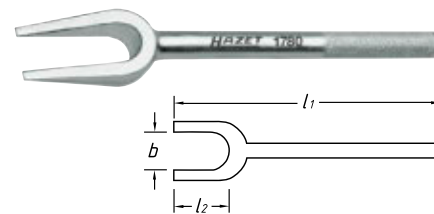

HAZET No.	l ₁ mm	l ₂ mm	b mm	EAN-No. 4000896+	€
1780-18	340	80	18	133345	51,95
1780-23	340	80	23	133352	55,70
1780-29	350	80	29	133376	58,15

1781 Univerzální stahovák nábojů kol

Made in Germany

• Posouvateľné a vyměnitelné stahovací háky

- S 5 stahovacími háky
- Povrch: zinkováno



HAZET No.	Max. t	sb mm	Vřeteno	EAN-No. 4000896+	€
1781-5	10	115–225	G 3/4"x200 mm	136049	283,60



2583 Nářadí pro ložiska kol

Made in Germany

- Pro nastavení otočné tyče
– Demontáž ložisek kol u Transportéru T4
- Dlouhé provedení
- S rýhováním
- Povrch: matně chromováno
- DIN 3124, ISO 2725-1



HAZET No.	S mm	l mm	EAN-No. 4000896+	€
2583	27	140	017034	53,50

4912 Rozpínací přípravek na pouzdra ložiska kola

Made in Germany

- Použití: Rozšiřování uložení pružic vzpěry a nosného kloubu (k oddělení pružic vzpěry od tělesa ložiska kola)
- Pohon s kulíčkovou drážkou

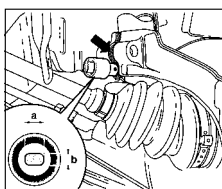

360°



HAZET No.	S mm	l ₁ mm	l ₂ mm	EAN-No. 4000896+	€
• Použití např. u vozidel VW Fox r.v. 2005 → · Polo r.v. 2002 → · New Beetle · Golf r.v. 1998 → 2004 · Tiguan r.v. 2008 → · Eos r.v. 2006 → · Passat r.v. 2006 → · Touran r.v. 2003 → · Caddy r.v. 2004 → · T5 r.v. 2004 → • AUDI A2 r.v. 2001 → · A3 r.v. 2004 → · A4 r.v. 2001 → 2008 · A5 r.v. 2008 → · A6 r.v. 2008 → · TT r.v. 2007 → • SEAT · ŠKODA • ⌀ 5,5x8 mm 4912-1 ⌀ 5,5x8 mm 10 48 156368 10,35					
• Použití např. u RENAULT · PEUGEOT · CITROËN · VW Golf 7 · SEAT León 3 • ⌀ 5x7 mm 4912-2 ⌀ 5x7 mm 10 49 155804 10,35					
• Použití např. u BMW · MINI • ⌀ 6x8 mm 4912-3 ⌀ 6x8 mm 10 49 217427 10,70					
• Použití např. u MERCEDES-BENZ Sprinter, typ 910 s předním pohonem r. v. 2018 → • ⌀ 7,8x11 mm 4912-4 ⌀ 7,8x11 mm 10 50 222551 11,70					

4912 Sada pro nastavení odklonu

• Vhodné pro VW Golf, Jetta, SEAT Toledo atd.



- Nastavení odklonu s jednou osobou
- Značné snížení potřebného času
- Stabilní 6hran. vřeteno s s 22 mm pro jednoduchou manipulaci
- Upínací šifka: 135 – 175 mm



HAZET No.	€
4912-3/2	168,90

4930 Sada nářadí pro ložiska kol

Made in Germany

- Sada nářadí pro ložiska kol pro mechanickou a hydraulickou manipulaci
- Hydraulický ve spojení s válcem s dutým pístem 4932-17 a závitovým vřetenem 4932-TR 20
- Plastová skříňka
- Vložka z měkké pěny, rozšiřitelná
- Sada nářadí na silentbloky, obsah:
4930-1 · 2 · 3 · 4 · 5 · 7
4930-721 · 821 · 851
4930-34x40 · 39x41 · 35x42 · 37x45
4930-62 · 64 · 66 · 68 · 72 · 74 · 80 · 82 · 84



YouTube Clip

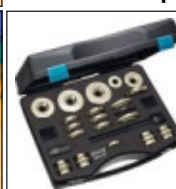

HAZET No.	€
4930-1/22	1261,-

4930 Závitové vřeteno

Made in Germany

- TR20x2
- Včetně axiálních ložisek
- Pohon šestihran s 22
- Nosnost maximálně 12 tun .



HAZET No.	l mm	EAN-No. 4000896+	€
4930-1	270	080755	181,90

4930 Matice vřetena

Made in Germany

- Pohon šestihran s 30



HAZET No.	€
4930-2	28,55



Speciální nářadí

Podvozek – Ložisko kola / náboj kola



4930 Distanční podložka

Made in Germany



HAZET No.	EAN-No. 4000896+	€
4930-3	081158	24,20
4930-4	081141	21,90
4930-5	082834	14,85

4930 Redukční kroužek

Made in Germany



HAZET No.	EAN-No. 4000896+	€
• Pro VW Polo C a PEUGEOT 106 • Ve spojení s tělesem 4930-721	083633	36,10
• Ve spojení s tělesem 4930-851	083640	40,30
• Vnitřní Ø 45 mm ve spojení s 4930-8245	097890	13,65

4930 Středící kotouč

Made in Germany

• Vtažení nového ložiska kol na AUDI A4 · A6



HAZET No.	EAN-No. 4000896+	€
4930-9	121465	68,80

4930 Středící pouzdro

Made in Germany



HAZET No.	EAN-No. 4000896+	€
• Pro vnitřní Ø ložiska 34 / 40 mm	081042	50,10
• Pro vnitřní Ø ložiska 35 / 40 mm	081066	50,10
• Pro vnitřní Ø ložiska 35 / 42 mm	081035	50,10
• Pro vnitřní Ø ložiska 37 / 45 mm	081073	50,10

4930 Středící pouzdro



HAZET No.	EAN-No. 4000896+	€
• Pro vnitřní Ø ložiska 39 / 41 mm	081028	51,90
• Pro vnitřní Ø ložiska 43 / 45 mm	097739	50,10

4930 Tlačná podložka

Made in Germany



HAZET No.	EAN-No. 4000896+	€
• Pro vnější Ø ložiska 62 – 64 mm	080854	40,90
• Pro vnější Ø ložiska 64 – 66 mm	080939	40,90
• Pro vnější Ø ložiska 66 – 68 mm	080946	40,90
• Pro vnější Ø ložiska 68 – 70 mm	080953	42,65
• Pro vnější Ø ložiska 72 – 74 mm	080960	42,70
• Pro vnější Ø ložiska 74 – 76 mm	080977	42,70
• Pro vnější Ø ložiska 80 – 82 mm	081004	46,15
• Pro vnější Ø ložiska 82 – 84 mm	080991	44,55
• Ve spojení s 4930-8 vnitřní Ø 45 mm	097746	44,55
• Pro vnější Ø ložiska 82 mm	097746	44,55
• Pro vnější Ø ložiska 84 – 85 mm	081448	44,55

4932 Válec s dutým pístem

Made in Germany



• Kompaktní 17t hydraulický válec

- Provozní tlak: maximálně 700 bar
- Komfortní vrácení pružinou
- Pro závitové vřeteno 4932-TR 20 a matici 4930-2
- Tažná strana se závitem: M27 x2, alternativně možný M42 x2 přes volitelný adaptér
- Tlačná strana se závitem: 2.1/4" – 14 UNS
Vnitřní závit: TR 20 alternativně možný M20 přes volitelný adaptér
- Zdvih: 45 mm
- Vnější Ø: 80 mm
- Výška zajištěného válce: 206 mm / vyjetého: 251 mm
- Včetně spojky, krytky a adaptéru 4932-M 20
- Hmotnost: 5,5 kg



4934-7



HAZET No.	EAN-No. 4000896+	€
4932-17	159741	1143,-



4932 Závité vřeteno

Made in Germany

- Závité vřeteno s ocelovým lanem TR 20 (pro válec s dutým pístem 4932-17 a maticí 4930-2)



HAZET No.	l mm	EAN-No. 4000896+	€
4932-TR 20	546	159765	164,10

4934 Tlačná deska

Made in Germany

- Ve spojení s válcem s dutým pístem 4932-17
- Připevnění přípravku na ochranu proti skřípnutí 4934-7
- Závit vnitřní: M 27 x 2



HAZET No.	Ø mm	EAN-No. 4000896+	€
• Tlačná deska hydrauliky pro 4934-2572/12, -2562/6, -2566/6 při použití 4932-17			
4934-10	122	159932	144,80
• Tlačná deska hydrauliky pro 4934-2585/12 při použití 4932-17			
4934-8510	137	159628	150,-

4930 Pouzdro

Made in Germany

- Závit vnitřní: M 27 x 2



HAZET No.	EAN-No. 4000896+	€
• Pouzdro Ø 72 mm pro skupinu nářadí 4930 při použití 4932-17 s 4932-TR 20 a 4930-2		
4930-721	159598	108,90
• Pouzdro Ø 82 mm pro skupinu nářadí 4930 při použití 4932-17 s 4932-TR 20 a 4930-2		
4930-821	159604	127,60
• Pouzdro Ø 85 mm pro skupinu nářadí 4930 při použití 4932-17 s 4932-TR 20 a 4930-2		
4930-851	159611	142,30

4932 Adaptér pro válec s dutým pístem 4932-17

Made in Germany



HAZET No.	EAN-No. 4000896+	€
• Adaptér pro závité vřeteno se závitom M 20		
• Zvyšuje kompatibilitu válce s dutým pístem HAZET s dalšími závítovými vřeteny a speciálním nářadím		
• Vhodné také pro použití nářadí jiných výrobců		
4932-M 20	165681	24,05

4932 Adaptér pro válec s dutým pístem 4932-17

HAZET No.	EAN-No. 4000896+	€
• Adaptér pro válec s dutým pístem Klann KL-0040-2500		
• Připojovací závit pro pouzdro HAZET 4930-721 · -821 · -851 a přítláčné desky 4934-10 · -8510 · -7801		
• Připojovací závit: M27 x 2		
• Vnější Ø: 80 mm		
4932-M 27 x 2	160037	40,70
• Adaptér pro válec s dutým pístem HAZET 4932-17		
• Adaptér s připojovacím závitom pro poháněcí nářadí firmy Klann		
• Připojovací závit: M42 x 2		
• Vnější Ø: 80 mm		
• Umožňuje použití válce s dutým pístem HAZET 4932-17 pro práci s manipulačním nářadím firmy Klann, mj. sady nářadí pro ložiska kol / silentbloky		
4932-M 42 x 2	183432	45,-

4932 Pneumaticko-hydraulické čerpadlo

Made in Germany

- Včetně manometru a 1,8metrové hydraulické hadice s připojovací spojkou
- Provozní tlak: maximálně 700 bar
- Závit vzduchové přípojky: 12,91 mm (1/4")
- Hydraulická přípojka: 16,41 mm (3/8") – 18 NPTF
- Velký ovládací pedál: pumpuje, drží, odpouští
- Nádř z ocelového plechu
- Množství náplně: 1500 cm³
- Užité množství: 1000 cm³
- Rozměry: 260 x 140 x 186 mm



HAZET No.	EAN-No. 4000896+	€
4932 N-110	187393	1492,-

4931 Sada pro stažení vnitřního kroužku ložiska

Made in Germany

- Pro vnitřní kroužky ložisek, které přiléhají přímo k náboji kola
- Použití: Stahování vnitřních kroužků ložisek při demontáži ložiska kola na náboji kola
- S vyšším stahovacím momentem vzrůstá síla upínacích kleští. Díky tomu optimální ochrana před sklouznutím z ložiskového kroužku
- I pro modely s ABS kroužkem (zejména pro pevné spojená provedení)
- Pro AUDI · BMW · FORD · MERCEDES-BENZ · PEUGEOT · RENAULT · TOYOTA · VW
- Vřeteno a pohybový závit umožňují vysoké stahovací síly
- Momentové rameno pro uchycení celé jednotky do svěráku pro optimální práci
- 4 upínací kleštiny (40 až 45 mm / 45 až 50 mm / 50 až 55 mm / 55 až 61 mm) pokrývají všechny průměry od 40 do 61 mm
- Podrobný návod k obsluze s obrázky
- Plastová skříňka
- Vložka z měkké pěny



HAZET No.	EAN-No. 4000896+	€
4931-1/8	155538	859,-



Speciální nářadí

Podvozek – Ložisko kola / náboj kola



4934 Sada nářadí pro kompaktní ložiska kol

Made in Germany

- Použití: Demontáž a montáž ložiskové jednotky nábojů kol v namontovaném stavu
- HAZET doporučuje ložiska kol NTN-SNR
- Plastová skříňka
- Vložka z měkké pěny, rozšiřitelná

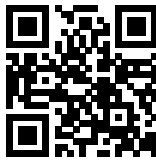

YouTube Clip

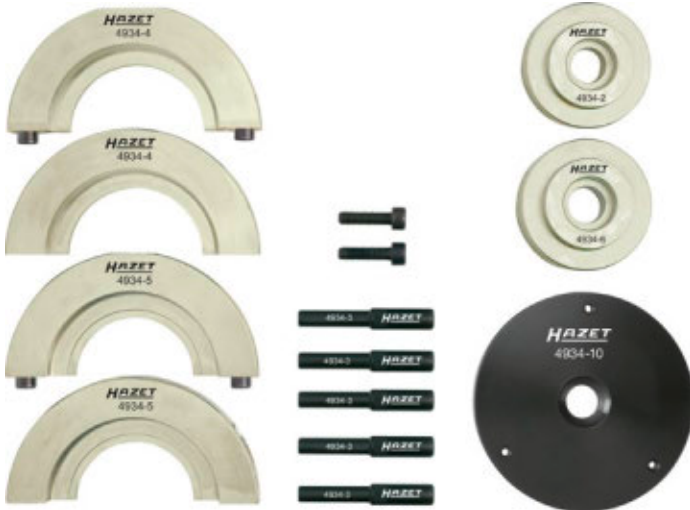

4934-5/3



4934 Sada nářadí pro kompaktní ložiska kol

Made in Germany

- Použití: Demontáž a montáž ložiskové jednotky nábojů kol v namontovaném stavu
- HAZET doporučuje ložiska kol NTN-SNR



4934-6205/3



HAZET No.		EAN-No.	€
• Základní sada (72 mm Ø)			
Předpoklad použití: závitové vřeteno 4930-1 a matice vřetene 4930-2			
Použití:			
typy vozidel s ložisky kol Ø 72 mm: AUDI A1 r. v. 2011 → A2 r. v. 2000 → ŠKODA Fabia r. v. 2000 → Roomster r. v. 2006 → VW Polo r. v. 2002 → Polo (6R) · Fox r. v. 2005 → SEAT Ibiza r. v. 2002 →			
• Návod s 3-D ilustracemi			
• 12dílná sada , obsah: tlačná deska 4934-10, tlačná podložka 4934-7802, tlačné čepy 4934-3 (5x), opěrný kroužek 4934-4, opěrný kroužek 4934-5, tlačná podložka 4934-6, 2 válcové šrouby			
4934-2572/12	12	150410	790,-
• Jednotlivé díly (montáž)			
• Opěrný kroužek 4934-5, 2 válcové šrouby			
4934-5/3	3	150335	212,80

HAZET No.		EAN-No.	€
Doplňková sada (62 mm Ø)			
Použití:			
typy vozidel s ložisky kol Ø 62 mm: VW Lupo · AUDI A2 1,2 I (Předpoklad použití: závitové vřeteno 4930-1 · vřeténová matice 4930-2 · a sada 4934-2572/12)			
• 6dílná sada , obsah: tlačná podložka 4934-6202 · tlačná podložka 4934-6206 · opěrný kroužek 4934-6204 · opěrný kroužek 4934-6205 · 2 válcové šrouby			
4934-2562/6	6	150403	494,50
• Jednotlivé díly (montáž)			
• Opěrný kroužek 4934-6205, 2 válcové šrouby			
4934-6205/3	3	150373	224,-





4934 Sada nářadí pro kompaktní ložiska kol

Made in Germany

- Použití: Demontáž a montáž ložiskové jednotky nábojů kol v namontovaném stavu
- HAZET doporučuje ložiska kol NTN-SNR



4934-6605/3



HAZET No.

EAN-No. 4000896+

€

Doplňková sada (66 mm Ø)

Použití:

typy vozidel s ložisky kol Ø 66 mm:

VW Polo · ŠKODA Fabia

Předpoklad použití: závitové vřeteno 4930-1, vřetenová matice 4930-2, a sada 4934-2572/12

• 6dílná sada, obsah:

tlačná podložka 4934-6202, tlačná podložka 4934-6206, opěrný kroužek 4934-6604, opěrný kroužek 4934-6605, 2 válcové šrouby

4934-2566/6 6 150427 494,50

• Jednotlivé díly (montáž)

• Opěrný kroužek 4934-6605, 2 válcové šrouby

4934-6605/3 3 150342 224,-

Made in Germany

- Použití: Demontáž a montáž ložiskové jednotky nábojů kol v namontovaném stavu
- HAZET doporučuje ložiska kol NTN-SNR
- Plastová skříňka
- Vložka z měkké pěny, rozšiřitelná

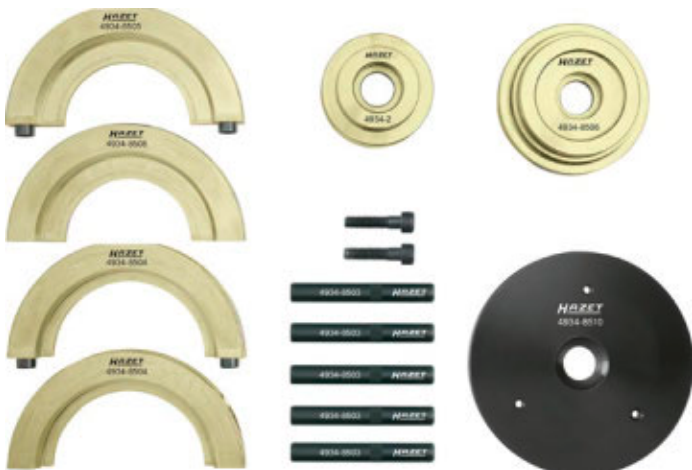

4934 Sada nářadí pro kompaktní ložiska kol



4934-8505/3

HAZET No.

EAN-No. 4000896+

€

Speciální sada (85 mm Ø)

Použití:

typy vozidel s ložisky kol Ø 85 mm:

VW T5 · T6 (přední a zadní náprava – zadní náprava jen ve spojení s 4934-8507)

a Touareg s 16palcovým podvozkem

Předpoklad pro použití: závitové vřeteno 4930-1, vřetenová matice 4930-2

• Návod s 3-D ilustracemi

• 12dílná sada, obsah:

tlačná deska 4934-8510, tlačná podložka 4934-7802, tlačná podložka 4934-8506, tlačné čepy 4934-8503 (5x) opěrný kroužek 4934-8504, opěrný kroužek 4934-8505, 2 válcové šrouby

4934-2585/12 12 150434 789,-

• Jednotlivé díly (montáž)

• Opěrný kroužek 4934-8505, 2 válcové šrouby

4934-8505/3 3 150380 209,20

4934 Adaptérový kroužek VW T5

Made in Germany



- Montáž jednotky náboje kol / kolového ložiska na **zadní nápravě VW T5 · T6**
- Doplnění sady nářadí pro kompaktní ložiska kol 4934-2585/12
- Speciálně ve spojení s tlačnou podložkou 4934-8506



HAZET No.

EAN-No. 4000896+

€

4934-8507

154913

55,35

4934 Ochrana proti skřípnutí

Made in Germany



HAZET No.

EAN-No. 4000896+

€

• Pro hydraulické ovládání speciálního nářadí HAZET 4934-10 a 4934-8510

• Sestává z montážního kroužku s plastovým pouzdem

3 upevňovacích šroubů a přídavného pouzdra

4934-7 164783 200,-



Speciální nářadí

Podvozek – Ložisko kola / náboj kola



Příklady přiřazení:

Další informace najdete také na internetu na webové stránce www.hazet.de → Poradce pro použití → Přiřazení ložisek kol



Technické změny výrobců vozidel vyhrazeny

 Typ	 Rok montáže ložiska	Poznámka	Pozice	 Ložisko	Sada HAZET na ložiska kol	NTN-SNR reference sada ložisek kol
AUDI						
A1	5/2010		Přední náprava	72 mm	4934-2572/12 & 4930-1 & 4930-2	R157.32
A2 1.4 i/1.6 FSI/1.4 Tdi (AU24)	6/2000	S ABS	Přední náprava	72 mm	4934-2572/12 & 4930-1 & 4930-2	R157.32
A2 1.2 TDi (AU24)	3/2001		Přední náprava	62 mm	4934-2562/6 & 4930-1 & 4930-2 & 4934-2572/12	R154.52
SEAT						
Córdoba 4	9/2002 → 6/2005		Přední náprava	72 mm	4934-2572/12 & 4930-1 & 4930-2	R157.32
Córdoba 4 1.2 i/1.4 i/1.4 TDi/1.6 i/1.9 SDi/1.9 TDi	6/2005		Přední náprava	66 mm	4934-2566/6 & 4930-1 & 4930-2 & 4934-2572/12	R157.49
Córdoba 4 1.9 TDi 131PS (Motor ALZ,BLT)	6/2005		Přední náprava	72 mm	4934-2572/12 & 4930-1 & 4930-2	R157.32
Córdoba 4 2.0 i	6/2005		Přední náprava	72 mm	4934-2572/12 & 4930-1 & 4930-2	R157.32
Ibiza 3	9/2001 → 6/2005	Č. podvozku – 6L-6-000001	Přední náprava	72 mm	4934-2572/12 & 4930-1 & 4930-2	R157.32
Ibiza 3 1.2 12V/1.4 16V/1.4 TDi/1.6/1.9SDi	6/2005 → 11/2009		Přední náprava	66 mm	4934-2566/6 & 4930-1 & 4930-2 & 4934-2572/12	R157.49
Ibiza 3 1.9 TDi 100PS (motor ATD)	5/2004 → 11/2009		Přední náprava	66 mm	4934-2566/6 & 4930-1 & 4930-2 & 4934-2572/12	R157.49
Ibiza 3 1.9 TDi 130PS (motor ASZ)	6/2005 → 11/2009		Přední náprava	72 mm	4934-2572/12 & 4930-1 & 4930-2	R157.32
Ibiza 3 1.9 TDi Cupra 160PS (motor BPX)	6/2005 → 11/2009		Přední náprava	72 mm	4934-2572/12 & 4930-1 & 4930-2	R157.32
Ibiza 3 2.0i/1.8 20V	6/2005 → 11/2009		Přední náprava	72 mm	4934-2572/12 & 4930-1 & 4930-2	R157.32
Ibiza 4	3/2008		Přední náprava	72 mm	4934-2572/12 & 4930-1 & 4930-2	R157.32
ŠKODA						
Fabia (6Y)	8/1999 → 7/2004	S posilovačem řízení	Přední náprava	72 mm	4934-2572/12 & 4930-1 & 4930-2	R157.32
Fabia (6Y) [CZ]	8/1999 → 7/2002	Bez posilovače řízení / plechová matice č. podvozku – 6Y-2-366084	Přední náprava	66 mm	4934-2566/6 & 4930-1 & 4930-2 & 4934-2572/12	R178.05
Fabia (6Y) [CZ]	7/2002 → 7/2004	Bez posilovače řízení / dvanáctihranná matice / č. podvozku 6Y-3-366085 -	Přední náprava	66 mm	4934-2566/6 & 4930-1 & 4930-2 & 4934-2572/12	R157.49
Fabia (6Y) [PL]	8/1999 → 9/2002	Bez posilovače řízení / plechová matice č. podvozku – 6Y-2X-028027	Přední náprava	66 mm	4934-2566/6 & 4930-1 & 4930-2 & 4934-2572/12	R178.05
Fabia (6Y) [PL]	9/2002 → 7/2004	Bez posilovače řízení / dvanáctihranná matice / č. podvozku 6Y-2X-028028 -	Přední náprava	66 mm	4934-2566/6 & 4930-1 & 4930-2 & 4934-2572/12	R157.49
Fabia Facelift (6Y)	8/2004 → 12/2007	S posilovačem řízení / s ABS / disky 14 palců	Přední náprava	72 mm	4934-2572/12 & 4930-1 & 4930-2	R157.32
Fabia Facelift (6Y)	8/2004 → 12/2007	Bez posilovače řízení	Přední náprava	66 mm	4934-2566/6 & 4930-1 & 4930-2 & 4934-2572/12	R157.49
Fabia 2 (5J)	12/2006	S ABS	Přední náprava	72 mm	4934-2572/12 & 4930-1 & 4930-2	R157.32
Fabia 2 Facelift	3/2010	Brzdové kotouče 256 mm	Přední náprava	72 mm	4934-2572/12 & 4930-1 & 4930-2	R157.32



Typ	Rok montáže ložiska	Poznámka	Pozice	Ložisko	Sada HAZET na ložiska kol	NTN-SNR reference sada ložisek kol
ŠKODA						
Roomster	3/2006 → 3/2010	S ABS	Přední náprava	72 mm	4934-2572/12 & 4930-1 & 4930-2	R157.32
Roomster Facelift 1.2 i/1.4 i/1.4 TDi/1.6 i/1.9 TDi	3/2010	Brzdové kotouče 256 mm	Přední náprava	72 mm	4934-2572/12 & 4930-1 & 4930-2	R157.32
VOLKSWAGEN						
Fox 1.2 i	11/2004	S ABS / brzdové kotouče 239 mm	Přední náprava	66 mm	4934-2566/6 & 4930-1 & 4930-2 & 4934-2572/12	R157.49
Fox 1.2 i	11/2004	Brzdové kotouče 256 mm	Přední náprava	72 mm	4934-2572/12 & 4930-1 & 4930-2	R157.32
Fox 1.4 i	11/2004	S ABS	Přední náprava	72 mm	4934-2572/12 & 4930-1 & 4930-2	R157.32
Fox 1.4 TDi	11/2004	S ABS	Přední náprava	72 mm	4934-2572/12 & 4930-1 & 4930-2	R157.32
Lupo 1.2 TDi	5/1999 → 7/2005		Přední náprava	62 mm	4934-2562/6 & 4930-1 & 4930-2 & 4934-2572/12	R154.52
Polo 7 (9N) 1.2 i / 1.4 / 1.4FSi / 1.6	1/2002 → 10/2003	Bez posilovače řízení	Přední náprava	66 mm	4934-2566/6 & 4930-1 & 4930-2 & 4934-2572/12	R157.49
Polo 7 (9N) 1.2 i / 1.4 / 1.4FSi / 1.6	11/2003 → 7/2004	S posilovačem řízení	Přední náprava	72 mm	4934-2572/12 & 4930-1 & 4930-2	R157.32
Polo 7 (9N) 1.4 Tdi/1.9 Sdi/1.9 Tdi	11/2001 → 5/2005		Přední náprava	72 mm	4934-2572/12 & 4930-1 & 4930-2	R157.32
Polo 8 (9N) 1.2 i/1.4 i/1.4 FSi/1.4 16V/ 1.6	4/2005 → 7/2007	Bez posilovače řízení	Přední náprava	66 mm	4934-2566/6 & 4930-1 & 4930-2 & 4934-2572/12	R157.49
Polo 8 (9N) 1.2 i/1.4 i/1.4 FSi/1.4 16V/ 1.6	4/2005 → 8/2007	S posilovačem řízení	Přední náprava	72 mm	4934-2572/12 & 4930-1 & 4930-2	R157.32
Polo 8 (9N) 1.4 TDi/1.9 SDi/1.9 TDi	4/2005 → 8/2007		Přední náprava	72 mm	4934-2572/12 & 4930-1 & 4930-2	R157.32
Touareg 1 2.5 TDi	1/2003 → 10/2003		Přední náprava	85 mm	4934-2585/12 & 4930-1 & 4930-2	R154.58
Touareg 1 2.5 TDi	10/2003 → 11/2006		Přední náprava	85 mm	4934-2585/12 & 4930-1 & 4930-2	R154.62
Touareg 1	11/2002 → 11/2006	Disky 16 palců / č. podvozku – 4 035 000	Zadní náprava	85 mm	4934-2585/12 & 4930-1 & 4930-2	R154.58
Touareg 1	11/2002 → 11/2006	Disky 16 palců / č. podvozku 4 035 001 –	Zadní náprava	85 mm	4934-2585/12 & 4930-1 & 4930-2	R154.62
Touareg 1 FL	12/2006 → 5/2010	Disky 16 palců	Zadní náprava	85 mm	4934-2585/12 & 4930-1 & 4930-2	R154.62
Transporter 7E/7F (T5)	9/2009		Přední náprava	85 mm	4934-2585/12 & 4930-1 & 4930-2	R154.62
Transporter 7E/7F (T5)	9/2009		Zadní náprava	85 mm	4934-8507 & 4930-1 & 4930-2 & 4934-2585/12	R154.58
Transporter 7J/7H (T5)	4/2003 → 8/2003		Přední náprava	85 mm	4934-2585/12 & 4930-1 & 4930-2	R154.58
Transporter 7J/7H (T5)	8/2003 → 11/2009		Přední náprava	85 mm	4934-2585/12 & 4930-1 & 4930-2	R154.62
Transporter 7J/7H (T5)	8/2003 → 11/2009		Zadní náprava	85 mm	4934-8507 & 4930-1 & 4930-2 & 4934-2585/12	R154.58



Speciální nářadí

Podvozek – Ložisko kola / náboj kola



4935 Sada stahováků nábojů kol / kloubových hřídelí

Made in Germany

Při použití válce s dutým pístem HAZET 4932-17, který je k dostání jako volitelné příslušenství, nejsou ani extrémně zaseknuté díly problém

- Použití: Mechanické vytlačování kloubových hřídelí závitovým vřetenem HAZET 4935-44-M 20
- Vhodné pro: ALFA ROMEO · AUDI · BMW · CITROËN · FIAT · LADA · LANCIA · MERCEDES-BENZ · OPEL · PEUGEOT · RENAULT · SAAB · SEAT · VW atd.



HAZET No.		EAN-No. 4000896+	€
• Sada stahováků nábojů kol / kloubových hřídelí, obsah: 4935-40-M 12 · 4935-41-M 14 4935-44-M 20 · 4935-45-M 14 4935-42 · 4935-43			
4935-2/15	15	164479	678,-
• Tažný čep M 12 x 1,5 4935-40-M 12	-	166749	40,05
• Tažný čep M 14 x 1,5 4935-41-M 14	-	166732	40,05
• Adaptér 2.¼"-14UNS 4935-43	-	166664	95,15
• Šestihránná matice M 14 4935-45-M 14	-	165612	9,75
• Adaptérová deska Ø 160 mm, pro rozestup otvorů o Ø 90 až 130 mm 4935-42	-	166657	229,-
• Závitové vřeteno 230 mm dlouhé 4935-44-M 20	-	165629	114,60

4960 Bruska nábojů kol

Zabraňuje účinkům koroze a zkraslení utahovacího momentu kol

- Použití: Rychlé a snadné čištění kontaktních ploch od rzi a nečistot na nábojích kol a brzdových kotoučích s uchycením kolového šroubu
- Minimální tvorba prachu díky otevřeným pórům brusného materiálu a hrnčkovému tvaru brusného kotouče
- Bez tvorby jisker
- 10mm kolík s 3 kontaktními plochami pro uchycení např. do (pneumatické) vrtačky



4960 Bruska nábojů kol



HAZET No.	Ø mm		EAN-No. 4000896+	€
Pro náboje OA a dodávek do Ø 200 mm např. BMW · FIAT Ducato · MERCEDES-BENZ Sprinter atd.				
• Nízké opotřebení: asi 100 vozidel na kotouč				
• Otáčky maximálně 1000 1/min				
• 3dílná sada obsah: 1 brusný talíř, 2 brusné kotouče Ø 200 mm				
4960-200/3	200	3	143290	142,90
• Uchycení suchým zipem pro rychlou výměnu brusného kotouče				
• 2 náhradní brusné kotouče Ø 200 mm				
4960-0200/2	200	2	143306	93,45

4960 F Bruska nábojů kol

Zabraňuje účinkům koroze a zkraslení utahovacího momentu kol

- Použití: Optimální čištění plochy zařízení vnitřní strany přírub ráfků
- 11 mm vnější šestihran s 3 stykovými plochami k uchycení např. na pneumatické, akumulátorové a rovněž síťové připojené vrtačky
- Se středovým otvorovým vedením a integrovanou bruskou k čištění centrování kol
- Nízké opotřebení: asi 100 vozidel na kotouč
- Minimální tvorba prachu díky otevřeným pórům brusného materiálu a hrnčkovému tvaru brusného kotouče
- Bez tvorby jisker



HAZET No.		EAN-No. 4000896+	€
• Vnější průměr do 160 mm Ø			
• Pro průměr centrování kol: minimálně 51 mm			
• Otáčky maximálně 500 ot./min			
• 2dílná sada Obsah: 1 základní těleso 1 brusný kotouč Ø 160 mm			
4960 F-160/2	2	218387	84,40
• 3 náhradní brusné kotouče Ø 160 mm			
• Pro 4960 F-160/2			
• Uchycení suchým zipem pro rychlou výměnu brusného kotouče			
4960 F-0160/3	3	218806	115,10



4960 R Bruska nábojů kol

- Zabraňuje účinkům koroze a zkršení uťahovacího momentu kol

- Použití: Rychlé a snadné čištění kontaktních ploch od rzi a nečistot na nábojích kol a brzdových kotoučích s uchycením kolového šroubu
- **11 mm vnější šestihran s 3 stykovými plochami k uchycení např. na pneumatické, akumulátorové a rovněž síťově připojené vrtačky**
- Nízké opotřebení: asi 100 vozidel na kotouč
- Minimální tvorba prachu díky otevřeným pórům brusného materiálu a hrníčkovému tvaru brusného kotouče
- Bez tvorby jisker

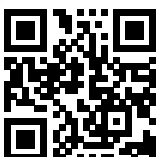

YouTube Clip

HAZET No.

EAN-No. 4000896+

€

- Pro náboj kol OA do 160 mm \varnothing
- Vnitřní průměr: 75 mm \varnothing
- Otáčky maximálně 500 ot./min
- **4dílná sada** obsah:
1 základní těleso
3 brusné kotouče \varnothing 160 mm

4960 R-160/4 4 218820 129,40

- **3 náhradní brusné kotouče \varnothing 160 mm**

- Pro 4960 R-160/4
- Uchycení suchým zipem pro rychlou výměnu brusného kotouče

4960 R-0160/3 3 218790 104,10

4960 V Bruska nábojů kol

- Zabraňuje účinkům koroze a zkršení uťahovacího momentu kol

- Použití: Rychlé a snadné čištění kontaktních ploch od rzi a nečistot na nábojích kol a brzdových kotoučích s uchycením kolového šroubu
- **S \square 12,5 mm ($\frac{1}{2}$ palcovým) vnitřním čtyřhranným uchycením k uchycení např. na pneumatické, akumulátorové a rovněž síťově připojené rázové uťahováký**
- Nízké opotřebení: asi 100 vozidel na kotouč
- Minimální tvorba prachu díky otevřeným pórům brusného materiálu a hrníčkovému tvaru brusného kotouče
- Bez tvorby jisker
- Rychlé a bezpečné použití brousícího nástroje díky suchému zipu a ozubení



YouTube Clip

4960 V Bruska nábojů kol



4960 V-0160/3

HAZET No.

EAN-No. 4000896+

€

- Pro náboj kol OA do 160 mm \varnothing
- Vnitřní průměr: 75 mm \varnothing
- Otáčky maximálně 500 ot./min
- **2dílná sada** obsah:
1 základní těleso
1 brusný kotouč \varnothing 160 mm

4960 V-160/2 2 218394 71,30

- **3 náhradní brusné kotouče \varnothing 160 mm**

- Pro 4960 V-160/2
- Uchycení suchým zipem pro rychlou výměnu brusného kotouče

4960 V-0160/3 3 218813 115,10

4961 N Bruska nábojů kol

Made in Germany

- Zabraňuje účinkům koroze a zkršení uťahovacího momentu kol

- Použití: Rychlé a snadné čištění kontaktních ploch od rzi a nečistot na nábojích kol a brzdových kotoučích s uchycením kolového šroubu
- Minimální tvorba prachu díky otevřeným pórům brusného materiálu a hrníčkovému tvaru brusného kotouče
- Bez tvorby jisker



4961 N
-023 M/5 -023 S/5

HAZET No.

EAN-No. 4000896+

€

- 6hran. uchycení pro pevné držení v přístroji
- Speciální bruska pro optimální čištění dosedacích ploch disků (náboje kol) pro NA a dodávky se šrouby v náboji kol
- **8hranný profil** pro bezpečné a pevné uchycení brusného kotouče do základního talíře
- Vnitřní \varnothing max.: 23 mm
- Brusné kotouče \varnothing 56 mm
- Made in Germany (hliníkové tělo unašeče)

- **12dílná sada**, obsah:
1 hliníkové základní tělo
5 brusných kotoučů pro střední znečištění
6 brusných kotoučů pro silné znečištění

4961 N-23/12 12 186754 192,50

- Uchycení suchým zipem pro rychlou výměnu brusného kotouče

- **5 náhradních brusných kotoučů pro střední znečištění**, vnější \varnothing 56 mm, vnitřní \varnothing maximálně 23 mm

4961 N-023 M/5 5 187270 56,40

- Uchycení suchým zipem pro rychlou výměnu brusného kotouče

- **5 náhradních brusných kotoučů pro silné znečištění**, vnější \varnothing 56 mm, vnitřní \varnothing maximálně 23 mm

4961 N-023 S/5 5 187287 76,40



Speciální nářadí

Podvozek – Silentblok



Silentblok

4925 Sada nářadí pro silentbloky

Made in Germany

• Pro VW, AUDI, SEAT, ŠKODA

- Použití: Vytahování a vtahování silentbloku v konzoli na příčném vodícím ramenu přední nápravy
- Práce v zabudovaném stavu
- Odpadá měření geometrie nápravy
- M 12x1,75

VW Polo 9N r.v. 2002 → 2009 · Fox r.v. 2005 →

AUDI A2 r.v. 2000 → 2005

ŠKODA Fabia r.v. 2000 → 2004

SEAT Ibiza · Altea · Córdoba

r.v. 2003 → 2005

• Sada nářadí na silentbloky, obsah:

4925-4 · 5 · 6 · 7 · 8 A

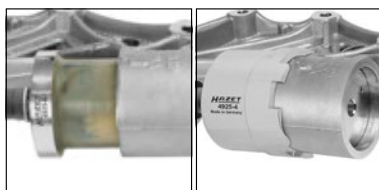

HAZET No.		EAN-No. 4000896+	€
4925-2501/5	5	159406	237,20

4925 Sada vřeten pro hydraulickou manipulaci

Made in Germany

• Pro sadu na silentbloky 4925-2504/9 a doplňkovou sadu 4925-2504/2

- Ve spojení s dutým pístovým válcem 4932-17 pro hydraulickou montáž a demontáž gumo-plastového silentbloku a gumo-kovového silentbloku na zadní nápravě VW Golf 4 · ŠKODA Octavia r. v. 1997 → · SEAT León · Toledo r. v. 2001 →

• Vřeteno M 12x1,5 zatížením maximálně 5 tun

• Sada vřeten pro hydraulické ovládání, obsah: 4925-27 · 29 (2x)



HAZET No.	l mm		EAN-No. 4000896+	€
4925-27/3	422	3	168002	109,90



4925 Sada nářadí pro silentbloky

Made in Germany

- Použití: Vytlačování a zatlačování pouzdra silentbloku u zadní nápravy VW Transporter T5

• TR14x2

• Sada nářadí na silentbloky, obsah:

4925-10 · 11 · 12 · 13 ·

14 · 15 · 16 · 17

4930-721



HAZET No.	l mm		EAN-No. 4000896+	€
4925-2505/9	259	9	167920	370,30

Made in Germany

- Výměna silentbloků z ramena nápravy / podélného vodícího ramena, krytů ložisek kol, příčného ramena dole/uvnitř, v namontovaném stavu, a spojovací tyče a příčného ramena nahoře v demontovaném stavu

• Pro silentbloky na zadní nápravě u vozidel:

VW: Golf 5 Plus / Variant / 4Motion r.v. 2005 → 2012 · Jetta / Syncro r.v. 2006 → 2012 · Scirocco r.v. 2009 → 2012 · Beetle r.v. 2012 → · Eos r.v. 2006 → 2012 · Golf 6 · Touran · Tiguan · Passat

SEAT: Altea r.v. 2004 → 2012 · Altea XL · León r.v. 2006 → 2012 · Toledo r.v. 2005 → 2009

ŠKODA: Octavia · Superb · Yeti 2004 →

AUDI: A3 / S3 r.v. 2004 → 2012 · TT / TTS Coupé/Roadster r.v. 2007 → 2012 · Q3

• Mechanická manipulace se sadou vřetene 4929-1/3 (volitelně)

• Sada nářadí na silentbloky, obsah: 4925-26 · 31 · 32 · 33 · 34 · 35 · 36 · 37 · 38 · 39 · 40 · 41 · 42 · 43 · 44 4930-721



YouTube Clip

HAZET No.		EAN-No. 4000896+	€
4925-2506/16	16	175246	391,70



4925 Sada nářadí pro silentbloky

Made in Germany

• Demontáž/montáž je možná přímo na vozidle



- Použití: Montáž a demontáž silentbloků na spodním příčném zavěšení přední nápravy
- **AUDI** A3 r.v. 2003 → 2012
- **SEAT** Alhambra r.v. 2010 · Altea r.v. 2004 → 2009 · León r.v. 2005 → 2012 · Toledo r.v. 2004 → 2009
- **ŠKODA** Octavia r.v. 2004 → 2010 · Superb r.v. 2008 →
- **VW** Caddy r.v. 2004 → 2010 · Eos r.v. 2006 → · Golf 5/6 r.v. 2003 → 2012 · Jetta r.v. 2005 → 2010 · Passat r.v. 2005 → 2011 · Scirocco r.v. 2008 → · Touran r.v. 2003 → 2010 · Tiguan r.v. 2007 → · Sharan r.v. 2008 →
- Vystředění silentbloku pro montáž bez poškození
- Není nutné složité nastavení na dílenském lisu
- Jednoduchá manipulace s mechanickým vřetenem HAZET 4929-1/3 (volitelně)
- Sada nářadí na silentbloky, obsah:
4925-54 · 55 · 56 · 57

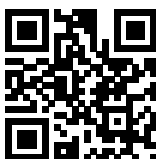

YouTube Clip



HAZET No.		EAN-No. 4000896+	€
4925-2509/4	4	191116	195,10

4925 Sada nářadí pro dvojitě silentbloky

Made in Germany

• Demontáž a montáž dvojitěho silentbloku v nosiči agregátu



- **AUDI**: A3 · Q3, TT r. v. 2003 →
- **SEAT**: León · Altea · Alhambra r. v. 2004 →
- **ŠKODA**: Octavia · Superb, Yeti r. v. 2004 →
- **VW**: Caddy · Golf 5-6 · Jetta · Sharan · Scirocco · Eos · Touran · Tiguan r. v. 2003 →
- Manipulace se sadou vřeten HAZET 4925-67/2 (volitelně)



YouTube Clip



HAZET No.		EAN-No. 4000896+	€
4925-2510/9	9	194926	363,40

4925 Sada vřeten

Made in Germany

• Pohybový závít na vřetenu a vřetenová matice způsobují vysoký tažný a tlačný výkon s nízkou vynaloženou silou (krouticí moment)



- Použití: Manipulace se sadou nářadí na dvojitě silentbloky HAZET 4925-2510/9
- **2dílná sada**:
4925-67 vřeteno TR 14x2 mm
4925-11 vřetenová matice s axiálním kuličkovým ložiskem



HAZET No.	l mm		EAN-No. 4000896+	€
4925-67/2	259	2	194940	101,60

4925 Adaptér

Made in Germany

• Adaptér pro kryt 4930-721



HAZET No.	EAN-No. 4000896+	€
4925-69	199365	14,05

4929 Sada vřeten

Made in Germany

- Manipulace se sadami pro silentbloky
4925-2504/9 · -2506/16 · -2509/4
4929-2901/4 · -2902/3 · -2903/2 · -2904/4
- Posuvný závít na vřeteni a axiální ložisko na tlačném dílu vytváří při malém vynaložení síly velkou tažnou a tlačnou sílu (utahovací moment)



- **3dílná sada**, obsah:
4929-1 vřeteno TR 12x1,5
4929-2 tlačná matice s axiálním ložiskem s 24
4929-3 šestihřanná matice



HAZET No.	l mm		EAN-No. 4000896+	€
4929-1/3	225	3	156900	120,90

Kloubové hřídele

2584 Nástrčná hlavice

Made in Germany

- Použití: Kloubový hřídel šroubový spoj (s 6mm)
- Dlouhé provedení
- S rýhováním
- DIN 3124, ISO 2725-1

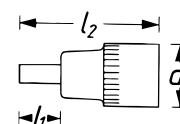

HAZET No.	s mm	l ₁ mm	l ₂ mm	d mm	EAN-No. 4000896+	€
2584	6	32	70	23	017041	19,90



Speciální nářadí

Podvozek – Kloubové hřídele



1847 Upínací kleště na manžety poloos

Made in Germany

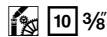

10 3/8"

- Použití: Montáž **hydrelových manžet poloos** a speciálních nerezových pásek s určenými **hodnotami momentového záběru** ve spojení např. s momentovým klíčem HAZET 6110-1 CT
- Pro **VW · AUDI · SEAT · ŠKODA · OPEL · FORD** atd.
- Ergonomická 2komponentní rukojeť HAZET



1847-02/2



1847-090/2

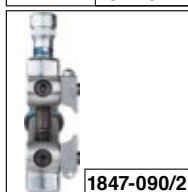

1847-090/2



1847-090/2

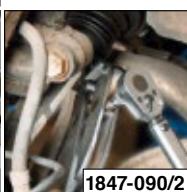

1847-090/2

HAZET No.	l / mm	EAN-No. 4000896+	€
1847	178	050918	166,70
• Pár upínacích čelistí · pro manžetu převodovky řízení AUDI A4 · A5 · A6 · A7 · Q5 ve spojení s 1847 · pro přestrojení			
1847-02/2	–	174447	36,85
• Svěrací čelisti pár · zahnuté 90° · k montáži těžce přístupných ocelových pásek / nápravových manžet Hytel			
• „Kývné“ uchycení umožňuje souběžné tlačení spony			
• Snadné přestavení kleští 1847			
Pro 1847 · 1847/3			
1847-090/2	–	206711	55,35

1847 Svorkové kleště na spony manžet náprav

Made in Germany



- Vytvoří nízká oka

- Použití: Pro **svorky manžet náprav** osobních vozidel
- Např. u **VW · AUDI · OPEL · BMW · MERCEDES-BENZ · HONDA · NISSAN · MAZDA**
- Povrch: niklováno



HAZET No.	l / mm	EAN-No. 4000896+	€
1847-1	230	007004	62,50

1847 Kleště na spony manžet

Made in Germany



- Použití: Ovládání **plynulých upínacích spon bez oček**, např. pro manžety náprav u vozidel **VW, AUDI, MERCEDES-BENZ a TOYOTA**



HAZET No.	l / mm	EAN-No. 4000896+	€
1847-11	191	079520	62,50

1847 Kleště na pojistné kroužky

Made in Germany



- Použití: Pro vzpěrné kroužky na **venkovních pojistkách**, např. převodovky
- Čelisti zahnuté v úhlu 90°, čtverečková hroty
- Pro vnější pojistky
- Povrch: chromováno



HAZET No.	l / mm	EAN-No. 4000896+	€
1847-2	200	007011	41,35

Made in Germany



- Použití: Pro rozpěrné kroužky na **VW, AUDI, OPEL, FORD**
- Pro stejnoběžný kloub nebo hnací hřídel
- Čelisti zahnuté v úhlu 10°, čtverečková hroty
- Pro vnější pojistky
- Povrch: chromováno



HAZET No.	l / mm	EAN-No. 4000896+	€
1847-3	200	007028	41,35

Made in Germany



- Použití: Pro pojistné kroužky na kloubovém hřídeli / vnějším ložisku a převodovku u **VW, AUDI, SEAT, ŠKODA, OPEL, FORD** atd.
- Čelisti zahnuté v úhlu 30°
- Povrch: chromováno



HAZET No.	l / mm	EAN-No. 4000896+	€
1847-6	200	050468	41,35



1847 Kleště na pojistné kroužky

Made in Germany

- Použití: Ovládání vzpěrných kroužků / pojistných kroužků na přírubových a kloubových hřídelech u vozidel **VW**, např. T4
- Čelisti zahnuté v úhlu 30°
- Povrch: chromováno

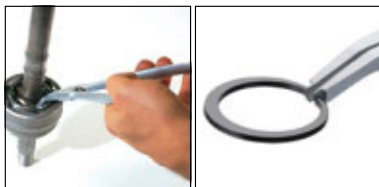

HAZET No.	l mm	EAN-No. 4000896+	€
1847-61	200	058761	41,35

1847 Sada kleští na pojistné kroužky

Made in Germany

- Snadná montáž kloubu hnacího hřídele bez poškození: Poškození ozubení kloubu a hřídele je při montáži kloubu hnacího hřídele s uvnitř ležícím pojistným kroužkem zabráněno



- Použití: Odborné, vystředěné vsazení pojistného kroužku např. při montáži kloubu na hnací hřídel
- Snadná fixace přidržovacích kleští nad pojistným kroužkem
- Při naražení kloubu sklouznou kleště automaticky dolů
- Bezpečná práce bez poškození vlnovce
- Pro hnací hřídele všech výrobců
- Ovládání kleští jednou rukou
- Nejsou potřebné žádné další pomocné nástroje

Tip pro uživatele:

- Vsaďte do kleští vhodnou poloskořepinu (průměru hřídele)
- Nasadte kleště na ozubení s předmontovaným pojistným kroužkem a upněte
- Předběžné polohování kloubu díky kónickému tvarování kleští umožňuje snadnější zavedení ozubení bez poškození
- Lze použít pro téměř všechna běžná v Evropě schválená vozidla
- SmartCase (1/3) 165-L
- Safety-Insert-System, 2komponentní vložka z měkké pěny. Vložka vhodná také pro HAZET-Assistent



1847-12



1847-124/2



1847-121/2



1847-125/2



1847-122/2



1847-126/2



1847-123/2



1847-127/2



YouTube Clip



HAZET No.	d x š x v mm	€
1847-12/15	355x235x65	372,60

1847 Jednotlivé díly

Made in Germany



HAZET No.	EAN-No. 4000896+	€
Kleště na pojistné kroužky		
1847-12	222117	96,35
Pár poloskořepin (Ø 19 mm)		
1847-121/2	221295	36,05
Pár poloskořepin (Ø 21,4 mm)		
1847-122/2	221301	36,05
Pár poloskořepin (Ø 22,3 – 23 mm)		
1847-123/2	221318	36,05
Pár poloskořepin (Ø 23,8 – 24,6 mm)		
1847-124/2	221325	36,05
Pár poloskořepin (Ø 26,2 – 26,9 mm)		
1847-125/2	221332	36,05
Pár poloskořepin (Ø 28,5 – 29,2 mm)		
1847-126/2	221349	36,05
Pár poloskořepin (Ø 30 mm)		
1847-127/2	221356	36,05

3047 Nástrčná hlavice pro rázový · strojový utahovák · dvojitý šestihran

Made in Germany



- Pro manipulaci s dvojitým 6hran. šroubovým spojem kloubové hřídele s 36 mm v náboji kola

- S jen 47 mm Ø zřetelně menší vnější průměr než u běžných standardních hlavíc
- Přesné přizpůsobení danému prostoru v náboji kol
- Pro OPEL Corsa D r. v. 2006 → Adam r. v. 2012 → Mokka r. v. 2012 → CHEVROLET Trax r. v. 2013 →
Také pro vozidla BMW · SEAT a VW
- S otvorem pro pojistný kolík nebo zajišťovací pružinu a drážku pro O-kroužek
- Povrch: fosfátováno, olejováno
- DIN 3124, ISO 2725-2

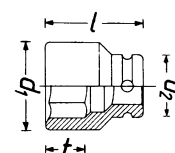

HAZET No.	s mm	l mm	d ₁ mm	d ₂ mm	t mm	EAN-No. 4000896+	€
3047-36	36	60	47	30	25	190683	19,25

900 SZ Nástrčná hlavice pro rázový · strojový utahovák · dvojitý šestihran

Made in Germany



- S otvorem pro pojistný kolík nebo zajišťovací pružinu a drážku pro O-kroužek
- Povrch: fosfátováno, olejováno
- DIN 3124, ISO 2725-2

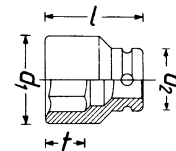

HAZET No.	l mm	d ₁ mm	d ₂ mm	t mm	EAN-No. 4000896+	€
• Manipulace se šroubovým spojem kloubových hřídelí VW Golf od r. v. 2004, Touran od r. v. 2004, Golf Plus od r. v. 2006, Eos od r. v. 2006, Scirocco od r. v. 2009, Tiguan od r. v. 2008, AUDI A3 od r. v. 2004, TT od r. v. 2007						
900 S Z-24	44	35	30	17,5	115556	13,75
• Pro matice hřídelí náprav VW Golf 4, Polo a New-Beetle, AUDI TT 1,8, ŠKODA Octavia, Superb, Fabia						
900 S Z-30	50	42	30	23,3	086573	17,50



Speciální nářadí

Podvozek – Kloubové hřídele



900 SZ Nástrčná hlavice pro rázový · strojový utahovák · dvojitý šestihran



HAZET No.	l mm	d ₁ mm	d ₂ mm	f mm	EAN-No. 4000896+	€
<ul style="list-style-type: none"> Manipulace se šroubovým spojem kloubové hřídele v náboji kola u vozidel VW Touareg od r. v. 2003 AUDI A4 od r. v. 2001, A6 od r. v. 2005, A8 od r. v. 2003, Q7 od r. v. 2007 						
900 S Z-32	50	44,5	30	22,2	115921	23,15
<ul style="list-style-type: none"> Pro matice hřídelů kol na – BMW řada 3 · 5 · 7 · Z3 · M3 · VW Polo r. v. 2001 → · SEAT Ibiza r. v. 2002 → – VW Golf Plus 1,9 TDi r. v. 2005 → · Polo 5 						
šroubení náboje kola na přední nápravě						
RENAULT Twingo 3 a SMART (453) Fortwo / Forfour r. v. 2014 →						
900 S Z-36	60	50	30	25	100132	29,55

990 LG Nástrčná hlavice

Made in Germany



- Použití: Kloubové hřídele na **VW**, **AUDI** demontáž a montáž (XZN šroub M 8)
- Dlouhé provedení
- S rýhováním
- Povrch: **TIN**
- DIN 3124, ISO 2725-1

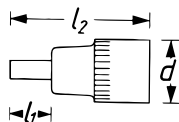

HAZET No.	l ₁ mm	l ₂ mm	d mm	EAN-No. 4000896+	€
990 Lg-8	62	100	23	047352	19,15

4935 Demontážní / montážní sada pro hnací hřídel

Made in Germany



- Použití: Oddělení kloubu hnacího hřídele a vtažení hřídele skrz náboj kola s pouze jedním nástrojem
- Oddělení kloubu hnacího hřídele od hřídele s pomocí objímek nebo vřeten ve spojení s např. **HAZET rázovým kladivem 4797-1** (není součástí dodávky)
- Vtažení hnacího hřídele skrz náboj kola u vozidel, kde lze hnací hřídel velmi obtížně vytáhnout skrz náboj kola
- Hodí se pro všechny značky vozidel
- Pro hnací hřídele s vnějším a vnitřním závitem
- Obsah (12dílná sada):
- 2 vřetena (M14, M16) k tahání hnacího hřídele skrz náboj kola nebo k oddělení kloubu od hřídele u kloubů s vnitřním závitem
- 2 pouzdra k podepření náboje kola
- 1 matice vřetena
- 7 adaptérů závitových pouzder
- M 16 x 1,5 (**VAG**, **MAZDA**)
- M 18 x 1,5 (**Volvo**, **SUZUKI**, **OPEL**)
- M 20 x 1,5 (**MERCEDES-BENZ**, **VAG**, **MITSUBISHI**, **MAZDA**)
- M 22 x 1,5 (**FIAT**, **PSA**, **BMW**, **FORD**, **OPEL**, **HYUNDAI**)
- M 24 x 1,5 (**RENAULT**, **BMW**, **MERCEDES-BENZ**, **OPEL**, **MAZDA**, **HONDA**, **VAG**)
- M 27 x 1,5 (**PSA**, **BMW**, **FORD**)
- M 30 x 1,5 (**MERCEDES-BENZ**, **PSA**, **BMW**)



4935 Demontážní / montážní sada pro hnací hřídel

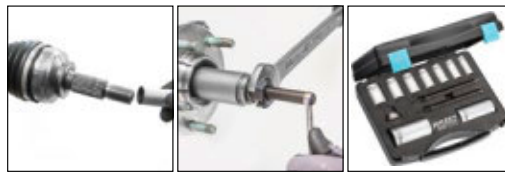

YouTube Clip

HAZET No.		EAN-No. 4000896+	€
4935-11/12	12	217434	404,40
Matice vřetena pro 4925-2505/9 · 4925-67/2 · 4927-2701/4 · 4935-11/12			
4925-11	–	168590	66,95
Vřeteno			
4935-111	–	217571	27,45
4935-112	–	217564	27,45
Vytahovací pouzdro M 16 x 1,5 pro AUDI · SEAT · ŠKODA · VOLKSWAGEN · MAZDA			
4935-1116	–	217588	26,10
Vytahovací pouzdro M 18 x 1,5 pro Volvo · SUZUKI · OPEL			
4935-1118	–	217601	26,10
Vytahovací pouzdro M 20 x 1,5 pro MERCEDES-BENZ · AUDI · SEAT · ŠKODA · VOLKSWAGEN · MITSUBISHI · MAZDA			
4935-1120	–	217618	26,10
Vytahovací pouzdro M 22 x 1,5 pro FIAT · PEUGEOT · CITROËN · BMW · FORD · OPEL · HYUNDAI			
4935-1122	–	217625	29,60
Vytahovací pouzdro M 24 x 1,5 pro RENAULT · BMW · MERCEDES-BENZ · OPEL · MAZDA · HONDA · AUDI · SEAT · ŠKODA · VOLKSWAGEN			
4935-1124	–	217632	29,60
Vytahovací pouzdro M 27 x 1,5 pro PEUGEOT · CITROËN · BMW · FORD			
4935-1127	–	217656	32,40
Vytahovací pouzdro M 30 x 1,5 pro MERCEDES-BENZ · PEUGEOT · CITROËN · BMW			
4935-1130	–	217663	33,25
Upínací pouzdro			
4935-1139	–	217670	41,60
4935-1146	–	217687	47,40

900 SZ Sada nástrčných hlavice pro rázový a strojový utahovák

Made in Germany



- Použití: Manipulace se šroubovými spoji hnací kloubové hřídele, např. s 24 mm pro **VW** Touran r. v. 2006 → a Passat C s 30 mm pro matice hřídelů náprav na **VW** Golf 4 · Polo a New-Beetle · **AUDI** TT 1,8 · **SKODA** Octavia · Superb · Fabia s 32 mm pro manipulaci se šroubovým spojem kloubové hřídele v náboji kola na **VW** Touareg r. v. 2003 → s 36 mm pro matice hřídelů náprav na **BMW** řada 3 · řada 5 · řada 7 · Z3 · M3 **VW** Polo r. v. 2001 → · Golf Plus 1,9 TDI r. v. 2005 → · **SEAT** Ibiza r. v. 2002 → šroubení náboje kola na přední nápravě **RENAULT** Twingo 3 · **SMART** (453) Fortwo / Forfour r. v. 2014 →
- Povrch: fosfátováno, olejoříváno
- DIN 3124, ISO 2725-1

900 SZ · · ·

24 · 30 · 32 · 36



HAZET No.		EAN-No. 4000896+	€
900 SZ/4	4	156375	64,05



Kola / pneumatiky

772 Výsuvný klíč na matice kol

Made in Germany

- Vytahovací díl je plně kovaný
- Pro nástrčné hlavice série 900
- Povrch: chromováno

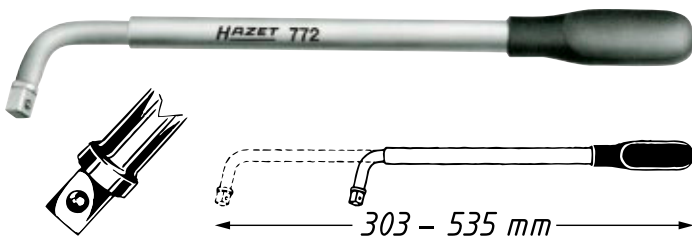

360°

HAZET No.	S mm	l ₁ mm	l ₂ mm	EAN-No. 4000896+	€
772	12,5	303	535	030897	37,80

665 Kleště na vyvažovací závaží kola

Made in Germany

- Použití: Upevnění, uvolnění a odříznutí **vyvažovacích závaží**
- Také k dilataci a stlačení přídržných pružin
- Povrch: chromováno



HAZET No.	l mm	EAN-No. 4000896+	€
665	245	029204	66,80

Made in Germany

- **Plastová hlava na straně kladiva**



- Použití: Připevňování, uvolňování a odřezávání **vyvažovacích závaží**, a také k roztahování a stlačování přídržných pružin k sobě
- Zejména pro **lakovaná závaží**
- Povrch: chromováno



HAZET No.	l mm	EAN-No. 4000896+	€
665-1	245	029228	71,40

705 Křížový klíč

Made in Germany

- Pro OA, dodávky a velkoprostorové limuzíny
- Povrch: chromováno
- DIN 3119, ISO 6788

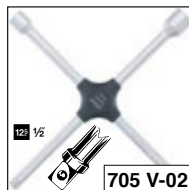

HAZET No.	S mm	l mm	EAN-No. 4000896+	€
705 N	17x19x13/16x21	380	029389	57,-
• S ■ 12,5 = 1/2" pro nástrčné hlavice série 900				
705 V-02	17x19x22x12,5	380	029396	57,05

Made in Germany

- Pro OA, dodávky a velkoprostorové limuzíny
- Povrch: chromováno
- DIN 3119, ISO 6788
- Pevně namontovaná pouzdra zabrání poškrábání v otvoru ráfku
- Barevné ochranné objímky pro rychlou identifikaci velikosti klíčů
- Všechny běžné velikosti klíčů v jednom
- S ■ 12,5 = 1/2" pro nástrčné hlavice série 900

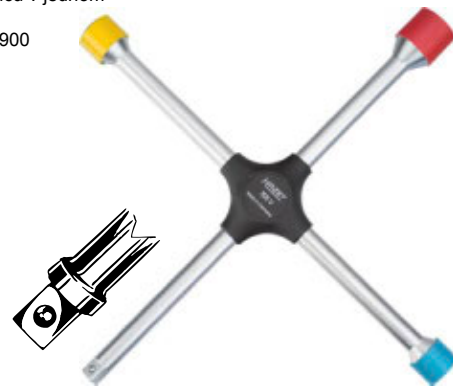

YouTube Clip

HAZET No.	S mm	l mm	EAN-No. 4000896+	€
705 V	17x19x21x12,5	380	196388	77,65

650 Páka na pneumatiky a montážní páka

Made in Germany

- Dvojitý T-profil pro vysokou stabilitu
- Povrch: chromováno



HAZET No.	l mm	EAN-No. 4000896+	€
• Pro motocykly			
650-8	199	028672	12,25
• Pro OA a dodávky			
650-12	303	028627	14,90
650-16	396	028634	19,90
650-20	500	028641	29,05
650-24	598	028658	42,10



Speciální nářadí

Podvozek – Kola / pneumatiky



650 K Páka na pneumatiky a montážní páka

Made in Germany

- Přišroubovaný, vyměnitelný plastový potah



- Použití: Pro montáž a demontáž pneumatik na ocelové a zvláště na **hliníkové ráčky**
- Povrch: chromováno

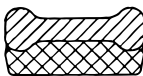

HAZET No.	l mm	EAN-No. 4000896+	€
650 K-20	500	028696	58,95

650 RF Montážní páka na pneumatiky Runflat

Made in Germany



- Optimalizované provedení (zesílené, zaoblené, tupé hrany) pro zabránění poškození na kostře pneumatiky
- Plastové ochranné pouzdro zabráňuje poškrábání ráfků a chrání proti sesmeknutí

- Použití: Bezpečná montáž bez poškození, speciálně pneumatik Runflat a pneumatik s nízkým profilem
- Zesílená stěna na pneumatikách „Runflat“ a pneumatikách s nízkým profilem je výrazně nepružnější než kostra běžných pneumatik. Použití neoptimálních montážních pák vede k poškozením pneumatiky
- Sada se skládá z montážní páky na pneumatiky Runflat 650 RF a plastového ochranného pouzdra 650 RF-01



HAZET No.	l mm	EAN-No. 4000896+	€
650 RF/2	535	206896	51,95

652 Páka na pneumatiky a montážní páka

Made in Germany



- Pro užitková vozidla · zemědělské a stavební stroje
- Těžké provedení



HAZET No.	l mm	EAN-No. 4000896+	€
652	600	028702	49,20

653 Páka na pneumatiky a montážní páka

Made in Germany



- Zejména pro pneumatiky bez duše
- Těžké provedení



HAZET No.	l mm	EAN-No. 4000896+	€
653	456	028719	33,-

666 Šroubovák na ventily

Made in Germany



- Použití: Zašroubování a vyšroubování ventilové vložky do ventilu pneumatiky
- Stlačení kolíku ventilku při vypouštění vzduchu např. u OA, dodávek a UV



666 Šroubovák na ventily

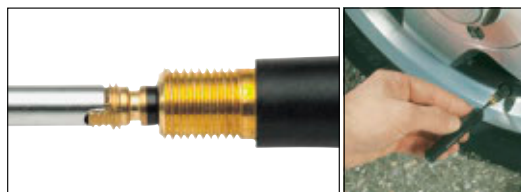

HAZET No.	EAN-No. 4000896+	€
666-1	087136	9,80

666 Měřič hloubky profilu pneumatik

Made in Germany



- Odečet v krocích po 0,1 mm k přesnému určení hloubky profilů

- Použití: Změřit hloubku profilu pneumatik
- Matný odečet
- Hloubka měření 30 mm
- Lehký a velmi dobře ovladatelný
- Stabilní provedení z tvrdé mosazi
- V praktické úložné tašce

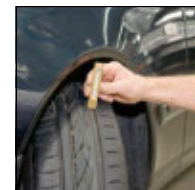

HAZET No.	EAN-No. 4000896+	€
666-5	129164	17,75

666 Kleště na krytky kolových šroubů

Made in Germany



- Hroty klešťových čelistí jsou vytvarovány pro ochranné krytky

- Použití: Stažení ochranných víček kolových šroubů na hliníkových ráfcích bez poškození
- Např. u **AUDI · VW · OPEL**
- Povrch: leštěný chrom, rukojeť s povrchovou úpravou máčením



HAZET No.	l mm	EAN-No. 4000896+	€
666-10	160	110575	31,-

654 Univerzální páka na nápravy

- Mnohostranné použití, otočný a 6násobně přestavitelný



- Použití: Demontáž kulových kloubů, příčných ramen a dalších částí nápravy



HAZET No.	EAN-No. 4000896+	€
654-1	161089	290,50



Elektrický systém / servis baterií

Elektrická zkouška

2152 N Elektronická sada

• Zkoušečka pro elektriku a elektroniku motorových vozidel



- Použití: Hledání závad na elektronických součástkách
- 3–48 V
- Ukazatel napětí: LED 5 V · 12 V · 24 V · 48 V
- Ukazatel polarity: LED pro plus nebo minus, střídavé napětí se současně svítícími LED
- Zkušební hrot, zapichovací jehla s posuvnou mechanikou,
- Navíc: krokosvorka a zkušební hrot k nasazení
- Délka kabelu: 1300 mm



HAZET No.		EAN-No. 4000896+	€
	• Sada elektroniky, 3dílná, obsah 2152 N · 2152 N-01 02		
2152 N/3	3	204151	39,80
2152 N	–	204205	29,10
	• Odbočovací svorka pro elektronickou sadu HAZET 2152 N/3		
2152 N-01	–	204199	9,80
	• Zkušební hrot pro 2152 N/3		
2152 N-02	–	204182	11,10

2152 Elektrická multifunkční zkoušečka

• **Made in Germany**



• LED indikace a integrované osvětlení

- Použití: Kontrola elektrických součástí: např. elektrických palivových čerpadel, relé, žárovek, motorů elektrického ovládání oken atd.
- Zejména pro dílenskou potřebu (motocykly, OA, NA, lodě)
- 12–24 V
- 6 m kabel a integrované osvětlení
- Jištění proti zkratu 7,5 A
- Optimální osvětlení zkoušeného místa
- Různé akustické signalizace
- Okamžité zjištění polarity díky červeně/zeleně svítící LED kontrolky
- Zjištění chybného spojení se zemí
- Průběžná kontrola např. relé, pojistek, tlačítek, kabelových svazků atd.
- Funkce samotestování



HAZET No.	EAN-No. 4000896+	€
2152-5	144440	162,-

2153 Automobilová světelná zkoušečka

• **Made in Germany**



- Zkušební hrot (délka 10 mm) a ochranná krytka
- Kabel s krokosvorkou
- 6–24 V
- Zkoušečka se svítivou žárovkou
- Nikoliv pro použití na vozidlech s elektronickými komponenty. Pro vozidla s elektronickými komponenty viz HAZET 2152N/3



HAZET No.	l mm	EAN-No. 4000896+	€
2153	120	013111	16,45

Servis baterií

4650 Plnička baterií

• **Made in Germany**



HAZET No.	l mm	EAN-No. 4000896+	€
4650-0	256	022007	16,25

4650 Kyselinoměr

• **Made in Germany**



• **Hustoměr**

- Použití: Překontrolování obsahu kyseliny v elektrolytu akumulátorů
- Stabílní plastové těleso – výrazně snížené nebezpečí prasknutí oproti skleněným tělesům



4650 Kyselinoměr



HAZET No.	l mm	EAN-No. 4000896+	€
4650-1	280	022014	17,25

4650 Šroubovák na zátky baterií

• Speciální délka umožňuje univerzální použití i u malých konstrukčních výšek



- Použití: Zašroubování a vyšroubování zátek baterie
- Profil je dimenzován pro zátky baterie
- T-rukojeť z plastu
- Povrch: chromováno

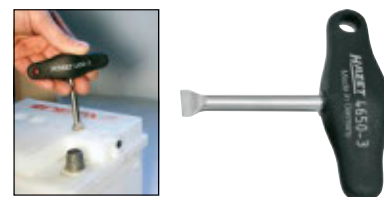

HAZET No.	l mm	± mm	b mm	EAN-No. 4000896+	€
4650-3	95	1,7	14,5	102051	12,85



Speciální nářadí

Elektrický systém / servis baterií – Kontakty / konektory / uvolňovače kabelu



4650 Čisticí kartáč na póly a svorky

Made in Germany

- Použití: Čištění pólů a svorek baterií
- S krytkou



HAZET No.	l / mm	EAN-No. 4000896+	€
4650-4	120	022038	13,65

4650 Tester baterií

Made in Germany

- Rozsah měření 6 a 12 voltů k použití na OA a motocyklech
- Použití: Rychlá diagnostika systému dobíjení baterie a stavu napětí baterie



HAZET No.	l / mm	EAN-No. 4000896+	€
4650-5	333	022045	270,-

Kontakty / konektory / vypichováky kabelů

Vypichovák KABELOVÝCH SYSTÉMŮ

- Profesionální použití
- Snadná manipulace
- Bezpečné používání
- Kvalita od přímého dodavatele – Made in Germany
- Defekty a chybné spoje lze rychle, bez námahy a profesionálně odstranit
- Univerzální použití v oblasti elektrických zařízení vozidel
- S výsuvným šoupátkem pro ochranu čepelí a proti poranění
- Použití: K vypichování konektorů bez poškození, např. plochých a válcových konektorů

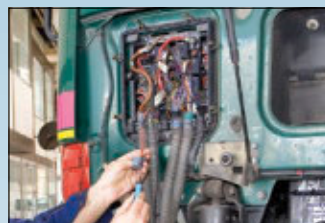
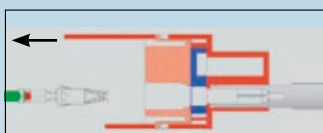
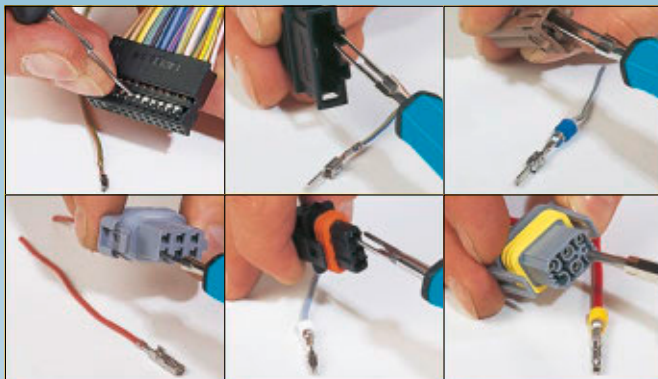

4670 Sada vypichováků KABELOVÉHO SYSTÉMU

Made in Germany

- Použití: K vypichování konektorů bez poškození, např. plochých a válcových konektorů
- Základní sada pro cca 80 % všech konektorů OA



4671
4671-1 • 4671-2 • 4671-3

4672
4672-1 • 4672-2
4672-3 • 4672-4

4673
4673-1 • 4673-2 • 4673-3
4673-4 • 4673-5



HAZET No.	ks	EAN-No. 4000896+	€
4670-1/12	12	132898	431,60

Made in Germany

- Použití: K vypichování konektorů bez poškození, např. plochých a válcových konektorů
- Doplňková sada pro VW – AUDI – SEAT – ŠKODA



4671
4671-9 • 4671-10

4672
4672-11 • 4672-12 •
4672-13 • 4672-14
4672-15

4673
4673-12 • 4673-13

4674-4



HAZET No.	ks	EAN-No. 4000896+	€
4670-4/10	10	135530	456,-



4670 Sada vypichováků KABELOVÉHO SYSTÉMU

Made in Germany

• Použití: K vypichování konektorů bez poškození, např. plochých a válcových konektorů



4671
4671-4 • 4671-5 • 4671-11

4672
4672-5 • 4672-6
4672-7 • 4672-16
4672-19 • 4672-20

4674
4674-1 • 4674-7 • 4674-8

HAZET No.		EAN-No. 4000896+	€
4670-5/12	12	135646	580,-

4671 Vypichovák KABELOVÝCH SYSTÉMŮ

Made in Germany

• Použití: Odblokování kulatých nástrčných kontaktů bez poškození

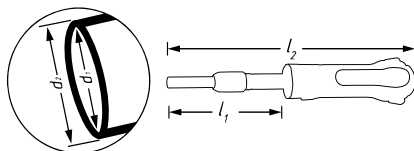

4671 Vypichovák KABELOVÝCH SYSTÉMŮ



HAZET No.	l_1 mm	l_2 mm	d_1 mm	d_2 mm	EAN-No. 4000896+	€
• ABS 4,0 mm systém kulatých konektorů						
4671-1	73	158	6	6,5	135219	42,40
• 3,5 mm systém kulatých konektorů						
4671-2	51	136	4,1	4,7	135288	31,40
• 1,5 mm systém kulatých konektorů						
4671-3	62	147	2,9	3,3	135295	28,70
• 2,5 mm kulatý konektor						
4671-4	52,5	137,5	4	4,4	135394	29,75
• LKS 1,5 mm strana kolíku						
4671-5	61,5	146,5	2,8	3,6	135400	32,90
• 1,5 mm LKS strana zdířky						
4671-6	53	138	2,8	3,1	135417	32,90
• Vypichovací nářadí pro systém kulatých konektorů 3,5 mm						
4671-9	52,5	137,5	4,2	5	135622	42,60
• Vypichovací nářadí pro systém kulatých konektorů kontaktu antény						
4671-10	53,5	138,5	4,8	5,2	135639	49,40
• Montážní pomůcka pro ABS						
4671-11	50,5	135,5	4	6,5	135653	9,95
• Zdířka ABS						
4671-15	-	-	-	-	135837	41,85
• Systém kulatých konektorů						
4671-16	57	142	2,9	3,5	135844	34,35

4672 Vypichovák KABELOVÝCH SYSTÉMŮ

Made in Germany

• Použití: Odblokování plochých nástrčných kontaktů bez poškození





Speciální nářadí

Elektrický systém / servis baterií – Kontakty / konektory / vypichováky kabelů



4672 Vypichovák KABELOVÝCH SYSTÉMŮ



HAZET No.	EAN-No. 4000896+	€
• Micro Timer II 4672-1	135042	46,40
• Maxi Power Timer 4672-2	135073	36,05
• Pit Pod / Faston 6,3 mm 4672-3	135097	37,85
• JPT / SPT 4672-4	135165	50,15
• MLK 1,2 mm 4672-5	135325	115,90
• SLK 2,8 mm P 4672-6	135356	51,15
• LSK 8 4672-7	135370	36,65
• MCP 1,5 mm / šířka kontaktu 1,5 mm 4672-11	135561	40,20
• Ploché konektory se dvěma jazýčky / šířka kontaktu 4,8 mm (např. ISO-konektor autorádia) 4672-12	135578	28,90
• Kontakt DCS 2 4672-14	135592	40,20
• Ploché kontakty se dvěma aretačními jazýčky / šířka kontaktu 2,8 mm 4672-15	135615	55,35
• E-95 4672-16	135677	49,30
• MCP 4,8 mm 4672-19	135714	36,05
• MCP 2,8 mm 4672-20	135738	36,65
• Ducon 9,5 4672-22	135813	37,45

4673 Vypichovák KABELOVÝCH SYSTÉMŮ

Made in Germany

• Použití: Odblokování mikro a standardních časovačů, sekundárního blokování a různých zajištění bez poškození



4673 Vypichovák KABELOVÝCH SYSTÉMŮ



HAZET No.	EAN-No. 4000896+	€
• Micro Standard 4673-1	134946	16,60
• Standard 2,72 mm 4673-2	134953	19,35
• Standard 1,48 mm 4673-3	134977	19,70
• Standard Timer 1,89 mm 4673-4	134991	18,65
• Vypichovák pro sekundární zajištění 4673-5	135301	23,80
• Dodatečně pro jednonábové JPT kontakty 4673-6	135332	19,25
• Sekundární zajištění FCI 4673-8	135424	37,50
• Ploché kontakty se zajištěním (různé šířky kontaktů) Yazaki 1,5 a 2,8 4673-12	135547	17,60
• Ploché kontakty se zajištěním krytu 4673-13	135554	19,85

4674 Vypichovák KABELOVÝCH SYSTÉMŮ

Made in Germany

• Použití: Odblokování různých nástrčných kontaktů bez poškození



HAZET No.	EAN-No. 4000896+	€
• SLK 2,8 mm P · S 4674-1	135363	55,75
• Kolíkové pouzdro 5-7 pólóvé 4674-8	135769	41,35
• MKS/MKR 1,5 4674-9	135806	53,90
• Kontakt VKR 4674-10	135868	55,75



Alternátor / rádia

1789 N Stahovák řemenic

Made in Germany



- Použití: Stahování řemenic osobních automobilů, SUV a transportérů
- Varianta pro řemenice se závitovými otvory, manipulace s:
 - 1 nosník, krátký pro řemenice 43 až 120 mm Ø
 - 1 nosník, dlouhý pro řemenice 95 až 210 mm Ø
 - 3 výměnné tlačné díly jako prodloužení vřetene
- Varianta pro řemenice bez závitových otvorů (pro uchycení zezadu), manipulace s:
 - 1 nosník, krátký pro řemenice 23 až 100 mm Ø
 - 1 nosník, dlouhý pro řemenice 85 až 195 mm Ø
 - Stahovací háky pro těsné prostory pro upínací hloubku do 68 mm, resp. prodloužení do 88 mm
- Varianta se 2 ozubenými háky (sáhnou pro stáhnutí do drážek řemenice, když není možné uchycení zezadu), manipulace s:
 - 1 nosník, krátký pro řemenice 80 až 140 mm Ø
 - 1 nosník, dlouhý pro řemenice 135 až 235 mm Ø

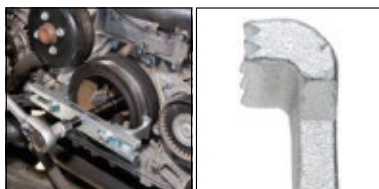

HAZET No.	EAN-No. 4000896+	€
1789 N-1	158621	334,40

2592 Adaptér pro řemenice klínového (žebrového) řemenu

Made in Germany



- Adaptér pro tisícihran
- Použití: Montáž a demontáž volnoběžné řemenice klínového (žebrového) řemenu u alternátoru
Např. pro VALEO, BOSCH atd. u VW, AUDI, ŠKODA a SEAT



HAZET No.	S mm	l mm	mm	EAN-No. 4000896+	€
2592	19,6	30	17	057443	15,80

4641 Nářadí pro drážkové (žebrové) řemenice

Made in Germany



- Použití: Montáž, resp. demontáž (žebrované) klínové řemenice s volným chodem na generátoru/alternátoru (BOSCH)
- VW · AUDI · ŠKODA · SEAT · PORSCHE · MERCEDES-BENZ · FORD · Volvo atd.

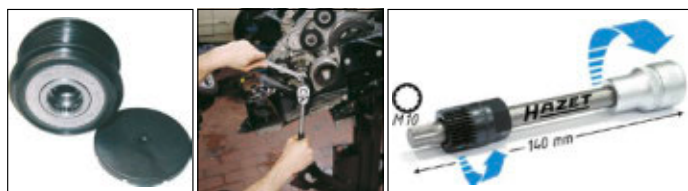
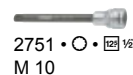

HAZET No.	l mm	mm	EAN-No. 4000896+	€
4641/2	140	2	081479	40,45

Made in Germany



- Použití: Montáž a demontáž drážkované (žebrované) volnoběžné řemenice na alternátorech
- Sada montážního nářadí pro práci na alternátorech v zamontovaném a demontovaném stavu
- Kontrola šroubových spojů
- Nástrčné hlavice TORX® a XZN pro různé vnitřní profily
- Alternátor bude zaaretován příslušnou nástrčnou hlavicí a šroubový spoj řemenice bude ovládán přes tisícihranný adaptér
- Použití u VW · AUDI · ŠKODA · SEAT · PORSCHE · MERCEDES-BENZ · FORD · RENAULT · Volvo atd.

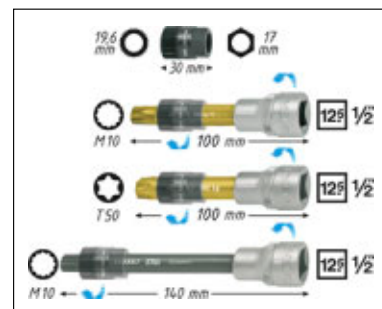
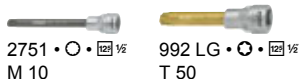
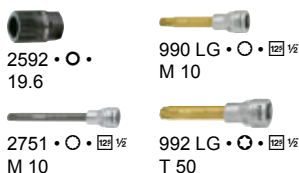

HAZET No.	mm	EAN-No. 4000896+	€
4641/4	4	103157	83,15



Karoserie / vnitřní vybavení

Oprava karoserie

Skřipcové kleště najdete v kapitole Ruční nářadí / kleště na straně 209–210

0-1900 Sada nářadí

Sada nářadí pro karosáře
• Pro dílenský vozík *Assistent*



1905 Sada vyklepávacího nářadí

Made in Germany



- Pro karosářské práce
- Kovová schránka (modrá HAZET)
- Vložka z měkké pěny



1911



1928 K



1934



1938 K



1917 N



1930



1935



1940



1919 N



1931

HAZET No.	d x š x v mm		EAN-No. 4000896+	€
1905/10 N	759x305x115	10	007448	1109,-

1911 Babka

Made in Germany



- Tvar čárky
- Délka dráhy 137 mm, šířka 55 mm



HAZET No.	EAN-No. 4000896+	€
1911	007486	84,65

1917 N Babka

Made in Germany



- Tvar Daimler Stöckle (podpatek)
- 110 x 50 mm, výška 50 mm



HAZET No.	EAN-No. 4000896+	€
1917 N	007509	94,65

1918 N Babka

Made in Germany



- Klínový tvar
- 110 x 63 mm



HAZET No.	EAN-No. 4000896+	€
1918 N	007516	69,70

428 • 6 • 7 • 8 • 10 • 11 • 13	821-2	1927	1960-5
600 N • 8 • 9 • 10 • 11 • 12 • 13 • 14 • 15 • 17 • 19 • 22 • 24	900 • 10 1/2 • 12 1/2 • 15 • 17 • 19 • 22	1929-1	1961 L-2
745-3	916 HP • 12 1/2	1930	1961 R-2
745 a-6	917-5 • 12 1/2 • 12 1/2	1931	1965/5
746-1	918-10 • 12 1/2 • 12 1/2	1934	2130
757-10	1810-250	1934-1	2140
760-2	1851-44	1934-4	2140-30 • 2140-50
799-3	1917 N	1934	2143
801 NK • 1 x 5.5	1919 N	1934-9 • 1934-10	2150
803 • 0.4 x 2.5 • 1 x 5.5 • 1.2 x 6.5 • 1.2 x 8 • 1.6 x 10	1920 N	1937 K	2165
803-PH • PH 1 • PH 2 • PH 3	1921	1940	2165-1 • 2165-2
	1922	1944-1950	
	1923	1950	

HAZET No.		EAN-No. 4000896+	€
0-1900/77	77	000241	2583,-



Speciální nářadí

Karoserie / vnitřní vybavení – Oprava karoserie



1919 N Babka

Made in Germany

- Tvar pazourku
- 120x58 mm, výška 20 mm



HAZET No.	EAN-No. 4000896+	€
1919 N	007523	77,-

1920 N Babka

Made in Germany

- Univerzální
- 76x56 mm a 65x47 mm, výška 60 mm



HAZET No.	EAN-No. 4000896+	€
1920 N	007530	70,55

1921 Babka

Made in Germany

- Dokola obroušený
- Tvar podpatku, plochý/polokulatý
- 84 x 62 mm, výška 34 mm



HAZET No.	EAN-No. 4000896+	€
1921	007554	61,20

1922 Babka

Made in Germany

- Tvar diabola
- 59x61 mm, výška 59 mm



HAZET No.	EAN-No. 4000896+	€
1922	007561	61,20

1923 Karosářský pilník

Made in Germany

- Na všech stranách opatřený seky pilníku
- Použití: Rovnění a vtahování plechů karoserie
- Pracovní plocha 162x37x27 mm



HAZET No.	EAN-No. 4000896+	€
1923	007578	160,-

1927 Vyklepávací lžíce

Made in Germany

- Pracovní plocha 52x150 mm



HAZET No.	l mm	EAN-No. 4000896+	€
1927	275	007691	63,60

1928 K Vyklepávací lžíce

Made in Germany

- Z jedné strany osekaná
- Pracovní plocha 60x30x200 mm



HAZET No.	l mm	EAN-No. 4000896+	€
1928 K	385	007707	104,60

1929-1 Vyklepávací lžíce

Made in Germany

- Široký tvar
- Zakřivený, vykrojený
- Pracovní plocha 170x50 mm



HAZET No.	l mm	EAN-No. 4000896+	€
1929-1	480	007721	108,10

1930 Vyklepávací lžíce

Made in Germany

- Široký tvar
- Silně zakřivený, dvojitě vykrojený



HAZET No.	l mm	EAN-No. 4000896+	€
1930	455	007738	132,90

1930-1 Vyklepávací lžíce

Made in Germany

- Úzký tvar
- Pracovní plocha 105x85x38 mm



HAZET No.	l mm	EAN-No. 4000896+	€
1930-1	315	007745	97,45

1931 Rovnáč páka

Made in Germany

- S koženou vložkou



HAZET No.	l mm	EAN-No. 4000896+	€
1931	410	007769	42,75



1932 Falcovací kleště

Made in Germany

• Hloubka odsazení 12 mm



- Použití: Odsazení plechových hran u plechů do tloušťky 1 mm
- Plastové krytí rukojetí
- Povrch: chromováno

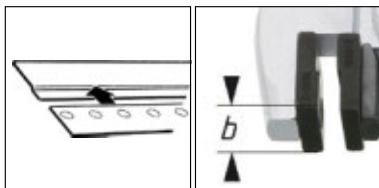

HAZET No.	l mm	b mm	EAN-No. 4000896+	€
1932-1	300	15	007806	100,40
1932-2	300	30	007868	104,70

1964 Děrovací kleště

Made in Germany

• Používá se společně s odsazovacími kleštěmi HAZET 1932



- Plastové krytí rukojetí
- Povrch: chromováno



HAZET No.	l mm	Ø mm	EAN-No. 4000896+	€
• Děrování plechů do tloušťky 1 mm při průvarovém bodovém svařování (MAG metoda svařování)				
1964-50	300	5	009039	180,40
1964-55	300	5,5	009077	180,40
1964-70	300	7	009121	180,40

1960 Karosářský sekáč na plech

Made in Germany

• Kované provedení



- Použití: Řezání plechů, svarových bodů, spár po svaru atd.
- Ochrana rukou (730 HS)
- Čepel 7 x 26 mm
- Průběžně tvrzená podle DIN (54–58 HRC)
- Úderník popuštěný dle DIN (38–46 HRC)
- Broušené břity nože
- Přebrušování bez dodatečného tvrzení
- Povrch: lakováno máčením



HAZET No.	l mm	EAN-No. 4000896+	€
1960-5	240	008759	29,45

1961 Karosářské nůžky na plech

Made in Germany

- Pro obrazce a krátké rovné řezy
- Pro plechy do 1,8 mm, VA plechy do 1,2 mm
- S pákovým převodem
- Střížná hlava kovaná v zápustce kompletně zušlechtěná
- Indukčně kalený břit s ostřím
- Ergonomické 2komponentní plastové kryty rukojetí HAZET (modrá/černá)



HAZET No.	l mm	EAN-No. 4000896+	€
• R = pravostřížné			
1961 R-1	260	008803	60,65
• L = levostřížné			
1961 L-1	260	008780	60,65

Made in Germany

- Pro obrazce a rovné průběžné řezy
- S pákovým převodem
- Střížná hlava kovaná v zápustce kompletně zušlechtěná
- Indukčně kalený břit s ostřím
- Ergonomické 2komponentní plastové kryty rukojetí HAZET (modrá/černá)



HAZET No.	l mm	EAN-No. 4000896+	€
• R = pravostřížné			
1961 R-2	260	008810	60,65
• L = levostřížné			
1961 L-2	260	008797	60,65

• **Kompaktní provedení pro práci ve stísněném prostoru a s malými oblouky**



- Pro spojitě přímé a tvarové stříhání
- Pro sílu plechu až 1,2 mm (600 N/mm²)
- Délka břitu 20 mm
- Pákový převod pro malou námahu
- Pro mimořádně malé oblouky a těžko přístupná místa
- Střížná hlava kovaná v zápustce
- Indukčně kalený břit s ostřím
- Ergonomické 2komponentní plastové kryty rukojetí HAZET (modrá/černá)

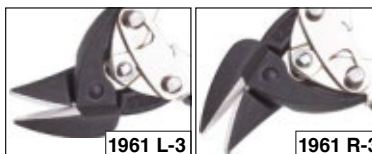

HAZET No.	l mm	EAN-No. 4000896+	€
• Levostřížné			
1961 L-3	180	176533	37,-
• Pravostřížné			
1961 R-3	180	176540	37,-



Speciální nářadí

Karoserie / vnitřní vybavení – Oprava karoserie



1963 Nýtovací kleště, ruční

- Pro bezpečné a rychlé nýtované spoje
- Pro **slepé nýty** hliník a ocel do 5 mm \varnothing , nerez do 4 mm \varnothing
- Méně síly při nýtování
- Zásobník hubic a klíč v těle kleští



HAZET No.	l mm	EAN-No. 4000896+	€
1963 N-1	255	187447	40,20

• Flexibilní použití díky nýtovací hlavě otočné o 360°



- Použití: Ke snýtování např. kovu, hliníku, plastu, kůže atd.
- 4 vyměnitelné nátrubky, prakticky uschované v zásobníku v tělese kleští
- Montážní klíč vložený v rukojeti
- Patentovaná šablona pro nýtovací otvory
- Pro hliníkové nýty \varnothing 2,4 · 3,0 · 3,2 · 4,0 · 4,8 · 5,0 mm · $\frac{3}{32}$ " · $\frac{1}{8}$ " · $\frac{5}{32}$ " · $\frac{3}{16}$ "
- ocelové nýty \varnothing 2,4 · 3,0 · 3,2 · 4,0 mm · $\frac{3}{32}$ " · $\frac{1}{8}$ " · $\frac{5}{32}$ "
- nerezové nýty \varnothing 2,4 · 3,0 · 3,2 mm · $\frac{3}{32}$ " · $\frac{1}{8}$ "



HAZET No.	l mm	EAN-No. 4000896+	€
1963-2	290	232864	50,35

1934 Držák karosářských pilníků

Made in Germany

- Nastavitelný, s napínacím šroubem
- S 1 pilníkovým listem 1934-4
- Pro ploché pilníkové listy HAZET 1934-1 až -5



HAZET No.	l mm	EAN-No. 4000896+	€
1934	355	008018	102,40

1934 N Držák karosářských pilníků

Made in Germany

- Ze dřeva
- Bez pilníkového listu

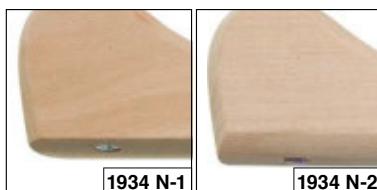

HAZET No.	l mm	EAN-No. 4000896+	€
1934 N-1	525	008155	54,95
1934 N-2	525	008179	54,95

- Pro ploché pilníkové listy 1934-1 až -5
- Pro půlkruhové (duté) pilníkové listy 1934-7

1934 Pilníkový list na karoserie

- Ploché
- Frézovaný, s šikmými zuby



- Zuby (záseky):
1 = hrubý 1934-1
2 = střední 1934-2
3 = jemný 1934-3
- Pro držák pilníkových listů HAZET 1934 a 1934 N-1
- DIN 7264 tvar A



HAZET No.	l mm	EAN-No. 4000896+	€
1934-1	350	008025	45,70
1934-2	350	008063	47,45
1934-3	350	008070	51,-

- Ploché
- Frézovaný, s radiálními zuby



- Zuby (záseky):
1 = hrubý 1934-4
2 = střední 1934-5
- Pro držák pilníkových listů HAZET 1934 a 1934 N-1
- DIN 7264 tvar A



HAZET No.	l mm	EAN-No. 4000896+	€
1934-4	350	008087	49,90
1934-5	350	008094	52,40

- Půlkruhový (dutý)
- S radiálními zuby



- Zuby (záseky): 1 = hrubý
- Pro držák pilníkových listů HAZET 1934 N-2
- DIN 7264 tvar F



HAZET No.	l mm	EAN-No. 4000896+	€
1934-7	350	008100	55,80

1934 Karosářský pilník

Made in Germany



- Zahřejte boule svařovacím hořákem. Poté bouli opracujte pilníkem. Pilováním se, v závislosti na slitině, z nerovného místa vytáhne teplo a nerovné místo se vyhladí.

- Křížový sek
- Zuby (záseky):
1 = hrubý (1934-8)
3 = jemný (1934-9)
- Zalomená
- Plastová rukojeť

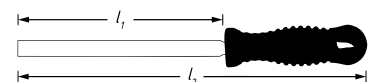

HAZET No.	l ₁ mm	l ₂ mm	EAN-No. 4000896+	€
1934-8	350	430	008124	91,55
1934-9	350	430	008131	96,75
1934-10	350	430	008032	91,50

- Zásek
- Zuby (záseky):
0 = hrubý · 1934-10



1935-1938 K Vyklepávací kladivo

Made in Germany

• Topůrko bílý ořech



HAZET No.	l mm		EAN-No. 4000896+	€
• Vyklepávací a kovářské kladivo				
• 154 mm				
• 2 různé velké kulaté plošky				
1935	308	○ 40 ○ 30	008193	57,50
• Napínací a kovářské kladivo				
• 103 mm				
• Kulatá ploška jemně čtverečková, frézovaná				
1937 K	305	□ 24 ○ 32	008209	71,40
• Napínací a kovářské kladivo				
• 96 mm				
• Kulatá ploška jemně čtverečková, frézovaná				
1938 K	310	□ 35 ○ 40	008216	77,60

1940-1943 Vyklepávací kladivo

Made in Germany

• Topůrko bílý ořech



HAZET No.	l mm		EAN-No. 4000896+	€
• Kovářské a tepací kladivo				
• 160 mm				
• Kulatá ploška a kulička				
1940	309	○ 40 ○ 17	008230	60,05
• Kovářské kladivo a kladivo s nosem				
• 135 mm				
• Kulatý pás a zahnutý, ostrý nos				
1943	309	○ 40 — 15	008261	72,35

1944-1950 Vyklepávací kladivo

Made in Germany

• Topůrko bílý ořech



HAZET No.	l mm		EAN-No. 4000896+	€
• Vyklepávací a ostré kladivo				
• 165 mm				
• Kulatý pás a rovný zaoblený nos				
1944	325	○ 41 ○ 10	008278	77,65
• Hliníkové tepací kladivo				
• ploché/vypouklé				
1950	310	○ 30	008339	35,85

1967 Fréza na bodové svary

Made in Germany

- Použití: Přesné vyfrézování bodových svarů ve zpracování plechů
- Vhodná pro každou vrtačku
- Šestihránná násada (7 mm) nedochází k překroucení ve sklíčidle
- Vyměnitelná frézovací korunka (pravotočivý závit) z rychlořezné oceli (olejované)
- Korunku lze používat oboustranně
- Nastavení hloubky řezu (*) pomocí stavěcího šroubu

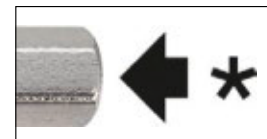

HAZET No.	l mm	Ø mm	EAN-No. 4000896+	€
1967	70	11	009312	35,60

1967 Vrtačka na bodové svary

Made in Germany

• **Samořezný středící hrot přebrousitelný**



- Použití: Přesné odvrtní bodových svarů
- Rychlořezná ocel, modřená



HAZET No.	l mm	Ø mm	EAN-No. 4000896+	€
1967-70	74	7	009343	24,55
1967-80	79	8	009350	29,20
1967-90	79	9	009367	34,45

1959 Kladiva s elastickou hmotou

Made in Germany

• **Trvale plastická výplň pro práci šetrnou k materiálu bez tvorby pruhů**



- Použití: Nasazení ozdobných lišt, práce na střešních ližinách jakož i sedlářské a čalounické práce
- Montážní nářadí pro díly citlivé na poškrábání





Speciální nářadí

Karoserie / vnitřní vybavení – Oprava karoserie



1959 Kladiva s elastickou hmotou



HAZET No.	l mm	EAN-No. 4000896+	€
• Pryžové tělo 70x70 mm 1959-2	260	102259	152,30
• Rukojeť lze otočit o 90° • Pryžové tělo 70x140 mm 1959-3	280	008728	167,20
• Rukojeť lze otočit o 90° • Bílé pryžové tělo 70x140 mm 1959-4	280	127221	182,90

1965 Dřevěné klíny

Made in Germany



- Použití: Zpracování za tepla pocínovaných ploch
- Bukové dřevo



HAZET No.	l mm	EAN-No. 4000896+	€
1965/5	5	009220	65,45

1965 Montážní klín

Made in Germany



- Použití: Karosářské práce, např. pro uvolňování ozdobných lišt, krytů, nápisů atd. bez poškození
- Plast



HAZET No.	l mm	h mm	b mm	EAN-No. 4000896+	€
1965-20	190	25	25	009183	12,65

1965 Kombinovaný montážní klín

- Zabraňuje poškození laku, plastových a kovových dílů



- Použití: Rychlé a snadné uvolnění ozdobných lišt a obložení dveří
- Manipulace s ucpávkami a plastovými klipy
- Demontáž ochranných krytek a záślepek



HAZET No.	l mm	b mm	EAN-No. 4000896+	€
1965-21	270	22	087839	10,10

2520 Stahovací hák

Made in Germany



- Použití: Demontáž přední masky u vozidel VW Transporter
- 30° zahnutý ocelový hák, široký 12 mm
- Demontáž např. přídavné světlo, vnitřní obložení, clona vnitřního osvětlení atd. VW Golf od r. v. 2004, Golf Plus r. v. 2005 →, Jetta r. v. 2006 →, Crafter r. v. 2006 →, Tiguan r. v. 2008 →, Passat r. v. 2006 →, Scirocco r. v. 2009 →, AUDI A2, A3, A4, A5, A6, A8, Q5, Q7, R8
- T-rukojeť z plastu



HAZET No.	l mm	EAN-No. 4000896+	€
2520-1	215	075218	22,20

799 Uvolňovací páka dveřní výplně

Made in Germany



- Ochranný nátěr
- Použití: Demontáž fixačních zátek na obložení dveří
- Rozevření klíče 28 mm



HAZET No.	l mm	EAN-No. 4000896+	€
799-3	268	031993	27,65

799 Kleště na uvolnění dveřního obložení

Made in Germany



- Ochranný nátěr
- Použití: Demontáž fixačních zátek u obložení dveří, ozdobných lišt a pryží nárazníku

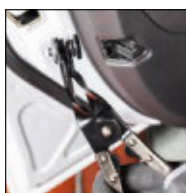

HAZET No.	l mm	EAN-No. 4000896+	€
799-4	230	032013	54,95

799 Uvolňovací páka dveřní výplně

Made in Germany



- Ochranný nátěr
- Použití: Uvolnění fixačních zátek na obložení dveří
- VW Sharan · Touareg · Touran · Phaeton
- SEAT Alhambra
- FORD Galaxy
- Optimální přenos síly při povolování díky pákové funkci
- Plastová rukojeť



HAZET No.	l mm	EAN-No. 4000896+	€
799-6	260	110346	51,-



828 LG-T Šroubovák s T-rukojetí

- Použití: Demontáž a montáž **dveřního madla** u vozidel **MERCEDES-BENZ** typ 168 · typ 169 (třída A) · typ 245 (třída B) · typ 203 (třída C) · typ 204 (třída C) · typ 212 (třída E) · 117 CLA
- Seřazení **světlo** **MERCEDES-BENZ** Actros

- Extra dlouhé provedení**
- Kulatá čepel
- Ergonomická 2komponentní T-rukojeť HAZET
- Povrch: chromováno, špička mořená

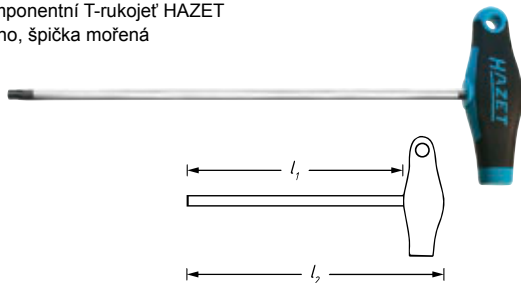

HAZET No.	l ₁ mm	l ₂ mm	Ø mm	EAN-No. 4000896+	€
828 Lg-T 20	200	226	3,86	139941	13,-

2597 Nástrčný klíč pro dveřní závěsy · zahnutý držák bitů

Made in Germany

- Použití: Montáž a demontáž dveří u řidiče, resp. spolujedce (šroubení dveřních závěsů vnitřní **TORX** šrouby T 45) a k nastavení dveří u **VW** · **ŠKODA** Fabia r. v. 2010 →, Roomster r. v. 2006 →, **AUDI** A5 r. v. 2007 →,
- Nástrčné spojení čtyřhran 9x12 mm
- S bitem **TORX** T45 (HAZET 2597-01)

- Demontáž** ve spojení s držákem nástroje HAZET 6396, **montáž** pomocí momentového klíče HAZET 6290-1CT – Zohlednit předpis VW pro utahovací moment
- Povrch: chromováno



YouTube Clip



HAZET No.	l mm	Ø mm	EAN-No. 4000896+	€
2597	95	7,82	017379	29,10

2597 Bit

- Pohon šestihran ISO 1173 C8 (5/16")
- Bit **TORX** T 45 pro 2597
- Demontáž a montáž dveří na **VW** · **AUDI** · **ŠKODA**



HAZET No.	l mm	Ø mm	EAN-No. 4000896+	€
2597-01	18	7,82	017386	8,35

Made in Germany

- Pohon šestihran ISO 1173 C8 (5/16")
- Nastavení dveří a demontáž a montáž dveří u vozidel **VW** Golf 4 (r. v. 1997 → 2006) · Golf 7 (r. v. 2012 →) · Passat B5 (r. v. 1996 → 2000) **SEAT** León (r. v. 1999 → 2006) ve spojení se zahnutým držákem bitů HAZET 2597
- Pro **šrouby s vnitřním tisícíhranem (XZN) M 10**
- Podobné DIN 65254



HAZET No.	l mm	EAN-No. 4000896+	€
2597-02	21	066667	8,35

2597 Bit

Made in Germany

- Použití: Nastavení dveří a demontáž i montáž mj. u vozidel **VW** Golf 5 (r. v. 2003 → 2008), Golf 6 r. v. 2008 →, Passat B6, Caddy r. v. 2004 → 2010, New Beetle r. v. 2011 →, Sharan 2 r. v. 2010 →, Tiguan r. v. 2011 →, Touran r. v. 2010 →
- ŠKODA** Superb r. v. 2008 →

- Pohon šestihran ISO 1173 C8 (5/16")
- Ve spojení se zahnutým držákem bitů HAZET 2597
- Pro **šrouby s vnitřním tisícíhranem (XZN) M 8**
- Podobné DIN 65254



HAZET No.	l mm	EAN-No. 4000896+	€
2597-03	21	118830	8,55

T 45 se speciální délkou

- Použití: Montáž a demontáž předních dveří na **VW**
- Ve spojení s přepínací ráčnou 2264 nebo hlavou přepínací ráčny 6408 a momentovým klíčem 6290-1CT – Respektujte předpis VW o utahovacích momentech –
- Pohon šestihran ISO 1173 C6,3 (1/4")



HAZET No.	l mm	Ø mm	EAN-No. 4000896+	€
2597-T 45	25	7,82	017393	10,20

2598 Nářadí na kliku dveří

Made in Germany

- Bezpečná a rychlá práce**

- Použití: Manipulace s obtížně dosažitelnými zajišťovacími háky (třmeny uložení) při montáži / demontáži kliky dveří
- Demontáž a montáž pouzdra válcové vložky zámku (kliky dveří) u dveří bez válcové vložky zámku
- Pro např. **VW** Passat r.v. 2005 → · Tiguan r.v. 2008 → · Golf 6 r.v. 2008 → · Golf 7 r.v. 2012 → · Amarok r.v. 2010 → · Beetle r.v. 2011 →
- K montáži dveřního zámku **VW** Fox r. v. 2005 →
- Ergonomická 1komponentní rukojeť trinamic



HAZET No.	l ₁ mm	l ₂ mm	EAN-No. 4000896+	€
2598-1	155	256	204144	19,45

828 LG-T Šroubovák s T-rukojetí

- Extra dlouhé provedení pro bezpečnou manipulaci s hluboko umístěným šroubením**

- Použití: Demontáž / montáž vnějšího zpětného zrcátka např. u **OPEL** Corsa D · Meriva B

- Extra dlouhé provedení**
- Kulatá čepel
- Ergonomická 2komponentní T-rukojeť HAZET
- Povrch: chromováno, špička mořená

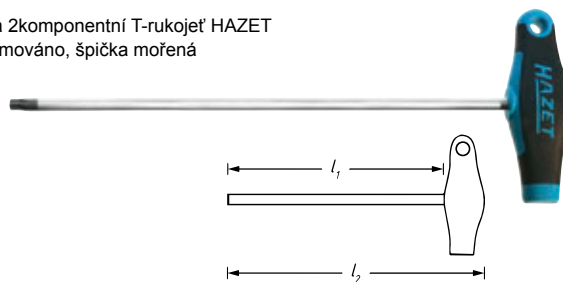

HAZET No.	l ₁ mm	l ₂ mm	Ø mm	EAN-No. 4000896+	€
828 Lg-T 40	290	325	6,65	235360	17,70



Speciální nářadí

Karoserie / vnitřní vybavení – Oprava karoserie



2534-1 Ovládací nástroj na upínací kotouče

Made in Germany

- Snadná a rychlá manipulace se svěracími kotouči
- Zabraňuje poškození na obložených spodku vozidla a izolačních štítech

- Použití: Ovládání upínacích kotoučů na obložených spodku vozidla a izolačních štítech např. na **AUDI, SEAT, ŠKODA, VW, FORD**
- Ø s rozsahem ovládání: 27 mm



HAZET No.	l mm	EAN-No. 4000896+	€
2534-1	22	224227	12,35

2797 Trubkový nástrčný klíč na nárazníky

Made in Germany

- Ovládání šroubového spoje tlumiče vzadu

- **MERCEDES-BENZ** typ 204 (třída C) kombi a limuzína · typ 205 (třída C) · **AUDI** A3 r.v. 2004 → · A4 r.v. 2001 → · A6 r.v. 2005 → · TT r.v. 2007 →
Upozornění: Ovládání šroubení přes závitovou tyč
- Umožňuje kontrolované utažení na výrobcem doporučený utahovací moment
- DIN 3124, ISO 2725-1



HAZET No.	S mm	l mm	EAN-No. 4000896+	€
2797-1	10	160	154746	16,40

2797-2 Trubkový nástrčný klíč na nárazníky

Made in Germany

- Umožňuje kontrolované utažení na výrobcem doporučený utahovací moment

- Použití: Stisknutí bočních držáků nárazníků vzadu
- Upozornění: Ovládání šroubového spoje přes závitovou tyč
- **MERCEDES-BENZ** typ 213 (třída E) r. v. 2016 →



HAZET No.	S mm	l mm	EAN-No. 4000896+	€
2797-2	8	160	210053	16,40

2797 Nástroj pro nastavení světlometů

Made in Germany

- Nastavení světlometů, resp. rozměrů mezery vůči nárazníku a kapotě motoru

- Po opravách karoserie, resp. výměně světlometů u vozidel **MERCEDES-BENZ** 205 třídy C · r.v. 2014 → a **AUDI** A7
- Nástroj přizpůsobený pro použití ve velmi stísněných prostorách
- Povrch: matně chromováno
- DIN 3124, ISO 2725-1



2797 Nástroj pro nastavení světlometů



HAZET No.	S mm	l mm	d mm	EAN-No. 4000896+	€
2797-14	14	195	18	202201	20,50

828 Šroubovák s T-rukojetí

- Použití: Nastavování světlometů u modelů **FORD**
Optimální délka zaručuje přímé použití na součásti (není nutné sesazování více nástrojů)

- Šestihránná čepel
- Ergonomická 2komponentní T-rukojeť HAZET
- Povrch: chromováno, špička mořená

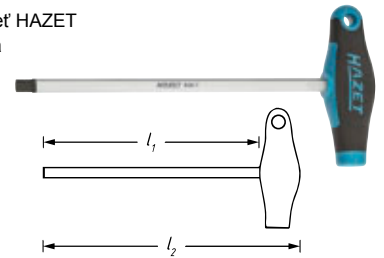

HAZET No.	S mm	l1 mm	l2 mm	EAN-No. 4000896+	€
828-7	7	200	234	210060	10,75

828 LG Šroubovák s T-rukojetí

- Použití: Nastavování světlometů u **RENAULT, AUDI**
Optimální délka zaručuje přímé použití na součásti (není nutné sesazování více nástrojů)

- Šestihránná čepel
- Ergonomická 2komponentní T-rukojeť HAZET
- Povrch: chromováno, špička mořená

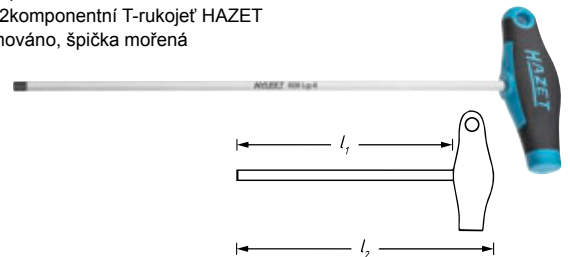

HAZET No.	S mm	l1 mm	l2 mm	EAN-No. 4000896+	€
828 LG-6	6	300	334	226672	12,20

1816 Ploché kleště

Made in Germany

- Obzvlášť plochý tvar pro použití ve zúžených konstrukčních prostorech

- Použití: Demontáž a seřízení předřizných úchytků ve vnitřním prostoru a také slunečních clon u vozidel VAG
- Plochý tvar
- Přímé provedení
- Rukojeť s povrchovou úpravou máčením



HAZET No.	l mm	EAN-No. 4000896+	€
1816 K-1	135	232949	27,75



Autoskla / rameno stěrače

4852 Sada vysklivacího nářadí

Made in Germany

• Osvědčené ruční nářadí k vyřezávání lepených skel vozidel

- Čtyřhranný řezací drát pro rychlé a snadné protnutí běžných housenek lepidla
- Pilový drát stočený ze tří ocelových drátů potažených mosazí, pro mimořádně široké a tvrdé housenky lepidla
- Robustní propichovač z pružinové oceli s velkou T-rukojetí k propíchnutí drátu
- Držák s dlouhou stopkou a stabilním závitem M4 zajišťuje stabilitu řezacího drátu zevnitř



HAZET No.		EAN-No. 4000896+	€
	• Sada nářadí k demontáži skel, obsah 4852-3 (2x) · 4 A · 5 · 6 · 7		
	• Vyřezávání lepených autoskel		
4852/6	6	129447	151,30
	• Úchytka pro uchycení řezacího drátu		
	• Vyřezávání lepených autoskel		
4852-3	–	129454	52,20
	• Držák pro vedení a přidržování řezacího drátu		
	• Vyřezávání lepených autoskel		
4852-4 A	–	164769	51,05
	• Drátový startér k proražení pásu lepidla		
	• Vyřezávání lepených autoskel		
4852-5	–	129478	30,40
	• Role řezného drátu čtyřhran 0,6x0,6 mm, 22 metrů		
	• Vyřezávání lepených autoskel		
4852-6	–	129485	14,40
	• Role kulatého řezacího drátu Ø 0,8 mm, 22 metrů		
	• Vyřezávání lepených autoskel		
4852-7	–	129492	10,05

4850 Přípravek k seřízení ostříkovačů okenního skla

• Vytažená teleskopická tyč ukazuje směr paprsku trysek na skle

- Použití: Nastavení trysek ostříkovačů okenního skla
- Úchytka / klip na kapsu
- Magnetická hlava Ø 6 mm
- Nastavovací jehla (Ø 0,7 mm) a krytka



4850 Přípravek k seřízení ostříkovačů okenního skla



HAZET No.	l_1 mm	l_2 mm	EAN-No. 4000896+	€
4850-1	155	670	022366	9,80

• Vytažená teleskopická tyč ukazuje směr paprsku trysek na skle

- Použití: Nastavení trysek ostříkovačů okenního skla
- Úchytka / klip na kapsu
- Integrované LED světlo pro jednoduché nalezení dílů v tmavém prostředí, např. v motorovém prostoru apod.
- Extra silný magnet 8 mm Ø pro zvednutí spadlých dílů
- Nastavovací jehla (Ø 2 mm)



HAZET No.	l_1 mm	l_2 mm	EAN-No. 4000896+	€
4850-2	183	682	149544	20,45

4852 Sada ochrany přístrojové desky s rukojetí

• Světlo modrý odstín upozorní na znečištění jednotlivých ochranných tabulí rychleji než běžné šedé ochranné tabule a zabrání tak znečištění interiéru

- Použití: Ochrana před poškozením přístrojové desky, vnitřních obložení a stropu vozu při demontáži skel
- Čistá, profesionální práce
- Robustní plast
- Obsah:
Ochranná tabule, zahnutá, 270x200 mm
Ochranná tabule, zahnutá, 450x300 mm
Ochranná tabule, rovná, 270x200 mm
Ochranná tabule, rovná, 450x300 mm



HAZET No.		EAN-No. 4000896+	€
4852/4	4	210114	53,05



Speciální nářadí

Karoserie / vnitřní vybavení – Užitková motorová vozidla (UV)



Volant

1776 Stahovák hlavní páky řízení · 2ramenný

Made in Germany

- Pro kuličková ložiska, ozubená kola, pastorky, páky bloku řízení a podobné díly
- Upínací svěrka přitlačí stahovací háky pevně na stanovené díly
- Povrch: zinkováno

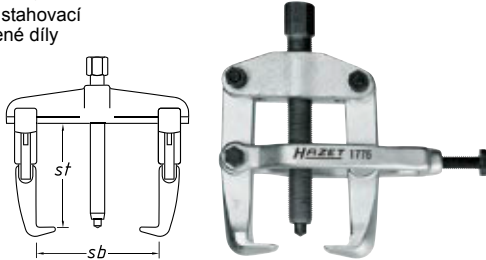

HAZET No.	sb mm	st mm	Vřeteno	EAN-No. 4000896+	€
1776-85	90	85	M18x1,5x130 mm	135943	172,80
1776-100	90	100	M18x1,5x130 mm	135950	155,10
1776-140	150	140	G½"x175 mm	135967	252,40

2223 LG Bit

- Dlouhé provedení
- Pohon šestihran podobný ISO 1173 C6,3 (¼")



HAZET No.	l mm	Ø mm	EAN-No. 4000896+	€
2223 Lg-T 30	70	5,52	015092	7,30

- Kruhová čepel
- Hodí se pro všechna osobní vozidla **MERCEDES-BENZ** r.v. → 2011 s přišroubovanou jednotkou airbagu
- Pro demontáž a montáž jednotky airbagu např. **MERCEDES-BENZ, VW, AUDI, OPEL, PORSCHE** (vnitřní **TORX** šrouby T30)

Užitková motorová vozidla (UV)

Motor

Hlava válců

2850 Nástrčná hlavice pro rázový · strojový utahovák TORX®

Made in Germany

- Manipulace se šrouby hlav válců
- Zesílené provedení
- Dlouhé provedení
- S otvorem pro pojistný kolík nebo zajišťovací pružinu a drážku pro O-kroužek
- Povrch: fosfátováno, olejováno
- DIN 3124, ISO 2725-2

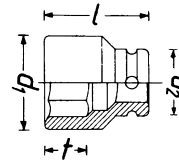

HAZET No.	l mm	d ₁ mm	d ₂ mm	Ø mm	f mm	EAN-No. 4000896+	€
2850-E 20	110	25	44	18,49	15	079681	37,90
2850-E 24	110	30	44	22,16	17,5	146758	38,45

Palivové systémy / vstřikování

2168 Klíč na palivové filtry

Made in Germany

- Snadné ovládání čtyřhranem 12,5 mm (½ palce)
- Použití: Manipulace s krytem palivového filtru u stavebních a zemědělských strojů
- Např. pro: **CLAAS** Torion, kolové nakladače **LIEBHERR** a rovněž kolové nakladače s normou spalín Euro 6 a motory **LIEBHERR, JOHN DEERE**
- Harvester 1070G, 1170G · vyvážecí stroj 1110G, 1210G, 1510G · pásový lesní jeřáb 2154G, 2154G · nakladač kulatiny 2156G, 2156G LC · lesní jeřáb, závěsné montované 337E, 437E · kolový nakladač 524K, 524K-II, 524L, 544K, 544L · polní postřikovač, samojízdný R403, R4040L, R4050L · traktory řady 6M, 6R · traktory řady 7R · žací stroje řady T · žací stroje řady W · buldozer 700K · rypadlo 210G LC Deere · Sprayer Mazzotti MAF HP · Hagie STS 10, STS 12

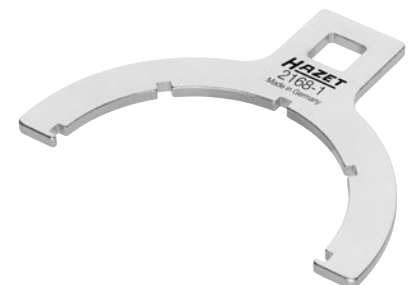

HAZET No.	EAN-No. 4000896+	€
2168-1	223251	15,90



2849 Jednostranný uzavřený klíč

Made in Germany

- Ovládání připevňovacích matic na turbodmychadle u nákladních vozidel MAN
- Zahnutý očkový klíč, přizpůsobený speciálně pro stísněné prostory
- Ergonomická 2komponentní rukojeť HAZET



HAZET No.	l mm	EAN-No. 4000896+	€
2849-15	266	159284	70,80

2871-E12 Nástrčná hlavice TORX® pro turbokompresor / koleno

Made in Germany

- Malá konstrukční výška jako nástrčný klíč s přepínací ráčnou
- Použití: Manipulace se šroubením turbokompresoru a sběrače (E12)
- U vozidel MAN TGL · TGM s motory E08
- Pohon s 17 mm Ovládání např. pomocí ráčnového očkoplochého klíče 606-17 nebo nástrčného očkového klíče 6630 d-17 a držáku nástrojů 6397 (povolování) s momentovým klíčem 6292-1 CT (utahování)
- Nutné z důvodu nedostatku prostoru
- Povrch: fosfátováno, olejováno



HAZET No.	l mm	EAN-No. 4000896+	€
2871-E 12	28	201730	11,25

4550 Klíč pro vstřikovací potrubí

Made in Germany

- Nástrčná hlavice otevřený dvojitý 6hran
- Použití: Ovládání šroubení u vstřikovacího vedení
- Povrch: chromováno
- DIN 3124, ISO 2725-1
- Na užitková vozidla MAN s motory D 20 – vstřikovací systémy Common Rail
- Krátké provedení
- Pohon 10 = 3/8"



HAZET No.	S mm	l mm	d ₁ mm	d ₂ mm	f mm	EAN-No. 4000896+	€
4550-3	17	83	27	18	8	104307	59,55

Made in Germany

- Odborné ovládání šroubového spoje vstřikovacího vedení
- Použití: Manipulace s převlečnou maticí u vysokotlakého vedení u vstřikovacího ventilu Common Rail vstřikovacího systému
- Otevřená nástrčná hlavice s dvojitým 6hranem pro vstřikovací potrubí
- Utahovacího momentu požadovaného výrobcem se dosáhne použitím momentového klíče HAZET (respektujte údaje výrobce)
- Povrch: mořeno
- DIN 3124, ISO 2725-1
- DAF Euro 6 motory MX11/ MX13 např. XF · CF
- Pohon 12,5 1/2"



HAZET No.	S mm	l mm	d ₁ mm	d ₂ mm	f mm	EAN-No. 4000896+	€
4550-21	21	91	33	32	19	204137	28,60

4558 Čepový klíč na tlakové matice

Made in Germany

- Použití: Ovládání tlakové matice na držáku trysek
- Povrch: chromováno



HAZET No.	l mm	d ₁ mm	d ₂ mm	EAN-No. 4000896+	€
4558	72	-	-	021888	45,10
4558-1	120	29	36	050529	63,15
4558-2	69	28,4	25	057344	60,70

1788 T Rázový vytahovací přístroj

Made in Germany

- Použití: Demontáž pevně usazených vstřikovačů Common-Rail bez demontáže hlavy válců
- Rázový vytahovací přístroj (kluzné kladivo – kluzná hmotnost 200 g) s přípojným závitem M 10
- Vytahování krytů s vnitřním závitem, kuličkovým ložiskem, kotouči atd.
- Ve spojení se sadou závitových čepů 1788 T-1/6 a vnitřním vytahovákem 1788 N-15 do 35
- Také ve spojení se stahovákem vstřikovačů 4797-5



HAZET No.	M	l mm	EAN-No. 4000896+	€
1788 T-1	M 10	226	134304	27,90

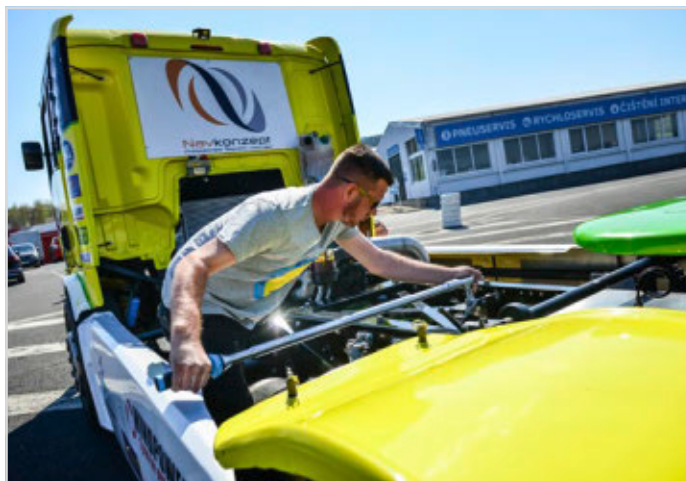



Speciální nářadí

Užitková motorová vozidla (UV) – Motor



4797 Vytahováč vstřikovačů

Made in Germany

- Použití: Demontáž pevně usazených vstřikovačů Common-Rail bez demontáže hlavy válců



Snadné vytahování vstřikovačů ve spojení s rázovým vytahovacím přístrojem např. HAZET 1788 T-1

- **Drapak na vstřikovače** s vnitřním závitem M 10 x 1,5 mm
- **MAN** motory D08 · D20 · D26 · D28
- Upravené pro velmi stísněný prostor v hlavě válce
- Uchopení vstřikovače drapakem v horní části bez poškození



HAZET No.	l mm	EAN-No. 4000896+	€
4797-5	174	176137	170,80

2168 Klíč na filtr Ad-Blue®

Made in Germany



- Manipulace s víkem tělesa filtru při výměně filtračního prvku filtru Ad-Blue® (karmabidový filtrační prvek) u UV MERCEDES-BENZ s motory Blue-Tec®, např. Actros, Atego, Axor, Econic

- Výrobce doporučený utahovací moment (respektujte pokyny výrobce) bude dosažen např. s momentovým klíčem HAZET 6110-1 CT
- Ø 46 mm

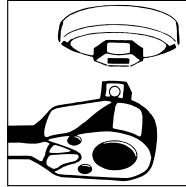

HAZET No.	Ø mm	EAN-No. 4000896+	€
2168-46	59	156252	29,95

Diagnostika

4800 Tester chladicích systémů pro zemědělské stroje

Made in Germany



- Použití: Kontrola netěsností v chladicích systémech a topných okruzích
- Přifazení k typům vozidel: www.hazet.de → **Poradce pro použití** → **Adaptér chladiče 4800**
- Plastová skříňka
- 4800-1 pumpa pro natlakování chladiče do 2,5 bar
- 4800-2 mezikus flexibilní hadice
- 4800-3 adaptér chladiče pro **AMAZONE** Pantera **CLAAS** Jaguar · Lexion · Scorpion · Ares · Atlas · Ceres **FENDT MASSEY FERGUSON** s nádrží číslo 180224M92 a 4296015M1 **CASE** Quadtrac · Magnum
- 4800-4 A adaptér chladiče pro **CASE** Puma · SBS · LBS · Optum · Maxxum · CVX **NEW HOLLAND** TVT · T7, T7 Elite Pack · T6 **FENDT** Vario2000 → kombajny řady L **CLAAS** Arion · Axion motory **DEUTZ** 3,6 PowerPack · BF6M1013FC · TCD2013L6 2V a 4VGenset 250kV
- 4800-5 A adaptér chladiče pro **FENDT** Farmer 3001988 → typ 500 · typ 700 · Vario1988 → 2000
- 4800-20 adaptér chladiče pro **CLAAS** Xerion · Tucano a rovněž všechny nové stroje **CLAAS** s vyrovnávací nádrží **MERCEDES-BENZ**



HAZET No.	6	EAN-No. 4000896+	€
4800/6	6	216482	361,60

4800 Tester pro chladicí systém užitkových vozidel

Made in Germany



- Použití: Kontrola netěsností v chladicích systémech a topných okruzích
- Přifazení k typům vozidel: www.hazet.de → **Poradce pro použití** → **Adaptér chladiče 4800**
- Plastová skříňka
- 4800-1 pumpa pro natlakování chladiče do 2,5 bar
- 4800-2 mezikus flexibilní hadice
- 4800-3 adaptér chladiče pro **DAF** 45 r. v 05/1991 → 12/2000 **DOOSAN** kolové rýpadlo S, pásové rýpadlo DX **KAESER** Mobilair **LIEBHERR** A308-316 **MERCEDES-BENZ** Vito, Viano, Solaris **NISSAN** vidlicový vozík **PUTZMEISTER** BSA 1409 **SCANIA** Vabis
- 4800-5 A adaptér chladiče pro **COMPAIR** Mobil kompresor s vyrovnávací nádobou **VW** **LINDE** vidlicový vozík **PUTZMEISTER** BSA 1407D · BSA 2110 HP-D **RENAULT** Midlum r. v. 01/2000 → 12/2013 **Volvo** FE r. v. 05/2006 → FL r. v. 03/2000 →
- 4800-25 adaptér chladiče pro autobusy **MAN** jako Lions Coach, Lions Star, Lions Comfort, Lions City **MERCEDES-BENZ** Citaro r.v. 01/1998 **IVECO** Euro-Star, Euro-Tech, Euro-Truck, Stralis, Daily s černým uzávěrem **MAN** F90, F2000, TGA r. v. 03/2000 →, TGL r. v. 04/2005 →, TGM r. v. 10/2005 →, TGS r. v. 10/2007 → 01/2012, TGX r. v. 10/2007 → 01/2012 **MERCEDES-BENZ** užitkové vozy Actros, Atego 1217 r. v. → 1999, Eco 8401, SK1728, Antos, Arocs, Atego r. v. 1998 → 2013, Axor r. v. 09/2001 → 10/2004, Econic, Zentros
- 4800-26 adaptér chladiče pro **DAF** CF, XF Euro 6 r. v. 2013 →
- 4800-27 adaptér chladiče pro **MERCEDES-BENZ** Atego r. v. 2014 →
- 4800-28 adaptér chladiče pro **MERCEDES-BENZ** Actros EURO 6 s vyrovnávací nádrží HEYCO r. v. 2014 → **MAN** TGX, TGS EURO 6 s vyrovnávací nádrží HEYCO r. v. 2012 →



HAZET No.	8	EAN-No. 4000896+	€
4800/8	8	216499	657,-



4800 Adaptér pro chladiče

Made in Germany

- Použití: Kontrola netěsnosti v chladicích systémech a topných okruzích
- Rozšíření sortimentu pro stávající tester chladicího systému HAZET 4800**
- Závit přesně přizpůsobený otvoru vyrovnávací nádoby
- Se spojovací vsuvkou pro napojení na rychlospojku tlakovací pumpy na chladiče 4800-1 a mezikus 4800-2 nebo vakuový plnicí přístroj HAZET 4801-1 a 4802-1



HAZET No.	EAN-No. 4000896+	€
• SCANIA 143 · řada G · P a R		
4800-29	222780	86,85
Adaptér chladiče pro		
• CLAAS Xerion · Tucano		
• IVECO Euro-Star · Euro-Tech · Euro-Truck · Daily s černým uzávěrem		
MAN F90 · F2000 · TGA r. v. 03/2000 → TGL r. v. 04/2005 → TGM r. v. 10/2005 → TGS r. v. 10/2007 → 01/2012 · TGX r. v. 10/2007 → 01/2012		
• MERCEDES-BENZ UV Actros · Atego 1217 r. v. → 1999 · Eco 8401 · SK1728 · Antos · Arocs · Atego r. v. 1998 → 2013 · Axor r. v. 09/2001 → 10/2004 · Eonic · Zentros		
4800-20	144242	61,90
Adaptér chladiče s úhlovou hadicovou přípojkou, obzvlášť vhodný pro práci ve stísněných prostorech pro		
• Např. autobusy MAN jako Lions Coach · Lions Star · Lions Comfort · Lions City		
• MERCEDES BENZ Citaro r. v. 01/1998 · Actros · Atego 1217 r. v. → 1999 · Eco 8401 · SK1728 · Antos · Arocs · Atego r. v. 1998 → 2013 · Axor r. v. 09/2001 → 10/2004 · Eonic · Zentros		
• IVECO Stralis · Euro-Star · Euro-Tech · Euro-Truck · Daily s černým uzávěrem		
• CLAAS Xerion · Tucano		
• MAN F90 · F2000 · TGA r. v. 03/2000 → TGL r. v. 04/2005 → TGM r. v. 10/2005 → TGS r. v. 10/2007 → 01.2012 · TGX r. v. 10/2007 → 01/2012		
4800-25	203857	81,50
• DAF Cf a XF Euro 6 r. v. 2013 →		
4800-26	214495	77,75
• MERCEDES-BENZ Atego r. v. 2014 →		
4800-27	214501	99,70
• MERCEDES-BENZ Actros EURO 6, r. v. 2014 → s vyrovnávací nádrží HEYCO		
MAN TGX a TGS EURO 6, r. v. 2012 → s vyrovnávací nádrží HEYCO		
FENDT Ideal 8 · Ideal 9 · 900 Vario · 1000 Vario		
4800-28	214518	99,70



4802 Vakuový přístroj pro plnění chladičů užitkových vozidel

Made in Germany

- Použitelný ve spojení s jednotlivými nebo univerzálními adaptéry, např. 4801-2/3



- Použití: Vakuová zkouška těsnosti chladicího systému před plněním
- Bezbulbinové plnění okruhu chlazení a topení u nákladních vozidel · autobusů · zemědělských strojů a stavebních vozidel**
- Nová konstrukce vakuového přístroje pro plnění chladiče zajišťuje rychlejší dosažení požadovaného vakua a tím rychlejší plnění chladicího systému
- Rychlejší průtok chladicí kapaliny: **80 litrů za cca 20 minut**
- Plnění je možné jak s univerzální zátkou, tak i s pevným krytem
- Žádná ztráta chladicí kapaliny v důsledku přetečení chladicího systému
- Již není nutné zvláštní ovládání pomocí diagnostických testovacích přístrojů



YouTube Clip

HAZET No.	EAN-No. 4000896+	€
4802-1	200030	355,90

Olejový servis

2169 Klíč na olejové filtry

Made in Germany

- Použití: Manipulace s tělesem olejového filtru z plastu

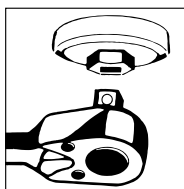

HAZET No.	mm	mm	EAN-No. 4000896+	€
• 18hran s 135 mm				
• Na užitková motorová vozidla MAN konstrukčních řad F 2000 a TGA				
2169-5	24	148	100330	31,80
• Pohon: vnější 6hran s 24 mm / □ pohon 12,5 1/2"				
• Pohon: 15hran s 105 mm				
• Např. pro: Volvo · SCANIA · RENAULT · MAN · IVECO · FIAT · FODEN · IRISBUS · ASTRA · CATERPILLAR · LIEBHERR · JOHN DEERE · KOMATSU · FAUN · MITSUBISHI				
• Uťahovacího momentu doporučeného výrobcem vozidla lze bezpečně dosáhnout pomocí momentového klíče HAZET (pozor: respektujte hodnotu utáhovacího momentu stanovenou výrobcem)				
2169-9	24	-	116690	19,25

Made in Germany

- Kované provedení



- Použití: Montáž a demontáž olejových filtrů a vík tělesa olejového filtru při výměně olejové vložky
- Povrch: chromováno





Speciální nářadí

Užitková motorová vozidla (UV) – Servis brzd



2169 Klíč na olejové filtry

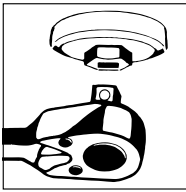

YouTube Clip

HAZET No.	mm	Ø mm	EAN-No. 4000896+	€
-----------	----	------	------------------	---

• Šestihran s 32 mm
OPEL Astra · Corsa 1,9 I CDTi · Astra 2,0 CDTi
VW Passat · Golf 6 s 1,6 a 2,0 CR-TDi · Passat B7 1,6 · 2,0 diesel · Golf 7 2,0 benzínový · Polo 5 1,2 I-1,4 I TDi · Polo 1,2 I benzínový r. v. 2005 → · Transporter T5 1,9 I diesel r. v. 2004 → · Touran TDi · Tiguan r. v. 2007 → 1,4 I (90/118 kW) 2,0 I dieselové motory · **AUDI** A6 3,2 I TSI · V6 r. v. 2004 → · A4 diesel r. v. 12/2007 →
BMW 530d M57 r. v. 2008 →
 Pro močovinné filtry Ad-Blue® **MAN** např. TGX

2169-32	32	43	082346	24,60
---------	----	----	--------	-------

• Šestihran s 36 mm
 např. pro **MERCEDES-BENZ** motor 116 MB · 100 D transporter · Actros MP 1 · MP 2 · **BMW** M 52 6-válc.: řada 3 · řada 5 · M 60-8-válc.: řada 5 · řada 7 · řada 8 · M 73-12-válc.: řada 7 · řada 8 · řada 1 (E87): 118d · 120d · řada 1 (F20) 118i · **OPEL** Vectra B DI 16 V · Insignia · **VW** Lupo 1,2 TDi · Polo 5 1,2 I · Golf 6 1,4 I SRE/TSI · Touareg TDi · T5 2,5 D · Passat B7 3,6 I FSI · **AUDI** 6-válc. benzínový od 12/2007
 Pro palivový filtr **MAN** např. TGA

2169-36	36	50	086566	26,20
---------	----	----	--------	-------

2171 Klíč na olejové filtry

Made in Germany

• Ocelová páska nastavitelná do sedmi poloh

• Použití: Manipulace s olejovými filtry např. jako montážní klíč pro olejový a palivový filtr u užitkových vozidel **MAN**



HAZET No.	l mm	Ø mm	EAN-No. 4000896+	€
2171-1	160	80–110	013418	41,90
2171-2	230	75–110	013432	45,20

2171 Řetěz na olejový filtr

Made in Germany

• Otevření řetězu na olejový filtr umožňuje použití i v místech, která jsou z důvodu konstrukce špatně přístupná

• Použití: Manipulace s olejovými filtry a pro ovládání kartuší sušičů vzduchu



YouTube Clip



HAZET No.	Ø mm	EAN-No. 4000896+	€
2171-8 Lg	50–150	203703	88,65

Jednotlivé a náhradní díly od strany 482 po stranu 490

Servis brzd

2195 Klíč na kartuše

Made in Germany

• Kované provedení

- Použití: Manipulace s kartuší s granulátem u užitkových vozidel s vysoušečem stlačeného vzduchu
- Design „Made by HAZET“
- Negativní nastavení ramen
- MAN č. 8099606-0307
- Povrch: mořeno, olejováváno



HAZET No.	Ø mm	EAN-No. 4000896+	€
2195	90–140	014101	191,70

2784 Nástrčná hlavice pro brzdové třmeny

Made in Germany

• Pohon umožňuje přenos velkých uvolňovacích sil

- Použití: Pro ovládání šroubového spoje brzdového třmenu (brzda Knorr) u užitkových vozidel **MERCEDES-BENZ**, např. Actros Ovládání horního šroubu příčného ramena na **MAN** TGA
- Umožňuje kontrolované utažení šroubů s utahovacím momentem stanoveným výrobcem (dodržte hodnoty zadané výrobcem) např. s momentovým klíčem HAZET 6144-1 CT
- S rýhováním
- S odjišťovacím čepem pro kolíkovou pojistku
- DIN 3124, ISO 2725-1

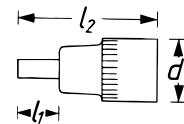

HAZET No.	S mm	l ₁ mm	l ₂ mm	d mm	EAN-No. 4000896+	€
2784-14	14	60	112	33,2	155583	33,40

2784 Sada nástrčných hlavice pro brzdové kotouče

Made in Germany

• Pohon umožňuje přenos velkých uvolňovacích sil

- Použití: Manipulace se šroubením brzdových kotoučů u vozidel **MERCEDES-BENZ** Actros 2. generace r. v. 2011 →
- Vyměnitelná nástrčná hlavice pro rázový a strojový utahovák T60
- DIN 3124, ISO 2725-2



HAZET No.	l ₂ mm	Ø mm	mm	EAN-No. 4000896+	€
2784-T 60/4	120	13,25	4	188611	68,-

Nezávazně doporučená ceníková cena bez DPH – Platí do 31.12.2021



2871 Nástavec TORX® pro brzdový třmen

Made in Germany

• Pro manipulaci se šrouby brzdových třmenů na užitkových vozů MAN



- Použití: Šroubení brzdových třmenů E20
- Ovládání např. nástrčným očkovým klíčem HAZET 6630 d-22 ve spojení s držákem nářadí 6397 (uvolnění), resp. momentovým klíčem 6293-1 CT nebo 6295-1 CT (utažení)



HAZET No.	l mm	d mm	mm	t mm	EAN-No. 4000896+	€
• Např. pro MAN TGM a TGL						
2871-E 18	39,5	23,4	16,70	13,5	176175	13,60
• Např. pro MAN TGM · TGA						
2871-E 20	39,5	25,7	18,49	15,9	148790	14,15
• Např. pro MAN TGA · TGS · TGX						
2871-E 24	39,5	35	22,16	19,7	148783	15,45

2872 Rázový utahovák TORX® se 2 údernými plochami

Made in Germany

• Použití klíčů při demontáži a montáži šroubových spojení brzdových třmenů ušetří demontáž páky spojovací tyče

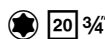

- Použití: Ovládání šroubů TORX® na šroubových spojích brzdových třmenů na přední nápravě a vlečených nápravách užitkových motorových vozidel
- Odborné utahování šroubů momentovým klíčem podle údajů výrobce
- Plocha klíče s laserem naneseným vzorcem pro výpočet správné účinné délky

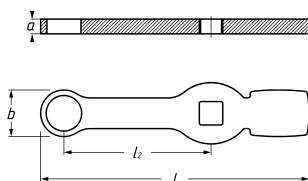

HAZET No.	l mm	l2 mm	a mm	b mm	mm	EAN-No. 4000896+	€
Např. pro MAN TGL TGM							
2872-E 18	215	120	12	30	16,70	201235	53,75
2872-E 20	216	120	12	32	18,49	201242	54,-
Např. pro MAN TGA TGS TGX MERCEDES-BENZ Atego 970-976 – vozidla se vzduchovým odpružením šroubení brzdového třmenu u zadní osy							
2872-E 24	219	120	12	38	22,16	201259	54,30

2872 FS Rázový očkový klíč · dvojitý šestihran se 2 nárazovými plochami

Made in Germany

• Použití na nákladních vozidlech, autobusech, přívěsech a nápravách návěsů bez demontáže kola



- Použití: Ovládání brzdových válců u vstřikovacího vedení
- Také pro šroubení brzdových válců čnějící daleko do ráfku
- Laserem nanesený vzorec pro rychlý přepočít výrobce zadaného utahovacího momentu
- 2 nárazové plochy umožňují cílené působení síly kladiva
- Úspora času cca 20 minut
- Mimořádně stabilní a extrémně zatížitelný



YouTube Clip



HAZET No.	a mm	b mm	EAN-No. 4000896+	€
2872 FS-24	12	38	209989	104,90

2872 SZ Rázový očkový klíč · dvojitý šestihran se 2 nárazovými plochami

Made in Germany

• Profil s dvojitým 6hranem umožňuje nasazení i na těžko přístupné šroubové spoje



- Použití: Ovládání šroubení brzdových třmenů na užitkových motorových vozidlech
- Odborné utahování šroubů momentovým klíčem HAZET podle údajů výrobce
- Plocha klíče s laserem naneseným vzorcem pro výpočet správné účinné délky

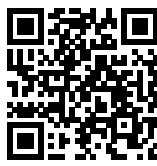
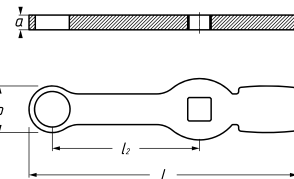

YouTube Clip

HAZET No.	l mm	l2 mm	a mm	b mm	EAN-No. 4000896+	€
Např. pro brzdový třmen SAF na MERCEDES-BENZ Atego a Actros						
2872 SZ-24	219	120	12	38	204175	51,15
Např. pro DAF XF95/ XF105/ XF						
2872 SZ-26	219	120	12	38	203727	51,30
Např. pro MERCEDES-BENZ Atego · Actros · KÄSSBOHRER Busse Volvo FH						
2872 SZ-27	220,5	120	12	38	207183	51,50

4969 Uvolňovací nástroj pro rychlospojky hadic stlačeného vzduchu

Made in Germany

• Ovládání možné plochým klíčem vel. 13 mm (HAZET 600N-13), nejsou potřebné žádné další pomocné nástroje



- Použití: Bezproblémové uvolnění rychlospojek s \varnothing 6 · 8 · 10 · 12 mm
- Pro konektory DIN 74324 6x1,0 · 8x1,0 · 10x1,0 · 12x1,5 · 12x2,0 mm
- Umožňuje rozpojení znečištěných vedení a konektorů
- Použití jednou osobou
- Zabránění zraněním
- Úspora času a nákladů



YouTube Clip



HAZET No.	EAN-No. 4000896+	€
4969-612	204281	65,-

4971 Vratné zařízení pro brzdové třmeny

Made in Germany

• Dodatečné seřizování s nástrčným klíčem s 12 mm



- Použití: Manipulace při dodatečném seřizování (dodatečné seřizování brzdových třmenů) kotoučových brzd Knorr Bremse nákl. autom., omnibusu, traileru a os přívěsu všech značek
- Speciální profil s 11 zuby



HAZET No.	l mm	d1 mm	d2 mm	t mm	EAN-No. 4000896+	€
4971-11	18	15	11,5	9,8	218257	7,50



Speciální nářadí

Užitková motorová vozidla (UV) – Podvozek



4971 Vratné zařízení u brzd

Made in Germany

• Bezpečný přenos síly u vratného zařízení



- Použití: Zpětné vrácení brzdových třmenů **WABCO** bez demontáže brzdového válce
- Speciální násada v ráčnovém klíči zaručuje bezpečný přenos síly u vratného zařízení
- Pro brzdové třmeny **WABCO** u **MERCEDES-BENZ** Actros, Antos, Arocs
- Neklouzavá 3komponentní rukojeť HAZET – pro vysoký přenos síly



HAZET No.	l mm	EAN-No. 4000896+	€
4971-12	454,4	232857	73,80

4972 Zvedací pomůcka

Made in Germany

• Bezpečná práce, která šetří záda v podmínkách se zúženým místem v podběhu kola u užitkových vozidel, autobusů, návěsů a náprav přívěsů

- Použití: Bezpečné uchopování a pohybování těžkými konstrukčními díly např. při demontáži a montáži brzdových třmenů a nábojů kol u užitkových vozidel.
- Uspodňuje nasazování šroubů
- Zohlednění různých poměrů namontování brzdových třmenů
- Jednoduchá obsluha
- Je možná jednoruční obsluha přes vřetenou
- Není potřeba druhá osoba
- Rozsah nastavení min./max.: 716 – 911 mm



YouTube Clip

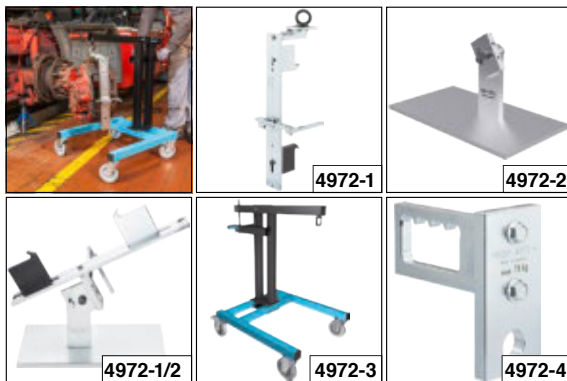

HAZET No.	l mm	EAN-No. 4000896+	€
Zvedací pomůcka sestavující ze zvedací pomůcky 4972-3, – držáku brzdového třmenu 4972-1 a držáku kolového náboje 4972-4			
4972-1/3	3	215799	1260,-
Držák brzdového třmenu			
4972-1	–	215423	371,50

4972 Zvedací pomůcka

HAZET No.	l mm	EAN-No. 4000896+	€
Montážní pomůcka pro brzdový třmen sestavující z držáku brzdového třmenu 4972-1 a otočného ložiska 4972-2			
4972-1/2	2	215195	551,-
Naklápací ložisko			
• Vložka pro držák brzdového třmenu 4972-1			
• Demontáž a montáž brzdových třmenů u nákladních automobilů, omnibusů, návěsů a náprav přívěsů, které jsou namontovány v diagonální „poloze hodinových ručiček mezi 20 a 17 hod.“			
• Umožňuje snadné nasazení šroubů i v nepříznivých polohách			
• Spojte naklápací ložisko s držákem brzdového třmenu a umístěte např. zvedacím vozíkem pod brzdový třmen			
4972-2	–	215393	175,30
Zvedací pomůcka samostatná, bez držáku brzdového třmenu 4972-1 a držáku kolového náboje 4972-4			
4972-3	–	215782	833,-
Držák kolového náboje			
• Použití se zvedací pomůckou UV 4972-3, resp. 4972-1/3			
Demontáž a montáž kolových nábojů			
4972-4	–	216031	89,85

Podvozek

Ložisko kola / náboj kola

1790 Stahovák kulových kloubů

Made in Germany

- Použití: Vytlačení čepů kulových kloubů u pákách řízení, tyčích řízení, stabilizátorech atd. u užitkových automobilů těžké konstrukce
- Povrch: pozinkováno, pasivováno (bez Cr6)

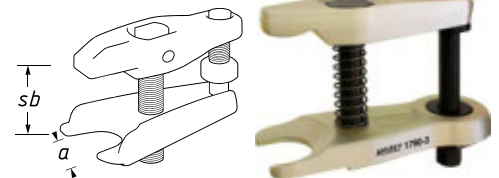

HAZET No.	a mm	sb mm	EAN-No. 4000896+	€
1790-3	40	85	145454	237,80

Made in Germany

• S hydraulickou podpěrou

- Použití: Sílu šetřící vytlačení čepů kulových kloubů a bezpečné vymontování kulových kloubů
- Povrch: zinkováno, žlutě pasivováno (bez Cr6)

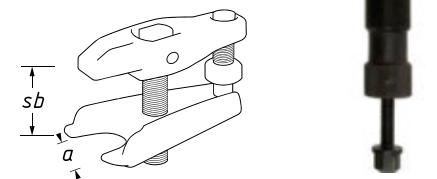

HAZET No.	a mm	sb mm	EAN-No. 4000896+	€
• Pro osobní automobily · dodávky · užitková vozidla				
• Zatížení maximálně 12 tun				
1790-5	32	70	145461	366,90
• Pro UV, autobusy a stavební stroje				
• Zatížení maximálně 12 tun				
1790-6	40	85	145478	530,-



Silentblok

4937 Sada nářadí pro silentbloky

• Výrazná časová úspora, odpadá demontáž dílů nápravy



- Použití: Bezpečné zatlačení a vytlačení drážkovaných silentbloků
- **MERCEDES-BENZ** Actros 1, 2, 3 r. v. 2002 → – uložení stabilizátoru
- Ø 70 mm: **MAN** TGA, TGS, TGX – uložení tlumiče
- Ø 68 mm: **MAN** (přední pružina) ROR, SAF – uložení tlumiče
- Ø 66 mm: **IVECO** Eurostar – kabina řidiče
- Ø 65 mm: **MERCEDES-BENZ** Actros 1 · Atego 1 · Axor 1, 2, 3 · Econic 1 – uložení stabilizátoru
- Ø 63 mm: **DAF**
- Ø 60 mm: **MAN** TAG, TGS, TGX – uložení listové pružiny VA, HA · **MERCEDES-BENZ** Actros, Axor – oko listové pružiny · **IVECO** Eurostar – oko listové pružiny · **RENAULT** Kerax, Magnum, Premium – oko listové pružiny
- Ø 58 mm: **MERCEDES-BENZ** 3229 B, 652, 650 · **Volvo**
- Ø 56 mm: **IVECO** Eurostar – kabina řidiče
- Vtažení drážkovaných silentbloků s pomocí vřetena
- Možné volitelné použití hydraulického válce (např. HAZET 4932-17)
- Bezpečná práce prostřednictvím centrování pouzdra při montáži, již není možné vzpříčení při vtačování
- Obsluha jednou osobou

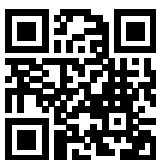

YouTube Clip

HAZET No.		EAN-No. 4000896+	€
4937-2/32	32	222957	1440,-

Kloubové hřídele

4685-1 Vyráječ výstupkových klínů

Made in Germany

- Použití: Bezpečné vyražení výstupkových klínů z ozubených kol na zemědělských strojích a rovněž ruční ovládání vstupních hřídelů na zemědělských nastavbových přístrojích



HAZET No.	l mm	EAN-No. 4000896+	€
4685-1	420	222889	42,35

4685-2 Vyráječ výstupkových klínů

Made in Germany

- Použití: Bezpečné vyražení výstupkových klínů z ozubených kol na zemědělských strojích a rovněž ruční ovládání vstupních hřídelů na zemědělských nastavbových přístrojích



HAZET No.	l mm	EAN-No. 4000896+	€
4685-2	366	222896	42,35

4937 Sada čepových klíčů pro UV

Made in Germany

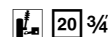

- Pro opravy a údržbu nábojů kol, kolových ložisek nebo brzdových kotoučů u vozidel **MAN**, **MERCEDES-BENZ**

- Např. pro **MAN** TGL přední náprava r. v. 2000 → a L 2000 **MERCEDES-BENZ** Atego zadní náprava HL2
- Vysoká tvarová přesnost
- Precizní geometrie čepu pro ideální záběr nástroje do matic s drážkou
- Masivní provedení: Vysoká (tvarová) stabilita i při velmi vysokých uvolňovacích a utahovacích momentech
- Čepový klíč na zadní nápravu, vnitřní Ø: 87 mm
- Délka (celková): 65 mm
- 6 čepů, šířka čepu: 10 mm
- Dvě vyměnitelné vodící trubky
Vnější Ø: 49 mm · 57 mm
délka (celkem): 140 mm

Nářadí pro manipulaci s maticemi náprav a nábojů kol u UV

- Povrch: mořeno

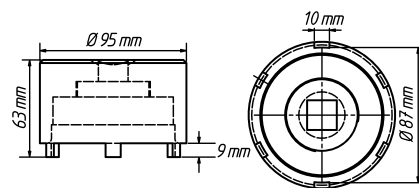

HAZET No.	l ₂ mm		EAN-No. 4000896+	€
4937-87/3	54	3	199235	354,80

Made in Germany

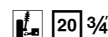

- Pro opravy a údržbu na zadní nápravě **MERCEDES-BENZ**

- Pro **MERCEDES-BENZ** Actros · hypoidní zadní náprava HL · HL 8
- Vysoká tvarová přesnost
- Precizní geometrie čepu pro ideální záběr nástroje do matic s drážkou
- Masivní provedení: Vysoká (tvarová) stabilita i při velmi vysokých uvolňovacích a utahovacích momentech
- Vnitřní Ø: 117 mm
- Délka (celková): 200 mm
- 6 čepů, šířka čepu: 9,8 mm
- Vodící trubka
vnější Ø: 60 mm
délka (celkem): 185 mm
- Povrch: mořeno

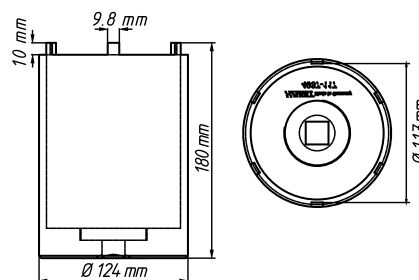

HAZET No.	l ₂ mm		EAN-No. 4000896+	€
4937-117/2	180	2	199242	360,60



Speciální nářadí

Užitková motorová vozidla (UV) – Podvozek



4937 Klíč na opouzdření kola u UV

Made in Germany

• Pro ploché oválné opouzdření kola BPW



- Pro nápravy **BPW** Eco a Eco Plus
- Perfektní tvarová kompatibilita s obrysem **BPW** Ø 110 mm
- Vysoká tvarová přesnost
- Masivní provedení: Vysoká (tvarová) stabilita i při velmi vysokých uvolňovacích a utahovacích momentech
- Povrch: mořeno

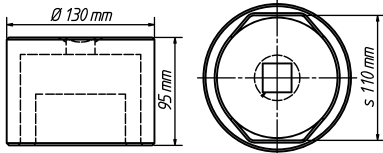

HAZET No.	l ₂ mm	EAN-No. 4000896+	€
4937-110	95	199273	240,10

4937 Nástrčný klíč pro matice náprav UV

Made in Germany

• Perfektní tvarová kompatibilita s obrysem BPW Ø 120 mm

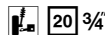

- Použití: Pro ploché oválné opouzdření kola BPW
- Vysoká tvarová přesnost
- Masivní provedení: Vysoká (tvarová) stabilita i při velmi vysokých uvolňovacích a utahovacích momentech
- Povrch: mořeno



HAZET No.	EAN-No. 4000896+	€
4937-120	210459	225,50

4937 Sada čepových klíčů pro UV

Made in Germany

• Pro opravy a údržbu nábojů kol, kolových ložisek nebo brzdových kotoučů na zadní nápravě u vozidel MAN, MERCEDES-BENZ

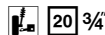

- Pro **MAN** a **MERCEDES-BENZ** 10 t a 13 t AP hypoidní a vlečená náprava N7/4 · Omnibus 0305G · 0405G
- **MAN** vnější planetová zadní náprava řady F H7 · HD7, hypoidní zadní náprava řady F HY-1175 · HDY-1175
- Vysoká tvarová přesnost
- Precizní geometrie čepu pro ideální záběr nástroje do matic s drážkou
- Masivní provedení: Vysoká (tvarová) stabilita i při velmi vysokých uvolňovacích a utahovacích momentech
- Vnitřní Ø: 103 mm
- Délka (celková): 140 mm
- 6 čepů, šířka čepu: 11,5 mm
- Dvě vyměnitelné vodící trubky vnější Ø: 51,5 mm · 66,5 mm
- Délka (celkem): 135 mm
- Povrch: mořeno



4937 Sada čepových klíčů pro UV

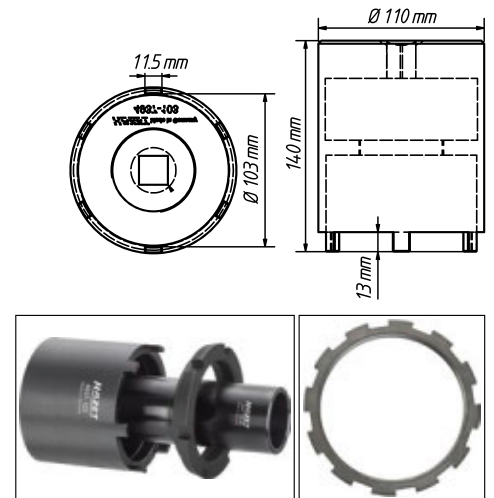
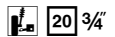

HAZET No.	€
4937-103/3	372,60

Made in Germany

• Pro demontážní/montážní práce na zadní nápravě a opravy a údržbu nábojů kol, kolových ložisek nebo brzdových kotoučů na zadní nápravě vozidel MERCEDES-BENZ

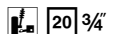

- **MERCEDES-BENZ** vnější planetová náprava, jako vlečená náprava NR7/4
- **MERCEDES-BENZ** vnější planetové nápravy (evropské nápravy) 10 t a 13 t, HL7/0 · HL7/1 · HL7/2 · HL7/3, HL7/18 · HO7/8 · HO7/9 · HL7/015, HL7/021 · HD7/2 · HD7/19DG · HD7/016DG
- **MERCEDES-BENZ** vnější planetová náprava 7 t AL7/1
- Vysoká tvarová přesnost
- Precizní geometrie čepu pro ideální záběr nástroje do matic s drážkou
- Masivní provedení: Vysoká (tvarová) stabilita i při velmi vysokých uvolňovacích a utahovacích momentech
- Vnitřní Ø: 101,5 mm
- Délka (celková): 140 mm
- 12 čepů, šířka čepu: 11,4 mm
- Tři vyměnitelné vodící trubky vnější Ø: 50 · 51 · 53 mm
- Délka (celkem): 85 mm
- Povrch: mořeno

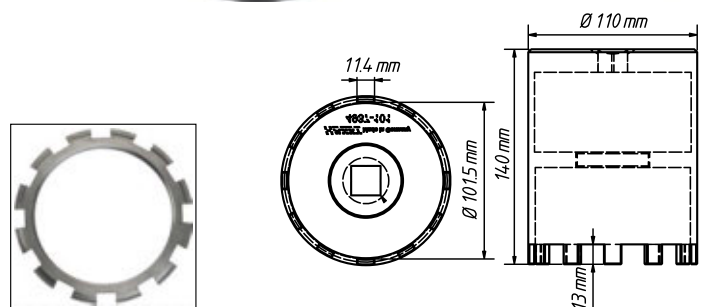

HAZET No.	€
4937-101/4	434,10



4937 Čepové klíče pro UV

Made in Germany

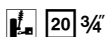

• Na zadní nápravu MERCEDES-BENZ

- Pro matice zadní nápravy MERCEDES-BENZ Actros · Atego (těžké provedení): LN2 · SK zadní náprava: 740,0/9 - 744.8 - 745.7 - 747.7 - 748.2 HD 7/19 DG 13 · HD4/16-1
- S vnější vodící přírubou
- Vysoká tvarová přesnost
- Precizní geometrie čepu pro ideální záběr nástroje do čepových matic
- Masivní provedení: Vysoká (tvarová) stabilita i při velmi vysokých uvolňovacích a utahovacích momentech
- Vnitřní Ø: 62,8 / 70 mm
- 6 čepů, šířka čepu: 7,5 mm
- Povrch: mořeno

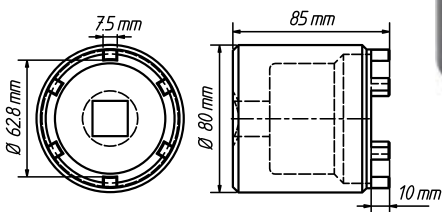

HAZET No.	l mm	EAN-No. 4000896+	€
4937-62	85	199020	294,60

4937 Nástrčný klíč na axiální matice pro UV

Made in Germany

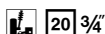

• Demontáž/montáž matice přední nápravy s 8hranem před brzdovým kotoučem

- SCANIA konstrukční řada R · konstrukční řada 4 · konstrukční řada 124 I - 144 I - atd.
- Vhodný pro rázové utahovky, např. HAZET 9013M · 9013TT
- Vysoká tvarová přesnost
- Souběžné plochy pro perfektní silový styk na axiálních maticích
- Masivní provedení: Vysoká (tvarová) stabilita i při velmi vysokých uvolňovacích a utahovacích momentech
- s 80 mm 8hr.
- Pro strojní manipulaci
- Povrch: mořeno

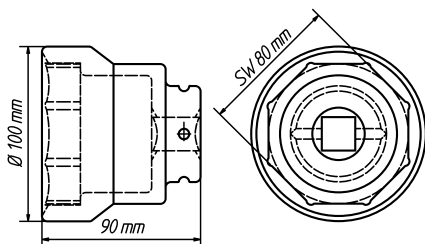

HAZET No.	l mm	EAN-No. 4000896+	€
4937-80	90	199006	211,70

4937 Nástrčný klíč pro matice náprav UV

Made in Germany



• Na matice náprav vyladěný nástrčný klíč zaručuje bezpečné uchopení matic náprav

- Použití: Šroubení přední nápravy u DAF konstrukční řady CF a XF
- Masivní provedení: Vysoká (tvarová) stálost i při vysokých povolovacích nebo utahovacích momentech
- DAF: CF FA · FT · FAR · FAN · FAT · FTT · FTP · FTG · FAD · FTS · FTR CF 65 FA CF 75 FA · FT · FAR · FAG · FAT · FAD CF 85 FA · FAR · FAG · FAN · FAT · FAC · FAX · FAQ · FAD · FT · FTP · FTS · FTR · FTG · FTT XF FA · FT · FAR · FTP · FAN · FTG · FTT · FAD · FAS · FAT · FAK · FTM · FAG · FAR XF 95 FA · FAD · FAK · FAN · FAR · FAS · FAT · FT · FTG · FTM · FTP · FTR · FTS · FTT XF 105 FA · FAR · FAS · FAT · FAK · FAD · FT · FTG · FTS · FTT · FTM
- Povrch: mořeno



HAZET No.	l mm	EAN-No. 4000896+	€
4937-S 80	63	206889	218,90

Made in Germany



• S vodícím okrajem

- Použití: Manipulace s maticí zadní nápravy např. na vozidle IVECO Daily 6,5 t · 7,0 t
- Nástrčný klíč plochou maticí zadní nápravy kompletně sevře, a umožní tak bezpečnou práci
- Vhodný pro rázové utahovky, např. HAZET 9013M · 9013TT s vložkou 1000S-36
- Vysoká tvarová přesnost
- Souběžné plochy pro perfektní silový styk na axiálních maticích
- Masivní provedení: Vysoká (tvarová) stabilita i při velmi vysokých uvolňovacích a utahovacích momentech
- Pohon šestihran s 36 mm
- Výstup: s 90 mm
- Pro strojní manipulaci
- Povrch: mořeno

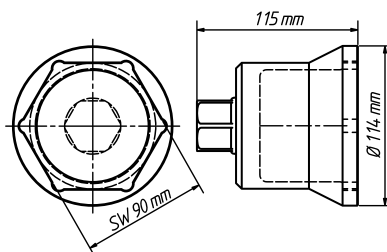

HAZET No.	l mm	EAN-No. 4000896+	€
4937-90	115	199280	345,40



Speciální nářadí

Užitková motorová vozidla (UV) – Podvozek



4937 Nástrčný klíč pro olejové uzávěry / matice náprav UV

Made in Germany

• Manipulace s olejovým uzávěrem na přední nápravě

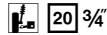

- Např. pro IVECO Stralis a Eurofire · MERCEDES-BENZ trailer Discos s kompaktním uložením HUB Unit · BPW Eco Plus 1 · BPW Eco Plus 3 · GIGANT nápravy traileru
- Vysoká tvarová přesnost
- Masivní provedení: Vysoká (tvarová) stabilita i při velmi vysokých uvolňovacích a utahovacích momentech
- Výstup: s 95 mm
- Povrch: mořeno

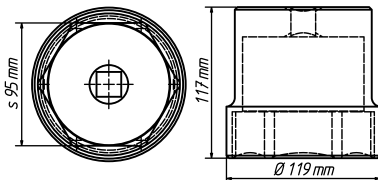

HAZET No.	l ₂ mm	EAN-No. 4000896+	€
4937-95	117	199457	237,90

4937 Sada středících pouzder pro UV

Made in Germany

• Použití: Rychlá montáž vystředěných kol se šikmou dosedací plochou u užitkových vozidel pro otvory disků o Ø 26 mm M22 x 1,5

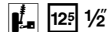

- Např. pro DAF · FORD · MAN · MERCEDES-BENZ · RENAULT · Volvo
- Bez poškození závitu a přesné vystředění disků díky kónicky natočeným objímkám
- Vysoká tvarová přesnost díky precizně zhotoveným závitům
- Vnitřní závit: M22 x 1,5 mm
- Povrch: mořeno



HAZET No.	l mm	EAN-No. 4000896+	€
4937-26/3	115	199013	106,20

4937 Montážní pouzdro pro UV MAN · závit M100 x 1,5

Made in Germany

• Montážní pouzdro pro ochranu závitu na nápravě při demontáži a montáži ložiska



- Použití u MAN TGX · TGA · TGS např. pro MAN HY 1350 náprava (13 tun) · F2000 · Lion's Star · Lion's Regio · Lion's Coach · Lion's Clasic · ND · NUE · NM · NEOPLAN Starliner · Cityliner · Centroliner · Trendliner
- Pouze jednorázové zvednutí ložiskové jednotky o hmotnosti cca 40 kg (ložisko a brzdový kotouč a náboj kola) na montážní pouzdro, poté posunutí až na sedlo ložiska s Ø 105 mm
- Závit: M100 x 1,5
- Vnější Ø: 105 mm
- Pohon přes rýhovanou plochu rukojeti nebo vhodnou příčnou tyč
- Povrch: mořeno



HAZET No.	Ø mm	EAN-No. 4000896+	€
4937-100	105	201983	268,80

4937 Sada nástrčných hlavic pro matice kol užitkových vozidel DAF · RENAULT · Volvo

Made in Germany

• Šroubovatelná vodící trubka umožňuje flexibilní použití



- □ Pohon 25 = 1", resp. ● 60 mm
- DAF s vodící trubkou
- RENAULT · Volvo bez vodící trubky
- S vnější vodící přírubou
- Ovládání rázovým utahovákem (9014 P-1 · 9014 PS-1 · 9014TT) a také momentovým klíčem (6160-1 CT · 6170-1 CT)
- Vysoká tvarová přesnost
- Masivní provedení: Vysoká (tvarová) stabilita i při velmi vysokých uvolňovacích a utahovacích momentech
- Povrch: mořeno

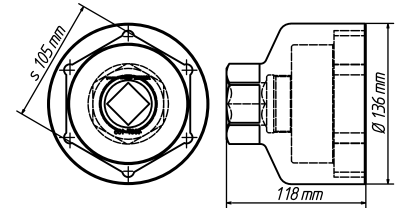

HAZET No.	l ₂ mm	EAN-No. 4000896+	€
4937-105/2	118	201938	462,30

4937 Sada čepových klíčů pro užitková vozidla pro zadní nápravu vozidel MAN

Made in Germany

• Pro MAN TGX, TGA, TGS

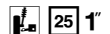

- Pro např. zadní nápravu HY 1350
- □ Pohon 25 = 1", resp. ● 60 mm
- 6 vnitřních čepů o šířce 11 mm
- Vnitřní Ø: 134,5 mm
- Vnitřní Ø (čep-čep) 118 mm
- Vnější Ø 148,5 mm
- Ovládání rázovým utahovákem (9014 P-1 · 9014 PS-1 · 9014TT) a také momentovým klíčem (6160-1 CT · 6170-1 CT)
- Vysoká tvarová přesnost
- Precizní geometrie čepu pro ideální záběr nástroje do čepových matic
- Masivní provedení: Vysoká (tvarová) stabilita i při velmi vysokých uvolňovacích a utahovacích momentech
- Povrch: mořeno

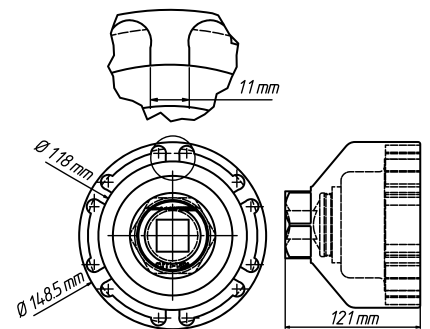

HAZET No.	l ₂ mm	EAN-No. 4000896+	€
4937-111/2	121	201945	527,-



4937 Sada středících pouzder pro UV

Made in Germany

• Pro otvor v disku \varnothing 26 mm $\frac{7}{8}$ " - 11 G např. SCANIA

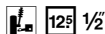

- Použití: Rychlá montáž vystředěných kol se šikmou došedací plochou u užitkových vozidel pro otvory disků o \varnothing 26 mm
- Bez poškození závitu a přesné vystředění disků díky kónicky natočeným objímkám
- Vysoká tvarová přesnost díky precizně zhotoveným závitům
- Vnitřní závit: $\frac{7}{8}$ " - 11 G
- Povrch: mořeno



HAZET No.	l mm		EAN-No. 4000896+	€
4937-27/3	115	3	202010	105,-

4937 Montážní pouzdro pro UV MERCEDES-BENZ · závit M75x1,5

Made in Germany

• Montážní pouzdro pro ochranu závitu na nápravě při demontáži a montáži ložiska



- Použití: Použití u vozidel **MERCEDES-BENZ** Atego, Atego 2, Tourino, Econic
- Pouze jednorázové zvednutí ložiskové jednotky o hmotnosti cca 40 kg (ložisko a brzdový kotouč a náboj kola) na montážní pouzdro, poté posunutí na sedlo ložiska s \varnothing 78 mm
- Závit: M75x1,5
- Vnější \varnothing : 78 mm
- Pohon možný přes příčnou tyč nebo bez dodatečného nářadí (rýhovaná plocha rukojeti)
- Povrch: mořeno



HAZET No.	\varnothing mm	EAN-No. 4000896+	€
4937-7578	78	201990	196,80

4937 Montážní pouzdro pro UV MAN · závit M75x1,5

Made in Germany

• Montážní pouzdro pro ochranu závitu na nápravě při demontáži a montáži ložiska



- Použití: Použití u vozidel **MAN** TGL, TGM, řady L, HL 2
- Pouze jednorázové zvednutí ložiskové jednotky o hmotnosti cca 40 kg (ložisko a brzdový kotouč a náboj kola) na montážní pouzdro, poté posunutí až na sedlo ložiska s \varnothing 82 mm
- Závit: M75x1,5
- Vnější \varnothing : 82 mm
- Pohon možný přes příčnou tyč nebo bez dodatečného nářadí (rýhovaná plocha rukojeti)
- Povrch: mořeno



HAZET No.	\varnothing mm	EAN-No. 4000896+	€
4937-7582	82	201969	188,-

4937 Montážní pouzdro pro UV s nápravami SAF – závit M 75x1,5 vpravo/vlevo

Made in Germany

• Montážní pouzdro pro ochranu závitu na čepu nápravy při demontáži a montáži ložiska



- Pouzdro má jak levý, tak i pravý závit M75x1,5
- Pro kotoučové a bubnové brzdy pro nápravy **SAF** s uložení ložiska \varnothing 88 mm
- Pouze jednorázové zvednutí ložiskové jednotky o hmotnosti cca 40 kg (ložisko a brzdový kotouč a náboj kola) na montážní pouzdro, poté posunutí až na sedlo ložiska s \varnothing 88 mm
- Vnější \varnothing : 88 mm
- Pohon možný přes příčnou tyč nebo bez dodatečného nářadí (rýhovaná plocha rukojeti)
- Povrch: mořeno



HAZET No.	\varnothing mm	EAN-No. 4000896+	€
4937-7588	88	202003	208,-

4937 Nástrčný klíč pro matice náprav UV

Made in Germany

• Masivní provedení: Vysoká (tvarová) stálost i při vysokých povolovacích nebo utahovacích momentech



- Manipulace s maticí nápravy např. u náprav návěsů a přívěsů **SAF** při opravách a údržbě
- Pohon šestihran s 36 mm
- Výstup: s 85 mm
- Povrch: mořeno

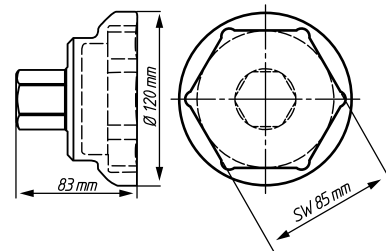

HAZET No.	l ₂ mm	EAN-No. 4000896+	€
4937-85	83	204267	254,-





Speciální nářadí

Užitková motorová vozidla (UV) – Podvozek



4937 Sada čepových klíčů pro užitková vozidla pro přední nápravu vozidel MAN

Made in Germany

• Čepové klíče MAN TGX, TGA, TGS všechny modely r. v. 2000 →

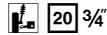

- Pro např. přední nápravu V9-82L-01 (kotoučová brzda s ABS) a zadní nápravu **MERCEDES-BENZ** Atego a různé autobusy **MAN · MERCEDES-BENZ · VAN HOOL** a **NEOPLAN**
- Vnitřní Ø: 100,5 mm
- Vnitřní Ø (čep-čep): 92,5 mm
- Vnější Ø: 114 mm
- 6 uvnitř uložených čepů o šířce 7 mm
- □ Pohon 20 = 3/4" a vnější 6hran s 46 mm
- Použití s ■ 20 = 3/4" rázovým utahovákem (9013M · 9013TT) a momentovým klíčem (6145-1 CT · 6150-1 CT)
- Vysoká tvarová přesnost
- Precizní geometrie čepu pro ideální záběr nástroje do čepových matic
- Masivní provedení: Vysoká (tvarová) stabilita i při velmi vysokých uvolňovacích a utahovacích momentech
- Uťahovací moment šroubového spoje: 750–800 Nm (respektujte údaje výrobce)
- Pro: **nákladní vozidla MAN**: E 2000 (ÖAF) · F 2000 · M 2000 L · M 2000 M **MAN TGA · TGM · TGS · TGX**
- **MAN** autobusy: Lions City · Lions Classic · Lions Coach · Lions Regio · Lions Star a starší typy (modely) · podvozky
- **NEOPLAN** Cityliner · Starliner · Tourliner · Trendliner
- **TEMSA** Diamond · **WISEON** Hochdecker
- Povrch: mořeno



HAZET No.	l _z mm	Ø mm	EAN-No. 4000896+	€
4937-92	84	114	201952	269,40

4937 Rázový očkový klíč · dvojitý šestihran se 2 nárazovými plochami

Made in Germany

• Profil s dvojitým 6hranem umožňuje nasazení i na těžko přístupné šroubové spoje

- Použití: Ovládání většinou velmi pevně usazeného šroubení kardanového hřídele i ve stísněných prostorových poměrech
- Laserem nanesený vzorec pro rychlý přepočet výrobcem zadaného utahovacího momentu
- Zvláště se hodí pro opravu na cestách, kde není k dispozici pracovní jáma
- 2 nárazové plochy umožňují cílené působení síly kladiva
- Mimořádně stabilní a extrémně zatížitelný

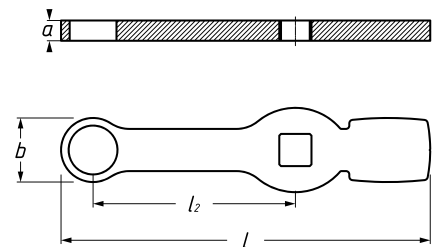

HAZET No.	l mm	a mm	b mm	EAN-No. 4000896+	€
Pro šroubení kardanových hřídelů u užitkových vozidel MERCEDES-BENZ					
4937-19	215	12	30	215645	49,40
Pro šroubení kardanových hřídelů MAN u užitkových vozidel					
4937-21	215	12	30	215638	49,40

Kola / pneumatiky

715 Křížový klíč

Made in Germany

- Pro OA, dodávky, velkoprostorové limuzíny a zemědělské stroje
- Kováný střední díl
- **Prověřen až do 500 Nm**
- S ■ 12,5 = 1/2"
- pro nástrčné hlavice série 900
- Povrch: chromováno, leštěná hlava
- DIN 3119, ISO 6788

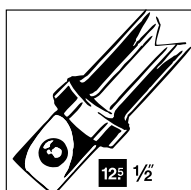

HAZET No.	S mm	l mm	EAN-No. 4000896+	€
715-01	17x19x22x12,5 1/2"	420	029464	104,-

720 Křížový klíč

Made in Germany

• Pro užitková vozidla, traktory, zemědělské a stavební stroje



- Kováný střední díl
- **Prověřen až do 2000 Nm**
- 720 S s ■ 20 = 3/4" pro nástrčné hlavice série 1000
- **Americké rozměry**
- Povrch: chromováno, leštěná hlava
- DIN 3119

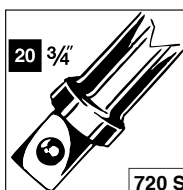

HAZET No.	S mm	l mm	EAN-No. 4000896+	€
720-30	24x27x30x32	750	029518	228,70
720 S	24x27x32x20 3/4"	750	029532	228,70



772 Univerzální sada nářadí s klíči pro matice náprav a drážkované matice

• Rozsah upnutí: 35–170 mm

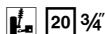

- Použití: Demontáž a přesná montáž téměř všech známých matic náprav, např. šestihranné, osmihranné, pojistné, s čelním otvorem, se dvěma otvory, s křížovými otvory atd.
- Maximální utahovací moment: 700 Nm
- Plastová skříňka
- Safety-Insert-System, 2komponentní vložka z měkké pěny. Vložka vhodná také pro HAZET-Assistent



HAZET No.		EAN-No. 4000896+	€
772-2/16	16	161041	600,-

4937 Demontážní nářadí na dvoumontáže pneumatik

• Ruční nářadí, malé působení síly



- Použití: Snadná demontáž u vnějších dvoumontáží pneumatik s těžkým chodem a také os kotoučových a bubnových brzd
- Vhodné pro všechny tahače, omnibusy, trailery a osy přívěsů
- Způsob práce:
 - Tlačné prvky pomocí vřetene prostrčit otvory ráfků
 - Vřeteno vyvine potřebnou sílu a oddělí vnější dvoumontáže pneumatik od náboje
- Obsah (4dílná sada):
 - 1 podepření kraje ráfku s uchycením vřetene (koule), Ø 44 mm
 - 1 vřeteno M24x2,0 se 6hran. pohonem s 17 mm
 - 1 tlačný prvek velikost 1 Ø 48x40 mm
 - 1 tlačný prvek velikost 2 Ø 50 mm



YouTube Clip



HAZET No.		EAN-No. 4000896+	€
4937-1/4	4	219056	165,80

Elektrický systém / servis baterií

Kontakty / konektory / vypichováky kabelů

Vypichovák KABELOVÝCH SYSTÉMŮ

- Profesionální použití
- Snadná manipulace
- Bezpečné používání
- Kvalita od přímého dodavatele – Made in Germany
- Defekty a chybné spoje lze rychle, bez námahy a profesionálně odstranit
- Univerzální použití v oblasti elektrických zařízení vozidel
- S výsuvným šoupátkem pro ochranu čepelí a proti poranění

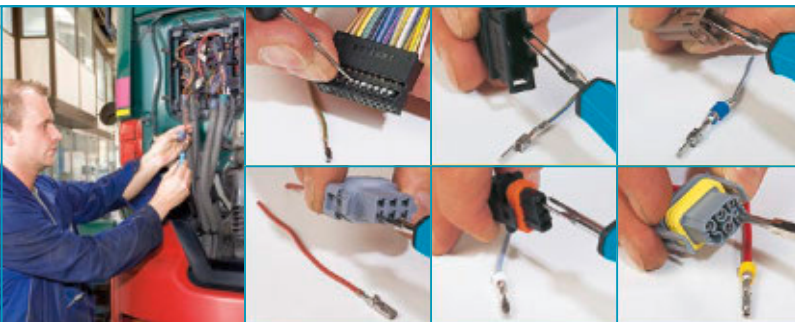

4670 Sada vypichováků KABELOVÉHO SYSTÉMU

Germany **Made in Germany**

- Použití: K vypichování konektorů bez poškození, např. plochých a válcových konektorů
- Doplnková sada pro NA/UV



4671
4671-4 • 4671-15
4671-16



4673-12



4672
4672-19 • 4672-21
4672-22



4674
4674-9 • 4674-10



HAZET No.		EAN-No. 4000896+	€
4670-6/9	9	135776	408,60



Speciální nářadí

Užitková motorová vozidla (UV) – Karoserie / vnitřní vybavení



4670 Sada vypichováků KABELOVÉHO SYSTÉMU

Made in Germany

• Zaručuje odblokování nejběžnějších kontaktů užitkových vozidel bez poškození

- Použití: K vypichování plochých konektorů bez poškození, např. pro sekundární blokování, blokování tělesa a plochých pružinových kontaktů
- **Doplňková sada pro NA/UV**

Ⓔ



1/9				
-----	--	--	--	--



4672
4672-1 • 4672-3 • 4672-4



4673
4673-1 • 4673-12

HAZET No.	d x š x v mm		EAN-No. 4000896+	€
4670-9/5	185x153x52	5	205042	203,20

Karoserie / vnitřní vybavení

2784 SLG Nástrčná hlavice pro rázový · strojový utahováč se speciálním profilem

Made in Germany

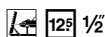

- Optimalizovaný speciální profil pro uchycení lehké matice s plochou hlavou bez poškození
- Extra dlouhé

- Použití: Manipulace s lehkou maticí se speciálním profilem u rámu, sedlové spojky, předních nosníků a tlumiče chvění **MERCEDES-BENZ** Actros · Antos · Arocs r. v. 2016 →
- Povrch: fosfátováno
- DIN 3124, ISO 2725-2



2784 S Nástrčná hlavice pro rázový · strojový utahováč se speciálním profilem

Made in Germany

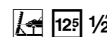

- Optimalizovaný speciální profil pro uchycení lehké matice s plochou hlavou bez poškození

- Použití: Manipulace s lehkou maticí se speciálním profilem u rámu, sedlové spojky, předních nosníků a tlumiče chvění **MERCEDES-BENZ** Actros · Antos · Arocs r. v. 2016 →
- Povrch: fosfátováno
- DIN 3124, ISO 2725-2



HAZET No.	l mm	Ø mm	d ₁ mm	d ₂ mm	t mm	EAN-No. 4000896+	€
2784 S Lg-1	75	39	38,8	30	16	218240	26,85

HAZET No.	l mm	Ø mm	d ₁ mm	d ₂ mm	t mm	EAN-No. 4000896+	€
2784 S-1	45	39	38,8	30	16	213252	17,95

2784 SR Rázový očkový klíč · dvojitý šestihran se 2 nárazovými plochami

Made in Germany

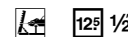

- Optimalizovaný speciální profil pro uchycení lehké matice s plochou hlavou bez poškození

- Použití: Ovládání lehkých matic se speciálním profilem na rámu, sedlové spojce, čelním nosníku a tlumiči kmitání **MERCEDES-BENZ** Actros · Antos · Arocs r. v. 2016 →
- Speciální použití v konstrukčně daných stísněných prostorech a u velmi hluboko umístěných prvků vozidel
- Povrch: fosfátováno

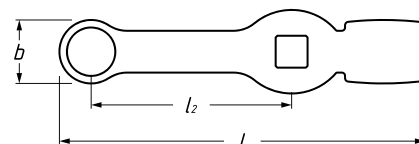

HAZET No.	l mm	l ₂ mm	a mm	b mm	EAN-No. 4000896+	€
2784 SR-1	220	120	12	41	229758	47,30

NAJDĚTE, CO JSTE HLEDALI! V NOVÉM OBCHODĚ S NÁHRADNÍMI DÍLY HAZET

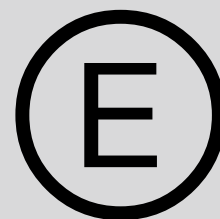

Najděte nyní vhodné
díly!

www.hazet.de/ersatzteil-shop

Jednotlivé díly (E)	HAZET No.	EAN-No. 4000896+	€
Pro skříň na nářadí 111			
• Zámek s 2 klíči Pro skříň na nářadí HAZET 111 L Dílnské vozíky HAZET Assistent 162 C · 166 N · 174	160-08 a	004294	14,90
Pro dílnský vozík 162 C			
• Zámek s 2 klíči Pro skříň na nářadí HAZET 111 L Dílnské vozíky HAZET Assistent 162 C · 166 N · 174	160-08 a	004294	14,90
• Vana na drobné součástky Pro dílnské vozíky HAZET Assistent 162 C · 166 C · 167	162 C-5	078189	13,35
• Oddělovací plechy, 5dílné pro mezipolici Pro dílnské vozíky Assistent 162 C · 166 C	162 C-6/5	120772	16,70
• Řetěz s uzávěrem řetězové skříně Pro dílnské vozíky HAZET Assistent 162 C · 166 C	162 C-01/2	079735	9,05
• Víko kompletní s pracovní plochou Pro dílnské vozíky HAZET Assistent 162 C · 166 C	162 C-010	079780	179,-
• Řídicí kolečko Ø 125 mm kompletní s brzdou Pro dílnské vozíky HAZET Assistent 162 C · 166 C	162 C-011	079865	34,60
• Sada koleček se skládá ze 2 řídicích koleček Ø 125 mm a sady diskových kol Ø 150 mm Pro 166 C	162 C-0119	079889	127,70
• Ruční tlačítko Pro dílnský vozík HAZET Assistent 162 C	162 C-080	080397	14,20
Pro dílnský vozík 162 N			
• Zámek s 2 klíči Pro skříň na nářadí HAZET 111 L Dílnské vozíky HAZET Assistent 162 C · 166 N · 174	160-08 a	004294	14,90
• Oddělovací plechy, 5dílné Pro dílnské vozíky HAZET Assistent 162 N a 166 N	160-6/5	120741	11,85
• Diskové kolečko · 125 mm Ø · kompletní Pro dílnský vozík HAZET Assistent 166 N	160-09	004300	15,95
• Dvojitě řídicí kolečko · 75 mm Ø · s brzdou · kompletní použití v párech Pro dílnský vozík HAZET Assistent 166 N	160-011	004225	23,55
• Sada koleček · se skládá ze: 2 diskových kol · 125 mm Ø · kompletní 2 dvojitých řídicích koleček · 75 mm Ø · s brzdami · kompletní Pro 166 N	160-0119	004232	70,45
• Gumová rohož pro desku stolu Pro dílnský vozík HAZET Assistent 166 N	160-012	004263	14,60

Jednotlivé díly (E)	HAZET No.	EAN-No. 4000896+	€
Pro dílnský vozík 162 N			
• Gumový profil s černou výplní pro desku stolu nebo vloženou skříňku Pro dílnský vozík HAZET Assistent 166 N	160-013	004270	13,65
• Plastové pouzdro pro spodní vloženou skříňku Pro dílnský vozík HAZET Assistent 166 N	160-15	004331	6,20
• Pouzdro s indexem pro desku stolu · kompletní Pro dílnský vozík HAZET Assistent 166 N	160-20	004348	19,25
• Pouzdro s indexem pro horní vloženou skříňku · kompletní Pro dílnský vozík HAZET Assistent 166 N	160-40	004362	14,50
• Řetěz · 31 článků · v páru Pro 166 N	160 Lg-01	004447	9,75
• Ruční tlačítko Pro dílnský vozík HAZET Assistent 162 C	162 C-080	080397	14,20
Pro dílnský vozík 166 C			
• Vana na drobné součástky Pro dílnské vozíky HAZET Assistent 162 C · 166 C · 167	162 C-5	078189	13,35
• Oddělovací plechy, 5dílné pro mezipolici Pro dílnské vozíky Assistent 162 C · 166 C	162 C-6/5	120772	16,70
• Řetěz s uzávěrem řetězové skříně Pro dílnské vozíky HAZET Assistent 162 C · 166 C	162 C-01/2	079735	9,05
• Víko kompletní s pracovní plochou Pro dílnské vozíky HAZET Assistent 162 C · 166 C	162 C-010	079780	179,-
• Řídicí kolečko Ø 125 mm kompletní s brzdou Pro dílnské vozíky HAZET Assistent 162 C · 166 C	162 C-011	079865	34,60
• Sada koleček se skládá ze 2 řídicích koleček Ø 125 mm a sady diskových kol Ø 150 mm Pro 166 C	162 C-0119	079889	127,70
• Trubkový sloupek kompletní s ručním tlačítkem a upínací tyčí Pro dílnský vozík HAZET Assistent 166 C	166 C-070	079759	83,25
• Upínací tyč kompletní s ručním tlačítkem Pro dílnské vozíky HAZET Assistent 166 C · 166 N	166 C-080	080403	15,35
Pro dílnský vozík 166 N			
• Zámek s 2 klíči Pro skříň na nářadí HAZET 111 L Dílnské vozíky HAZET Assistent 162 C · 166 N · 174	160-08 a	004294	14,90
• Oddělovací plechy, 5dílné Pro dílnské vozíky HAZET Assistent 162 N a 166 N	160-6/5	120741	11,85



Informace

Jednotlivé a náhradní díly



Jednotlivé díly (E)	HAZET No.	EAN-No. 4000896+	€
Pro dílenský vozík 166 N			
• Diskové kolečko · 125 mm Ø · kompletní Pro dílenský vozík HAZET Assistent 166 N	160-09	004300	15,95
• Dvojitě řídicí kolečko · 75 mm Ø · s brzdou · kompletní použití v párech Pro dílenský vozík HAZET Assistent 166 N	160-011	004225	23,55
• Sada koleček · se skládá ze: 2 diskových kol · 125 mm Ø · kompletní 2 dvojitých řídicích koleček · 75 mm Ø · s brzdami · kompletní Pro 166 N	160-0119	004232	70,45
• Gumová rohož pro desku stolu Pro dílenský vozík HAZET Assistent 166 N	160-012	004263	14,60
• Gumový profil s černou výplní pro desku stolu nebo vloženou skříňku Pro dílenský vozík HAZET Assistent 166 N	160-013	004270	13,65
• Plastové pouzdro pro spodní vloženou skříňku Pro dílenský vozík HAZET Assistent 166 N	160-15	004331	6,20
• Pouzdro s indexem pro desku stolu · kompletní Pro dílenský vozík HAZET Assistent 166 N	160-20	004348	19,25
• Pouzdro s indexem pro horní vloženou skříňku · kompletní Pro dílenský vozík HAZET Assistent 166 N	160-40	004362	14,50
• Řetěz · 31 článků · v páru Pro 166 N	160 Lg-01	004447	9,75
• Upínací tyč kompletní s ručním tlačítkem Pro dílenské vozíky HAZET Assistent 166 C · 166 N	166 C-080	080403	15,35
Pro dílenský vozík 167-3 (S)			
• Pevné kolečko Ø 100 mm Pro dílenské vozíky HAZET Assistent 167-3 · S · 177	177-09	151158	14,55
• Řídicí kolečko s brzdou Ø 100 mm Pro dílenské vozíky HAZET Assistent 167-3 · S · 177	177-011	151165	17,80
• Řídicí kolečko bez brzdy , Ø 100 mm Pro dílenské vozíky HAZET Assistent 167-3 · S · 177	177-0110	151172	14,45
Pro dílenský vozík 167 XXL			
• Pracovní plocha · dřevo Pro dílenský vozík HAZET Assistent 167 XXL	167 XXL-05	212811	161,-
• Madlo Pro dílenský vozík HAZET Assistent 167 XXL	167 XXL-06	212835	19,65
• Odkládací dno Pro dílenský vozík HAZET Assistent 167 XXL	167 XXL-094	212859	93,15
• Pevné kolečko Ø 125 mm Pro dílenské vozíky HAZET Assistent 167 XXL · 179 · 179 N · 179 N X	179-09	143160	16,60
• Řídicí kolečko s brzdou Ø 125 mm Pro dílenské vozíky HAZET Assistent 167 XXL · 179 · 179 N · 179 N X	179-011	143184	24,75
Pro dílenský vozík 169 N			
• Zámek s 2 klíči Pro skříň na nářadí HAZET 111 L Dílenské vozíky HAZET Assistent 162 C · 166 N · 174	160-08 a	004294	14,90
• Vodící lišty · pár Pro dílenské vozíky HAZET Assistent 174 r. v. 6/2001 → 169 N r. v. 5/2000 → a 176-1 Vodící lišta zavěšená · světlá šifka nosiče zásuvky 565 mm resp. na 173 pro bočné vytahovací uložení kompletní · v páru	169 N-07/2	080304	19,80
Pro dílenský vozík 171			
• Vodící lišty · kuličkově uložené · pár Pro dílenské vozíky HAZET Assistent 152 N · 168 N · 169 HD · 171 · 172 HD · 174 r. v. → 2000 lišta nýtovaná · světlá šifka nosiče zásuvky 545 mm kompletní · v páru	152 N-07	003501	14,90
• Zámek s 2 klíči Pro skříň na nářadí HAZET 111 L Dílenské vozíky HAZET Assistent 162 C · 166 N · 174	160-08 a	004294	14,90
• Diskové kolečko · 125 mm Ø · kompletní Pro dílenský vozík HAZET Assistent 166 N	160-09	004300	15,95
• Dvojitě řídicí kolečko · 75 mm Ø · s brzdou · kompletní použití v párech Pro dílenský vozík HAZET Assistent 166 N	160-011	004225	23,55

Jednotlivé díly (E)	HAZET No.	EAN-No. 4000896+	€
Pro dílenský vozík 171			
• Sada koleček · se skládá ze: 2 diskových kol · 125 mm Ø · kompletní 2 dvojitých řídicích koleček · 75 mm Ø · s brzdami · kompletní Pro 166 N	160-0119	004232	70,45
Pro dílenský vozík 172 HD			
• Vodící lišty · kuličkově uložené · pár Pro dílenské vozíky HAZET Assistent 152 N · 168 N · 169 HD · 171 · 172 HD · 174 r. v. → 2000 lišta nýtovaná · světlá šifka nosiče zásuvky 545 mm kompletní · v páru	152 N-07	003501	14,90
• Diskové kolečko · 160 mm Ø · kompletní Pro dílenský vozík HAZET Assistent 172 HD · 174	172-09	005710	20,40
• Řídicí kolečko · 125 mm Ø · s brzdou · kompletní Pro dílenský vozík HAZET Assistent 172 HD	172-011	005550	40,25
• Sada koleček · se skládá ze: 2 diskových koleček · Ø 160 mm · s hřídelí 20 mm Ø kompletní · 2 řídicích koleček · Ø 125 mm · s přízpusobenou upevňovací deskou a brzdami · kompletní Pro 172 HD	172-0119	005567	140,10
• Gumová rohož pro desku stolu · 755 x 375 x 2 mm Pro dílenský vozík HAZET Assistent 172 HD	172-012	005574	14,80
Pro dílenský vozík 173			
• Vodící lišty · pár Pro dílenské vozíky HAZET Assistent 174 r. v. 6/2001 → 169 N r. v. 5/2000 → a 176-1 Vodící lišta zavěšená · světlá šifka nosiče zásuvky 565 mm resp. na 173 pro bočné vytahovací uložení kompletní · v páru	169 N-07/2	080304	19,80
• Vodící lišty · pro zásuvky vpředu kompletní · v páru Pro dílenský vozík HAZET Assistent 173	173-07	089819	35,55
• Pevné kolečko · včetně šroubů · 125 mm Ø Pro dílenský vozík HAZET Assistent 173	173-09	089932	46,80
• Řídicí kolečko · s brzdou · včetně šroubů Pro dílenský vozík HAZET Assistent 173	173-011	089949	47,05
• Zámek pro příhrádku na cenné věci a cylindrický zámek pro centrální zamykání Pro dílenský vozík HAZET Assistent 173	173-013	090174	29,95
• Plastové blokovací kusy k zablokování · 5 kusů Pro dílenský vozík HAZET Assistent 173	173-017	090181	9,75
• Blokovací čep zásuvky · 5 kusů · včetně nýtů Pro dílenské vozíky HAZET Assistent 173 a 178	173-019	090198	8,40
• Aretační lišta Pro dílenský vozík HAZET Assistent 173	173-021	092741	24,25
Pro dílenský vozík 174			
• Vodící lišty · kuličkově uložené · pár Pro dílenské vozíky HAZET Assistent 152 N · 168 N · 169 HD · 171 · 172 HD · 174 r. v. → 2000 lišta nýtovaná · světlá šifka nosiče zásuvky 545 mm kompletní · v páru	152 N-07	003501	14,90
• Zámek s 2 klíči Pro skříň na nářadí HAZET 111 L Dílenské vozíky HAZET Assistent 162 C · 166 N · 174	160-08 a	004294	14,90
• Vodící lišty · pár Pro dílenské vozíky HAZET Assistent 174 r. v. 6/2001 → 169 N r. v. 5/2000 → a 176-1 Vodící lišta zavěšená · světlá šifka nosiče zásuvky 565 mm resp. na 173 pro bočné vytahovací uložení kompletní · v páru	169 N-07/2	080304	19,80
• Diskové kolečko · 160 mm Ø · kompletní Pro dílenský vozík HAZET Assistent 172 HD · 174	172-09	005710	20,40
Pro dílenský vozík 177			
• Zámek s cylindrickou vložkou s 2 klíči Pro dílenský vozík HAZET Assistent 177	177-04	151226	14,65
• Pevné kolečko Ø 100 mm Pro dílenské vozíky HAZET Assistent 167-3 · S · 177	177-09	151158	14,55



Jednotlivé díly (E)	HAZET No.	EAN-No. 4000896+	€
Pro dílenský vozík 177			
• Řídicí kolečko s brzdou Ø 100 mm Pro dílenské vozíky HAZET Assistent 167-3 · S · 177	177-011	151165	17,80
• Řídicí kolečko bez brzdy, Ø 100 mm Pro dílenské vozíky HAZET Assistent 167-3 · S · 177	177-0110	151172	14,45
• Zásuvka · plochá · včetně vedení koleček Pro dílenské vozíky HAZET Assistent 177 · 177 W	177-80	151189	63,85
• Vedení koleček · pár Pro dílenské vozíky HAZET Assistent 177 · 177 W · 178 · 178 N · 178 NK	178-07/2	143443	14,90
• Jednotlivá aretační lišta Pro dílenské vozíky HAZET Assistent 177 · 177 W · 178 · 179 · 179 W	179-056	146215	10,90
Pro dílenský vozík 178			
• Blokovací čep zásuvky · 5 kusů · včetně nýtů Pro dílenské vozíky HAZET Assistent 173 a 178	173-019	090198	8,40
• Vedení koleček · pár Pro dílenské vozíky HAZET Assistent 177 · 177 W · 178 · 178 N · 178 NK	178-07/2	143443	14,90
• Zásuvka plochá · 75 mm Pro dílenský vozík HAZET Assistent 178	178-050	146178	70,55
• Zásuvka vysoká · 160 mm Pro dílenský vozík HAZET Assistent 178	178-051	146161	94,25
• Rohový zakončovací kryt Pro dílenský vozík HAZET Assistent 178	178-093	143221	3,55
• Pevné kolečko Ø 125 mm Pro dílenské vozíky HAZET Assistent 167 XXL · 179 · 179 N · 179 N X	179-09	143160	16,60
• Řídicí kolečko s brzdou Ø 125 mm Pro dílenské vozíky HAZET Assistent 167 XXL · 179 · 179 N · 179 N X	179-011	143184	24,75
• Rozdělovací plech pro plochou zásuvku Pro dílenské vozíky HAZET Assistent 177 W · 178 · 179 · 179 W	179-055	145782	7,40
• Jednotlivá aretační lišta Pro dílenské vozíky HAZET Assistent 177 · 177 W · 178 · 179 · 179 W	179-056	146215	10,90
• Rozdělovací plech pro vysokou zásuvku Pro dílenské vozíky HAZET Assistent 178 · 179 · 179 W	179-065	146239	7,80
Pro dílenský vozík 179			
• Vodicí lišty · pár Pro dílenský vozík HAZET Assistent 179 · 179 W	179-07/2	143177	17,50
• Sada zámků Pro dílenský vozík HAZET Assistent 179-1	179-08/2	188659	59,85
• Pevné kolečko Ø 125 mm Pro dílenské vozíky HAZET Assistent 167 XXL · 179 · 179 N · 179 N X	179-09	143160	16,60
• Řídicí kolečko s brzdou Ø 125 mm Pro dílenské vozíky HAZET Assistent 167 XXL · 179 · 179 N · 179 N X	179-011	143184	24,75
• Deska pojistného čepu Pro dílenské vozíky HAZET Assistent 179 · 179 W	179-019	146208	8,25
• Zásuvka plochá · 75 mm Pro dílenské vozíky HAZET Assistent 179 · 179 W	179-050	146192	76,85
• Zásuvka vysoká · 160 mm Pro dílenský vozík HAZET Assistent 179	179-051	146185	88,80
• Rozdělovací plech pro plochou zásuvku Pro dílenské vozíky HAZET Assistent 177 W · 178 · 179 · 179 W	179-055	145782	7,40
• Jednotlivá aretační lišta Pro dílenské vozíky HAZET Assistent 177 · 177 W · 178 · 179 · 179 W	179-056	146215	10,90
• Rozdělovací plech pro vysokou zásuvku Pro dílenské vozíky HAZET Assistent 178 · 179 · 179 W	179-065	146239	7,80
Pro dílenský vozík 179 N (X)			
• Pevné kolečko Ø 125 mm Pro dílenské vozíky HAZET Assistent 167 XXL · 179 · 179 N · 179 N X	179-09	143160	16,60
• Řídicí kolečko s brzdou Ø 125 mm Pro dílenské vozíky HAZET Assistent 167 XXL · 179 · 179 N · 179 N X	179-011	143184	24,75
• Lanovod Pro dílenské vozíky HAZET Assistent r. v. → 1.8.2019: 179 N · 179 N X	179 N-01	216703	20,15

Jednotlivé díly (E)	HAZET No.	EAN-No. 4000896+	€
Pro dílenský vozík 179 N (X)			
• Aretační lišta Pro dílenské vozíky HAZET Assistent 179 N · 179 N X · 179 N XL · 179 N XXL	179 N-04	216475	27,45
• Pracovní plocha · plast Pro dílenský vozík HAZET Assistent 179 N	179 N-05	216710	31,75
• Krytka Pro dílenské vozíky HAZET Assistent 179 N · 179 N X · 179 N XL · 179 N XXL	179 N-05 K	216666	6,40
• Madlo Pro dílenský vozík HAZET Assistent 179 N	179 N-06	216468	21,20
• Teleskopické lišty · pár Pro dílenské vozíky HAZET Assistent 179 N · 179 N W · 179 N X	179 N-07/2	216697	20,30
• Zámek s cylindrickou vložkou s 2 klíči Pro dílenské vozíky HAZET Assistent r. v. → 1.8.2019: 179 N · 179 N X · 179 N XL · 179 N XXL	179 N-08	217311	41,40
• Zajišťovací hák zásuvky Pro dílenské vozíky HAZET Assistent 179 N · 179 N W · 179 N X · 179 N XL · 179 N XXL	179 N-019	216635	6,65
• Zásuvka · plochá Pro dílenské vozíky HAZET Assistent 179 N · 179 N W · 179 N X	179 N-050	216659	84,40
• Zásuvka · vysoká Pro dílenské vozíky HAZET Assistent 179 N · 179 N X	179 N-051	216642	81,55
• Profil zásuvkové úchytky Pro dílenské vozíky HAZET Assistent 179 N · 179 N W · 179 N X	179 N-057	216628	7,40
• Chránič hran dole s nápisem „Made in Germany“ Pro dílenské vozíky HAZET Assistent r. v. → 1.5.2019: 179 N · 179 N W · 179 N X · 179 N XL · 179 N XXL	179 N-093	216680	8,50
• Chránič hran nahoře s nápisem „HAZET“ Pro dílenské vozíky HAZET Assistent r. v. → 1.5.2019: 179 N · 179 N X · 179 N XL · 179 N XXL	179 N-094	216673	8,50
• Krycí deska nerez Pro dílenský vozík HAZET Assistent · 179 N X	179 N X-05	217298	137,60
• Plastový kryt Pro dílenské vozíky HAZET Assistent 179 N X · 179 N XL · 179 N XXL	179 N X-05 G	217304	39,55
• Plastový kryt Pro dílenské vozíky HAZET Assistent 179 N X · 179 N XL · 179 N XXL	179 N X-05 R	217328	39,55
• Nerezové madlo Pro dílenské vozíky HAZET Assistent 179 N X · 179 N XL · 179 N XXL	179 N X-06	216727	26,50
Pro dílenský vozík 179 XL			
• Krycí deska Pro dílenský vozík HAZET Assistent 179 XL	179 XL-05	181292	156,50
• Plastový kryt · strana madla Pro dílenské vozíky HAZET Assistent 179 A XXL · 179 T XXL · 179 XL · 179 XXL	179 XL-05 G	181308	61,10
• Zámek s cylindrickou vložkou s 2 klíči Pro dílenské vozíky HAZET Assistent 178 N · 178 NK · 179 XL · 179 XXL	179 XL-08	181124	41,40
• Deska pojistného čepu pro dílenské vozíky HAZET Assistent 179 A XXL · 179 T XXL · 179 XL · 179 XXL	179 XL-019	181278	31,10
• Plastový kryt s logem Pro dílenské vozíky HAZET Assistent 179 · 179 A XXL · 179 T XXL · 179 XL · 179 XXL	179 XL-045 L	181285	61,15
• Zásuvka plochá Včetně teleskopických lišt Pro dílenský vozík HAZET Assistent 179 XL	179 XL-050	181254	115,30
• Zásuvka vysoká Včetně teleskopických lišt Pro dílenské vozíky HAZET Assistent 179 XL	179 XL-051	181247	154,10
Pro dílenský vozík 179 N XL			
• Aretační lišta Pro dílenské vozíky HAZET Assistent 179 N · 179 N X · 179 N XL · 179 N XXL	179 N-04	216475	27,45
• Krytka Pro dílenské vozíky HAZET Assistent 179 N · 179 N X · 179 N XL · 179 N XXL	179 N-05 K	216666	6,40
• Zámek s cylindrickou vložkou s 2 klíči Pro dílenské vozíky HAZET Assistent r. v. → 1.8.2019: 179 N · 179 N X · 179 N XL · 179 N XXL	179 N-08	217311	41,40
• Zajišťovací hák zásuvky Pro dílenské vozíky HAZET Assistent 179 N · 179 N W · 179 N X · 179 N XL · 179 N XXL	179 N-019	216635	6,65



Informace

Jednotlivé a náhradní díly



Jednotlivé díly (E)	HAZET No.	EAN-No. 4000896+	€
Pro dílenský vozík 179 N XL			
• Chránič hran dole s nápisem „Made in Germany“ Pro dílenské vozíky HAZET Assistant r. v. → 1.5.2019: 179 N · 179 N W · 179 N X · 179 N XL · 179 N XXL	179 N-093	216680	8,50
• Chránič hran nahoře s nápisem „HAZET“ Pro dílenské vozíky HAZET Assistant r. v. → 1.5.2019: 179 N · 179 N X · 179 N XL · 179 N XXL	179 N-094	216673	8,50
• Plastový kryt Pro dílenské vozíky HAZET Assistant 179 N X · 179 N XL · 179 N XXL	179 N X-05 G	217304	39,55
• Plastový kryt Pro dílenské vozíky HAZET Assistant 179 N X · 179 N XL · 179 N XXL	179 N X-05 R	217328	39,55
• Nerezové madlo Pro dílenské vozíky HAZET Assistant 179 N X · 179 N XL · 179 N XXL	179 N X-06	216727	26,50
• Lanovod Pro dílenský vozík HAZET Assistant r. v. → 1.8.2019: 179 N XL	179 N XL-01	216802	24,15
• Krycí deska nerez Pro dílenský vozík HAZET Assistant 179 N XL	179 N XL-05	217281	148,20
• Teleskopické lišty · pár Pro dílenské vozíky HAZET Assistant 179 N W · 179 N XL · 179 N XXL	179 N XL-07/2	216789	60,35
• Zásuvka · plochá Pro dílenský vozík HAZET Assistant 179 N XL	179 N XL-050	217267	120,70
• Zásuvka · vysoká Pro dílenský vozík HAZET Assistant 179 N XL	179 N XL-051	217250	158,90
• Profil zásuvkové úchytky Pro dílenský vozík HAZET Assistant 179 N XL	179 N XL-074	216826	11,-
• Pevné kolečko Ø 125 mm Pro dílenské vozíky HAZET Assistant 179 A XXL · 179 T XXL · 179 XL · 179 XXL · 179 N W · 179 N XL · 179 N XXL	179 W-09	146666	30,45
• Řídicí kolečko s brzdou Ø 125 mm Pro dílenské vozíky HAZET Assistant 179 A XXL · 179 XL · 179 XXL · 179 N XL · 179 N XXL · 179 T XXL · 179 N W	179 W-011	146659	42,35
Pro dílenský vozík 179 XXL			
• Zásuvka plochá · v 5/3 šířce Včetně teleskopických lišt Pro dílenské vozíky HAZET Assistant 179 A XXL · 179 T XXL · 179 XXL	179 XXL-050	181346	110,-
• Zásuvka vysoká · v 5/3 šířce Včetně teleskopických lišt Pro dílenský vozík HAZET Assistant 179 XXL	179 XXL-051	181353	166,50
• Ozdobná lišta · pro zásuvku 5/3 Pro dílenské vozíky HAZET Assistant 179 A XXL · 179 T XXL · 179 XXL	179 XXL-092	181339	41,25
Pro dílenský vozík 179 N XXL			
• Aretační lišta Pro dílenský vozík HAZET Assistant 179 N · 179 N X · 179 N XL · 179 N XXL	179 N-04	216475	27,45
• Krytka Pro dílenské vozíky HAZET Assistant 179 N · 179 N X · 179 N XL · 179 N XXL	179 N-05 K	216666	6,40
• Zámek s cylindrickou vložkou s 2 klíči Pro dílenské vozíky HAZET Assistant r. v. → 1.8.2019: 179 N · 179 N X · 179 N XL · 179 N XXL	179 N-08	217311	41,40
• Zajišťovací hák zásuvky Pro dílenské vozíky HAZET Assistant 179 N · 179 N W · 179 N X · 179 N XL · 179 N XXL	179 N-019	216635	6,65
• Chránič hran dole s nápisem „Made in Germany“ Pro dílenské vozíky HAZET Assistant r. v. → 1.5.2019: 179 N · 179 N W · 179 N X · 179 N XL · 179 N XXL	179 N-093	216680	8,50
• Chránič hran nahoře s nápisem „HAZET“ Pro dílenské vozíky HAZET Assistant r. v. → 1.5.2019: 179 N · 179 N X · 179 N XL · 179 N XXL	179 N-094	216673	8,50
• Plastový kryt Pro dílenské vozíky HAZET Assistant 179 N X · 179 N XL · 179 N XXL	179 N X-05 G	217304	39,55
• Plastový kryt Pro dílenské vozíky HAZET Assistant 179 N X · 179 N XL · 179 N XXL	179 N X-05 R	217328	39,55
• Nerezové madlo Pro dílenské vozíky HAZET Assistant 179 N X · 179 N XL · 179 N XXL	179 N X-06	216727	26,50

Jednotlivé díly (E)	HAZET No.	EAN-No. 4000896+	€
Pro dílenský vozík 179 N XXL			
• Teleskopické lišty · pár Pro dílenské vozíky HAZET Assistant 179 N W · 179 N XL · 179 N XXL	179 N XL-07/2	216789	60,35
• Lanovod Pro dílenský vozík HAZET Assistant r. v. → 1.8.2019: 179 N XXL	179 N XXL-01	216796	26,30
• Krycí deska nerez Pro dílenský vozík HAZET Assistant 179 N XXL	179 N XXL-05	217274	158,80
• Zásuvka · plochá Pro dílenský vozík HAZET Assistant 179 N XXL	179 N XXL-050	217243	131,60
• Zásuvka · vysoká Pro dílenský vozík HAZET Assistant 179 N XXL	179 N XXL-051	217236	170,-
• Profil zásuvkové úchytky Pro dílenský vozík HAZET Assistant 179 N XXL	179 N XXL-091	216819	13,20
• Pevné kolečko Ø 125 mm Pro dílenské vozíky HAZET Assistant 179 A XXL · 179 T XXL · 179 XL · 179 XXL · 179 N W · 179 N XL · 179 N XXL	179 W-09	146666	30,45
• Řídicí kolečko s brzdou Ø 125 mm Pro dílenské vozíky HAZET Assistant 179 A XXL · 179 XL · 179 XXL · 179 N XL · 179 N XXL · 179 T XXL · 179 N W	179 W-011	146659	42,35
Pro dílenský vozík 179 T XXL			
• Sada zámku Pro dílenské vozíky HAZET Assistant 179 N W · 179 T XXL	179 T XXL-08/2	181438	69,40
• Zásuvka plochá · v 3/3 šířce Pro dílenské vozíky HAZET Assistant 179 A XXL · 179 T XXL	179 T XXL-050	181551	105,40
• Zásuvka vysoká · v 3/3 šířce Pro dílenské vozíky HAZET Assistant 179 A XXL · 179 T XXL	179 T XXL-051	181384	154,30
• Zásuvka · střední v 3/3 šířce Pro dílenské vozíky HAZET Assistant 179 A XXL · 179 T XXL	179 T XXL-052	181377	126,10
Pro pracovní stůl 177 W			
• Zásuvka · plochá · včetně vedení koleček Pro dílenské vozíky HAZET Assistant 177 · 177 W	177-80	151189	63,85
• Vedení koleček · pár Pro dílenské vozíky HAZET Assistant 177 · 177 W · 178 · 178 N · 178 NK	178-07/2	143443	14,90
• Rozdělovací plech pro plochou zásuvku Pro dílenské vozíky HAZET Assistant 177 W · 178 · 179 · 179 W	179-055	145782	7,40
• Jednotlivá aretační lišta Pro dílenské vozíky HAZET Assistant 177 · 177 W · 178 · 179 · 179 W	179-056	146215	10,90
Pro pracovní stůl 179 W			
• Vodící lišty · pár Pro dílenský vozík HAZET Assistant 179 · 179 W	179-07/2	143177	17,50
• Deska pojistného čepu Pro dílenské vozíky HAZET Assistant 179 · 179 W	179-019	146208	8,25
• Zásuvka plochá · 75 mm Pro dílenské vozíky HAZET Assistant 179 · 179 W	179-050	146192	76,85
• Rozdělovací plech pro plochou zásuvku Pro dílenské vozíky HAZET Assistant 177 W · 178 · 179 · 179 W	179-055	145782	7,40
• Jednotlivá aretační lišta Pro dílenské vozíky HAZET Assistant 177 · 177 W · 178 · 179 · 179 W	179-056	146215	10,90
• Rozdělovací plech pro vysokou zásuvku Pro dílenské vozíky HAZET Assistant 178 · 179 · 179 W	179-065	146239	7,80
Pro pracovní stůl 179 N W			
• Teleskopické lišty · pár Pro dílenské vozíky HAZET Assistant 179 N · 179 N W · 179 N X	179 N-07/2	216697	20,30
• Zajišťovací hák zásuvky Pro dílenské vozíky HAZET Assistant 179 N · 179 N W · 179 N X · 179 N XL · 179 N XXL	179 N-019	216635	6,65
• Zásuvka · plochá Pro dílenské vozíky HAZET Assistant 179 N · 179 N W · 179 N X	179 N-050	216659	84,40
• Profil zásuvkové úchytky Pro dílenské vozíky HAZET Assistant 179 N · 179 N W · 179 N X	179 N-057	216628	7,40



Jednotlivé díly (E)	HAZET No.	EAN-No. 4000896+	€
Pro pracovní stůl 179 N W			
• Chránič hran dole s nápisem „Made in Germany“ Pro dílenské vozíky HAZET Assistent r. v. → 1.5.2019: 179 N · 179 N W · 179 N X · 179 N XL · 179 N XXL	179 N-093	216680	8,50
• Aretační lišta Pro dílenský vozík HAZET Assistent 179 N W	179 N W-04	220151	36,05
• Pracovní plocha · dřevo Pro dílenský vozík HAZET Assistent 179 N W	179 N W-05	220175	242,40
• Magnetická západka včetně 2 šroubů Pro dílenský vozík HAZET Assistent 179 N W	179 N W-012	220182	9,60
• Dveře , uzamykatelné, včetně závěsů (2x), profil rukojeti Pro dílenský vozík HAZET Assistent 179 N W	179 N W-21	220168	157,80
• Zásuvka · vysoká Pro dílenský vozík HAZET Assistent 179 N W	179 N W-051	220144	140,80
• Chránič hran nahoře s nápisem „HAZET“ Pro dílenský vozík HAZET Assistent r. v. → 1.5.2019: 179 N W	179 N W-094	220137	9,05
• Teleskopické lišty · pár Pro dílenský vozík HAZET Assistent 179 N W · 179 N XL · 179 N XXL	179 N XL-07/2	216789	60,35
• Sada zámku Pro dílenský vozík HAZET Assistent 179 N W · 179 T XXL	179 T XXL-08/2	181438	69,40
• Pevné kolečko Ø 125 mm Pro dílenský vozík HAZET Assistent 179 A XXL · 179 T XXL · 179 XL · 179 XXL · 179 N W · 179 N XL · 179 N XXL	179 W-09	146666	30,45
• Řídicí kolečko s brzdou Ø 125 mm Pro dílenský vozík HAZET Assistent 179 A XXL · 179 XL · 179 XXL · 179 N XL · 179 N XXL · 179 T XXL · 179 N W	179 W-011	146659	42,35
Různé jednotlivé díly – provozní a dílenské zařízení			
• Přísavka pro 161-8 · kompletní se šrouby · podložkou a těsněním	161-81	004850	25,35
Pro pojízdné lehátko 195-2			
• Náhradní kolečka · 2 ks Pro pojízdné lehátko HAZET 195-2	195-02/2	162499	23,60
Pro gumovou podložku 196 VDE			
• Taška pro gumovou podložku HAZET 196 VDE-8	196-8 TL	173921	82,80
Různé jednotlivé díly			
• Svirací držák prázdný pro 450 N/8 RS a 610 N/8 RS	450 N/8 RS L	020294	18,50
• Svirací držák prázdný pro 450 N/12 RS · 450 N/12 N RS · 610 N/12 RS	450 N/12 RS L	020270	37,50
• Plastový díl se šrouby pro 650 K-20	650 K-020/6	028689	11,35
• Plastová nárazová hlava pro 665-1 a 665-2	665-01	029211	6,-
• Ochranný kryt na plochý sekáč HAZET 730-6 · 7 · 8	730 HS	029631	8,75
• Z nárazuvzdorného plastu			
• Hrot důlkovače pro 747-1	747-02	051380	18,70
• Napínací pás Pro napínací kleště písních kroužků HAZET 794 U-3	794 U-301	031689	17,50
• Segment s kluzným pásem Pro napínací kleště písních kroužků HAZET 794 U-3	794 U-303	031702	14,65
• Sada náhradních dílů se skládá ze: 2 přídržných čepů · 2 pojistných podložek pro 798	798-0/4	031849	10,45
798-1	798-01/4	031856	11,70
798-3	798-03/6	107513	16,85
798-5	798-05/4	031894	15,35
798-10	798-010/4	031863	26,05
798-6 · 798-8 · 798-12	798-012/4	031870	26,05
• Lankové táhlo · kompletní s upevňovacími prvky 2x matice M4 pro 798-15	798-0151	082254	39,20
• Lankové táhlo pro 798-15	798-0152	082247	14,50
• Lankové táhlo · kompletní Lankové táhlo · opláštění · 2 stavěcí šrouby · pružina pro 798-15 A	798-0151 A	097753	39,20
• Flexibilní hadice pro 798-15 B	798-0150 B	142439	47,90
• Lankové táhlo pro 798-15 A a B	798-0152 A	097760	14,50

Jednotlivé díly (E)	HAZET No.	EAN-No. 4000896+	€
Různé jednotlivé díly			
• Posuvné vedení pro 798-15 A a B	798-0153 A	097784	21,60
• Sada náhradních břitů pro 822 5 kusů v sadě	822-01/5	033720	32,85
• Otočná řezná destička z tvrdokovu pro 825-25	825-025	033928	58,70
• Náhradní sekáč pro mechanický trhač matic HAZET 847-0410 A a 1027 A	847-10 A	144150	28,-
Pro přepínací ráčnu atd.			
• Sada náhradních dílů ovládací páky obsah sady: ovládací páka · fixační prvek · šrouby · kulička · tlačná pružina Pro přepínací ráčny HAZET 863 K · 863 G · 863 P · 863 PC · 863 Q · 863 S · 863 ST · 863 BGL · 863 BKC · 863 BK · 863 MC · 863 Mbit · 2264	863 P/6	144600	7,40
• Sada náhradních dílů kolečka ráčny 6,3 = ¼" ■, obsah sady: kolečko ráčny · fixační prvek · ovládací páka · šrouby · kulička · tlačná pružina Pro přepínací ráčnu HAZET 863 G · 863 P · 863 PC · 863 ST · 863 K · 863 MC	863 P/7 N	038596	17,45
• Sada náhradních dílů kolečka ráčny 6,3 = ¼" ■, obsah sady: kolečko ráčny se spouštěcím tlačítkem · fixační prvek · ovládací páka · šrouby · kulička · tlačná pružina Pro přepínací ráčnu HAZET 863 Q · 863 S a k přestavení přepínací ráčny HAZET 863 P · 863 PC · 863 G · 863 ST · 863 K · 863 MC	863 S/7	048472	24,15
• Korunková pružina pro klíč na zapalovací svíčky HAZET 880 KF · 900 KF · 4767 KF	880 KF-01	050123	2,50
• Korunková pružina pro klíč na zapalovací svíčky HAZET 880 A KF · 900 A KF · 4766 · 4766-1 · 4767 A KF	880 A KF-01	050130	2,50
• Sada náhradních dílů ovládací páky obsah sady: ovládací páka · šrouby · kulička · tlačná pružina · fixační prvek Pro přepínací ráčnu HAZET 8816 G · 8816 GK · 8816 P · 8816 S · 8816 ST 916 K · 2264-1 Pro momentový klíč HAZET 5110-2 CT · 5120-2 CT · 5110-3 CT · 5111-3 CT · 5120-3 CT 6110 CT · 6110-1 CT · 6111-1 CT 6114-1 CT · 6115-1 CT 6402-1 · 6402-1 S · 6408-1	8816 P/6	144617	8,15
• Sada náhradních dílů kolečka ráčny 10 = ¾" ■, obsah sady: kolečko ráčny · fixační prvek · ovládací páka · šrouby · kulička · tlačná pružina Pro přepínací ráčnu HAZET 8816 G · 8816 GK · 8816 P · 8816 ST Pro momentové klíče HAZET 5110-2 CT · 5110-3 CT · 5111-3 CT 6110 CT · 6110-1 CT · 6111-1 CT 6114-1 CT · 6115-1 CT · 6402-1	8816 P/7 N	042234	20,85
• Sada náhradních dílů kolečka ráčny 10 = ¾" ■, obsah sady: kolečko ráčny se spouštěcím tlačítkem · fixační prvek · ovládací páka · šrouby · kulička · tlačná pružina Pro přepínací ráčnu HAZET 8816 G · 8816 GK · 8816 ST · 6110 CT · 6110-1 CT · 6111-1 CT · 6114-1 CT · 6115-1 CT · 6402-1	8816 S/7	048465	30,90
• Plastová rukojeť Pro HAZET 8814 · 8816 P · 8816 F · 8816 G · 8816 GK · 2593 Lg-17	8816 KG-02	042166	2,40
• Náhradní sada kloubového spojení se skládá z/ze: šroubu a pružného kroužku Pro kloubovou rukojeť HAZET 8814 a přepínací ráčnu HAZET 8816 G · 8816 GK	8816 G-013	042111	4,25
• Sada náhradních dílů se skládá z/ze: sklopného kusu · šroubů a pružného kroužku Pro kloubovou rukojeť HAZET 914-15 a 914-18	914/3	046065	16,25
• Náhradní sada kloubového spojení se skládá z/ze: šroubu a pružného kroužku Pro kloubovou rukojeť HAZET 914-15 · 914-18 a přepínací ráčnu HAZET 916 GK	916 G-013	046188	4,10
• Plastová rukojeť Pro HAZET 916 F · 916 SP · 2574 · 2574-1	916 KG-02	046225	5,95
• Plastová rukojeť Pro HAZET 771 A-13/16 · 771-17 · 771-19 · 771-21 · 772 914-15 · 914-18 · 916 GK	916 KG-04	046249	5,95



Informace

Jednotlivé a náhradní díly



Jednotlivé díly (E)	HAZET No.	EAN-No. 4000896+	€
Pro přepínací ráčnu atd.			
• Sada náhradních dílů kolečka ráčny 12,5 = 1/2" ■, obsah sady: ovládací páka · 2 šrouby · kulička · tlačná pružina · kolečko ráčny se spouštěcím tlačítkem a fixační prvek Pro přepínací ráčnu HAZET 916 S a k přestavení přepínací ráčny HAZET 916 SP · 916 GK · 916 L · 916 ST	916 S/7	046300	36,80
• Sada náhradních dílů ovládací páky 12,5 = 1/2" ■, obsah sady: ovládací páka · 2 šrouby · kulička a tlačná pružina a fixační prvek Pro přepínací ráčnu HAZET 916 S · 916 SP · 916 GK · 916 Lg · 916 L · 916 GL · 916 ST	916 SP/6	144624	10,75
• Sada náhradních dílů kolečka ráčny 12,5 = 1/2" ■, obsah sady: ovládací páka · šrouby · kulička · tlačná pružina · kolečko ráčny a fixační prvek Pro přepínací ráčnu HAZET 916 SP · 916 GK · 916 Lg · 916 L · 916 GL · 916 ST	916 SP/7-1	046348	24,20
• Sada náhradních dílů kolečka ráčny · 12,5 = 1/2" ■, obsah sady: ovládací páka · šrouby · kulička · tlačná pružina · kolečko ráčny a fixační prvek Pro přepínací ráčnu HAZET 916 K	916 K/7	155743	20,85
• Sada náhradních dílů ovládací páky obsah sady: ovládací páka · šrouby · kulička · tlačná pružina Pro přepínací ráčnu HAZET 1016 · 1016/2 Pro momentový klíč HAZET 5145-3 CT · 6132-1 CT · 6143 CT · 6143-1 CT · 6144 CT · 6144-1 CT · 6145 CT · 6145-1 CT · 6146-1 CT	1016/6	001972	3,85
• Sada náhradních dílů kolečka ráčny 20 = 3/4" ■, obsah sady: kolečko ráčny · fixační prvek · ovládací páka · šrouby · kulička · tlačná pružina Pro přepínací ráčnu HAZET 1016 · 1016/2 Pro momentové klíče HAZET 5145-3 CT · 6132-1 CT · 6143 CT · 6143-1 CT · 6144 CT · 6144-1 CT · 6145 CT · 6145-1 CT · 6146-1 CT	1016/8 N	001989	55,-
• Vtlačovací čtyřhran pro adaptér HAZET 1058-2	1058-02 A	233557	7,30
• Sada náhradních dílů ovládací páky obsah sady: ovládací páka · šrouby · kulička · tlačná pružina Pro přepínací ráčnu HAZET 1116 Pro momentové klíče HAZET 6150-1 CT · 6160-1 CT · 6170-1 CT · 7250-2 sTAC · 7250-5 sTAC	1116/6	003228	5,-
• Sada náhradních dílů kolečka ráčny 25 = 1" ■, obsah sady: ovládací páka · šrouby · kulička · tlačná pružina · fixační prvek · kolečko ráčny Pro přepínací ráčnu HAZET 1116 Pro momentové klíče HAZET 6160-1 CT · 6170-1 CT	1116/8 N	003235	65,90
Pro program vytahovacího nářadí			
• Stahovací hák 170 mm	1777-03	134281	29,-
• Vřeteno M 14 x 1,5 x 140 Pro stahovák HAZET 1786 F-9 · 13 · 1786 S-1 · 1786 S/2 · 1786 FS/6 · 1787 F-9 · 13 · 1787 S-1	1786-01	134724	18,25
• Vřeteno G1/2 x 210 pro 1786 F-16 · 20 · 1786 S-2 · 1787 F-16 · 20 · 1787 S-2	1786 S-03	134793	29,75
• Vřeteno G1/2 x 210 pro 1786 F-16 · 20 · 1786 S-2 · 1787 F-16 · 20 · 1787 S-2	1786 S-03	134793	29,75
Různé jednotlivé díly			
• Teleskopická pružina pro 1805-3 · 1806-1 až -4	1806-01	006175	2,15
• Výměnné hroty · 90° zahnuté Pro výměnu u kleští 1846 a-5	1846 b-05/2	081318	19,15
• Výměnné hroty · 90° zahnuté Pro výměnu u kleští 1846 c-5	1846 d-05/2	081370	19,15
• Sada náhradních dílů se skládá z: 1 páru razících čelistí · 15 mm širokých · 2 šroubů a 2 upínacích pouzder Pro 1932-1 · -2 · -5	1932-1/6	007820	12,05
• Sada náhradních dílů se skládá z: 1 páru razících čelistí · 30 mm širokých · 2 šroubů a 2 upínacích pouzder Pro 1932-1 · -2 · -5	1932-2/6	007905	16,-
• Náhradní hlavy · pár pro plastové šetné kladívko HAZET 1952-28	1952-028	008391	5,65
1952-35	1952-035	008414	7,75

Jednotlivé díly (E)	HAZET No.	EAN-No. 4000896+	€
Různé jednotlivé díly			
• Náhradní hlavy · pár pro plastové šetné kladívko HAZET 1952-40	1952-040	008438	10,05
1952-50	1952-050	008452	14,25
• Sada náhradních dílů se skládá z: 1 rukojeti a 2 šroubů s válcovou hlavou Pro 1959-3 a -4	1959-03/3	008711	32,75
• Sada náhradních dílů se skládá z: rukojeti 1963-015 pro kryt · 1963-016 pro ramínko	1963/02	008964	14,65
• Čelisti sklíčidla · 2dílné pro 1963	1963-05	008957	14,90
• Náhradní korunky, sada po 5 ks, pro 1967	1967-01/5	211319	52,40
• Hrot pro frézu svarových bodů HAZET 1967	1967-02	009336	3,85
• Zrcátko a 2 žárovky pro kontrolní zrcátko HAZET 1977-1	1977-01/3	009794	33,35
• Náhradní žárovka pro kontrolní zrcátko HAZET 1977-1	1977-02	070442	9,50
• Náhradní žárovka pro ohebné světlo HAZET 1977-1	1978-01	076154	16,40
• Světelná jednotka pro 1979-6	1979-6-02	173808	119,60
• Háč pro 1979-6	1979-6-03	173815	3,75
• Náhradní akumulátor pro 1979-6	1979-6-05	173822	77,65
• Pojistka pro 1979-6	1979-6-07	173846	4,80
• Pilový list z chromem legované nástrojové oceli pro 1981	1981-01	009848	0,70
• Počet zubů/inch: 32 (1 inch/palec = 25,4 mm)			
• Plastový držák, prázdný, pro sadu úhlových šroubováků HAZET 2105 Lg/9 H	2105 Lg/9 H L	012022	6,-
• Membrána pro stetoskop HAZET 2151	2151-01	013050	7,-
• Ušní olivky pro stetoskop HAZET 2151	2151-02/2	062287	14,40
• Elektronka · sulfitová žárovka pro 2153	2153-00	013128	2,40
• Odlamovací bříty např. pro univerzální nůž 2157 · 7násobné odlomení 100 x 18 mm sada po 10 ks	2157-04	013210	10,90
• Trapézové bříty s 2 úchyty · např. pro univerzální nůž 2157 sada po 10 ks	2157-05	013227	14,45
• Hákové bříty · např. pro univerzální nůž 2157 · sada po 10 ks	2157-06	013234	17,65
• Trapézové bříty se 3 úchyty · např. pro 2157-1 sada po 10 ks	2157-07	150977	7,75
• Sada náhradních dílů se skládá z: pásu a nýtů pro 2170	2170/2	013388	15,45
• Délka pásu 600 mm			
• Tkaninová páska z bavlny · potažená pryží · výška pásu 19,6 mm			
• Neklouzavé			
• Napínací pás · 396 mm dlouhý · pro 2171-5	2171-05	013395	5,15
• Napínací pás · 496 mm dlouhý · pro 2171-6	2171-06	013401	7,30
• Sada náhradních dílů kolečka ráčny ○ 6,3 = 1/4" obsah sady: kolečko ráčny · fixační prvek · ovládací páka · šrouby · kulička · tlačná pružina Pro přepínací ráčnu HAZET 863 BGL · 863 BKC · 863 BK · 863 MBit · 2264	2264/7	015917	24,75
• Sada náhradních dílů kolečka ráčny ○ 8 = 5/16" obsah sady: kolečko ráčny · fixační prvek · ovládací páka · šrouby · kulička · tlačná pružina Pro přepínací ráčnu HAZET 2264-1 · 6408-1	2264-1/7	015900	26,10
• Náhradní řetěz pro 4682-1	4682-03	149421	116,90
• Náhradní řetěz pro 4682	4682-01	022175	78,75
• Sada náhradních dílů · 9-dílná pro opravu řezného řetězu 4682-01 Pro 4682	4682-01/9	057214	14,95
• Pipeta pro 4810 A · 4810 B	4810 B-05	082650	2,60
• Úchytky pro uchycení řezacího drátu	4852-3	129454	52,20
• Drátový startér k proražení pásu lepidla	4852-5	129478	30,40
• Sada náhradních dílů pro stahovák pružin 4900-1 A a -2 A se skládá ze 2 válcových kolíků a 1 O-kroužku	4900-02 A/3	069415	14,60
• Sada náhradních dílů pro stahovák pružin 4900-1 a 4900-2 se skládá z 5 válcových kolíků a 2 O-kroužků	4900-02/7	063437	33,95
• Plastová vložka pro ochranu lakovaných povrchů pružin. Nehrozí proto nebezpečí poškození pružin vlivem koroze	4900-100	061136	20,50



Jednotlivé díly (E)	HAZET No.	EAN-No. 4000896+	€
Různé jednotlivé díly			
• Plastová vložka pro ochranu lakovaných povrchů pružin. Nehrozí proto nebezpečí poškození pružin vlivem koroze	4900-110	061143	20,50
• Plastová vložka pro ochranu lakovaných povrchů pružin. Nehrozí proto nebezpečí poškození pružin vlivem koroze	4900-120	061150	20,50
• Vysokotlaký manometr použitelný s hydraulickou nožní pumpou 4932-100 • 63 až 1000 barů • Kontrola tlaku při hraničním zatížení vřetene • Měděné těsnění a střížný kroužek pro exaktní nastavení manometru	4932-101	168057	129,60
Pro momentové klíče			
• Průvlečný čtyřhran bez otočného knoflíku 10 = 3/8" ■ Pro 5110 CT · 5110 ST · 5110-1	5110-02	022373	12,65
• Náhradní okénko displeje Pro momentové klíče CLT HAZET 5121-2 CLT · 5122-2 CLT · 5123-2 CLT	5000 CLT-02	117154	8,25
• Průvlečný čtyřhran 12,5 = 1/2" ■ Pro 5121 CT · 5121 ST · 5121-1 5122 CT · 5122 ST · 5122-1 5123 CT · 5123 ST · 5123-1	6414-1	027675	11,20
• Sada náhradních dílů vřetena kompletní dva válcové kolíky Pro momentové klíče HAZET 6391-12 · V · 6391-25 · V · 6391-35 · V · 6391-50 · V	6391-03/3	026968	21,60
• Sada náhradních dílů vřetene komplet dva válcové kolíky pro: 6391-25 · 35 · 50	6391-04/3	026975	21,60
• Sada náhradních dílů vřetene dva válcové kolíky pro 6391-85	6391-05/3	026982	21,60
• Plastová rukojeť Pro momentové klíče HAZET 6391-12 · V	6391-06	026999	8,85
• Plastová rukojeť Pro momentové klíče HAZET 6391-25 · V · 35 · V · 50 · V · 85 · V	6391-07	027002	8,85
• Plastová rukojeť Pro momentové klíče HAZET 6392-200 · V · 320 · V	6392-04	027095	8,85
• Pojistný střížný kolík pro 6800 Alu-700 6800 Alu-1400	6800-01 6800-02	148080 148097	3,55 4,85
• O-kroužek pro zajištění podpěry Pro 6800 ALU-700	6800-03	148288	11,70
• O-kroužek pro zajištění podpěry Pro 6800 ALU-1400 · 6800 ALU-Lg 1400 · 6800 ALU-2800	6800-04	148295	8,80
• Podpěra pro 6800 Alu-700	6800-05	148103	154,60
• O-kroužek pro zajištění střížného kolíku Pro 6800 ALU-2800	6800-08	148936	14,15
• O-kroužek a pojistný střížný kolík pro 6800 Alu-1400 a Lg-1400	6800-010/3	147472	5,95
• O-kroužek a pojistný střížný kolík pro 6800 Alu-2800	6800-011/2	147465	3,85
• Náhradní sada otočného zajištění se skládá z: uzamykací pružiny · otočného zajištění se 2 závitovými kolíky Pro momentové klíče HAZET 6010-1 CT · 6110-1 CT · 6114-1 CT · 6290-1 CT	6110-27	025053	5,90
• Sada náhradních dílů otočného zajištění se skládá z: uzamykací pružiny · otočného zajištění se 2 závitovými kolíky Pro momentové klíče HAZET 5121-2 CLT · 5122-2 CLT · 5123-2 CLT · 5128-2 CLT 6021-1 CT · 6022-1 CT · 6023-1 CT 6111-1 CT · 6115-1 CT · 6121-1 CT · 6122-1 CT · 6123-1 CT · 6127-1 CT · 6128-1 CT 6291-1 CT · 6292-1 CT · 6293-1 CT · 6722 TAC · 6291-2 CT	6122-27	025299	6,40
• Sada náhradních dílů otočného zajištění se skládá z: otočného zajištění · uzamykací pružiny a šroubu s válcovou hlavou Pro momentové klíče HAZET r. v. → 2013 6132-1 CT · 6143-1 CT · 6144-1 CT · 6145-1 CT · 6150-1 CT · 6160-1 CT · 6170-1 CT 6243-1 CT · 6244-1 CT · 6245-1 CT · 6146-1 CT · 6246-1 CT 6294-1 CT · 6295-1 CT · 6296-1 CT	6144-01/3	025527	8,20

Jednotlivé díly (E)	HAZET No.	EAN-No. 4000896+	€
Pro momentové klíče			
• Sada náhradních dílů otočného zajištění se skládá z: otočného zajištění · uzamykací pružiny a šroubu s válcovou hlavou Pro momentové klíče HAZET r. v. 2014 → 6132-1 CT · 6143-1 CT · 6144-1 CT · 6145-1 CT · 6150-1 CT · 6160-1 CT · 6170-1 CT 6243-1 CT · 6244-1 CT · 6245-1 CT · 6146-1 CT · 6246-1 CT 6294-1 CT · 6295-1 CT · 6296-1 CT	6144-02/3	192557	8,05
• Sada náhradních dílů kolečka ráčny 20 = 3/4" ■, obsah sady: kolečko ráčny · fixační prvek · ovládací páka · šrouby · kulička · tlačná pružina Pro přepínací ráčnu HAZET 1016 · 1016/2 Pro momentové klíče HAZET 5145-3 CT · 6132-1 CT · 6143 CT · 6143-1 CT · 6144 CT · 6144-1 CT · 6145 CT · 6145-1 CT · 6146-1 CT	1016/8 N	001989	55,-
• Sada náhradních dílů kolečka ráčny 25 = 1" ■, obsah sady: ovládací páka · šrouby · kulička · tlačná pružina · fixační prvek · kolečko ráčny Pro přepínací ráčnu HAZET 1116 Pro momentové klíče HAZET 6160-1 CT · 6170-1 CT	1116/8 N	003235	65,90
• Sada náhradních dílů kolečka ráčny 10 = 3/8" ■, obsah sady: kolečko ráčny · fixační prvek · ovládací páka · šrouby · kulička · tlačná pružina Pro přepínací ráčnu HAZET 8816 G · 8816 GK · 8816 P · 8816 ST Pro momentové klíče HAZET 5110-2 CT · 5110-3 CT · 5111-3 CT 6110 CT · 6110-1 CT · 6111-1 CT 6114-1 CT · 6115-1 CT · 6402-1	8816 P/7 N	042234	20,85
• Sada náhradních dílů kolečka ráčny 12,5 = 1/2" ■, obsah sady: kolečko ráčny · fixační prvek · ovládací páka · šrouby · kulička · tlačná pružina · pérová podložka · pojistný kroužek Pro momentové klíče HAZET 5121-2 CT · 5122-2 CT · 5123-2 CT 5121-3 CT · 5122-3 CT · 5123-3 CT 5121-2 CLT · 5122-2 CLT · 5123-2 CLT · 5128-2 CT 5122 ST-1 6121 CT · 6122 CT · 6123 CT 6121-1 CT · 6122-1 CT · 6123-1 CT · 6127-1 CT · 6128-1 CT 6722 TAC	6122/9 N	025343	29,45
• Sada náhradních dílů kolečka ráčny 12,5 = 1/2" ■, obsah sady: kolečko ráčny · fixační prvek · ovládací páka · šrouby · kulička · tlačná pružina Pro momentové klíče HAZET 5120-2 CT · 5120-3 CT	5120/7	235490	16,65
• Sada náhradních dílů kolečka ráčny 20 = 3/4" ■, obsah sady: kolečko ráčny · fixační prvek · ovládací páka · šrouby · kulička · tlačná pružina Pro 6150-1 CT · 7250-2 sTAC · 7250-5 sTAC	6150/8	151431	69,45
• Sada náhradních dílů kolečka ráčny 6,3 = 1/4" ■, obsah sady: kolečko ráčny · fixační prvek · ovládací páka · šrouby · kulička · tlačná pružina Pro momentové klíče HAZET 5107-2 CT · 5107-3 CT · 5108-2 CT · 5108-3 CT 6108-1 CT · 6109-1 CT · 6109-2 CT · 6401-1	6401/7	111169	17,90
• Sada náhradních dílů kolečka ráčny 6,3 = 1/4" ■, obsah sady: kolečko ráčny se spouštěcím tlačítkem · fixační prvek · ovládací páka · šrouby · kulička · tlačná pružina Pro 6401-1 S a k přestavení nástrčných přepínacích ráčnů 5107-2 CT · 5107-3 CT · 5108-2 CT · 5108-3 CT 6106-1 CT · 6108-1 CT · 6109-2 CT	6401-1 S/7	111152	25,10
• Sada náhradních dílů kolečka ráčny 12,5 = 1/2" ■, obsah sady: kolečko ráčny · fixační prvek · ovládací páka · šrouby · kulička · tlačná pružina · pružná podložka · pojistný kroužek Pro 6403-1 · 6404-1	6403-1/9	070749	32,40
• Sada náhradních dílů kolečka ráčny 12,5 = 1/2" ■, obsah sady: kolečko ráčny se spouštěcím tlačítkem · fixační prvek · ovládací páka · šrouby · kulička · tlačná pružina · pružná podložka · pojistný kroužek Pro 6403-1 S · 6404-1 S	6403-1 S/9	070817	51,50



Informace

Jednotlivé a náhradní díly



Jednotlivé díly (E)	HAZET No.	EAN-No. 4000896+	€
Pro momentové klíče			
• Sada náhradních dílů ovládací páky obsah sady: ovládací páka · šrouby · kulička · tlačná pružina Pro přepínací ráčnu HAZET 1016 · 1016/2 Pro momentový klíč HAZET 5145-3 CT · 6132-1 CT · 6143 CT · 6143-1 CT · 6144 CT · 6144-1 CT · 6145 CT · 6145-1 CT · 6146-1 CT	1016/6	001972	3,85
• Sada náhradních dílů ovládací páky obsah sady: ovládací páka · šrouby · kulička · tlačná pružina Pro přepínací ráčnu HAZET 1116 Pro momentové klíče HAZET 6150-1 CT · 6160-1 CT · 6170-1 CT · 7250-2 sTAC · 7250-5 sTAC	1116/6	003228	5,-
• Sada náhradních dílů ovládací páky obsah sady: ovládací páka · šrouby · kulička · tlačná pružina · fixační prvek Pro přepínací ráčnu HAZET 8816 G · 8816 GK · 8816 P · 8816 S · 8816 ST · 916 K · 2264-1 Pro momentový klíč HAZET 5110-2 CT · 5120-2 CT · 5110-3 CT · 5111-3 CT · 5120-3 CT · 6110 CT · 6110-1 CT · 6111-1 CT · 6114-1 CT · 6115-1 CT · 6402-1 · 6402-1 S · 6408-1	8816 P/6	144617	8,15
• Sada náhradních dílů ovládací páky obsah sady: ovládací páka · šrouby · kulička · tlačná pružina Pro momentové klíče HAZET 5107-2 CT · 5107-3 CT · 5108-2 CT · 5108-3 CT · 6106-1 CT · 6108-1 CT · 6109-1 CT · 6109-2 CT · 6401-1 · 6401-1 S · 6408	6401-1/6	146048	12,85
• Sada náhradních dílů ovládací páky obsah sady: ovládací páka · 2 šrouby · kulička · tlačná pružina · pružná podložka a pojistný kroužek Pro nástrčnou přepínací ráčnu HAZET 6403-1 · 6403-1 S · 6404-1 · 6404-1 S	6403-1/7	070756	13,55
• Sada náhradních dílů ovládací páky obsah sady: ovládací páka · šrouby · kulička · tlačná pružina · pružná podložka · pojistný kroužek Pro momentové klíče HAZET 5121-2 CLT · 5121-3 CT · 5122-2 CLT · 5122-2 CT · 5122-3 CT · 5122 ST-1 · 5123-2 CLT · 5123-2 CT · 5123-3 CT · 5128-2 CLT · 6121-1 CT · 6121 CT · 6122-1 CT · 6122 CT · 6123-1 CT · 6123 CT · 6127-1 CT · 6128-1 CT · 6722 TAC	6122/7	025329	13,75
• Přepínací ráčna se šroubem kompletní vyměnitelná: ■ 20 = ¾" r. v. → konec roku 2004 Pro momentové klíče HAZET 6132-1 CT · 6143 CT · 6143-1 CT · 6144 CT · 6144-1 CT · 6145 CT · 6145-1 CT · 6146-1 CT	6143-01	111190	167,80
• Přepínací ráčna se šroubem kompletní vyměnitelná: ■ 20 = ¾" r. v. 2005 → Pro momentové klíče HAZET 5145-3 CT · 6132-1 CT · 6144 CT · 6144-1 CT · 6145 CT · 6145-1 CT · 6146-1 CT	6145-01	111206	176,-

Jednotlivé díly (E)	HAZET No.	EAN-No. 4000896+	€
Pro momentové klíče			
• Sada náhradních dílů optického vysílače signálu obsahující: červené tlačítko · přítlačnou pružinu · černou skříňku · kolík · šroub Pro momentové klíče HAZET 6021-1 CT · 6022-1 CT · 6023-1 CT · 6110 CT · 6110-1 CT · 6111-1 CT · 6114-1 CT · 6115-1 CT · 6121 CT · 6121-1 CT · 6122 CT · 6122-1 CT · 6123 CT · 6123-1 CT · 6127-1 CT · 6128-1 CT · 6291-1 CT · 6291-2 CT · 6290-1 CT · 6291 CT · 6292-1 CT · 6293-1 CT	6122-29	025305	8,55
• Úložný box pro bezpečné uložení momentových klíčů Do velikosti BX 8 s průhledovým oknem Pro momentové klíče HAZET 5107-2 CT · 5107-3 CT · 5108-2 CT · 5108-3 CT · 5110-1 CT · 5110-2 CT · 5110-3 CT · 5120-2 CT · 5120-3 CT · 6110-1 CT · 6110-1 CT (CAL) · 6114-1 CT · 6290-1 CT · 6290-1 CT (CAL)	6060 BX-2	024629	30,60
• Úložný box pro momentové klíče HAZET 5121-1 CT · 5121-2 CLT · 5121-3 CT · 6111-1 CT · 6111-1 CT (CAL) · 6115-1 CT · 6121-1 CT · 6121-1 CT (CAL) · 6291-1 CT · 6291-1 CT (CAL) · 6291-2 CT · 6291-2 CT (CAL)	6060 BX-4 6060 BX-6	024636 024643	31,25 34,75
5122-1 CT · 5122-2 CLT · 5122-2 CLT-PD · 5122-2 CT/5 · 5122-3 CT · 6122-1 CT · 6122-1 CT (CAL) · 6127-1 CT · 6292-1 CT · 6292-1 CT (CAL)	6060 BX-8	102907	38,20
5123-1 CT · 5123-2 CLT · 5123-3 CT · 5128-2 CLT · 6123-1 CT · 6123-1 CT (CAL) · 6128-1 CT · 6293-1 CT · 6293-1 CT (CAL)			
Pro pneumatické nářadí			
6děrový náhradní brusný talíř Pro excentrickou brusku 9033-1	9033-010	139378	34,65
• Střední tvrdost • Uchycení suchým zipem • Ø 150 mm s uchycením závitu 5/16"			
• Brusné pásy pro pásovou brusku 9033N-4 330x10 mm. Obsah balení 10 kusů.			
Zrnitost 80	9033-480/10	139101	16,95
Zrnitost 100	9033-4100/10	139118	16,95
Zrnitost 120	9033-4120/10	139125	16,95
• Brusné kotouče pro excentrickou brusku 9033-1 a -2 6 otvorů. Pro zpracování kovů. Ø 150 mm. Obsah balení 10 kusů			
zrnitost 80	9033-180/10	139330	13,60
Zrnitost 100	9033-1100/10	139347	13,-
Zrnitost 120	9033-1120/10	139354	13,-
Zrnitost 150	9033-1150/10	139361	13,-
• Náhradní jehly vhodné pro otloukač rzi 9035-5 19 jehel, Ø 3 mm	9035-050	139385	24,80
• Sada náhradních dílů pro 9036-5 horní a dolní nůž včetně vymezovací podložky a šroubu	9036-05/9	142569	45,35



Skřínky, prázdné

bez plastových vložek, nutno objednat zvlášť

vhodné pro sortiment	Vnější rozměry skřínky mm	HAZET No.	EAN-No. 4000896+	€
Skřínka, prázdná z plastu 854 X	184 x 153 x 52	165 X-S	195688	27,35
Skříň na náradí, prázdná z kovu Pro sadu nástřných klíčů HAZET 888AZN · 888 N · 888 ZN · 1000 · 1000AZ · 1000 Z · 1002 · 1002 Z · 1530 A/38 · 1530 M/49 · 1900/6 · 5292-1 CT/20 · 6292-1 CT/20 · 6292-1 CT/28	578 x 235 x 88	1000 KL	001200	102,30

vhodné pro sortiment	Vnější rozměry skřínky mm	HAZET No.	EAN-No. 4000896+	€
Skřínka, prázdná z kovu Pro sadu nástřných klíčů HAZET 1100 Z	759 x 305 x 115	1100 KL	157419	195,60
Skřínka, prázdná z kovu Pro 986986/9 · 990/9 · 992/9 · 1557/15 · 1557/20 · 1557 N/17 · 1557 N/9 · 2272/17 · 2351/15	225 x 123 x 46	2272 KL	015993	35,05
Kufr, prázdný, s vložkou Pro 4800/9		4800/9 KL	049820	105,20

2komponentní vložky z měkké pěny pro skřínky nahoře

vhodné pro sortiment	HAZET No.	EAN-No. 4000896+	€
163-30/25	163-30 L	118595	73,40
163-31/27	163-31 L	118625	73,40
163-53/75	163-53 L	122509	73,90
163-55/15	163-55 L	122523	71,65
163-57/56	163-57 L	122752	72,40
163-58/27	163-58 L	122769	75,50
163-60/22	163-60 L	122776	64,15
163-95/8	163-95 L	145966	31,60
163-96/3	163-96 L	145973	28,70
163-97/6 · 606 N/6	163-97 L	145980	31,60
163-98/17	163-98 L	145997	60,35
163-99/18	163-99 L	146000	62,40
163-100/13	163-100 L	146017	58,35
163-101/9	163-101 L	146024	58,35
163-102/27	163-102 L	146031	58,35
163-118/57	163-118 L	153480	81,25
163-119/23	163-119 L	153503	62,85
163-120/24	163-120 L	153565	92,15
163-121/4	163-121 L	153558	42,35
163-122/3	163-122 L	153527	36,40
163-124/4	163-124 L	153596	41,20
163-131/8	163-131 L	153619	36,15
163-138/77	163-138 L	151516	89,70
163-139/90	163-139 L	151523	89,70
163-140/33	163-140 L	151837	114,20
163-141/31	163-141 L	151844	95,35
163-143/18	163-143 L	151868	86,55
163-181/17 · 880/17	163-181 L	161492	46,40
163-182/9	163-182 L	161508	50,35
163-184/6	163-184 L	161515	47,75
163-185/5	163-185 L	161522	48,50
163-186/16	163-186 L	162338	67,35
163-191/18 · 932/18	163-191 L	162543	53,80
163-192/24	163-192 L	162550	56,45
163-211/20	163-211 L	164691	70,55
163-215/5 · 986/5	163-215 L	168132	16,90
163-217/6 · 958 N/6	163-217 L	168156	15,90
1557/10	163-218 L	168163	20,25

vhodné pro sortiment	HAZET No.	EAN-No. 4000896+	€
163-220/13 · 986/13	163-220 L	168200	35,60
163-222/13	163-222 L	168194	36,70
163-224/57	163-224 L	176328	47,45
163-226/4	163-226 L	178025	38,85
163-227/3	163-227 L	178131	38,55
163-229/7	163-229 L	178179	37,05
163-230/18	163-230 L	178148	35,50
163-243/7	163-243 L	178315	22,40
163-245/12	163-245 L	178308	22,40
163-251/14	163-251 L	178254	14,20
163-252/9	163-252 L	178247	13,95
163-257/4	163-257 L	179336	34,15
163-259/14	163-259 L	179541	33,75
163-264/5	163-264 L	180646	15,55
163-265/6	163-265 L	180653	15,55
163-269/3	163-269 L	180806	15,25
163-270/9 · 986/9	163-270 L	181049	7,55
163-271/9 · 992/9	163-271 L	181032	9,10
163-292/8	163-292 L	186365	22,45
163-296/7	163-296 L	186693	14,80
163-297/26	163-297 L	186273	33,75
163-299/8	163-299 L	186747	13,80
163-302/6 · 8801/6	163-302 L	186594	11,60
669/10	163-306 L	190997	18,45
4760-M 8x1/9	163-321 L	191963	13,15
4760-M 9x1/9	163-322 L	192021	16,45
4760-M 10x1/9	163-323 L	192076	14,65
4760-M 10x1.25/9	163-324 L	192113	20,90
4760/6	163-325 L	192182	24,85
4797/10	163-326 L	191741	14,95
2272/23 N	163-333 L	192588	7,15
880 N-1	163-334 L	193431	20,85
880 ZN-1	163-335 L	193424	28,50
849	163-336 L	195404	22,55
854	163-337 L	194261	16,30
854-1	163-338 L	194469	17,30
854 T	163-339 L	194452	17,30
4910/13	163-340 L	194445	20,85

vhodné pro sortiment	HAZET No.	EAN-No. 4000896+	€
2200/36	163-341 L	194339	13,45
900 · 900 Z	163-342 L	194438	16,90
1557/29	163-345 L	194407	28,50
1557/32	163-346 L	194896	10,90
844/5	163-347 L	194889	13,45
1557/21	163-348 L	194391	28,50
882-1	163-349 L	194384	22,55
853-1	163-350 L	194872	18,20
882	163-351 L	194377	28,50
880-2	163-353 L	194360	22,55
855-1	163-354 L	194353	22,55
1557/58	163-356 L	194322	17,50
900 AZ	163-357 L	194315	27,10
906	163-358 L	194308	17,25
954 N	163-359 L	194292	18,75
1557/9	163-360 L	194285	13,45
986/9 N	163-361 L	193844	15,60
163-362/39	163-362 L	193929	53,35
163-366/18	163-366 L	197071	53,35
163-367/31	163-367 L	197293	58,70
163-369/104	163-369 L	197309	58,70
163-370/9	163-370 L	197286	58,70
163-371/7	163-371 L	197279	58,70
163-372/25	163-372 L	197262	58,70
163-373/39	163-373 L	197248	58,70
163-374/27	163-374 L	197231	58,70
163-375/5	163-375 L	197347	31,25
163-376/54	163-376 L	197330	30,40
163-377/11	163-377 L	197361	31,25
163-378/11	163-378 L	197316	30,40
163-379/38	163-379 L	197354	31,25
163-380/4	163-380 L	197255	28,10
163-381/9	163-381 L	197323	45,35
163-382/3	163-382 L	197125	36,80
863 MBIT/33	163-384 L	197392	21,-
163-385/12 · 606 N/12	163-385 L	197101	28,50
163-406/20	163-406 L	200009	54,60
163-407/35	163-407 L	200016	39,80



Informace

Obecné bezpečnostní pokyny



- Zvolte ten správný nástroj
- Použijte nástroj podle návodu k obsluze
- Používejte ochranné brýle
- Udržujte nástroj čistý
- Na elektrických zařízeních používejte nástroje s ochrannou izolací



Návod k obsluze si před použitím přečtěte



Označení rozměrů slouží ke správnému přiřazení



Ochranné brýle jsou povinné



Optimální silový záběr zajišťuje dlouhou životnost nástroje a šroubu



Ochrana sluchu je povinná



Dodatečná úprava nářadí je zakázána



Prodloužení ramene páky jen se speciálním nářadím



Ručně ovládané nářadí není vhodné pro rázové šroubováky



Na ruční nářadí nikdy nepoužívejte kladivo



Vždy vytáhněte pouze jednu zásuvku (nebezpečí překlopení)



Zabraňte odrolení v důsledku „nesprávných úderů“



Zásuvky nejsou žádné žebříky



Nepoužívejte šroubovák jako páčidlo nebo dláto



Dílenský vozík nikdy netahejte



Používejte jen šroubovák s vhodnou čepelí a držte jej vždy kolmo



Poškozené a opotřebované nářadí zlikvidujte

Srovnání

německých, amerických, anglických, norských, francouzských a švédských rozměrů pro klíče na šrouby (rozměry s tmavým pozadím jsou rozměry v objednávce)

Metrické rozměry										
Velikost klíče a jmenovitý rozměr mm	Průměr závitu									
	DIN ISO 272				Norské rozměry	Francouzské rozměry	Švédské rozměry SMS			
	Normální šestšhran	Velký šestšhran	Šroub s přírubou	Matice			Metricky	Whitworth	malý 1414	velký 1412
3										
3,2	1,6									
3,5										
4	2			1,7	2,5	2,3				
4,5				2		2,6				
5	2,5			2,3	3	3				
5,5	3			2,6						
6				3	3,5	3,5	3			
7	4	5		3,5	4,4,5	4	3,5			
8	5	6	5	4	5	5	4			
9				5	5,5	5				
10	6	8	6		6	6				
11	7			6	7	7	6			
12					7	8				
13	8	10	8					5/16	1/4	
14				8	8	8				
15		12	10			10		3/8	5/16	
16	10				9					
17				9	10	10	10			
18	12	14	12			12		7/16	3/8	
19				11	11					
20										
20,8	Zapalovací svíčky M 14									
21	14	12	16	14		12	14		1/2	7/16
22					12	14				
23					14					1/2
24	16	14		16		16		5/8		
25										
26	Zapalovací svíčky M 18									
27	18	16	20		16		18	16		
28									3/4	5/8
29					18					
30	20	18		20		20				
32					18	20	22	18	20	
33									7/8	3/4
34	22	20				24				

Americké rozměry						
Velikost klíče a jmenovitý rozměr	Průměr závitu					
	palce	mm	USS		Americká norma	
			Šrouby a matice podle SAE	Šrouby a matice	Šrouby s hlavou	Šrouby a matice
1/8	3,175					
5/32	3,97				0 1	
3/16	4,76				2 3	
13/64	5,16					
7/32	5,56					
15/64	5,95					
1/4	6,35				4	
17/64	6,75					
9/32	7,14					
19/64	7,54					
5/16	7,94	1/8	1/8	5 6		
11/32	8,73				8	
3/8	9,52		3/16	10		
13/32	10,32					
7/16	11,11	1/4	1/4	12 1/4	1/4	
15/32	11,90					
1/2	12,70	5/16	1/4	5/16		5/16
9/16	14,29	3/8	3/8	5/16	3/8	
19/32	15,08		5/16			
5/8	15,88	7/16	7/16	3/8	7/16	
11/16	17,46		3/8			
3/4	19,05	1/2	1/2	7/16	1/2	
25/32	19,84		7/16			
13/16	20,64		9/16	1/2	9/16	
7/8	22,22	9/16	1/2	5/8	9/16	5/8
15/16	23,81	5/8				
31/32	24,61		9/16			
1	25,40	11/16	3/4	5/8	3/4	
1.1/16	26,99	3/4	5/8			
1.1/8	28,57		7/8	3/4	7/8	
1.3/16	30,16					
1.1/4	31,75	7/8	3/4	1		
1.5/16	33,34			7/8	1	

Anglické rozměry					
Jmenovitý rozměr Závít Ø palce	W	BSW velký šestšhran BS.192	BSF a BSW malý šestšhran BS.1083	Velikost klíče	
				palce	mm
				10	.117 2,97
				9	.131 3,33
				8	.152 3,86
				7	.172 4,37
				6	.193 4,90
				5	.220 5,59
				4	.248 6,30
1/16 = 3/32					.256 6,50
				3	.282 7,16
3/32 = 1/8					.297 7,54
				2	.324 8,23
1/8 = 3/16					.340 8,64
				1	.365 9,27
				0	.412 10,49
3/16 = 1/4					.445 11,30
				1/4 = 5/16	.525 13,33
5/16 = 3/8					.600 15,24
3/8 = 7/16					.710 18,03
7/16 = 1/2					.820 20,83
1/2 = 9/16					.920 23,34
9/16 = 5/8					1.010 25,65
5/8 = 11/16					1.100 27,94
11/16 = 3/4					1.200 30,48
3/4 = 7/8					1.300 33,02



Srovnání

německých, amerických, anglických, norských, francouzských a švédských rozměrů pro klíče na šrouby (rozměry s tmavým pozadím jsou rozměry v objednávce)

Metrické rozměry										
Velikost klíče a jmenovitý rozměr mm	Průměr závitu								Francouzské rozměry	
	DIN ISO 272				Švédské rozměry SMS					
	Normální šestřhran	Velký šestřhran	Šroub s přírubou	Matice	Norské rozměry	Metricky	Whitworth	malý 1412		veľký 1413
35						22				
36	24	22			22 24			22 24		
37									1	7/8
38						24				
41	27	24			27			27		
42						27			1.1/8	1
46	30	27			30	30		30		
47									1.1/4	1.1/8
50	33	30			33	33		33		
52									1.3/8	1.1/4
54						36				
55	36	33			36			36		
56									1.1/2	1.3/8
58						39				
60	39	36			39			39	1.5/8	1.1/2
63						42				
65	42	39			42			42	1.3/4	1.5/8
67						45				
70	45				45			45	1.7/8	1.3/4
71						48				
75	48				48			48	2	1.7/8
77						52				
80	52				52			52		2
82						56				
85	56				56			56		2.1/4
88						60				
90	60				60			60		
94						64				
95	64				64			64		2.1/2
100	68				68	68		68		
105	72				72	72		72		2.3/4
110	76				76	76		76		3
115	80				80			80		
116						80				
120	85				84			85		3.1/4
130	90				89			90		3.1/2
135	95				94			95		3.3/4
145	100				99			100		4
150	105				104			105		
155	110				109			110		4.1/4

Americké rozměry						
Velikost klíče a jmenovitý rozměr	Průměr závitu					
	palce	mm	Šrouby a matice podle SAE	USS	Americká norma	
1.3/8	34,92			1.1/8		
1.7/16	36,51	1	7/8			
1.1/2	38,10			1.1/4	1	1.1/8
1.9/16	39,69					
1.5/8	41,28	1.1/8	1	1.3/8		
1.11/16	42,86				1.1/8	1.1/4
1.3/4	44,45					
1.13/16	46,04	1.1/4	1.1/8			
1.7/8	47,63		1.1/4			
2	50,80	1.3/8	1.1/4			
2.1/16	52,39				1.3/8	1.1/4
2.3/16	55,56	1.1/2	1.3/8			
2.1/4	57,15				1.1/2	
2.3/8	60,32		1.1/2			
2.7/16	61,91				1.5/8	
2.9/16	65,09		1.5/8			
2.5/8	66,68				1.3/4	
2.3/4	69,85		1.3/4			
2.13/16	71,44				1.7/8	
2.15/16	74,61		1.7/8			
3	76,20				2	
3.1/8	79,38		2			
3.3/8	85,72				2.1/4	
3.1/2	88,90		2.1/4			
3.3/4	95,25				2.1/2	
3.7/8	98,42		2.1/2			
4.1/8	104,78				2.3/4	
4.1/4	107,95		2.3/4			
4.1/2	114,30				3	
4.5/8	117,48		3			
5	127,00		3.1/4			
5.3/8	136,52		3.1/2			
5.3/4	146,05		3.3/4			
6.1/8	155,57		4			

Anglické rozměry					
Jmenovitý rozměr Závít Ø palce	W BSW velký šestřhran BS.192 BSF a BSW malý šestřhran BS.1083	BS	BA	Velikost klíče	
				palce	mm
13/16	=15/16			1.390	35,31
7/8	=1			1.480	37,59
15/16	=1.1/16			1.580	40,13
1	=1.1/8			1.670	42,42
1.1/8	=1.1/4			1.860	47,24
1.1/4	=1.3/8			2.050	52,07
1.3/8	=1.1/2			2.220	56,39
1.1/2	=1.5/8			2.410	61,21
1.5/8	=1.3/4			2.580	65,53
1.3/4	=2			2.760	70,10
2	=2.1/4			3.150	80,01
2.1/4	=2.1/2			3.550	90,17
2.1/2	=2.3/4			3.890	98,81
2.3/4	=3			4.180	106,17
3	=3.1/4			4.530	115,06
3.1/4	=3.1/2			4.850	123,19
3.1/2	=3.3/4			5.180	131,57
3.3/4	=4			5.550	140,92



A	
Adaptér (spojovací díl)	91, 133–134, 143–144, 156, 163, 167–168, 170–171, 196, 198, 295, 404–407, 440, 456, 470
Adaptér pro sondy	359
Aku nářadí	346–352
Alternátory, nářadí	456
Anglické kladivo	216
Asistent a příslušenství	22–79, 82, 85–103, 111, 113, 115–117, 153–156, 164, 172–173, 183–189, 206, 213, 244–249, 403, 415
Automatické odizolovací kleště	250
Automatické skřípcové kleště	209–210

B	
Babka	458–459
Baterie, nářadí pro servis	227, 452–453
Betonářské kleště	204
Bezpečnostní spojka na vzduch	343
Bity a příslušenství	129–130, 133, 143–144, 156, 192–198, 290, 294–295, 317, 464, 467
BluGuard kladiva	214–216
Brusná, dělicí a obráběcí technika	231–235, 320–334, 418, 461–462

Č	
Čalounění, odjišťovací nářadí	463
Čepový klíč	434

C	
Chladicí systém	187, 210–213, 394–395, 400–407, 469–470
Chráníč blatníků / karoserie	367
Chráníče vozidel	367

D	
Děrovací kleště	460
Diagnostika, zkoušení	187, 239–240, 249, 297–299, 359–360, 403–407, 419–420, 452–457, 466, 469–470
Digitální posuvné měřidlo	239
Dílenský vozík „Asistent“ a příslušenství	22–79, 82, 85–103, 111, 113, 115–117, 153–156, 164, 172–173, 183–189, 206, 213, 244–249, 403, 415
Drátěný kartáč	235, 385, 418
Dřevěné klíny	463
Držák papírové role	51
Držák nářadí	46–51, 130, 147, 344, 368
Držák skel	48
Držáky nástavců a nářadí	293–296
Důlčík	219
Dutá škrabka	232
Dveře – nástroj na (kliky/závěs/obložení)	464
Dvojitá lemovačka	417
Dvojité ploché klíče	85–88, 111–112
Dvojitý očkový klíč	86, 116–118, 392–393, 416

E	
Elektrikářské nářadí	83, 240–253
Elektro / Aku nářadí	352
Elektronický momentový/úhlový klíč	288–289
Elektronický šroubovák	187

E	
Endoskopická technika / inspekční technika	355–373
Excentrická bruska	324

F	
Falcovací kleště	460
Fixační svorník vačkové hřídele	383
Flexibilní drapák / magnetický vyhledávač	360
Flexibilní prodloužení	134, 144
Flexibilní šroubovák / klíč	187
Flexibilní šroubovák / nástrčný klíč	187
Fréza na trubky / odřezávač trubek	234, 417–418
Frézy / Vrtáky	231–235, 320–333, 417–418, 462

G	
Gumové kladivo	217

H	
Hlava válců, nářadí	152, 154, 296–299, 390, 407
Horkovzdušná pistole / horkovzdušný fén	352–353
Hydraulický válec	399

I	
Infračervený teploměr	360
Inspekční technika / endoskopická technika	355–366, 419–420, 452–457
Izolační podložka	251

J	
Jednostranný klíč	102, 112, 245, 295
Jednostranný uzavřený klíč	245, 296, 394, 468
Jednotlivé a náhradní díly	103, 131, 137, 140, 144, 148, 151, 160, 163, 165, 168–169, 171, 195, 198, 216–218, 227, 287, 294, 418, 464

K	
Kardanový (univerzální) kloub	133, 137, 139, 144, 147, 149, 156, 163, 167–168, 170–171, 409, 413, 416
Karosářské nářadí	84, 204, 209–210, 219, 231, 324–327, 332–335, 458–467, 481
Kartáče / pilníky	231–232, 235, 238, 385, 418–419, 421, 444, 453, 459, 461
Kladiva	214–220, 462–463
Kladiva s elastickou hmotou	462–463
Kladivo bez zpětného rázu	216
Kleště	99, 199–213, 233, 249–251, 385–389, 391–392, 394, 400–403, 423, 447–448, 450–451, 460–461, 463, 465
Kleště na hadicové spony Clic	210, 400
hadicové svorky / hadicové spony	210–213, 400–403
kroucení drátu	205
pojistné kroužky / ploché kleště	205–208, 403, 423, 447–448
spony manžet	208, 447–448
trubky	204–205, 250
vyvažovací závaží kol	450
Kleště pro benzinové vedení	394
Kleště, ploché (kulaté)	203, 250, 465
Klíč na filtr Ad-Blue	469



K

Klíč na kartuše	471–472
Klíč na matice se dvěma otvory	382
Klíč na šroubení trubek	118, 139, 151, 296
Kloub	133, 137, 139, 144, 147, 149, 156, 163, 167–168, 170–171, 409, 413, 416
Kluzné kladivo	230, 468
Kobercový nůž	233–234
Kombinované kleště	199–213, 249
Konektorové kleště	251
Křížový klíč	450, 479
Křížový klíč / matice na kola	157–161, 167, 171, 449–451, 479–480
Křížový sekáč	218
Kruhový pilník	231
Kruhový úhelník, mechanický	296
Kufr	80
Kulaté kleště	250
Kulová hlava – prodloužení	134, 144, 156
Kyselinoměr	407

L

Lambda sondy, nářadí	409
Lampa, flexibilní	362
Lampy / Svítily	361–366
Lemovačka	417–418
Leštící nářadí	326, 329
Listová měřka	240

M

Magnetická miska	368
Magnetický držák	343–344
Magnetický hledač / magnetický zvedák	360
Magnetický nástavec pro nástrčné klíče	132, 138, 150
Mazací lis	339, 342, 369, 371
Měděné kladivo	217
Měřicí pásmo	239–240
Měřicí technika	239–240
Mikrometr	239
Momentové / Úhlové klíče	288–289
Momentové nářadí a příslušenství	165, 169, 252, 255–299
Momentový / úhlový klíč sTAC	288–289
Montážní klín	463
Montážní páka	220, 419, 450–451, 463
Montážní páka na pneumatiky Runflat	451
Montážní vozíky	33–43, 56–61, 64–75
Multi Table	43
Multibuska	325

N

Nápravy	208, 220, 360, 434–440, 443–449, 465, 474–480
Nářadí - injektor	395–399
Nářadí Impact	134, 144, 157–163, 167–168, 170–171, 198, 301–344, 346–353, 448–449, 467–481
Nářadí na brzdy	118, 166, 207, 219, 232, 234–235, 415–423, 443–444, 471–473
náboje /ložiska kol	435–440, 443–446, 449, 474–480
pružící jednotky / stahovák pružin	424–433
výfuky	234, 408–409
Nářadí pro demontáž rádia	457
drážkové (žebrové) řemenice	381–382, 456–457
nastavení motoru	382–384

N

Nářadí pro servis olejů	368, 410–415, 467, 469–471
silentbloky	445–446
tváření plechu	84, 204, 209–210, 219, 231, 324–327, 332–335, 458–467
užitková vozidla	166, 168, 410–411, 435, 467–481
Nářadí s ochrannou izolací	247–252
Nářadí spony Henn	403
Nástavce (bity) a příslušenství	129–130, 133, 136, 143–144, 146, 156, 165, 169–170, 193–198, 290, 293–295, 317, 387–389, 409, 413, 433, 436, 464–465, 467
Nastavitelný klíč	112
Nástrčná hlavice pro rázový a strojový utahovák a příslušenství	134, 144, 157–163, 167–168, 170–171, 198, 301–344, 346–353, 448–449, 467–481
Nástrčná hlavice s kulovou hlavou	133, 143, 153, 393, 413
Nástrčné hlavice (ořechy)	131–134, 138–144, 149–155, 157–163, 165–168, 170–171, 198, 246–247, 384, 386–390, 392–393, 395, 409–411, 413–415, 433, 436, 446–449, 465, 467–481
Nástrčné hlavice a bity	129–131, 133–134, 137–138, 143–144, 149, 156, 165, 169–170, 193–198, 247, 290, 294–295, 387–388, 409, 413, 433, 464–465, 467–468
Nástrčný klíč s kloubem	139, 141, 168, 171, 388–389, 409, 413, 416
Nástroj pro nastavení světlometů	465
Naviják hadice	341, 345
Nůž	233–234, 251
Nůž, skládací	233–234, 251
Nůžky	233, 249, 460
Nýtovací nářadí	334–335, 461
Nýty, nářadí pro slepé nýty	334–335, 461

O

O-kroužek, pojistná pružina a spojovací kolík	144, 163, 168, 171
Ochrana při práci	367, 373
Ochrana přístrojů	466
Ochrana proti skřípnutí	440
Očkoploché klíče	85, 112–115
Očkoplochý klíč	85, 112–115
Očkový klíč	85, 112–115, 296, 392–399, 468
Očkový rázový klíč	472, 479
Odizolování kabelů	250–251
Odizolovací nářadí	250–251
Odklon, nastavovací nářadí	436
Odměrka	369
Odsávací/ofukovací pistole	339
Ofukovací pistole / tužka	335–337
Ohebná lampa	362
Ohebné prodloužení	134, 144
Opravy závitů	236–238, 389, 395
Optický refraktometr	407
Ořechy	131–133, 138–144, 149–155, 157–163, 165–168, 170–171, 198, 246–247, 384, 386–390, 392–393, 395, 409–411, 413–416, 436, 446–449, 465, 467–481
Organizér nářadí	81, 85–103, 111, 113, 115–116, 119–163, 172–173, 183–186, 188–189, 193, 206, 213, 237–238, 245–249, 384, 395–399, 403, 415–423, 433
Otevřené stranové klíče	85–103, 105–253, 295



O

Otevřený (dvojitý) očkový klíč	118, 139, 151, 296, 392–399
Otočná tyč	165, 169–170
Otočné prodloužení	134, 144, 156
Otočný kloub	342
Ozubené řemeny, nářadí	381–384, 456–457

P

Páčidla	220
Pákové stranové štípací kleště	203
Palice	216–217
Palice BluGuard	216
Palivový systém, nářadí	133, 196, 210, 381, 393–400, 467–469
Paralelní svěrák	372
Pásová bruska	324
Pásový klíč	391, 412
Pentagramový klíč	139, 151
Pila	233
Pila na kov	233, 332
Pilníky / Kartáče	231–232, 235, 238, 385, 418–419, 421, 444, 453, 459, 461
Pístní kroužky	391
Plastové / šetrné kladivo	216–217
Plnicí / přečerpávací čerpadlo	370
Plnicí trychtýř	369, 414–415
Plnicí trychtýř motorového oleje	414–415
Plochý klíč (očkový/rázový)	479
Plochý klíč, malý	85, 112
Plochý sekáč	218–219, 460
Pneumatické nářadí a příslušenství	301–344, 346–353, 437–438
Pneumatický mini nástroj	317, 323, 329–331
Pneumatiky, nářadí	338, 419, 435, 438, 450–451, 479–480
Podložka pod kolena	367
Podložka pro mechaniku	367
Podpěra motoru	375–481
Pojistná pružina, O-kroužek a spojovací kolík	144, 163, 168, 171
Pojízdný pracovní stůl	44–47, 76–79
Posuvná měrka	239, 420
Posuvná rukojeť / příčná rukojeť	131, 138, 149, 165, 169, 188–189, 413, 465
Potah sedadla a volantu	367
Pracovní stůl	44–47, 78–79
Pracovní svítlna	361–366
Přečerpávací / plnicí čerpadlo	370
Přepínací ráčna	115–116, 130–131, 136–137, 147–148, 165, 169, 195, 198, 255–299, 301–344, 346–353
Přestavitelný klíč	112
Příčná / posuvná rukojeť	131, 138, 149, 165, 169, 188–189, 465
Přimazávač / Olejnička	343–344, 369
Přímočará pila	332
Přípravek k seřízení ostřikovačů okenního skla	466
Prodloužení	133–134, 144, 156–157, 163, 167–168, 170–171, 247
Prostřihovač	334
Protiskluzová podložka	48
Proudová / napěťová zkušební	187, 249, 452–457
Průbojník	219–220
Průvlečný / zástrčný čtyřhran	294–295

R

Rabicové/monýrovací kleště	204
Ráčna s klíči v boxu	80, 86, 88–95, 101–102, 119–173, 188, 193, 245, 415–423

R

Ráčna/ráčny/řehtačka	115–116, 130–131, 136–137, 147–148, 165, 169, 195–196, 198, 252, 255–299, 301–344, 346–353, 433
Ráčnový šroubovák	301–344, 346–353
Rázové hlavice a příslušenství	134, 144, 157–163, 167–168, 170–171, 198, 318–319, 348–351, 448–449, 467–481
Rázový stahovák / rázový vytahovák	230, 468
Rázový utahovák	198, 301–344, 346–353
Redukční tlakový ventil	344
Refraktometr	407

Ř

Řehtačka/ráčna	115–116, 130–131, 136–137, 147–148, 165, 169, 195–196, 198, 252, 255–299, 301–344, 346–353, 433
Řemenice, nářadí	381–382, 456–457
Řetězový řezák trubek	234, 408
Řezačka trubek, malá	234

R

RIBE-CV nářadí	95, 154–155, 390
Rohové trubkové kleště	205
Rozbrušovací pila	327
Ruční pumpa	370
Ruční svítlna	362
Rukavice	373
Rychloupínací stahovák	221–227
Rýsovací jehla	231

S

Sací a tlaková plnička	370
Sada nářadí / Sortiment	46–47, 52–103, 111–113, 115–117, 119–173, 183–191, 193, 195, 197–198, 206, 208, 213, 219–220, 225–230, 236–237, 240–253, 286–287, 294, 324–326, 360, 383, 389, 394–399, 403, 412, 415–424, 427, 431, 433–434, 436, 439–440, 443, 445–446, 448–449, 452–467, 471–475, 477–478, 480–481
Sada nástrčných klíčů	80, 86, 88–95, 101–102, 119–173, 188, 193, 245, 415–423
Sada vsuvek pro připojení hadice / vzduchu	342
Sekáč, průbojník, důlčik	218–220
Sekera	217–218
Seřizovací a zkušební přístroje pro momentové klíče	297–299
Servisní vozík Assistent®	33–43, 56–61, 64–75
Siko kleště	204–205, 250
Silová páka	220
Silové kombinované kleště / stranové štípačky	202, 249
Škrabák, plochý	232
Škrabka	232–233
Skříň / kufr / schránka na nářadí	46–47, 80–81, 89–90, 95, 101–102, 119–173, 193, 245, 415–423
Skřípcové kleště	209–210
Smartcase	81, 85–103, 111, 113, 115–116, 119–163, 172–173, 185–186, 188–189, 193, 213, 237–238, 245–249, 389, 396–399, 403, 415–423, 433
Sodová tryskáč pistol	340
Sortiment	46–47, 52–84, 237, 240–253, 453–455, 458–467, 480–481



S

Špičatě kleště	203, 250
Spirálová hadice	340
Spirálový vrták	231–235, 462
Spojky, nářadí na opravy	409
Spojovací díl (adaptér)	91, 133–134, 143–144, 156–157, 163, 167–168, 170–171, 196, 198, 295, 404–407, 440, 456, 470
Spojovací kolík, pojistná pružina a O-kroužek	144, 163, 168, 171
Šroubovací nářadí TORX®	80, 86, 89–98, 118–133, 135, 140–141, 143–145, 151, 154–155, 161, 163, 166, 168, 172–173, 182–183, 185–189, 191, 193–194, 197, 246, 248, 384, 390, 408–409, 433–434, 456, 464, 467–481
Šroubovací nářadí XZN	89–90, 93, 95, 143, 154–155, 162, 194, 197, 246, 390, 413, 449, 456, 464
Šroubovák	86, 95–99, 155, 174–198, 247–249, 290, 464–465
HEXAnamic	174–198
pro šrouby s vnitřním šestihranem (nástavce)	89–90, 95, 101–102, 129, 132–133, 142–143, 151–153, 155, 166, 188–191, 193–194, 197, 245–247, 390, 393, 395, 413, 415–423, 433, 446–449, 465
s pěticípou hvězdou	194–195
trinamic / TRInamicULTRA	183, 185–186
Stahovací nářadí	204, 221–230, 381, 385–386, 395, 408, 424–451, 456–457, 463, 467–469, 473–479
krokví	230
modulu zapalování / cívek	469
pružin, vnitřní	431
sloupku řízení	226, 467–469
trámů	230
větráku	226
Stahováky kulových kloubů	230, 434–444, 473–479
Stahováky, vyťahováky, vytlačovací šrouby	229–230, 434–446, 468, 473–479
Štípací nářadí	217–218
Stopková bruska	321–323, 331
Stranové štípačky	202–203, 249
Stříkací pistole / přístroj / postřiková láhev	339–340, 369–372
Svěrák	372
Světelná a proudová zkušební pro auta	452–453
Svinovací metr	239–240
Svírací kleště	394
Svorkovnice / držák svorkovnice	48, 130, 147
Systém vložek / pořadačů do zásuvek	48–51, 81, 85–103, 111, 113, 115–116, 153, 155–156, 163, 173, 183–186, 188–189, 206, 213, 245–249, 403, 415–423

T

T-rukojeť pro šroubování	131, 138, 149, 188–189, 413, 464–465
Teleskopická přepínací ráčna	148
Teleskopická řezačka trubek	234
Teleskopické zrcátko	360
Tester nemrznoucích kapalin	407
Tester ztráty tlaku	407
Tisícíhnan, šroubovací nářadí (XZN)	89–90, 93, 95, 143, 154–155, 162, 194, 197, 246, 390, 413, 449, 456, 464
Tlakový postřikovač	371–372
Tlumiče pérování	424–451
Trhač matic	238

T

Trhák s kloubem	137, 149
Trychtýř	369, 414–415
Twin Turbo Rázový utahovák	313–315

Ú

Úhlová bruska	323, 329–331, 352
Úhlová škrabka	233
Úhlová vrtačka	320–321
Úhlový šroubovák	190–191
Úložný vkládací systém (Safety Insert System)	81, 85–103, 113, 115–116, 142, 146, 153, 155–157, 163, 173, 183–186, 188–189, 206, 213, 237–238, 245–249, 384, 389, 395–399, 403, 415–423, 433

U

Univerzální kleště	204–205, 250
Univerzální kloub	133, 137, 139, 144, 147, 149, 156, 163, 167–168, 170–171, 409, 413, 416
Univerzální nůž / nůžky	233–234
Univerzální pásový klíč	412
Univerzální stahovák	225, 227
Univerzální stahovák pružin	424–451
Upínací desky (stahováku pružin)	425–427
Upínací popruh / uzavazovací popruh	372

V

Vakuový manipulátor	48
Ventily – (nastavovací) nářadí	391–392
Víceúčelová vana	368
Videoendoskop	355–373
Vidlicový klíč	85–103, 105–253, 295
Vlasová měřka	240
Vložka z měkké pěny	85–103, 111, 113, 115, 119–163, 172–173, 183–184, 193, 206, 238, 245, 384, 389, 395, 415–423
Vrtačka	351
Vrtáky / Frézy	231–235, 320–333, 417–418, 462
Vstříkovací systémy	133, 196, 210, 381, 392–400, 468–469
Výfukové systémy	234, 408–409
Vyklepávací / karosářské nářadí	84, 204, 209–210, 219, 231, 324–327, 332–335, 458–467, 481
Vypichovák KABELOVÝCH SYSTÉMŮ	453–455, 480–481
Vyrážeč výstupkových klínů	474
Vysklívací nářadí	466
Výsuvná přepínací ráčna	148
Vyťahovací drapák	360
Vyťahovák čepů	236–237
Vyťahovák podpěrných čepů	229, 236–237
Vyťahovák šroubů	236–238
Vyťahovák, vnitřní	229–230, 468
Výtažný klíč na matice kol	450–451
Vytloukač závlaček	219–220

Z

Zámečnické kladivo	214–220
Zapalovací svíčky	137, 140, 150–151, 204, 235, 240, 385–389
Zástrčná rukojeť	131, 138
Žhavicí svíčky	388–389, 395
Zkoušečka napětí	187, 249
Zkoušečka utahovacího momentu	297–299
Zkoušení, diagnostika	187, 239–240, 249, 297–299, 359–360, 403–407, 419–420, 452–457, 466, 469–470



Informace

Číselný seznam



HAZET No.	Strana	HAZET No.	Strana	HAZET No.	Strana	HAZET No.	Strana	HAZET No.	Strana	HAZET No.	Strana
1850 VDE	249	2140.	216	2520.	463	4658.	251	4971.	423, 472-473	8820.	144
1851.	202	2141.	216	2527-5.	413	4670	453-454, 480-481	4972	473	8821.	144
1851 M.	202	2142.	216	2527-8.	393					8821 KV.	247
1860 VDE	250	2143.	217	2528.	413	4671.	454	5000 CLT.	280	8822.	144
1862.	250	2144.	217	2530.	388	4672.	454-455	5000 KV.	252	8830.	144
1863.	250	2145.	240	2534.	220	4673.	455	5000-3 CT.	278	8858.	143
		2147.	240	2534-1.	465	4674.	455	5200-3 CT.	279		
1905.	458	2150.	231	2540.	381	4680.	409			9000.	343
1911.	458	2151.	360	2561.	392-393	4682.	234, 408	6000 CT.	290	9000-010-014	342
1917 N.	458	2152.	452	2567.	413	4684.	408	6000-1 CT.	280-282	9000-020-022	342
1918 N.	458	2152 N	452	2579.	390	4685-1.	474	6000-1 CT-US	283	9000-040	342
1919 N.	459	2153.	452	2582.	419	4685-2.	474	6001	290	9000-041	342
1920 N.	459	2154.	239	2583.	436					9000-050-080	343
1921.	459	2154 N.	239	2584.	446	4760.	389	6100	287	9005 S.	163
1922.	459	2155.	240	2584-1.	395	4760	389			9006 S.	163
1923.	459	2155 N.	239	2584-8.	415	4766.	387-388	6200-1 CT.	284-285	9007 S.	163
1927.	459	2156.	251	2587.	382	4767 AKF.	388	6290	286	9011 M.	311
1928 K.	459	2156 VDE	251	2588.	383	4793	407	6292	286	9012.	311-313
1929-1.	459	2157.	233-234	2588	382-384	4795.	407			9012 ATT.	312
1930.	459	2158.	233	2592.	456	4797.	469	6300.	291-292	9012 EL SPCS	343
1930-1.	459	2160.	369	2593.	434	4797	395	6396.	293	9012 TT	313
1931.	459	2162.	342, 369-371	2597.	464	4798.	396-399	6399.	292	9013.	314
1932.	460	2163.	370	2597-Z.	464	4798	396, 398-399			9013 TT	314-315
1934.	461	2164	220	2598.	464			6400	286	9014 P.	315-316
1934 N.	461	2165.	220			4800.	404-407, 470	6401.	293	9014 TT	315
1935-1938 K	462	2166.	220	2710.	434	4800	404, 469	6401 S.	293	9020.	316
1940-1943	462	2168.	467, 469	2730.	419	4800	403	6401-1.	293	9021.	317
1944-1950	462	2168-2.	392	2756.	409	4801.	403	6408.	294	9022.	318-320
1951.	217	2169.	410-412, 470-471	2760.	413	4801	403	6413.	294	9023 M.	317
1952.	217			2780.	434	4802.	470	6414.	295	9030.	320-321
1952	217	2169	412	2784.	166, 415, 471	4810 C.	407	6420.	295	9032.	321-323
1953.	216	2170.	412	2784 S.	481	4812.	359-360	6423.	295	9032-Z.	331
1953-Z.	216	2171.	412, 471	2784 S Lg	481	4812 N	359	6430.	295	9033.	324-331
1959.	462-463	2172.	412-413	2784 SR.	481	4812	359	6450 C.	295	9034 P.	332
1960.	460	2174.	409	2784	471	4850.	466			9035.	332-333
1961.	460	2175 N.	372	2788.	384	4852	466	6602.	293	9035 H	333
1963.	461	2180.	234	2797.	465			6606 D.	296	9035 V	333
1964.	460	2181.	234	2797-2.	465	4900.	424-427	6612 C.	296	9036.	334
1965.	463	2183.	205			4900	424, 427	6630 C.	296	9037.	334-335
1965	463	2191.	417	2849.	468	4902	431	6690.	296	9040.	335-337, 340-341
1967.	231, 462	2191	417	2850.	168, 467	4903.	432			9040 D.	345
1975.	360	2193.	418	2871.	472	4910.	433	7000 sTAC.	288-289	9040 Lg	337
1976.	360	2193	418	2871-E 12	468	4910	433			9041.	338
1977.	360	2193	418	2872.	472	4912.	436	7900 E.	297-298	9042.	339
1979.	361-366	2195.	471	2872 FS.	472	4912	436	7920 E.	298-299	9042 N.	339
1980 N.	233			2872 SZ.	472	4915	434			9043.	339
1981.	233	2200	129, 193			4925	445-446	8501.	132	9043.	339
1987.	373	2204.	194	2901 G.	416	4929	446	8501 KK.	133	9045.	340
1987-5.	373	2206.	197	2991.	392	4930.	436-438	8502.	133	9070.	343-344
1988.	372	2208.	194			4930	436	8503.	133		
1990	352-353	2210.	197	3047.	448	4931	438	8506.	133	9212 M.	348-349
1991.	360	2211.	194	3087.	382	4932.	437-438	8507.	133	9212 SPC	348
		2212.	197			4934.	438, 440	8508 S.	134	9212-1000	350
2025 X.	48	2215.	194	3420.	414	4934	439-440			9212	349
2025 X	48	2216.	194	3488	384	4935	443, 449	8801.	142	9213-1000	350-351
		2217.	197			4937.	475-479	8801 A.	142		
2100.	190	2218.	197	3702.	414	4937	474-475, 477-478, 480	8801 K.	142	9230	351
2100	190	2223.	194	3703.	414			8801 K-KV.	246	9233	352
2105 Lg	190	2223 Lg	194, 467			4954.	419	8801 KK.	143		
2105 Lg	191	2224.	197	4501.	394	4956.	420	8801	142	9400.	344
2115.	191	2224 S Lg	197	4550.	393, 468	4960 F	443	8802.	143		
2115	191	2225.	194-195	4555.	393	4960 R	444	8802 KV.	246		
2116 Lg	191	2238.	196	4556.	393	4960 V	444	8802 KV-Lg	246		
2119.	231	2239.	196	4558.	468	4960	443	8803.	143		
2120.	231	2240 N	193	4560.	393	4961 N	444	8806.	143		
2122.	232	2250.	133, 143, 156, 196, 198	4561.	394	4963.	416	8807 S.	144		
2123.	231			4562.	403	4964.	416	8808.	143		
2126.	238	2255.	196	4590.	394	4968.	232, 235, 416, 418-419, 421, 423	8808 Lg	143		
2128.	231	2264.	198	4590	394			8808 Lg KV	246		
2130.	235	2265.	196	4591.	395	4968	416, 420-421	8808 S.	144, 198		
2131.	235, 385	2272.	198	4618.	414			8812 U.	138		
2132.	217	2272	197	4641	456	4969.	472	8814.	137		
2133.	217			4650.	452-453	4969	421	8815.	138		
2134.	218	2304.	196	4655.	457	4970.	422-423	8816.	136-137		
2135.	218			4656.	251	4970.	421-422	8816	137, 198, 294		
2139.	216	2505.	387								



A. Obecná ustanovení

I. Platnost

- Podkladem pro všechny nabídky, prodeje, dodávky a služby společnosti HAZET-WERK Hermann Zerver GmbH & Co. KG (dále jen: „HAZET“) jsou výhradně níže uvedené všeobecné obchodní podmínky (dále jen „obchodní podmínky“). Obchodní podmínky kupujícího, které jsou v rozporu, ve smyslu § 305 násl. občanského zákoníku („BGB“), především nákupní podmínky kupujícího v žádném případě neplatí, ani tehdy ne, kdyby je společnost HAZET po přijetí znovu nerozporovala.
- HAZE uvedené obchodní podmínky jsou součástí všech smluv, které společnost HAZET uzavře se svými smluvními partnery o dodávkách a službách. Jsou uznány udělením zakázky nebo přijetím dodávky. Neplatí ve vztahu ke spotřebitelům ve smyslu ust. § 13 občanského zákoníku.
- Změny a/nebo doplnění těchto podmínek platí jen při realizaci příslušné písemné dohody. Písemná forma ve smyslu těchto obchodních podmínek zahrnuje také textovou formu
- Označení „kupující“ představuje smluvního partnera nezávisle na povaze smlouvy.
- Není-li v těchto podmínkách uvedeno jinak, jsou dále pro výklad různých prodejních ustanovení určující přepravní podmínky INCOTERMS® 2020.

II. Nabídky a uzavření smlouvy

- Nabídky společnosti HAZET jsou otevřené a nezávazné. Objednávky může společnost HAZET přijímat do 30 dnů. Kupující je tedy minimálně po tuto dobu svou objednávkou vázán. Objednávka je uznána jako přijatá, jakmile ji společnost HAZET zákazníkovi písemně potvrdí. Dodávka a faktura platí současně jako potvrzení zakázky.
- U podkladů patřících k nabídce (obrázky, výkresy, popisy apod.) si společnost HAZET vyhraduje vlastnictví a autorské právo. Tyto podklady smí být zpřístupněny třetím osobám jen v případě, že jsou určeny k dalšímu předání. V opačném případě musejí být společnosti HAZET na požádání vráceny zpět.
- Údaje, výkresy, obrázky, technické údaje, údaje o hmotnosti, rozměrech a popisy výkonů uvedené v prospektu, katalozích, oběžnících, oznámeních, cenících nebo podkladech patřících k nabídce mají poskytnout jen všeobecnou představu o popisovaném zboží. Neobsahují žádná prohlášení, jiná zajištění nebo záruky a nejsou součástí smlouvy. Odchytky nebo změny obvyklé v obchodním styku, které vyplývají na základě právních předpisů nebo představují technická vylepšení, jsou přípustné, pokud nenarušují použitelnost ke smluvně zamýšlenému účelu.

III. Ceny

- Ceny se rozumí netto bez slevy s připočtením DPH v aktuálně platné zákonné výši, pro přepravu ze závodu nebo ze skladu a nezahrnují balné, poštovné a zajištění hodnoty.
- Pokud hodnota zásilky kupujícího překročí 750,- Euro netto, tzn. bez DPH, bude dodávka provedena zdarma na adresu kupujícího na území Německa, bez fakturace běžného balného. Platí výhradně pro dodávky na adresu kupujícího. Při odlišné dodací adrese platí ceny uvedené pod bodem III. 1.

IV. Platební podmínky

- Není-li písemně sjednáno jinak nebo to není uvedeno na faktuře, jsou faktury splatné okamžitě a bez srážky v eurech, a to bez ohledu na prodloužení v dodávce zaviněné společností HAZET. Dohodnuté skonto se vztahuje vždy pouze na fakturovanou hodnotu kromě přepravného. Pokud není dohodnuto jinak, začínají lhůty skonta od data faktury.
- Rozhodující pro včasnost platby je připsání na účet společnosti HAZET.
- Nejsou-li dosud uhrazeny pohledávky kupní ceny na základě starších splatných faktur, je v každém případě nepřipustné odečtení skonta.
- Šeky a směnky rediskontní u spolkové banky přijímá společnost HAZET pouze na základě zvláštních dohod a pro účely provedení plateb.
- Směnky nebo šeky budou s výhradou doručení připsány na účet k datu valuty a platí jako platba teprve v den, kdy společnost HAZET může definitivně disponovat protihodnotou. Veškeré z toho vyplývající náklady a výdaje hradí kupující.
- Pokud je kupující v prodlení s placením, musí kupující případnou pohledávku úročit 9 procentními body nad základní úrokovou sazbu ve smyslu § 247 občanského zákoníku. Právo na uplatnění náhrady další škody z prodlení zůstává tímto vyhrazeno.
- Pokud je po uzavření smlouvy rozeznatelné, že nárok na platbu společnosti HAZET bude ohrožen nedostatečnou platební schopností kupujícího nebo nastanou jiné okolnosti, ze kterých lze vyvodit značné zhoršení jeho platební schopnosti, může společnost HAZET odmítnout dohodnuté předběžné plnění a rovněž uplatnit práva z § 321 občanského zákoníku. To platí také tehdy, pokud ještě nenastala povinnost HAZET poskytnout plnění. Společnost HAZET může v takových případech učinit splatné všechny pohledávky z probíhajícího obchodního vztahu s kupujícím. Jako nedostačitelná platební schopnost kupujícího platí také, když je kupující v prodlení s platbou se značnou částkou minimálně tři týdny, dále k tomu patří značné snížení jeho limitu u zajišťování kreditu zboží HAZET.
- Zadržování plateb nebo zúčtování s protinároky kupujícího je přípustné jen tehdy, jestliže jsou protinároky nesporné a právoplatně stanovené, nebo by kupujícího opravňovaly k odmítnutí jeho platby podle § 320 občanského zákoníku.
- Od nároků společnosti HAZET lze odstoupit pouze s písemným souhlasem společnosti HAZET.

V. Zajištění / výhrada vlastnictví

- Vlastnictví na dodaném zboží („zboží s výhradou“ v tomto oddílu A. V.) bude přeneseno pod odkládající podmínkou úplného zaplacení kupní ceny. Kromě toho si společnost HAZET vyhraduje vlastnictví na veškerém dodaném zboží až do splnění veškerých pohledávek HAZET, obzvláště také příslušných sald pohledávek, které společnosti HAZET náleží v rámci obchodního spojení (výhrada salda). To platí i tehdy, jsou-li platby zvlášť specifikovaných pohledávek uhrazeny. Výhrada salda zaniká s konečnou platností s vyrovnáním všech pohledávek ještě otevřených v době platby a zahrnutých v této výhradě salda. Při platbách předem nebo platbách v hotovosti ve smyslu § 142 insolvenčního zákona platí výhradně jednoduchá výhrada vlastnictví podle A. V. 1. věta 1, rozšiřující a prodlužující formy potom neplatí.

- Kupující smí prodat zboží s výhradou vlastnictví jen v běžném obchodním styku a v případě, že není vůči společnosti HAZET v prodlení s úhradou nezaplacených pohledávek. Veškeré z toho vyplývající pohledávky vůči třetím osobám postupuje tímto kupující předem společností HAZET, a to ve výši příslušné fakturované hodnoty dále prodaného zboží s výhradou vlastnictví včetně zákonné stanovené DPH. HAZET toto postoupení akceptuje. To samé platí pro ostatní pohledávky, které se dostanou na místo zboží s výhradou nebo vzniknou jinak ohledně zboží s výhradou, jako např. pojišťovací nároky nároky z nepovoleného jednání při ztrátě nebo poničení.
- Pokud kupující prodá zboží s výhradou vlastnictví společně s jinými věcmi, které nedodala společnost HAZET, pak platí postoupení pohledávky z dalšího prodeje jen ve výši fakturovaných hodnot uvedených na fakturách společnosti HAZET příslušného prodaného zboží s výhradou vlastnictví. Při zpracování, spojení a smíchání kupujícím zboží s výhradou s ostatním zbožím náleží HAZET spoluvlastnictví na něm v poměru fakturované hodnoty zboží s výhradou k fakturované hodnotě jiného použitého zboží. Pokud spojením nebo smícháním zanikne vlastnictví HAZET, tak přeneše kupující HAZET již nyní jemu náležející vlastnická práva na nový stav nebo věc v rozsahu fakturované hodnoty zboží s výhradou a bezplatně je uschová pro společnost HAZET. Spoluvlastnická práva platí jako zboží s výhradou.
- Kupující je oprávněn inkasovat pohledávky z dalšího prodeje třetím osobám.
- Společnost HAZET je v případě prodlení kupujícího s platbou a rovněž v případě podstatného zhoršení majetkových poměrů dle A. IV.7. oprávněna odvolat oprávnění k inkasu, udělené v bodě A. V. č. 4. Také bez takového odvolání, zaniká oprávnění k inkasu s podáním vlastního návrhu na zahájení insolvenčního řízení nebo s nařízením zabezpečujících opatření v insolvenčním řízení. Na požádání je kupující povinen společností HAZET oznámit postoupené pohledávky a jeho dlužníka a poskytnout podklady nezbytné pro vymáhání pohledávek. Na zvláštní žádost společnosti HAZET zveřejní kupující příslušné třetí osobě a taktéž dlužníkovi informace o provedených postoupeních.
- Pokud kupujícímu vzniknou na základě poškození, redukce, ztráty nebo zničení zboží s výhradou vlastnictví nebo z jiných důvodů nároky vůči pojistiteli nebo jiné třetí osobě, budou tyto nároky včetně všech vedlejších práv rovněž předem postoupeny ve stejném rozsahu společnosti HAZET místo výnosu z prodeje.
- Práva vyplývající z výhrady vlastnictví a ze všech zvláštních forem stanovených v těchto podmínkách platí až do úplného uvolnění také pro případné závazky, které jsou společností HAZET doručeny v zájmu kupujícího.
- Kupující nesmí provádět nebo umožnit disponování se zbožím s výhradou vlastnictví, které neodpovídá výše uvedeným podmínkám.
- O zástavách a jiných ohroženích práv společnosti HAZET vycházejících od třetích osob musí kupující okamžitě písemně informovat společnost HAZET se všemi údaji, které jsou potřebné pro žalobu třetí osoby na vyloučení věci z exekuce podle § 771 n. občanského soudního řádu (ZPO). Pokud společnost HAZET utrpí ztrátu z důvodu, že třetí osoba nemůže zaplatit vůči společnosti HAZET vzniklé soudní a mimosoudní náklady žaloby dle § 771 OSŘ, ručí kupující.
- Společnost HAZET je oprávněna zboží s výhradou vlastnictví na náklady kupujícího pojišťovat proti ohni, vodě a krádeži, pokud kupující příslušné pojištění neuzavřel prokazatelně sám.
- Překračuje-li hodnota zajištění včetně možnosti zápočtu zajištěné pohledávky trvale o více než 20 %, je společnost HAZET na žádost kupujícího povinna uvolnit zajištění podle uvážení společnosti HAZET.

VI. Zpětvzetí zboží

- Pokud společnost HAZET není zavázána ke zpětvzetí zboží, vezme HAZET zboží zpět pouze tehdy, pokud je zboží aktuální, v originálním obalu a schopné zpětného prodeje a pokud společnost HAZET předem písemně souhlasila se zpětvzetím. Zpětné zasílání musí proběhnout bezplatně.
- Dobropis pro zboží vzaté zpět podle A. VI. 1. se provede s 80 % účtované ceny. Náklady na případné zpracování a nové zabalení budou navíc kráceny. Zaúčtování dobropisu lze provést pouze s novými dodávkami zboží. Izolované nářadí zásadně nelze z bezpečnostních důvodů brát zpět.

B. Dodávky, záruka, odpovědnost

I. Dodací lhůty, termíny dodání

- Společnost HAZET plánované lhůty a termíny pro dodávky a služby platí vždy jenom přibližně, ledaže by byla výslovně slíbena nebo dohodnuta stanovená lhůta nebo stanovený termín.
- Dodací lhůty začínají běžet doručením potvrzení objednávky, avšak nikoliv před úplným vyjasněním všech podrobností zakázky a opatřením případné pořebných tuzemských a zahraničních úředních potvrzení. Dodací lhůty a termíny se vztahují k okamžiku expedice, resp. odeslání ze závodu nebo skladu; jsou považovány za dodržené i v okamžiku ohlášení připravenosti k odeslání, pokud nemohlo být zboží bez zavinění společnosti HAZET odesláno včas.
- Dohodnutá dodací lhůta se prodlužuje, nehlédě na práva společnosti HAZET vyplývající z prodlení kupujícího, o dobu, během které je kupující v prodlení se svými závazky vyplývajícími z uzavření této nebo jiné smlouvy, plus o průměrnou dobu zvěžení.
- Dílčí dodávky jsou přípustné, pokud jsou pro kupujícího únosné. Každá dílčí dodávka platí jako samostatný obchod.
- Společnost HAZET je oprávněna zadržet stávající dodávky, pokud kupující nesplní svoje platební závazky nebo pokud existuje odůvodněná obava, že je nemůže splnit (zadržovací právo). Společnost HAZET si v každém případě vyhraduje dodávku proti platbě předem nebo na dobírku.
- Dodavatelský závazek HAZET je s výhradou správného, včasného a vlastního smluvního dodání, ledaže by bylo nesprávné nebo opožděné vlastní dodání dluženo společností HAZET.
- Když je společnost HAZET v prodlení s dodáním nebo jinou službou, může kupující kromě služby požadovat náhradu škody z prodlení; při mírném nedodržení však omezenou na nejvýše 10 % z dohodnuté ceny za opožděnou dodávku nebo službu. Právo kupujícího na náhradu škody místo služby podle pravidla B. VII. 1. a B. VII. 2. zůstává nedotčeno.



II. Zvláštní podmínky při dohodnutých odvolávkách

1. U smluv s průběžnými dodávkami je nutné odevzdat společnosti HAZET odvolávky a rozvržení podle druhů pro přibližně stejné měsíční množství. Nedojde-li k včasné odvolávce nebo rozvržení, pak je společnost HAZET po neúspěšném stanovení náhradní lhůty oprávněna sama zboží rozvrhnout a poslat nebo odstoupit od zbývajících částí dohody a požadovat místo plnění náhradu škody.

III. Vyšší moc a jiné překážky v dodávce

1. Události vyšší moci, jako například stávka, vyluka, mobilizace, válka, blokáda, pandemie nebo epidemie, dovozní a vývozní zákazy, nedostatek surovin a paliv, požár a jiné okolnosti, za které společnost HAZET nenesu vinu a které značně omezují dodávku nebo služby společnosti HAZET, opravňují společnost HAZET k posunutí dodávky o dobu trvání překážky a přiměřenou dobu na přípravu. To platí bez ohledu na to, zda shora uvedené okolnosti nastaly u společnosti HAZET, u předchozích dodavatelů nebo u subdodavatele.
2. Kupující může od společnosti HAZET požadovat vysvětlení, zda dodá zboží během přiměřené lhůty, nebo zda chce odstoupit od smlouvy. Nevysvětlí-li se společnost HAZET v přiměřené lhůtě, pak může kupující od ještě nesplněné části dodávky odstoupit.
3. Prohlášení subdodavatele odevzdané společnosti HAZET o okolnostech, které u něj nastaly, podle B.III.1. platí jako dostatečný důkaz, že společnost HAZET nemůže dodat zboží bez vlastního zavinení. 1. platí jako dostatečný důkaz, že společnost HAZET nemůže dodat zboží bez vlastního zavinení.

IV. Přeprava a přechod rizik

1. Speditéra nebo přepravce určí společnost HAZET. Není-li zvlášť dohodnuto jinak, je způsob přepravy a přepravních prostředků ponechán na volbě společnosti HAZET, a to za vyloučení jakékoliv záruky.
2. Zboží připravené k expedici k dohodnutému termínu musí být okamžitě vyžádáno k dodání. V opačném případě je společnost HAZET oprávněna skladovat zboží na náklady a riziko kupujícího dle svého uvážení a fakturovat je jako zaslání ze závodu nebo skladu. U dodávky bez poplatků za přepravu musí být přepravní prostředek okamžitě vyložen. Čekací dobu hrají vždy kupující.
3. Pokud není dohodnuto nic jiného, bude provedena dodávka „ze závodu“. Předáním přepravci či dopravci, nejpozději však opuštěním závodu či skladu – i v případě dodávky bez dopravného – přechází riziko v každém případě, včetně rizika zabavení, na kupujícího.
4. Únosné předčasné dodávky a obvyklé zvýšené nebo snížené dodávky jsou přípustné.
5. U speciálních zakázek smí být množství objednávkou nižší nebo vyšší max. o 10 %. Za zakázkovou výrobu se považují rovněž sériové výrobky, které mají být na výslovné přání kupujícího speciálně označeny. Zakazník nesmí odstoupit od smlouvy. Zboží nebude společností HAZET vzato zpět.

V. Závady a záruka

1. Pokud má dodané zboží věcný nedostatek, je společnost HAZET během přiměřené lhůty dle volby společnosti HAZET nejprve oprávněna k vylepšení nebo dodatečné dodávce.
2. Kupující musí obdržené zboží zkontrolovat okamžitě po dodání. Nároky ze závad existují pouze tehdy, když jsou závady okamžitě reklamovány, nejpozději ale do 7 dnů v textové formě, skryté věcné závady musí být reklamovány v textové formě okamžitě po jejich objevení. Škody vzniklé při přípravě a zjevné vady musí navíc kupující okamžitě nahlásit příslušnému speditérovi, dopravci, resp. přepravci nebo poště a rovněž společnosti HAZET.
3. Pokud byla dohodnuta přejímka zboží nebo zkouška prvního vzorku, je kupující zavázán k pečlivé kontrole při přejímce nebo zkoušce prvního vzorku. Zkouška prvního vzorku nezabývá kupujícího vstupní kontroly sériových dílů. Při dodání sériových dílů je vyloučena reklamáce závad, které kupující mohl zjistit při pečlivé zkoušce prvního vzorku.
4. HAZET je dána příležitost, stanovit reklamované závady. Reklamované zboží je třeba na vyžádání okamžitě zaslat zpět společnosti HAZET; HAZET přebírá náklady na přepravu, když je reklamáce závad oprávněná. Když kupující těmto závazkům nedostojí nebo bez souhlasu společnosti HAZET provádí změny na již reklamovaném zboží, ztrácí případné nároky z věcných nedostatků.
5. Za závady, které vzniknou nevhodným nebo neodborným používáním, chybnou montáží příp. uvedením do provozu kupujícím nebo třetími osobami, běžným opotřebením, chybným nebo nedbalým zacházením, společnost HAZET neručí stejně tak jako za důsledky změn neodborně provedených kupujícím nebo třetími osobami nebo prací na opravách bez souhlasu společnosti HAZET.
6. Zákonné regresní nároky kupujícího vůči společnosti HAZET platí jen v případě, že kupující neuzavřel se svým odběratelem žádné dohody přesahující zákonné nároky na základě odpovědnosti za vady.
7. Výše případné náhrady vykonané v rámci B.V.6. je omezena na vlastní náklady (např. náklady na přepravu a materiál) kupujícího, nikoliv však na jeho ziskovou marži vůči jeho odběrateli.
8. Další nároky kupujícího vůči společnosti HAZET a jejím asistentům při plnění na základě věcných vad jsou s výhradou ustanovení podle B.VI. těchto obchodních podmínek vyloučeny.
9. HAZET ručí za to, že zboží dodané společností HAZET je bez obchodních ochranných práv a/nebo autorských práv třetích osob. HAZET se zavazuje, kupujícího v rámci zákonných předpisů osvobodit od nároků, které uplatní třetí osoby kvůli porušení obchodních ochranných práv a/nebo autorských práv patřících jim ve Spolkové republice Německo. Předpokladem k osvobození je, aby nároky třetích osob byly buď uznány společností HAZET nebo byly soudně pravomocně stanoveny.
10. Kupující umožní společnosti HAZET, aby se HAZET na vlastní náklady podílela na právní obhajobě proti takovým nárokům třetích osob, především proti tzv. vedlejší intervenci ve smyslu civilního soudního řádu. Kupující bude společnost HAZET v přiměřeném rozsahu podporovat při přípravě a provádění právní obhajoby příp. srovnávacího jednání. Společnost HAZET kupujícímu uhradí veškerá nutná vydání v souvislosti s právní obhajobou proti tomuto uplatňování nároků, přičemž náklady na právní zástupce budou hrazeny na základě zákona o odměnách za práci právních zástupců („RVG“).

11. Předpokladem pro výše uvedené nároky kupujícího vůči společnosti HAZET je, že
 - a) kupující neprodleně písemně informuje společnost HAZET, když ohledně dodaného zboží budou vůči kupujícímu uplatňovány nároky kvůli porušení ochranných práv a/ nebo autorských práv třetích osob,
 - b) kupující společností HAZET přenechá kontrolu právní obhajoby a v rámci právní obhajoby a/nebo při srovnávacích jednáních bude vždy jednat pouze v souladu se společností HAZET a
 - c) domnělé porušení práva je výhradně třeba přičíst zboží dodanému společností HAZET bez spojení nebo použití s jinými produkty.

VI. Záruka

1. Nezávisle na právech z věcných nedostatků náležejících příp. kupujícímu podle B. V., společnost HAZET poskytuje na veškeré nářadí plnou záruku ohledně materiálových a výrobních vad. Z plné záruky jsou vyloučeny adaptéry. Plná záruka u nástrčných klíčů u strojní manipulaci se omezuje na materiálové příp. výrobní vady. Do záruky nespadá normální opotřebení a/nebo únavový lom nářadí a opotřebitelných dílů. Z plné záruky je rovněž vyloučeno nářadí, které již není funkční z důvodu vysokého stáří nebo použití v rozporu s předpisy či stanoveným účelem. V této souvislosti je třeba zohlednit příslušné návody k obsluze a bezpečnostní předpisy pro nářadí HAZET. Také je třeba zohlednit obecné bezpečnostní předpisy a také údaje v příručce nářadí HAZET. O použití nářadí v rozporu se stanoveným účelem se jedná především při:
 - překročení normální nebo předepsané zatížitelnosti nářadí (například při použití bočního nože na příliš tvrdý drát nebo u majlíků, důlčků nebo průbojníků, které jsou použity u příliš tvrdé oceli nebo pro těžké práce).
 - dalším používáním nářadí, které je již částečně poškozené nebo defektní.
 - ovládání šroubů nebo matic pomocí nástrčných klíčů nesprávné velikosti.
 - pozměnění nářadí.
 - použití nástrčných klíčů určených pro ruční manipulaci u rázových utahováků.
 - nevhodném používání nářadí (např. použití šroubováků jako dláto nebo páka atd.).
2. K uplatnění práva na záruku zašle kupující při výskytu materiálové nebo výrobní vady nářadí s uhrazeným poštovním přes specializovaný obchod společnosti HAZET. HAZET překontroluje nářadí. Při výskytu materiálové nebo výrobní vady, nahradí společnost HAZET zboží nebo zboží bezplatně opraví.

VII. Odpovědnost

1. Kvůli porušení smluvních a mimosmluvních závazků, především kvůli nemožnosti, prodlení, zavinení při přípravě smluv a nepovolenému jednání ručí HAZET pouze v případech úmyslu a hrubé nedbalosti. Při hrubé nedbalosti je ručení HAZET omezeno na typické smluvní škody předvídatelné při uzavírání smlouvy.
2. Omezení ručení z B. VII. 1. neplatí při zaviněném porušení zásadních smluvních závazků, pokud je ohroženo dosažení účelu smlouvy, při zaviněném přivození smrtelných úrazech, úrazech a poškození zdraví a také tehdy ne, když a pokud společnost HAZET převzala záruku za stav zakoupené věci, a rovněž v případech nuceného ručení podle zákona o ručení za výrobky. Podstatné jsou takové smluvní závazky, které teprve vůbec umožňují řádné provádění smlouvy a její dodržování a na jejíž dodržování kupující může pravidelně spoléhat. Změna důkazního břemene v neprospěch kupujícího není spojena s výše uvedenými ustanoveními.
3. Pokud je ručení společnosti HAZET vyloučeno nebo omezeno, platí to také pro osobní ručení zaměstnanců, pracovníků, spolupracovníků, zákonných zástupců a pověřenců společnosti HAZET.
4. Pokud kupující je ze zákona povinen, kvůli vadě zaviněné HAZET u zboží vyrobeného a dodaného společností HAZET provést akci stažení zboží a pokud by HAZET ve vnějším vztahu proto sama ručila, nese společnost HAZET náklady spojené s akcí stažení zboží pouze tehdy, pokud jsou opatření a náklady přiměřené a nutné, není k dispozici žádný mimější stejně účinný prostředek k odvrácení nebezpečí a pokud byla tato vada před vznikem případných nákladů odsouhlasena se společností HAZET. Námitka společnosti HAZET ke spoluzavinení zůstává nedotčena.
5. Pokud není dohodnuto jinak, jsou smluvní nároky, které kupujícímu vniknou vůči společnosti HAZET z podnětu a v souvislosti s dodávkou zboží, promlčeny jeden rok po dodání zboží. To neplatí, pokud §§ 438 odst. 1 č. 2, 478, 479 nebo § 634 a odst. 1 č. 2 občanského zákoníku předepisují delší lhůty a také v případech smrtelných úrazů, úrazů u poškození zdraví, při úmyslném a hrubé nedbalém porušení závazků námi nebo při zaviněném zatajení závady. V případech nedostatečného dodatečného plnění nezačíná znovu promlčecí lhůta. Zákonná ustanovení k důkaznímu břemenu zůstávají nedotčena.

C. Závěrečná ustanovení

1. Jako místo plnění a výhradní soudní příslušnosti pro všechny spory vyplývající přímo nebo nepřímo z tohoto smluvního vztahu je určen Remscheid.
2. Právní vztah mezi společností HAZET a kupujícím podléhá výhradně právu Spolkové republiky Německo s vyloučením příslušného tuzemského mezinárodního kolizního práva, zejména Úmluvy OSN o smlouvách o mezinárodní koupi zboží ze dne 11. dubna 1980 (CISG).
3. Jsou-li nebo budou-li jednotlivá ustanovení těchto obchodních podmínek zcela nebo z části neplatná, zůstává tímto platnost ostatní části nebo ostatních ustanovení nedotčena.



Environmentální management

Látky ohrožující vodní prostředí (např. kyseliny, louhy, oleje, chladiva, maziva a jiné) se snažíme eliminovat, popř. skladovat a používat tak, aby nedošlo ke škodám na životním prostředí. Odváděné odpadní vody musejí být čisté. Emise, které náš podnik vypouští, nesmí způsobit žádné újmy životnímu prostředí ani lidem. Šetrné zacházení se zdroji a aktivní ochrana životního prostředí jsou součástí naší podnikatelské zodpovědnosti.

Spotřeba přírodních zdrojů

Podniková preventivní ochrana životního prostředí pro nás znamená komplexně sledovat, analyzovat a zlepšovat podnikové procesy. Jen šetrné zacházení s okolním prostředím při výrobě a poskytování služeb může snížit zatížení našeho životního prostředí.

Dodržování právních předpisů, nepřetržité zlepšování

Zavazujeme se dodržovat úřední nařízení, zákony a předpisy, a navíc neustále zlepšovat ochranu životního prostředí v rámci podniku. Všechna naše opatření na ochranu životního prostředí jsou orientována na nejlepší dostupné a ekonomicky aplikovatelné technologie.

Podpora zaměstnanců

Úspěchů v ochraně životního prostředí lze dosáhnout pouze s aktivní podporou všech zaměstnanců. Proto se snažíme každého zaměstnance dostatečně informovat a vzdělávat, aby mohl v této oblasti aktivně spolupracovat.

Aktivní práce s veřejností

Snažíme se vést s obchodními partnery, sousedy, úřady a zainteresovanou veřejností otevřený a věcný dialog o ekologických zátěžích naší společnosti a nebráníme se podnětům na zlepšení.

Nákup

Při pořizování našich surovin a pomocných látek dodržujeme ekologická kritéria a preferujeme dodavatele, kteří kladou podobný důraz na ochranu životního prostředí jako my.

Kontrola

Pravidelně kontrolujeme a posuzujeme dopady našeho podniku na životní prostředí a rovněž dosažení našich stanovených cílů, které vždy přizpůsobíme nově získaným poznatkům.





Zastoupení a prodejní kanceláře společnosti HAZET v Německu

HAZET-WERK
Hermann Zerver GmbH & Co. KG
Postanschrift:
100461
42804 REMSCHEID
Hausanschrift:
Güldenwerther Bahnhofstr. 25-29
42857 REMSCHEID
☎ +49(0)2191/792-0
☎ Inland +49(0)2191/792-375
☎ Export +49(0)2191/792-400
www.hazet.de
e-mail info@hazet.de

Verkaufsbüro West
☎ +49(0)2191/792-231
☎ +49(0)2191/792-375
www.hazet.de
e-mail kevin.ankermann@hazet.de

Verkaufsbüro Südwest
☎ +49(0)2191/792-406
☎ +49(0)2191/792-375
www.hazet.de
e-mail christopher.schrouven@hazet.de

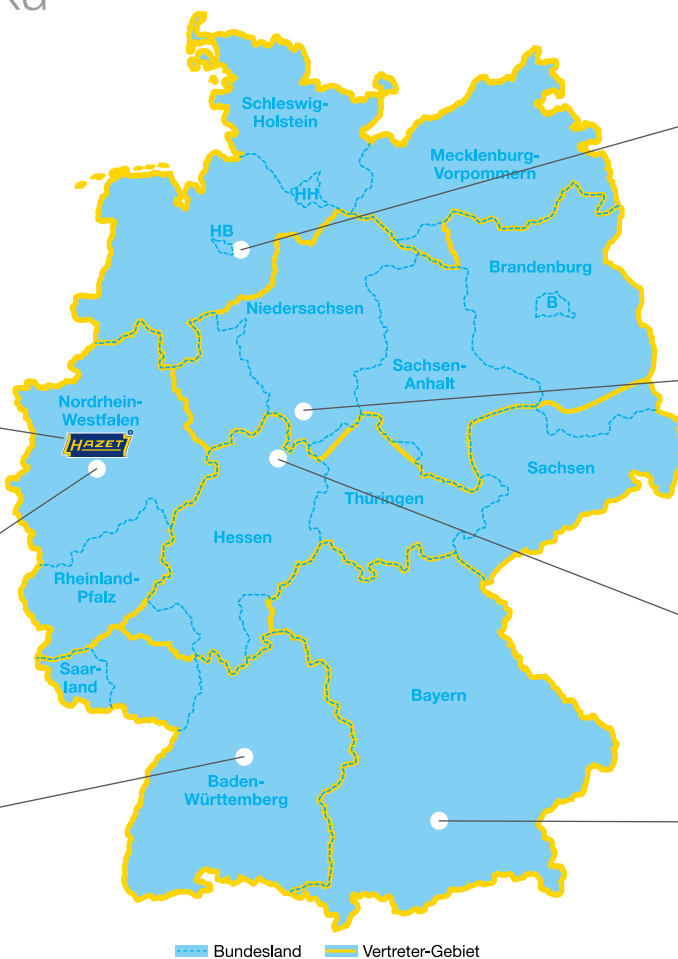

Verkaufsbüro Nord
☎ +49(0)2191/792-425
☎ +49(0)2191/792-375
www.hazet.de
e-mail sarah.pilgrim@hazet.de

Wenzel GmbH
Altendorfer Tor 23
37574 Einbeck
Postfach 18 41
37559 Einbeck
☎ +49(0)5561/9342-0
☎ +49(0)5561/9342-30
e-mail info@wenzeleinbeck.de

Verkaufsbüro Mitte
☎ +49(0)2191/792-229
☎ +49(0)2191/792-375
www.hazet.de
e-mail tim.wagner@hazet.de

Verkaufsbüro Süd
☎ +49(0)2191/792-272
☎ +49(0)2191/792-375
www.hazet.de
e-mail kevin.scharwaechter@hazet.de

Dodání jen prostřednictvím specializovaného obchodu HAZET.
Uvedená zastoupení jsou k dispozici pro poskytnutí informací a poradenství.

Záruka HAZET



Veškeré nářadí HAZET podléhá při výrobě přísné kontrole a před expedicí se velmi důkladně prověřuje z hlediska materiálových a výrobních vad.

Společnost HAZET poskytuje na veškeré nářadí plnou záruku ohledně materiálových nebo výrobních vad.

Zašlete nám, prosím, vaše nářadí při výskytu materiálových nebo výrobních vad bezplatně do naší firmy prostřednictvím vašeho specializovaného prodejce.

Po provedení kontroly vám nářadí bezplatně vyměníme nebo opravíme, pokud se jedná o materiálovou nebo výrobní vadu.

Z plné záruky jsou vyloučeny všechny adaptéry.

Plná záruka u nástrčných klíčů pro strojní manipulaci se omezuje na materiálové a výrobní vady.

Do záruky nespádá normální opotřebení a únavový lom nářadí a opotřebitelných dílů.

Z této plné záruky je rovněž vyloučeno nářadí, které již není funkční z důvodu vysokého stáří nebo použití v rozporu s předpisy či stanoveným účelem.

V této souvislosti je nutné zohlednit příslušný návod k obsluze a bezpečnostní předpisy našich výrobků. Dodržujte přitom také všeobecné bezpečnostní pokyny uvedené na této stránce a údaje v katalogu nářadí HAZET.

Níže je uvedeno několik příkladů, které jsou považovány za použití v rozporu se stanoveným účelem:

- Překročení běžné nebo předepsané zatížitelnosti nářadí, např.
 - použití kleští na drát na příliš tvrdý drát
 - použití dláta, důlkovače nebo průbojníku na příliš tvrdé oceli nebo pro příliš těžké práce.
- Další používání nářadí, které je již částečně poškozené nebo defektní.
- Ovládání šroubů nebo matic pomocí nástrčných klíčů nesprávné velikosti.
- Nářadí, které bylo změněno.
- Použití nástrčných klíčů určených pro ruční manipulaci s rázovými utahovými.



Vyměníme každé nářadí, které má materiálovou nebo výrobní vadu (viz také naše prodejní, dodací a platební podmínky).



U společnosti HAZET klademe velký důraz na ochranu životního prostředí.

Tento katalog je například vytištěn na ekologickém papíře, který nebyl bělen chlorem.

Společnost HAZET je certifikována podle norem DIN EN ISO 14001
0410430403
DIN EN ISO 9001
0410030403





Závod 1 · Remscheid-Güldenwerth



Závod 2 · Heinsberg



Závod 3 · Remscheid-Vieringhausen



Závod 4 · Remscheid-Vieringhausen



Partner
Raeder Motorsport



Oficiální partner okruhu
Nürburgring



Oficiální dodavatel vybavení
pro MERCEDES-BENZ
Global TechMaster



PORSCHE
MOTORSPORT

OFICIÁLNÍ DODAVATEL
VYBAVENÍ



Online-Katalog:
<https://www.hazet.de/de/produkte>



facebook:
<https://www.facebook.com/hazetwerk/>



youtube:
<https://www.youtube.com/user/HAZETWERK>



Instagram:
https://www.instagram.com/hazet_1868_official/



FSC
www.fsc.org
MIX
Papier aus verantwortungsvollen
Quellen
FSC® C075521



Das Werkzeug



4 000896 237401

WHP21/CS/CZ/1.1.10/2020/5. myview HZ-6577/M6